

# inwood

OFFICE  
ENVIRONMENTS

## price list

effective 01 january 2012

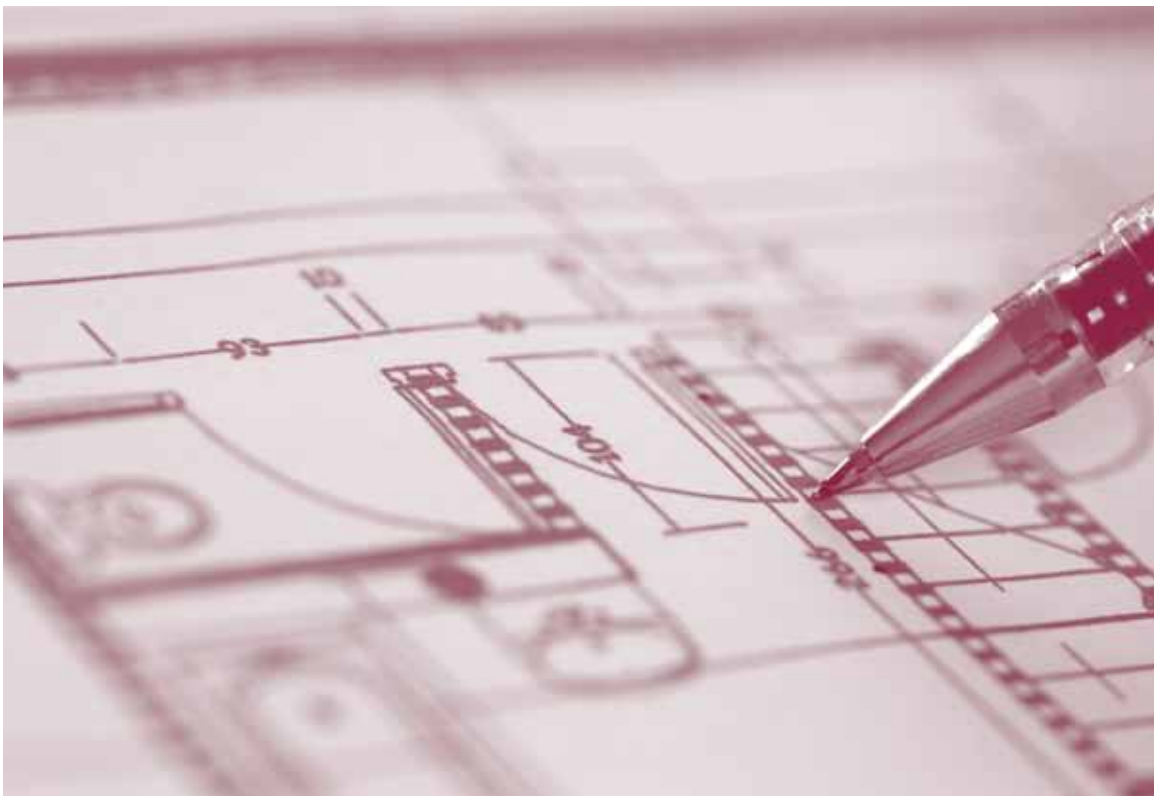

account # \_\_\_\_\_  
discount \_\_\_\_\_  
zone \_\_\_\_\_  
c.s.r. \_\_\_\_\_  
sales rep. \_\_\_\_\_

reception  
casegoods  
conference  
seating

zones one and two



general information page 4

welcome page 6



muse page 34



progeny page 54



trek page 76



brio page 116



ovation/bravo page 174



veer page 208



ebb page 224



ashton page 240



oxford page 260



monticello/empire page 278



magnus page 302



presentation and conference page 320  
storage units page 326  
base specifier page 334  
table tops page 338  
table bases page 344



seating page 358



computer and electronic accessories page 370



<b>casegoods price list</b> .....	Page #	
general information & terms.....	4	
<b>welcome series</b>		
specifications .....	8	
guide to specify.....	9	
sample typicals .....	10	
component pieces		
square center sections.....	16	
curved center sections.....	18	
towers.....	20	
corners .....	22	
run-offs.....	24	
accessories .....	32	
<b>muse series</b>		
specifications .....	36	
desks .....	38	
credenzas .....	39	
extension tops.....	40	
single pedestal desks.....	40	
returns .....	41	
bridges .....	42	
single pedestal credenzas.....	42	
case hung overheads.....	44	
wall hung overheads .....	45	
case towers .....	46	
storage components .....	47	
tack panels.....	49	
tables.....	50	
accessories .....	50	
transaction counters .....	51	
<b>progeny series</b>		
specifications .....	56	
desks .....	58	
credenzas .....	59	
single pedestal desks.....	60	
corner units .....	65	
extension tops.....	65	
returns .....	66	
bridges .....	67	
single pedestal credenzas.....	67	
overhead storage units.....	70	
storage components .....	72	
towers.....	73	
bookcases .....	75	
tables.....	75	
<b>trek series</b>		
specifications .....	78	
tops for worksurfaces .....	80	
tops for bridge/returns .....	82	
d shaped tops .....	82	
bow shaped tops .....	82	
p shaped tops .....	84	
angled return tops.....	84	
arc tops .....	86	
counter tops.....	86	
tops for lateral files.....	86	
bookcase tops.....	86	
counter chassis .....	88	
under worksurface storage .....	88	
lateral files .....	90	
end supports .....	92	
t supports .....	92	
<b>trek series (continued)</b>		
modesty panels .....	94	
overhead wall hung storage.....	100	
overhead storage units.....	100	
storage components .....	104	
bookcases .....	110	
tables.....	110	
grommet placement .....	114	
<b>brío series</b>		
specifications .....	118	
desks .....	120	
desks with laptop pedestals .....	121	
credenzas .....	122	
extension tops.....	124	
single pedestal desks.....	126	
returns .....	130	
bridges .....	130	
single pedestals credenzas.....	132	
overhead wall hung storage.....	134	
casehung overheads.....	138	
overhead storage units.....	142	
storage components .....	150	
case towers .....	154	
bookcases .....	158	
tables.....	160	
transaction counters .....	164	
track panels.....	172	
<b>ovation/bravo series</b>		
specifications .....	176	
desks .....	178	
credenzas .....	179	
single pedestal desks.....	182	
bullet tops.....	186	
corner units .....	187	
returns .....	187	
bridges .....	190	
single pedestal credenzas.....	190	
overhead wall hung storage.....	196	
overhead storage units.....	196	
hutches and cabinets.....	200	
storage components .....	202	
printer stands .....	202	
bookcases .....	203	
transaction counters .....	205	
tables.....	207	
<b>veer series</b>		
specifications .....	210	
desks .....	212	
credenzas .....	213	
single pedestal desks.....	214	
single pedestal credenzas.....	216	
bridges .....	217	
overhead wall hung storage.....	218	
overhead storage units.....	218	
hutches and cabinets.....	220	
towers.....	221	
bookcases .....	222	

<b>ebb series</b>	
specifications .....	226
desks .....	228
credenzas .....	228
single pedestal desks.....	229
corner unit .....	230
returns .....	230
bridges .....	231
single pedestal credenzas.....	231
overhead wall hung storage.....	233
overhead storage units.....	233
storage components .....	235
bookcases .....	237
transaction counters .....	238
tables.....	239
<b>ashton series</b>	
specifications .....	242
desks .....	244
credenzas .....	244
single pedestal desks.....	246
bullet tops.....	248
p tops .....	248
corner units .....	248
returns .....	248
bridges .....	250
single pedestal credenzas.....	251
overhead wall hung storage.....	252
overhead storage units.....	252
storage components .....	254
printer stands .....	255
tables.....	255
bookcases .....	256
transaction counters .....	257
tables.....	259
<b>oxford series</b>	
specifications .....	262
desks .....	264
table desks .....	264
credenzas .....	264
single pedestal desks.....	266
returns .....	267
bridges .....	267
single pedestals credenzas.....	267
overhead wall hung storage.....	268
overhead storage units.....	269
hutches.....	271
storage components .....	271
bookcases .....	272
transaction counters .....	274
tables.....	275
accessories .....	276
<b>monticello/empire series</b>	
specifications .....	280
desks .....	282
table desks .....	282
credenzas .....	283
single pedestal desks.....	284
returns .....	285
corner units .....	286
returns for corner units.....	286
single pedestal credenzas.....	287
overhead wall hung storage.....	288
overhead storage units.....	288
<b>monticello/empire series (continued)</b>	
hutches and cabinets.....	291
storage components .....	291
printer stands .....	295
bookcases .....	296
transaction counters .....	298
tables.....	299
accessories .....	301
<b>magnus series</b>	
specifications .....	304
desks .....	306
table desks .....	306
credenzas .....	306
single pedestal desks.....	307
returns .....	308
bridges .....	309
single pedestal credenzas.....	309
overhead wall hung storage.....	310
overhead storage units.....	310
hutches and cabinets.....	312
storage components .....	313
bookcases .....	314
transaction counters .....	316
tables.....	317
accessories .....	318
<b>conference</b>	
specifications .....	322
grain directions chart .....	323
seating chart per table size.....	324
storage components .....	326
accessory components.....	330
pointman wall unit .....	332
base specifier .....	334
top shapes.....	338
bases .....	344
podiums.....	354
<b>seating</b>	
specifications .....	360
mayer fabrics.....	361
momentum fabrics .....	362
guest seating .....	363
lounge seating.....	364
task seating .....	368
swivel executive/management.....	368
<b>accessories</b> .....	370

## product warranty

Inwood Office Environments warrants its products to be free from defects in materials and workmanship given normal use and proper care, for a period of **twenty (20) years** of single shift service. Specific components are warranted to be free from defects in materials and workmanship for the following periods of time from the date of initial shipment:

<b>electrical components</b>	two (2) years
<b>pneumatic cylinders</b>	three (3) years
<b>control mechanisms</b>	three (3) years
<b>casters</b>	three (3) years
<b>suspensions</b>	(lifetime)

Fabrics will be covered only by the warranty of the original manufacturer. Inwood tenders this warranty only to original purchasers acquiring our products through those parties specifically authorized by Inwood to sell our products. Repair and/or replacement, at our option, will be made on any part or parts found to be defective within the terms of the warranty. The warranty shall not include any labor or shipping costs for replacement of any such parts or materials.

*This warranty does not cover nor is Inwood responsible for:*

- Damage(s) caused by a transportation company
- Damage(s) resulting from user modification, alterations, misuse, abuse or negligent use of our product
- Inwood does not recommend any glass overlays on any tops. The weight of glass may cause tops to warp, or prevent proper air or humidity circulation or natural expansion and contracting and thus cause veneers or finish to fail. Any and all overlays void all warranties."
- Damage(s), defect(s), or product failure(s) due to customers request for modifications to product design, product dimensions, product arrangement or normal product specifications
- Natural variations in color, grain, or texture of wood and other covering materials over which Inwood has no control
- Wearing or cuts to covering materials
- Customer's Own Materials (COM)
- Finish variations which naturally occur in cherry wood or cheery veneer due to age or exposure to light. The patina which develops in cherry products lends to the natural beauty of the wood, but also makes it difficult to provide an exact finish match on items which may have been previously ordered from Inwood.

*Inwood does not make any other warranties except as expressly set forth above, either expressed or implied, including any warranty of merchantability or fitness for any particular purpose. Inwood shall not be liable for consequential or incidental damages under this warranty. Further, Inwood makes no warranties, expressed or implied, for improper assembly and/or installation of its products.*

## order procedure

Inwood does not accept orders verbally.

Orders may be faxed, e-mailed or mailed directly to:

Inwood Office Environments  
PO Box 646  
Jasper, IN 47546  
Fax: 812.482.9732  
E-mail: inwood@inwood.net

All orders from authorized & credit-approved Inwood Office Environments dealers must be in writing and must include the following information:

Date  
Purchase Order Number  
Bill to Address  
Ship to Address  
Special Shipping Instructions (delivery notification, special ship dates, ship complete or split shipments, and tags if applicable)  
Complete Model Numbers (include finish & fabric numbers)  
Net Price  
Requested Delivery Date (if applicable)

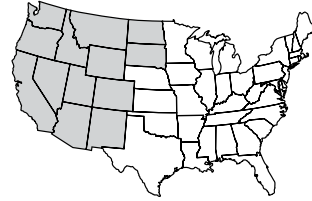

## order confirmation

All complete orders will be entered and acknowledged promptly with approximate shipping date(s), transit times, and other pertinent information. This acknowledgement is the final agreement between Inwood and the customer, superseding all previous communications regarding the order. *NOTE It is the customer's responsibility to check the acknowledgment for accuracy. Please advise Inwood immediately of any discrepancies.*

## changes and cancellations

Because many of our casegood products and all of our seating products are made to order, we must limit customer changes and cancellations. We regret that changes and cancellations are not possible once production has begun. Production normally begins 48 hours after receipt of order. Orders for standard casegood products with in-stock finishes may be cancelled for a 30% restocking fee. Any non-stock finish is considered made to order and cannot be changed or cancelled. Any fabrics orders will not be able to be cancelled once the order for the fabric has been placed and cut.

## delivery information

Shipments are FOB destination for the 48 contiguous states. Orders are priced by destination zone as listed by state.

### zone 1

Alabama, Arkansas, Connecticut, Delaware, Florida, Georgia, Illinois, Indiana, Iowa, Kansas, Kentucky, Louisiana, Maine, Maryland, Massachusetts, Michigan, Minnesota, Missouri, Nebraska, New Hampshire, New Jersey, New York, North Carolina, Ohio, Oklahoma, Pennsylvania, Rhode Island, South Carolina, Tennessee, Texas, Virginia, West Virginia and Wisconsin.

### zone 2

Arizona, California, Colorado, Idaho, Montana, Nevada, New Mexico, North Dakota, Oregon, South Dakota, Utah, Washington and Wyoming.

[ QS ] indicates this item in referenced finish available for 48 hour shipment. Customer must indicate "QS" for each item on each PO. Maximum order quantities per item will apply, please contact customer service to check availability.

## Orders of less than 500 lbs will be assessed a handling charge of \$100.00 net per order.

Inwood reserves the right to select the most appropriate carrier and routing on all shipments. Any charge arising from failure to receive a shipment, rerouting while in transit or carrier storage charges are not included in prices shown and will be billed to the 'sold to' account on the order.

Any order requiring special delivery services will incur additional charges at the time of invoicing. All such requirements must be noted on the purchase order. These are services that are billed to Inwood by the freight company or require the usage of specialized carriers, and not included in the standard price of the product. Examples of such services include:

- **delivery notification or call ahead requests**  
\$10 Net Charge
- **inside delivery**  
minimum \$100 Net Charge
- **non dock delivery**  
minimum \$100 Net Charge
- **weekend delivery (friday after 4:00pm-sunday night)**  
minimum \$500 Net Charge
- **residential delivery**  
Customer Service may assist you in determining your special delivery requirements and any additional charges that may apply
- **fuel surcharges**  
We will continue to do our best to absorb the increased cost from our transportation vendors; however, if the price of fuel increases above the normal rates, it may require us to pass on the increased costs.

Contact Customer Service if you are unsure if your order requires one or more of the above services. We will make every attempt to avoid additional charges by giving options on what we can do within our standard delivery prices.

All prepaid shipments by Inwood Office Environments will be on carriers of our choice. If you choose to order product FOB Factory, please specify the carrier you require. Product will ship Freight Collect and Inwood's responsibility will cease upon delivery to the carrier.

**order postponements and delivery changes**

Changes may be made to delivery address no later than 5 days before the acknowledged ship date of an order. Contact Customer Service for charges which may be incurred for delivery changes within 5 days of the acknowledged ship date. If it becomes necessary to postpone an order after production has begun, the order will be completed, stored and invoiced to the customer with normal terms. Storage fees of \$2.00 per 100 lbs or \$5.00 minimum per day will occur on all orders that are not picked up or released for shipment after 10 working days from the acknowledged ship date.

**claim process for merchandise damage/shortage/carrier delay**

All products produced by Inwood are carefully inspected and properly packed prior to shipment. All shipments are delivered to the transportation company in good condition. If you receive a shipment that has damage, product shortage, or delivery has been delayed by the carrier, the following steps must be taken:

- Before signing for any merchandise, make notation of all visible damage, shortages, and/or time of truck arrival on the freight bill (bill of lading).
- Contact Inwood Customer Service within 15 calendar days of goods receipt to report issue. Legal title to merchandise passes to the buyer upon acceptance by the carrier. We will work with you to file any necessary claims when reported to us within the 15 day time frame.
- Retain all packing materials/cartons for inspection by the carrier agent.

Failure to make any claims against Inwood Office Environments within 15 days shall constitute acceptance of the merchandise and a waiver of any errors or shortages discovered upon inspection.

**repairs and returns**

No repairs or returns will be considered without first obtaining our written permission. Such requests must be made in writing within 15 days of the invoice. Authorization must be obtained from Customer Service prior to repairs being made if Inwood is expected to pay these charges. Charges will be approved only after an estimate has been provided. Credit will be issued only after receipt of repair bills. Made to order items are not returnable. This includes upholstered seating, special items, special finishes, and any non-stock finish. Authorized returns of stock items will be charged a minimum 30% restocking fee. All returns are subject to an attempted pick-up charge of \$200. Please insure that all goods are packed and tagged correctly before calling Inwood for pick up. All RMA's (Return Materials Authorization) will expire within 30 days of notification. Once expired, a new authorization is required for any return. Upon receipt of returned goods, Inwood will inspect and assess responsibility for any defects. If damage of the merchandise was caused by abuse, alteration, or unauthorized repair, we may offer to repair the merchandise for a fee. The final responsibility for determining damage remains with Inwood.

All merchandise must be shipped freight prepaid or we will not accept. All merchandise being returned must be properly packed and protected to insure that no further damage is incurred during transportation back to Inwood.

**specification programs**

- 20/20 Technologies (CAP, GIZA)
- Project Matrix
- Visual Planner

**special construction agreement**

When requested that Inwood Office environments Inc. modify, change or alter its standard product in order to meet the specific needs of Customer, Inwood shall exercise its best efforts to modify its standard product to incorporate the modifications and changes requested by Customer. Inwood Office Environments disclaims any

warranty with respect to the modifications or changes requested by Customer and its standard warranty shall not apply to said modifications or changes. Customer shall have no right to rescind its order of this product after production of the product has begun. Customer assumes the risk of the use of Inwood Office environments product containing the modifications or changes requested by Customer. In no event shall the product containing the modifications or changes requested by Customer be returnable to Inwood Office environments.



**replacement parts**

Contact Inwood Customer Service for item numbers and pricing on replacement parts.

**dimensions**

All dimensions referenced in this book are nominal.

**terms**

Payments are accepted in US Dollars. Payment is also accepted by Visa & Mastercard credit cards, and is posted prior to shipment. When payment is made with a credit card, no additional discounts may be taken.

Prices are effective with the date printed on this price list and supersede all other prices. Orders are accepted at the price in effect on the date the order is received. Possession of this price list does not constitute an offer to sell. Inwood sells to authorized and approved dealers only. Any or all prices, product, and line art are subject to change without notification. Internet or software packages, which support the sale of Inwood products, furnished to the customer either by Inwood or any other source are superseded by revised price lists.

**minimum order**

\$10 US Dollars list price.

Inwood reserves the right to make changes to items here within without notice but will make every effort to give notification of any and all changes.

**standard special upcharges**

Inwood Office environments provides the following standard special modifications to its product. Simply specify the request and add the associated price to list.

to make standard top size shorter or narrower .....	<b>\$298</b>
to change file drawer pedestal in desks, credenzas and modular cabinets to box drawers.....	<b>\$262</b>
to change 2 box drawers in desk to file drawer.....	<b>\$168</b>
to change position of file drawer in desks .....	<b>\$128</b>
to add locks where not standard	
- box, file drawer or center drawer.....	<b>\$67</b>
- hinged door, single .....	<b>\$67</b>
- hinged door, double .....	<b>\$69</b>
to key items alike from factory per unit.....	<b>\$37</b>
to add extra lock per set (including set of keys).....	<b>\$26</b>
extra set of keys (two).....	<b>\$26</b>
to add grommets in any special location .....	<b>\$154</b>
to move standard placement of grommet on unit .....	<b>\$67</b>
grommets (cover only).....	<b>\$26</b>
to add extra shelf for bookcase.....	<b>\$92</b>
to make shelves solid wood.....	<b>Contact customer service for pricing</b>
for typing height return .....	<b>\$237</b>
for non-standard Inwood pulls	
(to change to another series per unit).....	<b>\$86</b>
to flush units together .....	<b>\$137</b>
special finishes (6 item minimum)	
- non-Inwood finishes .....	<b>20%</b>
- standard Inwood finishes .....	<b>15%</b>
- special matte finish.....	<b>15%</b>
finish the back panel on a bookcase.....	<b>\$290</b>
to run a one piece top with grain running long direction:	
- 96" .....	<b>\$1,044</b>
- 120" .....	<b>\$1,167</b>
- 144".....	<b>\$1,565</b>
to add anti-microbial finish (per order).....	<b>\$106 net</b>

# inwood

OFFICE  
ENVIRONMENTS

## price list

effective 01 january 2012

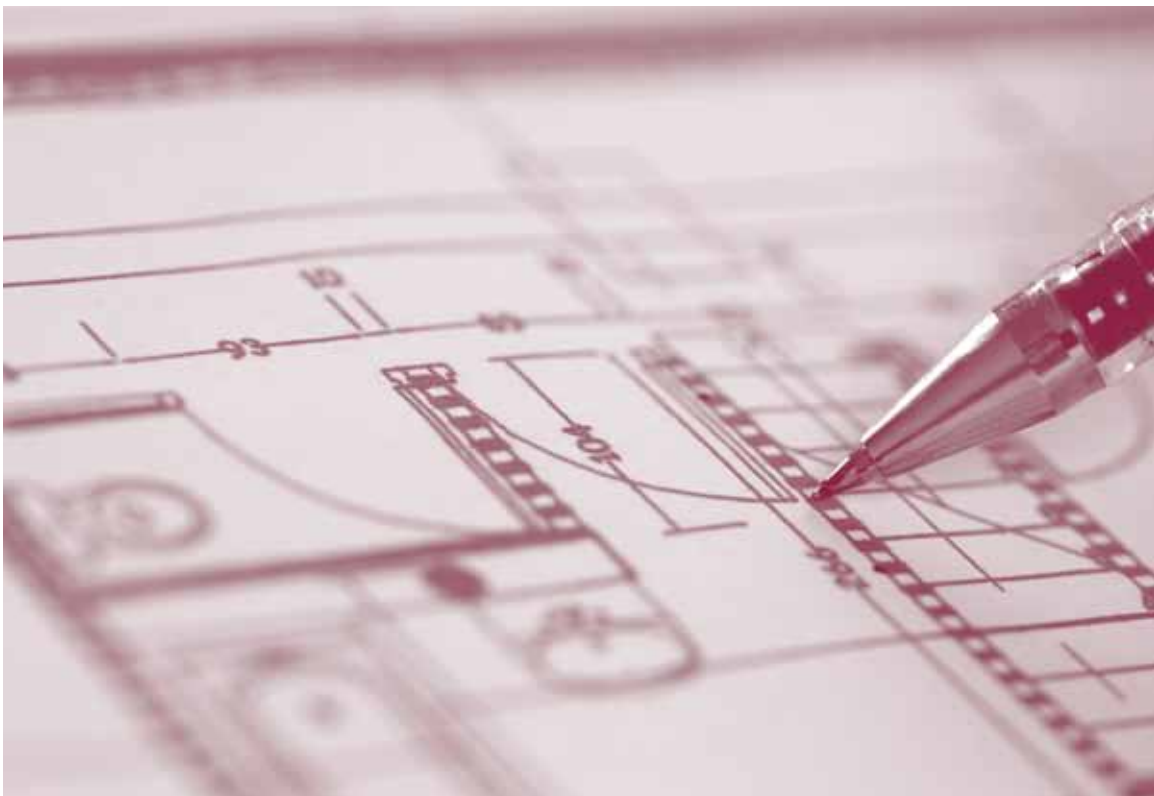

account # \_\_\_\_\_  
discount \_\_\_\_\_  
zone \_\_\_\_\_  
c.s.r. \_\_\_\_\_  
sales rep. \_\_\_\_\_

## welcome

4600/4500

[click here for warranty  
and terms information](#)

zones one and two



# inwood

OFFICE  
ENVIRONMENTS

---

welcome  
4600/4500



### welcome 4600/4500 series specifications

Quality has always been an inherent feature and distinguishing attribute of products crafted by Inwood Office Furniture. Using only the finest in materials and workmanship, Inwood offers a level of quality not commonly found in today's mid-market contract wood office furniture industry.

#### materials:

All wood is thoroughly air and kiln dried to a moisture content not to exceed 8% at the time of assembly.

#### veneers:

All exposed surfaces are plain sliced Cherry, American Black Walnut, White Maple, or Birch Veneer. (Birch veneer has some size limitation). Walnut veneers are carefully book matched. Cherry and Maple veneers are slip-matched. All panels and doors are vertical grain.

#### top work surfaces:

- **high pressure laminate tops** are 1 1/4" thick, 3-ply construction; consisting of a high-pressure laminate work surface and a 45 lb. density flake board core. The under side of the top has a smooth surface Gator-Ply backing sheet. Top rims are 3/4" hardwood with a choice of top edge shape.
- **wood veneer tops** are 1 1/4" thick, 5-ply construction; consisting of 1/40" thick Walnut veneer work surface and a Poplar veneer backing. The top core material is a 45lb density particleboard, with a choice of top edge shape solid wood rim.

#### construction:

Uses a mortise & tenon and glue to join panels. All joints are reinforced with glue blocks.

#### finish:

All Inwood finishes are catalyzed varnish and have excellent durability. Our multi-step satin finishes leave a beautiful natural look to the furniture, and are available in the following finishes: (3L) walnut, (2KL) walnut, (25M) mahogany, (4L) dark mahogany, (25C) cherry, (2ML) natural maple, (3ML) light maple, (4ML) medium maple, (5ML) cherry finish on maple, (6LC) light cherry, (7MC) medium cherry, (8DC) dark cherry, (9BC) burgundy cherry, (25B) ebony.

#### stand-offs:

Stand-offs are also available in laminate, veneer and glass. Avonite™ solid surface may be specified at an upcharge and is available as a top or approach stand-off on square units. Avonite™ is only available as a top stand-off on curved units.

- **laminate approach stand-offs** are applied to an 1/8" flexible plywood. Top stand-offs have solid wood rim.
- **veneer approach stand-offs** are applied to an 1/8" flexible plywood. Top stand-offs have solid wood rim.
- **glass stand-offs** are 3/8" thick clear.

#### additional notes

Top stand-offs in wood and laminate add 2 3/8" to the overall size of the unit. Top stand-offs in glass add 1 1/2" to the overall size of the unit.

For specific sizes of top or approach stand-offs when using C.O.M. material or ordering glass yourself, please contact customer service.

When specifying COM material, customer service must be called to approve desired material in regards to weight, size and workable capabilities.

#### optional hinged door:

An optional locking hinged door can be added to the corner units for \$235 list upcharge per corner section. Please specify on unit.

#### SPL, special laminate:

special laminate may be ordered at a 5% upcharge, plus 75.00 net freight fee- must provide manufacturer and item number. Special laminate designer palette- \$177 list upcharge per stand-off.

#### mixed material stand-offs:

for mixed material stand-offs please call customer service for pricing.

#### edge details:

Optional edge detailing is available on the approach side only to tops. Edge details on stand-offs are as follows:

- curved – approach side only
- square – on all four sides

#### stand-offs:

Additional stand-offs (actual stand-off hardware) \$71 each. Standard silver stand-offs. Black stand-offs available.

#### pulls/grommets:

Pick any inwood pull on mobile pedestals and on storage doors (if specified) Black grommets will be standard. Optional silver available (no upcharge)

#### product warranty

Inwood Office Furniture warrants its products to be free from defects in materials and workmanship given normal use and proper care, for a period of ten (10) years of single shift service. Inwood tenders this warranty only to original purchasers acquiring our products through those parties specifically authorized by Inwood to sell our products. Repair and/or replacement, at our option, will be made on any part or parts found to be defective within the terms of the warranty. The warranty shall not include any labor or shipping costs for replacement of any such parts or materials.

#### This warranty does not cover:

- Damage(s) caused by a transportation company
- Damage(s) resulting from user modification, alterations, misuse, abuse or negligent use of our product
- Natural variations in color, grain, or texture of wood and other covering materials which Inwood has no control
- Wearing or cuts to covering materials

Inwood does not make any other warranties except as expressly set forth above, either expressed or implied, including any warranty of merchantability or fitness for any particular purpose. Inwood shall not be liable for consequential or incidental damages under this warranty.

Further, Inwood makes no warranties, express or implied, for improper assembly and/or installation of its products.

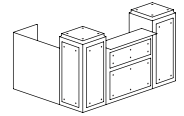

## welcome 4600/4500 series components

- ① ccs center section, curved
- ② cc curved corner (left or right)
- ③ ra run off (ADA accessible) (left or right)
- ④ rp privacy panel (left or right)
- ⑤ as approach stand-off
- ⑥ ts top stand-off

## how to specify:

Start with center section ①, size and finish  
example: 45CCS4844-25M

Add component parts ②, to build unit-  
examples: 45CCL44-25M  
45CCR44-25M

Add run-offs, ③ & ④: options include molding,  
ADA accessibility and privacy panels  
examples: 45R60L (run-off)  
45RA60L (run-off with ADA)  
45R60L-M (run-off with molding)  
-45RP60L (run-off with privacy  
panel) Build unit based on

Build desired look based on options ⑤ & ⑥  
examples: 45CCL44-TS-WH  
45CCL44-AS-WH  
45CCL44-BOTH-WH

Add finish material stand-off options,  
examples: 45CCS4844-25M-TS-SU  
45CCS4844-25M-AS-SU  
45CCS4844-25M-BOTH-SU

**Note:** Components can be used in various  
applications other than the model/description.  
**Ex.:** A center section might be used as a side piece.

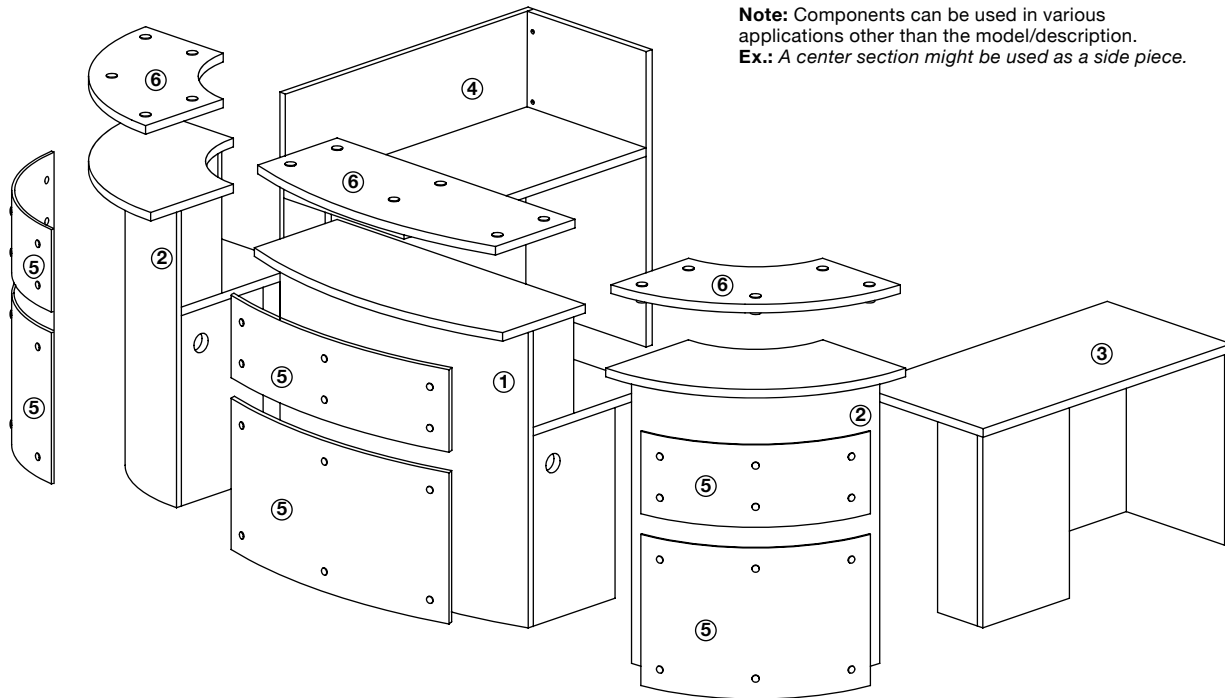



45SCS4844-25M-TS-EW  
45SCS4844-25M-AS-EW  
45SCS4844-25M-BOTH-EW

series - unit identification (section) size - finish - options (molding) - stand-offs - finish  
when ordering Typical's - specify Typical "letter"-finish - finish - stand-off options

welcome  
4600/4500

model number	description	d	w	h	freight	list \$ zone 1	list \$ zone 2
Typical "A"	laminate tops	77	77	44	class 125	7,622	8,234

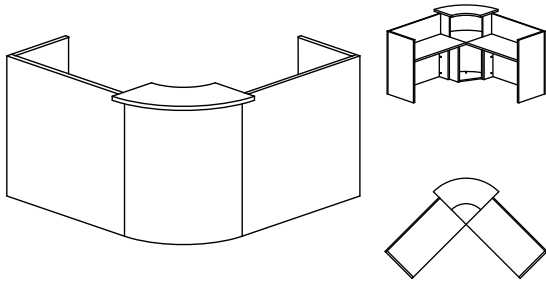

consists of:	d	w	h	quantity
45RP48L privacy panel run off left hand	24	48	43	1
45RP48R privacy panel run off right hand	24	48	43	1
45CCR44 44" curved corner right	29	29	44	1

model number	description	d	w	h	freight	list \$ zone 1	list \$ zone 2
Typical "B"	laminate tops laminate top stand offs	77	77	46.375	class 125	16,303	17,608

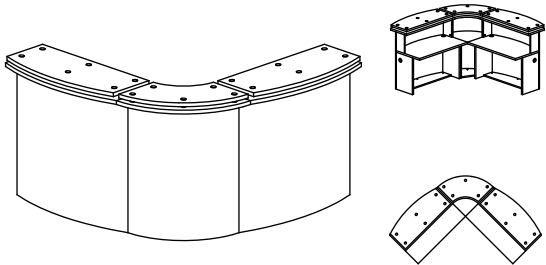

consists of:	d	w	h	quantity
45CCS4844 -TS curved center section	33	48	44	2
45CCL44 -TS 44" curved corner left hand	29	29	44	1

**top material** 45 laminate top veneer top  
46

**TS top stand-off options**  
laminate veneer acrilux glass C.O.M.

**AS approach stand-off options**  
laminate veneer acrilux glass C.O.M.

**avonite™** top & approach stand-offs may be specified with avonite™ call for pricing

**glass stand-offs** custom etching available with as a special with an additional upcharge standard color is silver -optional black available

**edge** edge detail available for approach side only

**chemcast** also available as stand-off. Call for pricing information

**SPL\*** special laminate may be ordered at a 5% upcharge, plus \$77.00 net freight fee- must provide manufacturer and item number

edge



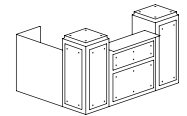

model number	description	d	w	h	freight	list \$ zone 1	list \$ zone 2
Typical "C"	laminate tops no stand offs	106	106	44	class 125	19,046	20,576

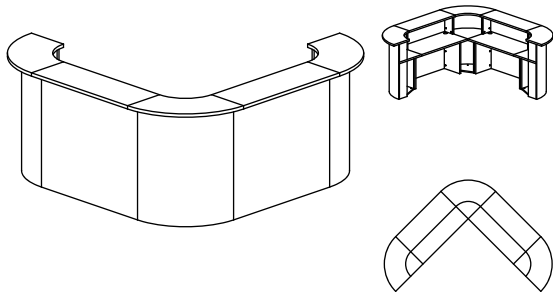

consists of:	d	w	h	quantity
45CCL44 44" curved corner left hand	29	29	44	2
45CCR44 44" curved corner right	29	29	44	1
45SCS4844 square center section	29	48	44	2

model number	description	d	w	h	freight	list \$ zone 1	list \$ zone 2
Typical "D"	laminate tops and laminate top stand offs	77	106	46.375	class 125	19,427	20,983

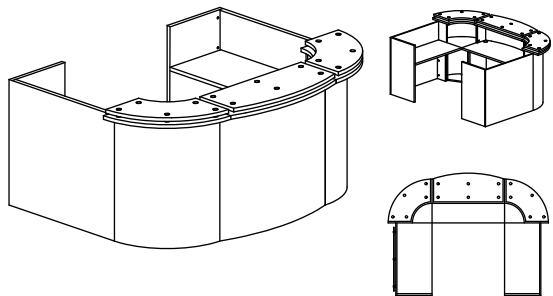

consists of:	d	w	h	quantity
45OCS4844 -TS curved center section	33	48	44	1
45CCR44 -TS 44" curved corner right	29	29	44	1
45CCL44 -TS 44" curved corner left hand	29	29	44	1
45RP48R privacy panel run off right hand	24	48	43	1
45RP48L privacy panel run off left hand	24	48	43	1

laminates	CU	BR	7MC-W
NB-P natural birch on birch	CU curacao fiber	BR butterum granite	7MC-W medium cherry on birch
MB-P mocha on birch	TY thyme fiber	GT graphite swirl	8DC-W dark cherry on birch
CB-P cherry on birch	CO coriander fiber	BF black faux marble	3L-W saddle on walnut
3L-P saddle on walnut	BA black ashwood	LH light hammer copper	2KL-W sepia on walnut
4L-P dark mahogany on walnut	GV galvan	CP copper maple leaves	4L-W dark mahogany on walnut
25M-P mahogany on walnut	GS graphite spektrum	CE celery fiber	25M-W mahogany on walnut
25B-P ebony on walnut	NV negotiating in geneva	AS alumasteel	25B-W ebony on walnut
2ML-P natural maple on maple	NV-G negotiating in geneva gloss	SPL Designer palette* (\$179 list upcharge per stand-off)	25C-W cherry on walnut
3ML-P light maple on maple	OS olive serenity	MR mercury stria	1NC-W natural cherry on cherry
4ML-P medium maple on maple	RA rock of ages	BS bronze stria	2HC-W honey cherry on cherry
5ML-P cherry on maple	CF copper fusion	IO iridescent oxide slate	2ML-W natural maple on maple
6LC-P light cherry on cherry	CL chili		3ML-W light maple on maple
7MC-P medium cherry on cherry	CN cinnamon		4ML-W medium maple on maple
8DC-P dark cherry on cherry	EW-P eggshell		5ML-W cherry on maple
BB bethany beige	QS quilted stainless	88M-W mahogany on cherry	6LC-W light cherry on cherry
CM cardamom fiber	SB satin brush med. bronze	NB-W natural birch on birch	7MC-W medium cherry on cherry
SU sugar fiber		MB-W mocha birch	8DC-W dark cherry on cherry
WH wheat fiber		CB-W cherry on birch	9BC-W burgundy cherry on cherry
		6LC-W light cherry on birch	

45SCS4844-25M-TS-EW  
45SCS4844-25M-AS-EW  
45SCS4844-25M-BOTH-EW

series - unit identification (section) size - finish - options (molding) - stand-offs - finish  
when ordering Typical's - specify Typical "letter"-finish - finish - stand-off options

welcome  
4600/4500

model number	description	d	w	h	class	zone 1	list \$ zone 2
Typical "E"	laminated tops and laminate approach stand offs	77	106	44	125	20,956	22,633

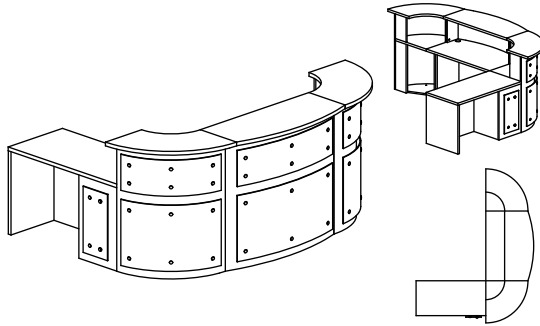

consists of:	d	w	h	quantity
45CCS4844 -AS curved center section	33	48	44	1
45CCR44 -AS 44" curved corner right	29	29	44	1
45CCL44 -AS 44" curved corner left hand	29	29	44	1
45RA48R -AS run off right hand	24	48	29	1

model number	description	d	w	h	class	list \$ zone 1	list \$ zone 2
Typical "F"	laminated tops and laminate approach stand offs	77	106	44	125	26,266	28,366

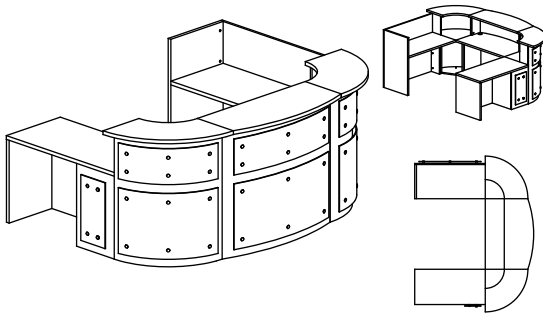

consists of:	d	w	h	quantity
45CCS4844 -AS curved center section	33	48	44	1
45CCR44 -AS 44" curved corner right	29	29	44	1
45CCL44 -AS 44" curved corner left hand	29	29	44	1
45RA48R -AS run off right hand	24	48	29	1
45RP48L -AS privacy panel run off left hand	24	48	43	1

<b>top material</b>	45 46	laminated top veneer top
<b>TS top stand-off options</b>		laminated veneer acrilux glass C.O.M.
<b>AS approach stand-off options</b>		laminated veneer acrilux glass C.O.M.

<b>avonite™</b>	top & approach stand-offs may be specified with avonite™ call for pricing
<b>glass stand-offs</b>	custom etching available with as a special with an additional upcharge standard color is silver -optional black available
<b>edge</b>	edge detail available for approach side only
<b>chemcast</b>	also available as stand-off. Call for pricing information

**SPL\*** special laminate may be ordered at a 5% upcharge, plus \$77.00 net freight fee- must provide manufacturer and item number

edge



welcome

4600 series  
4500 series

wood top, veneer chassis  
laminate top, veneer chassis

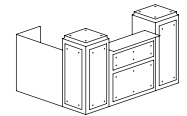

welcome  
4600/4500

model number	description	d	w	h	freight	list \$ zone 1	zone 2
Typical "G"	laminate tops	106	106	44	class 125	30,239	32,659

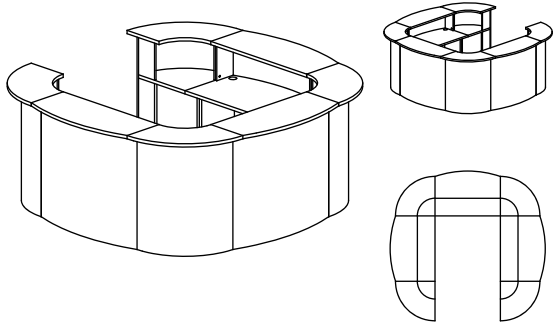

consists of:	d	w	h	quantity
45CCS4844 curved center section	33	48	44	3
45CCR44 44" curved corner right	29	29	44	2
45CCL44 44" curved corner left hand	29	29	44	2

model number	description	d	w	h	class	list \$ zone 1	list \$ zone 2
Typical "H"	laminate tops and laminate approach stand offs	77	106	44	class 125	25,042	29,335

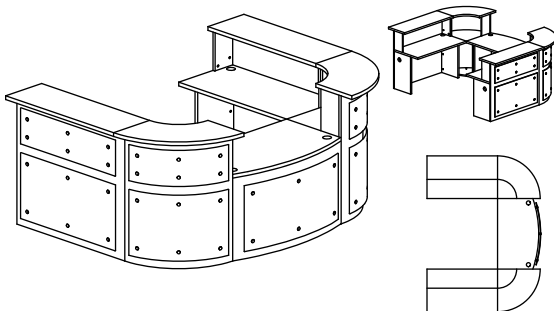

consists of:	d	w	h	quantity
45SCS4844 -AS square center section	29	48	44	2
45CCS4829 -AS curved center section	28	48	29	1
45CCR44 -AS 44" curved corner right	29	29	44	1
45CCL44 -AS 44" curved corner left hand	29	29	44	1

<b>laminates</b>	<b>NB-P</b> natural birch on birch <b>MB-P</b> mocha on birch <b>CB-P</b> cherry on birch <b>3L-P</b> saddle on walnut <b>4L-P</b> dark mahogany on walnut <b>25M-P</b> mahogany on walnut <b>25B-P</b> ebony on walnut <b>2ML-P</b> natural maple on maple <b>3ML-P</b> light maple on maple <b>4ML-P</b> medium maple on maple <b>5ML-P</b> cherry on maple <b>6LC-P</b> light cherry on cherry <b>7MC-P</b> medium cherry on cherry <b>8DC-P</b> dark cherry on cherry <b>BB</b> bethany beige <b>CM</b> cardamom fiber <b>SU</b> sugar fiber <b>WH</b> wheat fiber	<b>CU</b> curacao fiber <b>TY</b> thyme fiber <b>CO</b> coriander fiber <b>BA</b> black ashwood <b>GV</b> galvan <b>GS</b> graphite spektrum <b>NV-G</b> negotiating in geneva <b>OS</b> olive serenity <b>RA</b> rock of ages <b>CF</b> copper fusion <b>CL</b> chili <b>CN</b> cinnamon <b>EW-P</b> eggshell <b>QS</b> quilted stainless <b>BG</b> blackstar granite <b>SB</b> satin brush med. bronze	<b>BR</b> butterum granite <b>GT</b> graphite swirl <b>BF</b> black faux marble <b>LH</b> light hammer copper <b>CP</b> copper maple leaves <b>CE</b> celery fiber <b>AS</b> alumasteel <b>SPL</b> Designer palette* (\$179 list upcharge per stand-off) <b>MR</b> mercury stria <b>BS</b> bronze stria <b>IO</b> iridescent oxide slate	<b>7MC-W</b> medium cherry on birch <b>8DC-W</b> dark cherry on birch <b>3L-W</b> saddle on walnut <b>2KL-W</b> sepia on walnut <b>4L-W</b> dark mahogany on walnut <b>25M-W</b> mahogany on walnut <b>25B-W</b> ebony on walnut <b>25C-W</b> cherry on walnut <b>1NC-W</b> natural cherry on cherry <b>2HC-W</b> honey cherry on cherry <b>2ML-W</b> natural maple on maple <b>3ML-W</b> light maple on maple <b>4ML-W</b> medium maple on maple <b>5ML-W</b> cherry on maple <b>6LC-W</b> light cherry on cherry <b>7MC-W</b> medium cherry on cherry <b>8DC-W</b> dark cherry on cherry <b>9BC-W</b> burgundy cherry on cherry
------------------	---	---	---	--

45SCS4844-25M-TS-EW  
45SCS4844-25M-AS-EW  
45SCS4844-25M-BOTH-EW

series - unit identification (section) size - finish - options (molding) - stand-offs - finish  
when ordering Typical's - specify Typical "letter"-finish - finish - stand-off options

welcome  
4600/4500

model number	description	d	w	h	freight	list \$ zone 1	list \$ zone 2
Typical "I"	laminated tops no stand offs	81	106	44	class 125	12,183	13,159

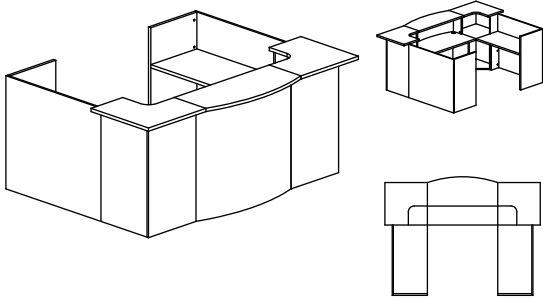

consists of:	d	w	h	quantity
45CCS4844 curved center section	33	48	44	1
45SCR44 44" square corner right hand	29	29	44	1
45SCL44 44" square corner left hand	29	29	44	1
45RP48R privacy panel run off right hand	24	48	43	1
45RP48L privacy panel run off left hand	24	48	43	1

model number	description	d	w	h	freight	list \$ zone 1	list \$ zone 2
Typical "J"	laminated tops and both top and approach stand offs in laminate	72	96	55.375	class 125	14,087	16,361

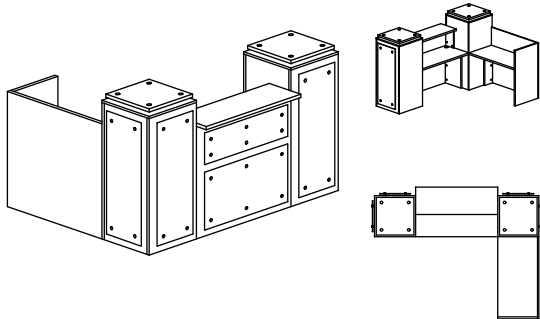

consists of:	d	w	h	quantity
45STR53 -BOTH 53" square tower right hand	24	24	53	1
45STL53 -BOTH 53" square tower left hand	24	24	53	1
45RP48R privacy panel run off right hand	24	48	43	1
45SCS4844 -AS square center section	29	48	44	1

top material	45 46	laminated top veneer top
TS top stand-off options		laminated veneer acrilux glass C.O.M.
AS approach stand-off options		laminated veneer acrilux glass C.O.M.

avonite™	top & approach stand-offs may be specified with avonite™ call for pricing
glass stand-offs	custom etching available with as a special with an additional upcharge standard color is silver -optional black available
edge	edge detail available for approach side only
chemcast	also available as stand-off. Call for pricing information

**SPL\*** special laminate may be ordered at a 5% upcharge, plus \$77.00 net freight fee- must provide manufacturer and item number

edge



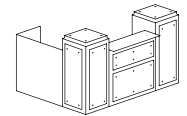

model number	description	d	w	h	freight	list \$ zone 1	list \$ zone 2
Typical "K"	laminate tops no stand offs	77	106	44	class 125	13,415	14,486

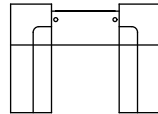
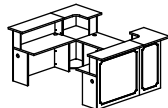
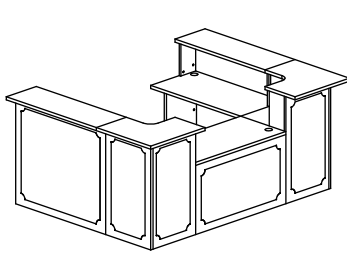

consists of:

description	d	w	h	quantity
45SCS4829-M square center section with molding	24	48	29	1
45SCS4844-M square center section with molding	29	48	44	2
45SCR44-M 44" square corner right hand with molding	29	29	44	1
45SCL44-M 44" square corner left hand with molding	29	29	44	1

model number	description	d	w	h	freight	list \$ zone 1	list \$ zone 2
Typical "L"	laminate tops and laminate top stand offs approach with molding	72	96	55.375	class 125	13,585	14,670

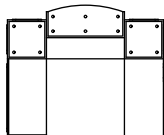
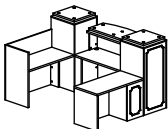
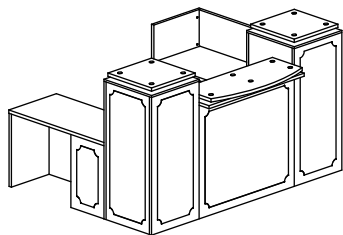

description	d	w	h	quantity
45STR53-M -TS 53" square tower right hand with molding	24	24	53	1
45STL53-M -TS 53" square tower left hand with molding	24	24	53	1
45RP48L-M privacy panel run off left hand with molding	24	48	43	1
45SCS4844-M -TS square center section with molding	29	48	44	1
45RA48R-M run off right hand with molding	24	48	29	1

<b>laminates</b>	<b>NB-P</b> natural birch on birch <b>MB-P</b> mocha on birch <b>CB-P</b> cherry on birch <b>3L-P</b> saddle on walnut <b>4L-P</b> dark mahogany on walnut <b>25M-P</b> mahogany on walnut <b>25B-P</b> ebony on walnut <b>2ML-P</b> natural maple on maple <b>3ML-P</b> light maple on maple <b>4ML-P</b> medium maple on maple <b>5ML-P</b> cherry on maple <b>6LC-P</b> light cherry on cherry <b>7MC-P</b> medium cherry on cherry <b>8DC-P</b> dark cherry on cherry <b>BB</b> bethany beige <b>CM</b> cardamom fiber <b>SU</b> sugar fiber <b>WH</b> wheat fiber	<b>CU</b> curacao fiber <b>TY</b> thyme fiber <b>CO</b> coriander fiber <b>BA</b> black ashwood <b>GV</b> galvan <b>GS</b> graphite specktrum <b>NV-G</b> negotiating in geneva <b>OS</b> olive serenity <b>RA</b> rock of ages <b>CF</b> copper fusion <b>CL</b> chili <b>CN</b> cinnamon <b>EW-P</b> eggshell <b>QS</b> quilted stainless <b>BG</b> blackstar granite <b>SB</b> satin brush med. bronze	<b>BR</b> butterum granite <b>GT</b> graphite swirl <b>BF</b> black faux marble <b>LH</b> light hammer copper <b>CP</b> copper maple leaves <b>CE</b> celery fiber <b>AS</b> alumasteel <b>SPL</b> Designer palette* (\$179 list upcharge per stand-off) <b>MR</b> mercury stria <b>BS</b> bronze stria <b>IO</b> iridescent oxide slate	<b>7MC-W</b> medium cherry on birch <b>8DC-W</b> dark cherry on birch <b>3L-W</b> saddle on walnut <b>2KL-W</b> sepia on walnut <b>4L-W</b> dark mahogany on walnut <b>25M-W</b> mahogany on walnut <b>25B-W</b> ebony on walnut <b>25C-W</b> cherry on walnut <b>1NC-W</b> natural cherry on cherry <b>2HC-W</b> honey cherry on cherry <b>2ML-W</b> natural maple on maple <b>3ML-W</b> light maple on maple <b>4ML-W</b> medium maple on maple <b>5ML-W</b> cherry on maple <b>6LC-W</b> light cherry on cherry <b>7MC-W</b> medium cherry on cherry <b>8DC-W</b> dark cherry on cherry <b>9BC-W</b> burgundy cherry on cherry
------------------	---	--	---	--

45SCS4844-25M-TS-EW  
45SCS4844-25M-AS-EW  
45SCS4844-25M-BOTH-EW

series - unit identification (section) size - finish - options (molding) - stand-offs - finish  
when ordering Typical's - specify Typical "letter"-finish - finish - stand-off options

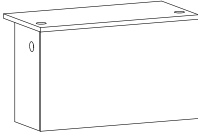
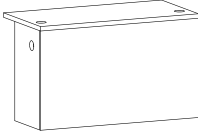
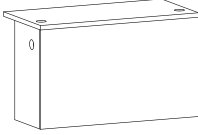
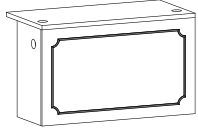
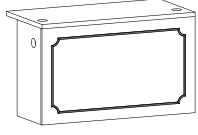
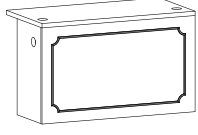
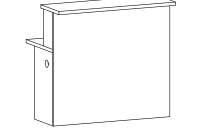
	model number	description	d	w	h	freight	base unit	
							zone 1	zone 2
	46SCS4829 - _ _ - _	square center section	24	48	29	class 125	3,066	3,311
	45SCS4829 - _ _ - _						1,989	2,148
	46SCS6029 - _ _ - _	square center section	24	60	29	class 125	3,835	4,141
	45SCS6029 - _ _ - _						2,488	2,687
	46SCS7229 - _ _ - _	square center section	24	72	29	class 125	4,598	4,969
	45SCS7229 - _ _ - _						2,987	3,225
	46SCS4829-M - _ -	square center section with molding	24	48	29	class 125	3,209	3,466
	45SCS4829-M - _ -						2,138	2,307
	46SCS6029-M - _ -	square center section with molding	24	60	29	class 125	4,015	4,333
	45SCS6029-M - _ -						2,668	2,880
	46SCS7229-M - _ -	square center section with molding	24	72	29	class 125	4,816	5,203
	45SCS7229-M - _ -						3,204	3,464
	46SCS4844 - _ _ - _	square center section	29	48	44	class 125	4,646	5,017
	45SCS4844 - _ _ - _						3,166	3,421

**top material** 45 laminate top  
46 veneer top

**TS top stand-off options**

**AS approach stand-off options**

**edge**

**avonite™** top & approach stand-offs may be specified with avonite™ call for pricing

**glass** custom etching available with as a special with an additional upcharge  
**stand-offs** standard color is silver -optional black available  
**edge** edge detail available for approach side only  
**chemcast** also available as stand-off. Call for pricing information

**SPL\*** special laminate may be ordered at a 5% upcharge, plus \$77.00 net freight fee- must provide manufacturer and item number

If top (not standoff) is a different color than chassis (not standoff) indicate that on order (no upcharge)



welcome

4600 series  
4500 series

wood top, veneer chassis  
laminate top, veneer chassis

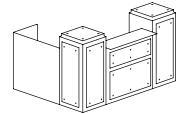

welcome  
4600/4500

laminate stand-off						veneer stand-off						acrilux stand-off						glass stand-off					
TS		AS		BOTH		TS		AS		BOTH		TS		AS		BOTH		TS		AS		BOTH	
zone 1	zone 2	zone 1	zone 2	zone 1	zone 2	zone 1	zone 2	zone 1	zone 2	zone 1	zone 2	zone 1	zone 2	zone 1	zone 2	zone 1	zone 2	zone 1	zone 2	zone 1	zone 2	zone 1	zone 2
4,159	4,491	4,492	4,852	5,586	6,031	4,816	5,201	4,779	5,161	6,068	6,554	4,906	5,299	4,869	5,258	6,249	6,747	7,378	7,967	6,348	6,857	10,661	11,514
3,081	3,327	3,416	3,689	4,508	4,869	3,739	4,038	3,703	3,998	5,453	5,888	3,829	4,136	3,792	4,095	5,632	6,083	6,302	6,805	5,272	5,695	9,584	10,351
5,692	6,147	6,116	6,605	7,474	8,071	6,020	6,501	5,999	6,478	7,590	8,197	6,136	6,628	6,116	6,605	7,823	8,163	9,224	9,962	7,940	8,575	13,329	14,395
3,845	4,153	4,270	4,611	5,627	6,077	4,673	5,046	4,651	5,022	6,837	7,383	4,790	5,172	4,769	5,150	7,071	7,633	7,876	8,507	6,593	7,118	11,982	12,942
6,222	6,719	6,741	7,281	8,364	9,034	7,224	7,802	7,166	7,739	9,101	9,830	7,362	7,951	7,303	7,888	10,067	10,872	11,064	11,949	9,521	10,283	15,992	17,271
4,609	4,979	5,129	5,540	6,752	7,292	5,612	6,061	5,792	6,256	8,178	8,833	5,750	6,210	5,909	6,382	8,433	9,108	9,451	10,208	7,908	8,540	14,379	15,530
4,301	4,645	-	-	-	-	4,959	5,356	-	-	-	-	5,049	5,454	-	-	-	-	7,521	8,122	-	-	-	-
3,230	3,489	-	-	-	-	3,884	4,195	-	-	-	-	3,973	4,291	-	-	-	-	6,444	6,959	-	-	-	-
5,373	5,803	-	-	-	-	6,206	6,702	-	-	-	-	6,322	6,828	-	-	-	-	9,404	10,156	-	-	-	-
4,026	4,348	-	-	-	-	4,853	5,242	-	-	-	-	4,969	5,367	-	-	-	-	7,876	8,507	-	-	-	-
6,439	6,954	-	-	-	-	7,442	8,037	-	-	-	-	7,580	8,187	-	-	-	-	11,281	12,184	-	-	-	-
4,827	5,213	-	-	-	-	5,829	6,295	-	-	-	-	5,967	6,444	-	-	-	-	9,670	10,443	-	-	-	-
5,739	6,199	7,171	7,745	8,264	8,925	6,396	6,907	7,611	8,220	9,362	10,110	6,487	7,005	7,701	8,318	9,542	10,306	8,959	9,676	10,857	11,726	15,169	16,383
4,260	4,599	4,631	6,147	6,784	7,327	4,916	5,310	6,131	6,622	8,513	9,194	5,007	5,408	6,222	6,719	8,062	8,707	7,479	8,077	9,378	10,128	13,689	14,784

<b>laminates</b>	<b>NB-P</b> natural birch on birch <b>MB-P</b> mocha on birch <b>CB-P</b> cherry on birch <b>3L-P</b> saddle on walnut <b>4L-P</b> dark mahogany on walnut <b>25M-P</b> mahogany on walnut <b>25B-P</b> ebony on walnut <b>2ML-P</b> natural maple on maple <b>3ML-P</b> light maple on maple <b>4ML-P</b> medium maple on maple <b>5ML-P</b> cherry on maple <b>6LC-P</b> light cherry on cherry <b>7MC-P</b> medium cherry on cherry <b>8DC-P</b> dark cherry on cherry <b>BB</b> bethany beige <b>CM</b> cardamom fiber <b>SU</b> sugar fiber <b>WH</b> wheat fiber	<b>CU</b> curacao fiber <b>TY</b> thyme fiber <b>CO</b> coriander fiber <b>BA</b> black ashwood <b>GV</b> galvan <b>GS</b> graphite spektrum <b>NV</b> negotiating in geneva <b>NV-G</b> negotiating in geneva gloss <b>OS</b> olive serenity <b>RA</b> rock of ages <b>CF</b> copper fusion <b>CL</b> chili <b>CN</b> cinnamon <b>EW-P</b> eggshell <b>QS</b> quilted stainless <b>BG</b> blackstar granite <b>SB</b> satin brush med. bronze	<b>BR</b> butterum granite <b>GT</b> graphite swirl <b>BF</b> black faux marble <b>LH</b> light hammer copper <b>CP</b> copper maple leaves <b>CE</b> celery fiber <b>AS</b> alumasteel <b>SPL</b> <b>Designer palette*</b> (\$179 list upcharge per stand-off) <b>MR</b> mercury stria <b>BS</b> bronze stria <b>IO</b> iridescent oxide slate	<b>88M-W</b> mahogany on cherry <b>NB-W</b> natural birch on birch <b>MB-W</b> mocha birch <b>CB-W</b> cherry on birch <b>6LC-W</b> light cherry on birch	<b>7MC-W</b> medium cherry on birch <b>8DC-W</b> dark cherry on birch <b>3L-W</b> saddle on walnut <b>2KL-W</b> sepia on walnut <b>4L-W</b> dark mahogany on walnut <b>25M-W</b> mahogany on walnut <b>25B-W</b> ebony on walnut <b>25C-W</b> cherry on walnut <b>1NC-W</b> natural cherry on cherry <b>2HC-W</b> honey cherry on cherry <b>2ML-W</b> natural maple on maple <b>3ML-W</b> light maple on maple <b>4ML-W</b> medium maple on maple <b>5ML-W</b> cherry on maple <b>6LC-W</b> light cherry on cherry <b>7MC-W</b> medium cherry on cherry <b>8DC-W</b> dark cherry on cherry <b>9BC-W</b> burgundy cherry on cherry
------------------	---	--	--	---	--



45SCS4844-25M-TS-EW  
45SCS4844-25M-AS-EW  
45SCS4844-25M-BOTH-EW

series - unit identification (section) size - finish - options (molding) - stand-offs - finish  
when ordering Typical's - specify Typical "letter"-finish - finish - stand-off options

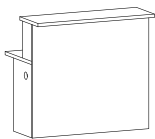
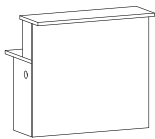
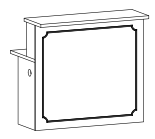
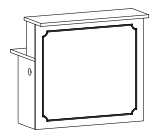
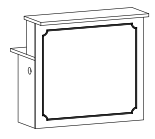
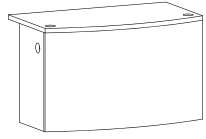
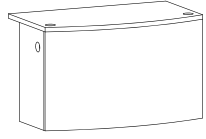
						base unit					
model number						zone 1	zone 2				
						d	w	h	freight		
	46SCS6044 - _ _ - _	square center section	29	60	44	class 125	5,808	6,275			
	45SCS6044 - _ _ - _						3,951	4,280			
	46SCS7244 - _ _ - _	square center section	29	72	44	class 125	6,970	7,527			
	45SCS7244 - _ _ - _						4,752	5,135			
	46SCS4844-M - _ -	square center section with molding	29	48	44	class 125	4,800	5,184			
	45SCS4844-M - _ -						3,315	3,580			
	46SCS6044-M - _ -	square center section with molding	29	60	44	class 125	5,988	6,468			
	45SCS6044-M - _ -						3,962	4,279			
	46SCS7244-M - _ -	square center section with molding	29	72	44	class 125	7,187	7,762			
	45SCS7244-M - _ -						4,969	5,367			
	46CCS4829 - _ _ - _	curved center section	28	48	29	class 125	3,113	3,363			
	45CCS4829 - _ _ - _						3,023	3,265			
	46CCS6029 - _ _ - _	curved center section	28	60	29	class 125	3,893	4,205			
	45CCS6029 - _ _ - _						3,782	4,084			

top material

45 laminate top  
46 veneer top

TS top stand-off options

laminate veneer  
acrilux glass  
C.O.M.

AS approach stand-off options

laminate veneer  
acrilux glass  
C.O.M.

edge



avonite™

top & approach stand-offs may be specified with avonite™ call for pricing

SPL\*

special laminate may be ordered at a 5% upcharge, plus \$77.00 net freight fee- must provide manufacturer and item number

glass

custom etching available with as a special with an additional upcharge

stand-offs

standard color is silver -optional black available

edge

edge detail available for approach side only

chemcast

also available as stand-off. Call for pricing information

If top (not standoff) is a different color than chassis (not standoff) indicate that on order (no upcharge)

welcome

4600 series  
4500 series

wood top, veneer chassis  
laminate top, veneer chassis

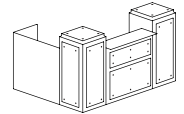



welcome  
4600/4500

laminate stand-off						veneer stand-off						acrilux stand-off						glass stand-off					
TS		AS		BOTH		TS		AS		BOTH		TS		AS		BOTH		TS		AS		BOTH	
zone 1	zone 2	zone 1	zone 2	zone 1	zone 2	zone 1	zone 2	zone 1	zone 2	zone 1	zone 2	zone 1	zone 2	zone 1	zone 2	zone 1	zone 2	zone 1	zone 2	zone 1	zone 2	zone 1	zone 2
7,177	7,750	8,964	9,681	10,321	11,147	7,993	8,633	9,516	10,278	11,700	12,636	8,110	8,759	9,632	10,402	11,934	12,889	11,197	12,092	13,568	14,653	18,962	20,479
6,381	6,891	7,118	7,688	8,476	9,153	7,208	7,786	7,664	8,277	9,937	10,734	6,758	7,298	7,781	8,404	9,780	10,562	9,351	10,099	11,727	12,718	17,116	18,485
8,592	9,280	10,757	11,617	12,380	13,370	9,595	10,363	11,420	12,333	14,039	15,163	9,733	10,511	11,558	12,483	14,316	15,461	13,435	14,510	16,283	17,586	22,754	24,575
6,375	6,886	8,539	9,223	10,162	10,975	7,378	7,967	9,197	9,934	11,823	12,768	7,515	8,117	9,314	10,058	12,077	13,044	11,218	12,116	14,066	15,192	20,537	22,180
5,893	6,364	-	-	-	-	6,550	7,075	-	-	-	-	6,640	7,172	-	-	-	-	9,113	9,841	-	-	-	-
4,408	4,761	-	-	-	-	5,065	5,470	-	-	-	-	5,155	5,568	-	-	-	-	7,628	8,238	-	-	-	-
7,166	7,739	-	-	-	-	8,173	8,827	-	-	-	-	8,291	8,954	-	-	-	-	11,377	12,287	-	-	-	-
5,320	5,746	-	-	-	-	6,148	6,639	-	-	-	-	6,938	7,493	-	-	-	-	9,351	10,099	-	-	-	-
8,810	95,144	-	-	-	-	9,812	10,598	-	-	-	-	9,950	10,746	-	-	-	-	13,435	14,510	-	-	-	-
6,375	6,886	-	-	-	-	7,378	7,967	-	-	-	-	7,515	8,117	-	-	-	-	11,218	12,116	-	-	-	-
4,206	4,542	4,540	4,903	5,632	6,083	6,047	6,530	4,827	5,213	7,760	8,380	6,136	6,628	4,631	5,310	7,940	8,575	7,489	8,089	-	-	-	-
4,116	4,445	4,450	4,806	5,543	5,986	4,774	5,155	4,737	5,115	6,487	7,005	4,863	5,253	4,827	5,213	6,667	7,201	7,399	7,991	-	-	-	-
5,251	5,671	5,675	6,129	7,033	7,595	7,558	8,163	6,036	6,519	9,701	10,477	7,674	8,290	6,153	6,645	9,935	10,729	9,362	10,110	-	-	-	-
5,140	5,551	5,564	6,010	6,922	7,476	5,967	6,444	5,919	6,392	8,110	8,759	6,078	6,565	6,030	6,514	8,344	9,011	9,250	9,991	-	-	-	-

<b>laminat</b>	<b>NB-P</b> natural birch on birch	<b>CU</b> curacao fiber	<b>BR</b> butterum granite	<b>7MC-W</b> medium cherry on birch
<b>MB-P</b> mocha on birch	<b>TY</b> thyme fiber	<b>GT</b> graphite swirl	<b>BT</b> black faux marble	<b>8DC-W</b> dark cherry on birch
<b>CB-P</b> cherry on birch	<b>CO</b> coriander fiber	<b>BF</b> black faux marble	<b>LH</b> light hammer copper	<b>3L-W</b> saddle on walnut
<b>3L-P</b> saddle on walnut	<b>BA</b> black ashwood	<b>CP</b> copper maple leaves	<b>CE</b> celery fiber	<b>2KL-W</b> sepia on walnut
<b>4L-P</b> dark mahogany on walnut	<b>GS</b> galvan	<b>AS</b> alumasteel	<b>SPL</b> Designer palette* (\$179 list upcharge per stand-off)	<b>4L-W</b> dark mahogany on walnut
<b>25M-P</b> mahogany on walnut	<b>NV</b> negotiating in geneva	<b>MR</b> mercury stria	<b>MR</b> mercury stria	<b>25M-W</b> mahogany on walnut
<b>25B-P</b> ebony on walnut	<b>NV-G</b> negotiating in geneva gloss	<b>BS</b> bronze stria	<b>BS</b> bronze stria	<b>25B-W</b> ebony on walnut
<b>2ML-P</b> natural maple on maple	<b>OS</b> olive serenity	<b>IO</b> iridescent oxide slate	<b>IO</b> iridescent oxide slate	<b>25C-W</b> cherry on walnut
<b>3ML-P</b> light maple on maple	<b>RA</b> rock of ages			<b>1NC-W</b> natural cherry on cherry
<b>4ML-P</b> medium maple on maple	<b>CF</b> copper fusion			<b>2HC-W</b> honey cherry on cherry
<b>5ML-P</b> cherry on maple	<b>CL</b> chili			<b>2ML-W</b> natural maple on maple
<b>6LC-P</b> light cherry on cherry	<b>CN</b> cinnamon			<b>3ML-W</b> light maple on maple
<b>7MC-P</b> medium cherry on cherry	<b>EW-P</b> eggshell			<b>4ML-W</b> medium maple on maple
<b>8DC-P</b> dark cherry on cherry	<b>QS</b> quilted stainless	<b>veneer</b>		<b>5ML-W</b> cherry on maple
<b>BB</b> bethany beige	<b>BG</b> blackstar granite			<b>6LC-W</b> light cherry on cherry
<b>CM</b> cardamom fiber	<b>SB</b> satin brush med. bronze			<b>7MC-W</b> medium cherry on cherry
<b>SU</b> sugar fiber				<b>8DC-W</b> dark cherry on cherry
<b>WH</b> wheat fiber				<b>9BC-W</b> burgundy cherry on cherry

45SCS4844-25M-TS-EW  
45SCS4844-25M-AS-EW  
45SCS4844-25M-BOTH-EW

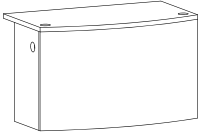
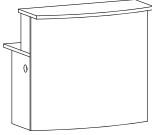
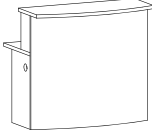
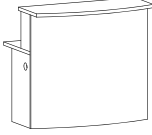
series - unit identification (section) size - finish - options (molding) - stand-offs - finish  
when ordering Typical's - specify Typical "letter"-finish - finish - stand-off options

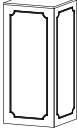
						base unit					
model number						zone 1	zone 2				
						d	w	h	freight		
	46CCS7229 - _ _ - _	curved center section	28	72	29	class 125	4,673	5,046			
	45CCS7229 - _ _ - _						4,535	4,898			
	46CCS4844 - _ _ - _	curved center section	33	48	44	class 125	4,726	5,103			
	45CCS4844 - _ _ - _						4,429	4,783			
	46CCS6044 - _ _ - _	curved center section	33	60	44	class 125	5,909	6,382			
	45CCS6044 - _ _ - _						5,538	5,981			
	46CCS7244 - _ _ - _	curved center section	33	72	44	class 125	7,091	7,659			
	46CCS7244 - _ _ - _						6,646	7,178			
	46STR53 - _ _ - _	53" square tower right hand	24	24	53	class 125	1,608	1,735			
	45STR53 - _ _ - _						1,608	1,735			
	46STL53 - _ _ - _	53" square tower left hand	24	24	53	class 125	1,608	1,735			
	45STL53 - _ _ - _						1,608	1,735			
	46STR53-M - _ -	53" square tower right hand with molding	24	24	53	class 125	1,755	1,895			
	45STR53-M - _ -						1,755	1,895			

**top material** 45 laminate top  
46 veneer top

**TS top stand-off options**

**AS approach stand-off options**

**edge**

**avonite™** top & approach stand-offs may be specified with avonite™ call for pricing

**glass stand-offs** custom etching available with as a special with an additional upcharge standard color is silver -optional black available  
**edge** edge detail available for approach side only  
**chemcast** also available as stand-off. Call for pricing information

**SPL\*** special laminate may be ordered at a 5% upcharge, plus \$77.00 net freight fee- must provide manufacturer and item number

If top (not standoff) is a different color than chassis (not standoff) indicate that on order (no upcharge)



welcome

4600 series  
4500 series

wood top, veneer chassis  
laminate top, veneer chassis

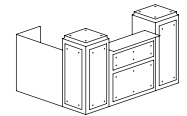

welcome  
4600/4500

laminate stand-off						veneer stand-off						acrilux stand-off						glass stand-off					
TS		AS		BOTH		TS		AS		BOTH		TS		AS		BOTH		TS		AS		BOTH	
zone 1	zone 2	zone 1	zone 2	zone 1	zone 2	zone 1	zone 2	zone 1	zone 2	zone 1	zone 2	zone 1	zone 2	zone 1	zone 2	zone 1	zone 2	zone 1	zone 2	zone 1	zone 2	zone 1	zone 2
6,295	6,799	6,816	7,361	8,438	9,114	9,075	9,801	7,240	7,819	11,642	12,574	9,213	9,950	7,378	7,967	1,193	12,871	11,234	12,132	-	-	-	-
6,158	6,650	6,678	7,212	8,301	8,965	7,160	7,734	7,102	7,670	9,728	10,506	7,293	7,876	7,240	7,819	10,003	10,803	11,096	11,984	-	-	-	-
5,818	6,284	7,250	7,831	8,344	9,011	7,659	8,272	7,691	8,306	10,624	11,474	7,749	8,369	7,781	8,404	10,804	11,669	9,101	9,830	-	-	-	-
5,521	5,963	6,953	7,509	8,046	8,690	6,179	6,674	7,394	7,986	9,144	9,876	6,269	6,771	7,484	8,082	9,325	10,070	8,805	9,509	-	-	-	-
7,266	7,848	9,065	9,790	10,422	11,256	9,574	10,340	9,617	10,386	13,281	14,344	9,690	10,466	9,733	10,511	13,515	14,595	11,377	12,287	-	-	-	-
6,895	7,447	8,693	9,389	10,051	10,855	7,722	8,340	9,239	9,979	11,430	12,344	7,834	8,461	9,351	10,099	11,664	12,597	11,006	11,886	-	-	-	-
8,715	9,410	10,878	11,748	12,501	13,502	11,488	12,407	11,536	12,459	15,933	17,208	12,554	13,559	11,674	12,607	16,209	17,505	13,653	14,745	-	-	-	-
8,269	8,931	10,433	11,268	12,056	13,020	9,272	10,013	11,090	11,978	13,716	14,813	9,404	10,156	11,223	12,121	13,992	15,111	13,207	14,264	-	-	-	-
2,456	2,652	3,033	3,277	3,882	4,193	3,055	3,299	3,633	3,924	5,082	5,488	3,146	3,397	3,867	4,176	5,405	5,837	3,554	3,838	5,983	6,462	7,929	8,564
2,456	2,652	3,033	3,277	3,882	4,193	3,055	3,299	3,633	3,924	5,082	5,488	3,146	3,397	3,867	4,176	5,405	5,837	3,554	3,838	5,983	6,462	7,929	8,564
2,456	2,652	3,033	3,277	3,882	4,193	3,055	3,299	3,633	3,924	5,082	5,488	3,146	3,397	3,867	4,176	5,405	5,837	3,554	3,838	5,983	6,462	7,929	8,564
2,456	2,652	3,033	3,277	3,882	4,193	3,055	3,299	3,633	3,924	5,082	5,488	3,146	3,397	3,867	4,176	5,405	5,837	3,554	3,838	5,983	6,462	7,929	8,564
2,615	2,823	-	-	-	-	3,204	3,460	-	-	-	-	3,867	4,176	-	-	-	-	3,703	3,998	-	-	-	-
2,615	2,823	-	-	-	-	3,204	3,460	-	-	-	-	3,867	4,176	-	-	-	-	3,703	3,998	-	-	-	-

<b>laminate</b>	<b>NB-P</b> natural birch on birch <b>MB-P</b> mocha on birch <b>CB-P</b> cherry on birch <b>3L-P</b> saddle on walnut <b>4L-P</b> dark mahogany on walnut <b>25M-P</b> mahogany on walnut <b>25B-P</b> ebony on walnut <b>2ML-P</b> natural maple on maple <b>3ML-P</b> light maple on maple <b>4ML-P</b> medium maple on maple <b>5ML-P</b> cherry on maple <b>6LC-P</b> light cherry on cherry <b>7MC-P</b> medium cherry on cherry <b>8DC-P</b> dark cherry on cherry <b>BB</b> bethany beige <b>CM</b> cardamom fiber <b>SU</b> sugar fiber <b>WH</b> wheat fiber	<b>CU</b> curacao fiber <b>TY</b> thyme fiber <b>CO</b> coriander fiber <b>BA</b> black ashwood <b>GV</b> galvan <b>GS</b> graphite specktrum <b>NV</b> negotiating in geneva <b>NV-G</b> negotiating in geneva gloss <b>OS</b> olive serenity <b>RA</b> rock of ages <b>CF</b> copper fusion <b>CL</b> chili <b>CN</b> cinnamon <b>EW-P</b> eggshell <b>QS</b> quilted stainless <b>BG</b> blackstar granite <b>SB</b> satin brush med. bronze	<b>BR</b> butterum granite <b>GT</b> graphite swirl <b>BF</b> black faux marble <b>LH</b> light hammer copper <b>CP</b> copper maple leaves <b>CE</b> celery fiber <b>AS</b> alumasteel <b>SPL</b> <b>Designer palette*</b> (\$179 list upcharge per stand-off) <b>MR</b> mercury stria <b>BS</b> bronze stria <b>IO</b> iridescent oxide slate	<b>7MC-W</b> medium cherry on birch <b>8DC-W</b> dark cherry on birch <b>3L-W</b> saddle on walnut <b>2KL-W</b> sepia on walnut <b>4L-W</b> dark mahogany on walnut <b>25M-W</b> mahogany on walnut <b>25B-W</b> ebony on walnut <b>25C-W</b> cherry on walnut <b>1NC-W</b> natural cherry on cherry <b>2HC-W</b> honey cherry on cherry <b>2ML-W</b> natural maple on maple <b>3ML-W</b> light maple on maple <b>4ML-W</b> medium maple on maple <b>5ML-W</b> light cherry on maple <b>6LC-W</b> light cherry on cherry <b>7MC-W</b> medium cherry on cherry <b>8DC-W</b> dark cherry on cherry <b>9BC-W</b> burgundy cherry on cherry
-----------------	---	---	--	--

45SCS4844-25M-TS-EW  
45SCS4844-25M-AS-EW  
45SCS4844-25M-BOTH-EW

series - unit identification (section) size - finish - options (molding) - stand-offs - finish  
when ordering Typical's - specify Typical "letter"-finish - finish - stand-off options

welcome  
4600/4500

	model number	description	d	w	h	freight	base unit	
							zone 1	zone 2
	46STL53-M - _ -	53" square tower left hand with molding	24	24	53	class 125	1,755	1,895
	45STL53-M - _ -						1,755	1,895
	46CTR53 - _ - _ -	53" curved tower right hand	29	29	53	class 125	4,116	4,445
	45CTR53 - _ - _ -						4,116	4,445
	46CRL53 - _ - _ -	53" curved tower left hand	29	29	53	class 125	4,116	4,445
	45CTL53 - _ - _ -						4,116	4,445
	46SCR44 - _ - _ -	44" square corner right hand	29	29	44	class 125	2,785	3,007
	45SCR44 - _ - _ -						2,185	2,360
	46SCL44 - _ - _ -	44" square corner left hand	29	29	44	class 125	2,785	3,007
	45SCL44 - _ - _ -						2,185	2,360
	46SCR44-M - _ -	44" square corner right hand with molding	29	29	44	class 125	2,922	3,156
	45SCR44-M - _ -						2,324	2,509
	46SCL44-M - _ -	44" square corner left hand with molding	29	29	44	class 125	2,922	3,156
	45SCL44-M - _ -						2,324	2,509

**top material** 45 laminate top  
46 veneer top

**TS top stand-off options**

**AS approach stand-off options**

**edge**

**avonite™** top & approach stand-offs may be specified with avonite™ call for pricing

**glass stand-offs** custom etching available with as a special with an additional upcharge standard color is silver -optional black available  
**edge** edge detail available for approach side only  
**chemcast** also available as stand-off. Call for pricing information

**SPL\*** special laminate may be ordered at a 5% upcharge, plus \$77.00 net freight fee- must provide manufacturer and item number

If top (not standoff) is a different color than chassis (not standoff) indicate that on order (no upcharge)



welcome

4600 series  
4500 series

wood top, veneer chassis  
laminate top, veneer chassis

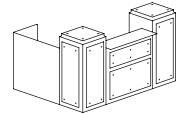

welcome  
4600/4500

laminate stand-off						veneer stand-off						acrilux stand-off						glass stand-off					
TS		AS		BOTH		TS		AS		BOTH		TS		AS		BOTH		TS		AS		BOTH	
zone 1	zone 2	zone 1	zone 2	zone 1	zone 2	zone 1	zone 2	zone 1	zone 2	zone 1	zone 2	zone 1	zone 2	zone 1	zone 2	zone 1	zone 2	zone 1	zone 2	zone 1	zone 2	zone 1	zone 2
2,615	2,823	-	-	-	-	3,204	3,460	-	-	-	-	3,867	4,176	-	-	-	-	3,703	3,998	-	-	-	-
2,615	2,823	-	-	-	-	3,204	3,460	-	-	-	-	3,867	4,176	-	-	-	-	3,703	3,998	-	-	-	-
5,140	5,551	6,640	7,172	7,664	8,277	6,879	7,430	7,081	7,647	9,844	10,631	6,996	7,556	7,197	7,773	10,078	10,883	8,036	8,678	-	-	-	-
5,140	5,551	6,640	7,172	7,664	8,277	6,879	7,430	7,081	7,647	9,844	10,631	6,996	7,556	7,197	7,773	10,078	10,883	8,036	8,678	-	-	-	-
5,140	5,551	6,640	7,172	7,664	8,277	6,879	7,430	7,081	7,647	9,844	10,631	6,996	7,556	7,197	7,773	10,078	10,883	8,036	8,678	-	-	-	-
5,140	5,551	6,640	7,172	7,664	8,277	6,879	7,430	7,081	7,647	9,844	10,631	6,996	7,556	7,197	7,773	10,078	10,883	8,036	8,678	-	-	-	-
3,633	3,924	4,212	4,549	5,060	5,465	4,233	4,571	4,047	4,371	5,495	5,934	4,323	4,669	4,238	4,578	5,781	6,243	4,731	5,110	7,160	7,734	9,107	9,836
3,033	3,277	3,612	3,900	4,460	4,817	3,633	3,924	3,448	3,723	4,896	5,287	3,723	4,022	3,920	4,234	5,182	5,597	4,132	4,463	6,561	7,086	8,508	9,188
3,633	3,924	4,212	4,549	5,060	5,465	4,233	4,571	4,047	4,371	5,495	5,934	4,323	4,669	4,238	4,578	5,781	6,243	4,731	5,110	7,160	7,734	9,107	9,836
3,033	3,277	3,612	3,900	4,460	4,817	3,633	3,924	3,448	3,723	4,896	5,287	3,723	4,022	3,920	4,234	5,182	5,597	4,132	4,463	6,561	7,086	8,508	9,188
3,771	4,073	-	-	-	-	4,371	4,721	-	-	-	-	4,460	4,817	-	-	-	-	4,869	5,258	-	-	-	-
3,172	3,425	-	-	-	-	3,766	4,067	-	-	-	-	3,862	4,170	-	-	-	-	4,270	4,611	-	-	-	-
3,771	4,073	-	-	-	-	4,371	4,721	-	-	-	-	4,460	4,817	-	-	-	-	4,869	5,258	-	-	-	-
3,172	3,425	-	-	-	-	3,766	4,067	-	-	-	-	3,862	4,170	-	-	-	-	4,270	4,611	-	-	-	-

<b>laminate</b>	<b>NB-P</b> natural birch on birch <b>MB-P</b> mocha on birch <b>CB-P</b> cherry on birch <b>3L-P</b> saddle on walnut <b>4L-P</b> dark mahogany on walnut <b>25M-P</b> mahogany on walnut <b>25B-P</b> ebony on walnut <b>2ML-P</b> natural maple on maple <b>3ML-P</b> light maple on maple <b>4ML-P</b> medium maple on maple <b>5ML-P</b> cherry on maple <b>6LC-P</b> light cherry on cherry <b>7MC-P</b> medium cherry on cherry <b>8DC-P</b> dark cherry on cherry <b>BB</b> bethany beige <b>CM</b> cardamom fiber <b>SU</b> sugar fiber <b>WH</b> wheat fiber	<b>CU</b> curacao fiber <b>TY</b> thyme fiber <b>CO</b> coriander fiber <b>BA</b> black ashwood <b>GS</b> galvan <b>GV</b> graphite spektrum <b>NV</b> negotiating in geneva <b>NV-G</b> negotiating in geneva gloss <b>OS</b> olive serenity <b>RA</b> rock of ages <b>CF</b> copper fusion <b>CL</b> chili <b>CN</b> cinnamon <b>EW-P</b> eggshell <b>QS</b> quilted stainless <b>BG</b> blackstar granite <b>SB</b> satin brush med. bronze	<b>BR</b> butterum granite <b>GT</b> graphite swirl <b>BF</b> black faux marble <b>LH</b> light hammer copper <b>CP</b> copper maple leaves <b>CE</b> celery fiber <b>AS</b> alumasteel <b>SPL</b> <b>Designer palette*</b> (\$179 list upcharge per stand-off) <b>MR</b> mercury stria <b>BS</b> bronze stria <b>IO</b> iridescent oxide slate	<b>88M-W</b> mahogany on cherry <b>NB-W</b> natural birch on birch <b>MB-W</b> mocha birch <b>CB-W</b> cherry on birch <b>6LC-W</b> light cherry on birch	<b>7MC-W</b> medium cherry on birch <b>8DC-W</b> dark cherry on birch <b>3L-W</b> saddle on walnut <b>2KL-W</b> sepia on walnut <b>4L-W</b> dark mahogany on walnut <b>25M-W</b> mahogany on walnut <b>25B-W</b> ebony on walnut <b>25C-W</b> cherry on walnut <b>1NC-W</b> natural cherry on cherry <b>2HC-W</b> honey cherry on cherry <b>2ML-W</b> natural maple on maple <b>3ML-W</b> light maple on maple <b>4ML-W</b> medium maple on maple <b>5ML-W</b> cherry on maple <b>6LC-W</b> light cherry on cherry <b>7MC-W</b> medium cherry on cherry <b>8DC-W</b> dark cherry on cherry <b>9BC-W</b> burgundy cherry on cherry
-----------------	---	--	--	---	--

45SCS4844-25M-TS-EW  
45SCS4844-25M-AS-EW  
45SCS4844-25M-BOTH-EW

series - unit identification (section) size - finish - options (molding) - stand-offs - finish  
when ordering Typical's - specify Typical "letter"-finish - finish - stand-off options

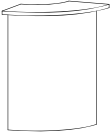
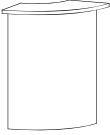
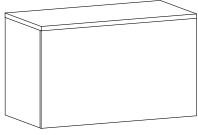
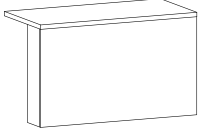
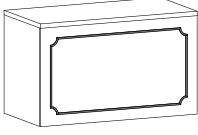
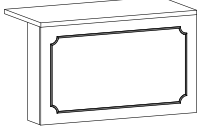
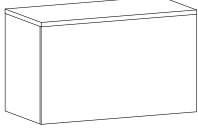
							base unit	
							zone 1	zone 2
	model number		d	w	h	freight		
	46CCR44 - _ _ _ - _ _ _ _ _	44" curved corner right	29	29	44	class 125	4,863	5,253
	45CCR44 - _ _ _ - _ _ _ _ _						4,238	4,578
	46CCL44 - _ _ _ - _ _ _ _ _	44" curved corner left hand	29	29	44	class 125	4,863	5,253
	45CCL44 - _ _ _ - _ _ _ _ _						4,238	4,578
	46R48R - _ _ _ - _ _ _ _ _	run off right hand	24	48	29	class 125	1,501	1,621
	45R48R - _ _ _ - _ _ _ _ _						1,215	1,312
	46R48L - _ _ _ - _ _ _ _ _	run off left hand	24	48	29	class 125	1,501	1,621
	45R48L - _ _ _ - _ _ _ _ _						1,215	1,312
	46R48R-M - _ _ _ _ _ _	run off right hand with molding	24	48	29	class 125	1,646	1,778
	45R48R-M - _ _ _ _ _ _						1,360	1,469
	46R48L-M - _ _ _ _ _ _	run off left hand with molding	24	48	29	class 125	1,646	1,778
	45R48L-M - _ _ _ _ _ _						1,360	1,469
	46R60R - _ _ _ - _ _ _ _ _	run off right hand	24	60	29	class 125	2,085	2,251
	45R60R - _ _ _ - _ _ _ _ _						1,522	1,644

**top material** 45 laminate top  
46 veneer top

**TS top stand-off options**

**AS approach stand-off options**

**edge**

**avonite™** top & approach stand-offs may be specified with avonite™ call for pricing

**glass stand-offs** custom etching available with as a special with an additional upcharge standard color is silver -optional black available  
**edge** edge detail available for approach side only  
**chemcast** also available as stand-off. Call for pricing information

**SPL\*** special laminate may be ordered at a 5% upcharge, plus \$77.00 net freight fee- must provide manufacturer and item number

If top (not standoff) is a different color than chassis (not standoff) indicate that on order (no upcharge)



welcome

4600 series  
4500 series

wood top, veneer chassis  
laminate top, veneer chassis

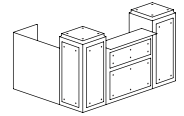

welcome  
4600/4500

laminate stand-off						veneer stand-off						acrilux stand-off						glass stand-off					
TS		AS		BOTH		TS		AS		BOTH		TS		AS		BOTH		TS		AS		BOTH	
zone 1	zone 2	zone 1	zone 2	zone 1	zone 2	zone 1	zone 2	zone 1	zone 2	zone 1	zone 2	zone 1	zone 2	zone 1	zone 2	zone 1	zone 2	zone 1	zone 2	zone 1	zone 2	zone 1	zone 2
5,887	6,359	6,290	6,793	7,314	7,900	7,628	8,238	6,577	7,103	9,340	10,087	6,667	7,201	6,693	7,230	8,497	9,177	8,783	9,486	-	-	-	-
5,261	5,682	5,665	6,118	6,688	7,223	7,001	7,657	5,951	6,427	8,715	9,412	6,041	6,525	6,068	6,554	7,871	8,502	8,158	8,810	-	-	-	-
5,887	6,359	6,290	6,793	7,314	7,900	7,628	8,238	6,577	7,103	9,340	10,087	6,667	7,201	6,693	7,230	8,497	9,177	8,783	9,485	-	-	-	-
5,261	5,682	5,665	6,118	6,688	7,223	7,001	7,561	5,951	6,427	8,715	9,412	6,041	6,525	6,068	6,554	7,871	8,502	8,158	8,810	-	-	-	-
-	-	2,927	3,162	-	-	-	-	3,252	3,511	-	-	-	-	3,342	3,609	-	-	-	-	4,784	5,167	-	-
-	-	2,642	2,853	-	-	-	-	2,965	3,203	-	-	-	-	3,055	3,299	-	-	-	-	4,498	4,857	-	-
-	-	2,927	3,162	-	-	-	-	3,252	3,511	-	-	-	-	3,342	3,609	-	-	-	-	4,784	5,167	-	-
-	-	2,642	2,853	-	-	-	-	2,965	3,203	-	-	-	-	3,055	3,299	-	-	-	-	4,498	4,857	-	-
-	-	-	-	-	-	-	-	-	-	-	-	-	-	-	-	-	-	-	-	-	-	-	-
-	-	-	-	-	-	-	-	-	-	-	-	-	-	-	-	-	-	-	-	-	-	-	-
-	-	3,872	4,182	-	-	-	-	4,275	4,617	-	-	-	-	4,392	4,743	-	-	-	-	6,189	6,685	-	-
-	-	3,310	3,575	-	-	-	-	3,713	4,010	-	-	-	-	3,829	4,136	-	-	-	-	5,627	6,077	-	-

<b>laminat</b>	<b>NB-P</b> natural birch on birch	<b>CU</b> curacao fiber	<b>BR</b> butterum granite	<b>7MC-W</b> medium cherry on birch
<b>MB-P</b> mocha on birch	<b>TY</b> thyme fiber	<b>GT</b> graphite swirl	<b>BT</b> black faux marble	<b>8DC-W</b> dark cherry on birch
<b>CB-P</b> cherry on birch	<b>CO</b> coriander fiber	<b>LH</b> light hammer copper	<b>BF</b> black ashwood	<b>3L-W</b> saddle on walnut
<b>3L-P</b> saddle on walnut	<b>BA</b> black ashwood	<b>CP</b> copper maple leaves	<b>LH</b> light hammer copper	<b>2KL-W</b> sepia on walnut
<b>4L-P</b> dark mahogany on walnut	<b>GS</b> galvan	<b>CE</b> celery fiber	<b>CP</b> copper maple leaves	<b>4L-W</b> dark mahogany on walnut
<b>25M-P</b> mahogany on walnut	<b>NV</b> negotiating in geneva	<b>AS</b> alumasteel	<b>CE</b> celery fiber	<b>25M-W</b> mahogany on walnut
<b>25B-P</b> ebony on walnut	<b>NV-G</b> negotiating in geneva gloss	<b>SPL</b> Designer palette* (\$179 list upcharge per stand-off)	<b>AS</b> alumasteel	<b>25B-W</b> ebony on walnut
<b>2ML-P</b> natural maple on maple	<b>OS</b> olive serenity	<b>MR</b> mercury stria	<b>SPL</b> Designer palette* (\$179 list upcharge per stand-off)	<b>25C-W</b> cherry on walnut
<b>3ML-P</b> light maple on maple	<b>RA</b> rock of ages	<b>BS</b> bronze stria	<b>MR</b> mercury stria	<b>1NC-W</b> natural cherry on cherry
<b>4ML-P</b> medium maple on maple	<b>CF</b> copper fusion	<b>IO</b> iridescent oxide slate	<b>BS</b> bronze stria	<b>2HC-W</b> honey cherry on cherry
<b>5ML-P</b> cherry on maple	<b>CL</b> chili	<b>88M-W</b> mahogany on cherry	<b>IO</b> iridescent oxide slate	<b>2ML-W</b> natural maple on maple
<b>6LC-P</b> light cherry on cherry	<b>CN</b> cinnamon	<b>NB-W</b> natural birch on birch		<b>3ML-W</b> light maple on maple
<b>7MC-P</b> medium cherry on cherry	<b>EW-P</b> eggshell	<b>MB-W</b> mocha birch		<b>4ML-W</b> medium maple on maple
<b>8DC-P</b> dark cherry on cherry	<b>QS</b> quilted stainless	<b>CB-W</b> cherry on birch		<b>5ML-W</b> cherry on maple
<b>BB</b> bethany beige	<b>BG</b> blackstar granite	<b>6LC-W</b> light cherry on birch		<b>6LC-W</b> light cherry on cherry
<b>CM</b> cardamom fiber	<b>SB</b> satin brush med. bronze			<b>7MC-W</b> medium cherry on cherry
<b>SU</b> sugar fiber				<b>8DC-W</b> dark cherry on cherry
<b>WH</b> wheat fiber				<b>9BC-W</b> burgundy cherry on cherry



45SCS4844-25M-TS-EW  
45SCS4844-25M-AS-EW  
45SCS4844-25M-BOTH-EW

series - unit identification (section) size - finish - options (molding) - stand-offs - finish  
when ordering Typical's - specify Typical "letter"-finish - finish - stand-off options

welcome  
4600/4500

						base unit		
model number		d w h			freight	zone 1	zone 2	
	46R60L - _ _ _ _ _	run off left hand	24	60	29	class 125	2,085	2,251
	45R60L - _ _ _ _ _						1,522	1,644
	46R60R-M - _ _ _	run off right hand with molding	24	60	29	class 125	2,233	2,517
	45R60R-M - _ _ _						1,671	1,804
	46R60L-M - _ _ _	run off left hand with molding	24	60	29	class 125	2,233	2,517
	45R60L-M - _ _ _						1,671	1,804
	46RA48R - _ _ _ _	run off right hand  ADA ACCESSIBLE	24	48	29	class 125	2,223	2,401
	45RA48R - _ _ _ _						1,936	2,091
	46RA48L - _ _ _ _	run off left hand  ADA ACCESSIBLE	24	48	29	class 125	2,223	2,401
	45RA48L - _ _ _ _						1,936	2,091
	46RA48R-M - _ _	run off right hand with molding  ADA ACCESSIBLE	24	48	29	class 125	2,370	2,561
	45RA48R-M - _ _						2,085	2,251
	46RA48L-M - _ _	run off left hand with molding  ADA ACCESSIBLE	24	48	29	class 125	2,370	2,561
	45RA48L-M - _ _						2,085	2,251

**top material** 45 laminate top  
46 veneer top

**TS top stand-off options**

**AS approach stand-off options**

**edge**

**avonite™** top & approach stand-offs may be specified with avonite™ call for pricing

**glass stand-offs** custom etching available with as a special with an additional upcharge standard color is silver -optional black available  
**edge** edge detail available for approach side only  
**chemcast** also available as stand-off. Call for pricing information

**SPL\*** special laminate may be ordered at a 5% upcharge, plus \$77.00 net freight fee- must provide manufacturer and item number

If top (not standoff) is a different color than chassis (not standoff) indicate that on order (no upcharge)



welcome

4600 series  
4500 series

wood top, veneer chassis  
laminate top, veneer chassis

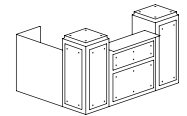

welcome  
4600/4500

laminate stand-off						veneer stand-off						acrilux stand-off						glass stand-off					
TS		AS		BOTH		TS		AS		BOTH		TS		AS		BOTH		TS		AS		BOTH	
zone 1	zone 2	zone 1	zone 2	zone 1	zone 2	zone 1	zone 2	zone 1	zone 2	zone 1	zone 2	zone 1	zone 2	zone 1	zone 2	zone 1	zone 2	zone 1	zone 2	zone 1	zone 2	zone 1	zone 2
-	-	3,872	4,182	-	-	-	-	4,275	4,617	-	-	-	-	4,392	4,743	-	-	-	-	6,189	6,685	-	-
-	-	3,310	3,575	-	-	-	-	3,713	4,010	-	-	-	-	3,829	4,136	-	-	-	-	5,627	6,077	-	-
-	-	-	-	-	-	-	-	-	-	-	-	-	-	-	-	-	-	-	-	-	-	-	-
-	-	-	-	-	-	-	-	-	-	-	-	-	-	-	-	-	-	-	-	-	-	-	-
-	-	2,960	3,197	-	-	-	-	3,098	3,346	-	-	-	-	3,188	3,443	-	-	-	-	3,867	4,176	-	-
-	-	2,673	2,888	-	-	-	-	2,811	3,036	-	-	-	-	2,901	3,133	-	-	-	-	3,580	3,867	-	-
-	-	2,960	3,197	-	-	-	-	3,098	3,346	-	-	-	-	3,188	3,443	-	-	-	-	3,867	4,176	-	-
-	-	2,673	2,888	-	-	-	-	2,811	3,036	-	-	-	-	2,901	3,133	-	-	-	-	3,580	3,867	-	-
-	-	-	-	-	-	-	-	-	-	-	-	-	-	-	-	-	-	-	-	-	-	-	-
-	-	-	-	-	-	-	-	-	-	-	-	-	-	-	-	-	-	-	-	-	-	-	-

<b>laminate</b>	<b>NB-P</b> natural birch on birch	<b>CU</b> curacao fiber	<b>BR</b> butterum granite	<b>7MC-W</b> medium cherry on birch
<b>MB-P</b> mocha on birch	<b>TY</b> thyme fiber	<b>GT</b> graphite swirl	<b>8DC-W</b> dark cherry on birch	<b>8DC-W</b> dark cherry on birch
<b>CB-P</b> cherry on birch	<b>CO</b> coriander fiber	<b>BF</b> black faux marble	<b>3L-W</b> saddle on walnut	<b>3L-W</b> saddle on walnut
<b>3L-P</b> saddle on walnut	<b>BA</b> black ashwood	<b>LH</b> light hammer copper	<b>2KL-W</b> sepia on walnut	<b>2KL-W</b> sepia on walnut
<b>4L-P</b> dark mahogany on walnut	<b>GS</b> galvan	<b>CP</b> copper maple leaves	<b>4L-W</b> dark mahogany on walnut	<b>4L-W</b> dark mahogany on walnut
<b>25M-P</b> mahogany on walnut	<b>NV</b> graphite spektrum	<b>CE</b> celery fiber	<b>25M-W</b> mahogany on walnut	<b>25M-W</b> mahogany on walnut
<b>25B-P</b> ebony on walnut	<b>NV-G</b> negotiating in geneva	<b>AS</b> alumasteel	<b>25B-W</b> ebony on walnut	<b>25B-W</b> ebony on walnut
<b>2ML-P</b> natural maple on maple	<b>OS</b> negotiating in geneva gloss	<b>SPL</b> Designer palette* (\$179 list upcharge per stand-off)	<b>25C-W</b> cherry on walnut	<b>25C-W</b> cherry on walnut
<b>3ML-P</b> light maple on maple	<b>RA</b> rock of ages	<b>MR</b> mercury stria	<b>1NC-W</b> natural cherry on cherry	<b>1NC-W</b> natural cherry on cherry
<b>4ML-P</b> medium maple on maple	<b>CF</b> copper fusion	<b>BS</b> bronze stria	<b>2HC-W</b> honey cherry on cherry	<b>2HC-W</b> honey cherry on cherry
<b>5ML-P</b> cherry on maple	<b>CL</b> chili	<b>IO</b> iridescent oxide slate	<b>2ML-W</b> natural maple on maple	<b>2ML-W</b> natural maple on maple
<b>6LC-P</b> light cherry on cherry	<b>CN</b> cinnamon		<b>3ML-W</b> light maple on maple	<b>3ML-W</b> light maple on maple
<b>7MC-P</b> medium cherry on cherry	<b>EW-P</b> eggshell		<b>4ML-W</b> medium maple on maple	<b>4ML-W</b> medium maple on maple
<b>8DC-P</b> dark cherry on cherry	<b>QS</b> quilted stainless	<b>veneer</b>	<b>5ML-W</b> cherry on maple	<b>5ML-W</b> cherry on maple
<b>BB</b> bethany beige	<b>BG</b> blackstar granite		<b>6LC-W</b> light cherry on cherry	<b>6LC-W</b> light cherry on cherry
<b>CM</b> cardamom fiber	<b>SB</b> satin brush med. bronze		<b>7MC-W</b> medium cherry on cherry	<b>7MC-W</b> medium cherry on cherry
<b>SU</b> sugar fiber			<b>8DC-W</b> dark cherry on cherry	<b>8DC-W</b> dark cherry on cherry
<b>WH</b> wheat fiber			<b>9BC-W</b> burgundy cherry on cherry	<b>9BC-W</b> burgundy cherry on cherry

45SCS4844-25M-TS-EW  
45SCS4844-25M-AS-EW  
45SCS4844-25M-BOTH-EW

series - unit identification (section) size - finish - options (molding) - stand-offs - finish  
when ordering Typical's - specify Typical "letter"-finish - finish - stand-off options

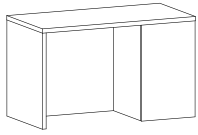
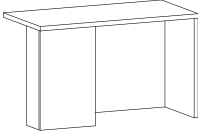
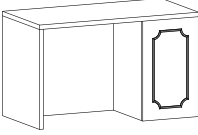
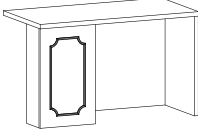
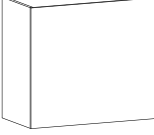
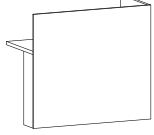
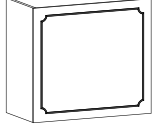
						base unit		
model number						zone 1	zone 2	
d w h freight						zone 1	zone 2	
	46RA60R - _ _ _ -	run off right hand	24	60	29	class 125	2,987	3,225
	45RA60R - _ _ _ -	ADA ACCESSIBLE					2,424	2,618
	46RA60L - _ _ _ -	run off left hand	24	60	29	class 125	2,987	3,225
	45RA60L - _ _ _ -	ADA ACCESSIBLE					2,424	2,618
	46RA60R-M - _ _ -	run off right hand with molding	24	60	29	class 125	3,134	3,385
	45RA60R-M - _ _ -	ADA ACCESSIBLE					2,572	2,778
	46RA60L-M - _ _ -	run off left hand with molding	24	60	29	class 125	3,134	3,385
	45RA60L-M - _ _ -	ADA ACCESSIBLE					2,572	2,778
	46RP48R - _ _ _ -	privacy panel run off right hand	24	48	43	class 125	1,979	2,137
	45RP48R - _ _ _ -						1,692	1,828
	46RP48L - _ _ _ -	privacy panel run off left hand	24	48	43	class 125	1,979	2,137
	45RP48L - _ _ _ -						1,692	1,828
	46RP48R-M - _ _ -	privacy panel run off right hand with molding	24	48	43	class 125	2,148	2,319
	45RP48R-M - _ _ -						1,862	2,010

**top material** 45 laminate top  
46 veneer top

**TS top stand-off options**

**AS approach stand-off options**

**edge**

**avonite™** top & approach stand-offs may be specified with avonite™ call for pricing

**glass** custom etching available with as a special with an additional upcharge  
**stand-offs** standard color is silver -optional black available  
**edge** edge detail available for approach side only  
**chemcast** also available as stand-off. Call for pricing information

**SPL\*** special laminate may be ordered at a 5% upcharge, plus \$77.00 net freight fee- must provide manufacturer and item number

If top (not standoff) is a different color than chassis (not standoff) indicate that on order (no upcharge)



welcome

4600 series  
4500 series

wood top, veneer chassis  
laminate top, veneer chassis

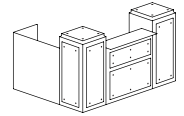

welcome  
4600/4500

laminate stand-off						veneer stand-off						acrilux stand-off						glass stand-off					
TS		AS		BOTH		TS		AS		BOTH		TS		AS		BOTH		TS		AS		BOTH	
zone 1	zone 2	zone 1	zone 2	zone 1	zone 2	zone 1	zone 2	zone 1	zone 2	zone 1	zone 2	zone 1	zone 2	zone 1	zone 2	zone 1	zone 2	zone 1	zone 2	zone 1	zone 2	zone 1	zone 2
-	-	3,909	4,222	-	-	-	-	4,079	4,405	-	-	-	-	4,195	4,531	-	-	-	-	5,039	5,442	-	-
-	-	3,347	3,614	-	-	-	-	3,517	3,797	-	-	-	-	3,633	3,924	-	-	-	-	4,477	4,835	-	-
-	-	3,909	4,222	-	-	-	-	4,079	4,405	-	-	-	-	4,195	4,531	-	-	-	-	5,039	5,442	-	-
-	-	3,347	3,614	-	-	-	-	3,517	3,797	-	-	-	-	3,633	3,924	-	-	-	-	4,477	4,835	-	-
-	-	-	-	-	-	-	-	-	-	-	-	-	-	-	-	-	-	-	-	-	-	-	-
-	-	-	-	-	-	-	-	-	-	-	-	-	-	-	-	-	-	-	-	-	-	-	-
-	-	5,596	6,044	-	-	-	-	5,919	6,392	-	-	-	-	6,100	6,587	-	-	-	-	12,501	13,502	-	-
-	-	5,309	5,733	-	-	-	-	5,632	6,083	-	-	-	-	5,813	6,278	-	-	-	-	12,216	13,192	-	-
-	-	5,596	6,044	-	-	-	-	5,919	6,392	-	-	-	-	6,100	6,587	-	-	-	-	12,501	13,502	-	-
-	-	5,309	5,733	-	-	-	-	5,632	6,083	-	-	-	-	5,813	6,278	-	-	-	-	12,216	13,192	-	-
-	-	-	-	-	-	-	-	-	-	-	-	-	-	-	-	-	-	-	-	-	-	-	-
-	-	-	-	-	-	-	-	-	-	-	-	-	-	-	-	-	-	-	-	-	-	-	-

<b>laminate</b>	<b>NB-P</b> natural birch on birch	<b>CU</b> curacao fiber	<b>BR</b> butterum granite	<b>7MC-W</b> medium cherry on birch
<b>MB-P</b> mocha on birch	<b>TY</b> thyme fiber	<b>GT</b> graphite swirl	<b>8DC-W</b> dark cherry on birch	<b>8DC-W</b> dark cherry on birch
<b>CB-P</b> cherry on birch	<b>CO</b> coriander fiber	<b>BF</b> black faux marble	<b>3L-W</b> saddle on walnut	<b>3L-W</b> saddle on walnut
<b>3L-P</b> saddle on walnut	<b>BA</b> black ashwood	<b>LH</b> light hammer copper	<b>2KL-W</b> sepia on walnut	<b>2KL-W</b> sepia on walnut
<b>4L-P</b> dark mahogany on walnut	<b>GS</b> galvan	<b>CP</b> copper maple leaves	<b>4L-W</b> dark mahogany on walnut	<b>4L-W</b> dark mahogany on walnut
<b>25M-P</b> mahogany on walnut	<b>NV</b> graphite spektrum	<b>CE</b> celery fiber	<b>25M-W</b> mahogany on walnut	<b>25M-W</b> mahogany on walnut
<b>25B-P</b> ebony on walnut	<b>NV-G</b> negotiating in geneva	<b>AS</b> alumasteel	<b>25B-W</b> ebony on walnut	<b>25B-W</b> ebony on walnut
<b>2ML-P</b> natural maple on maple	<b>OS</b> negotiating in geneva gloss	<b>SPL</b> Designer palette* (\$179 list upcharge per stand-off)	<b>25C-W</b> cherry on walnut	<b>25C-W</b> cherry on walnut
<b>3ML-P</b> light maple on maple	<b>RA</b> rock of ages	<b>MR</b> mercury stria	<b>1NC-W</b> natural cherry on cherry	<b>1NC-W</b> natural cherry on cherry
<b>4ML-P</b> medium maple on maple	<b>CF</b> copper fusion	<b>BS</b> bronze stria	<b>2HC-W</b> honey cherry on cherry	<b>2HC-W</b> honey cherry on cherry
<b>5ML-P</b> cherry on maple	<b>CL</b> chili	<b>IO</b> iridescent oxide slate	<b>2ML-W</b> natural maple on maple	<b>2ML-W</b> natural maple on maple
<b>6LC-P</b> light cherry on cherry	<b>CN</b> cinnamon		<b>3ML-W</b> light maple on maple	<b>3ML-W</b> light maple on maple
<b>7MC-P</b> medium cherry on cherry	<b>CN</b> cinnamon		<b>4ML-W</b> medium maple on maple	<b>4ML-W</b> medium maple on maple
<b>8DC-P</b> dark cherry on cherry	<b>EW-P</b> eggshell		<b>5ML-W</b> light cherry on maple	<b>5ML-W</b> light cherry on maple
<b>BB</b> bethany beige	<b>QS</b> quilted stainless	<b>veneer</b>	<b>6LC-W</b> light cherry on cherry	<b>6LC-W</b> light cherry on cherry
<b>CM</b> cardamom fiber	<b>BG</b> blackstar granite		<b>7MC-W</b> medium cherry on cherry	<b>7MC-W</b> medium cherry on cherry
<b>SU</b> sugar fiber	<b>SB</b> satin brush med. bronze		<b>8DC-W</b> dark cherry on cherry	<b>8DC-W</b> dark cherry on cherry
<b>WH</b> wheat fiber			<b>9BC-W</b> burgundy cherry on cherry	<b>9BC-W</b> burgundy cherry on cherry

45SCS4844-25M-TS-EW  
45SCS4844-25M-AS-EW  
45SCS4844-25M-BOTH-EW

series - unit identification (section) size - finish - options (molding) - stand-offs - finish  
when ordering Typical's - specify Typical "letter"-finish - finish - stand-off options

welcome  
4600/4500

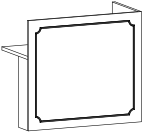
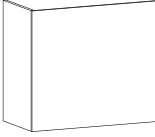
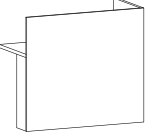
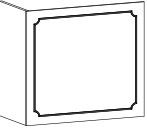
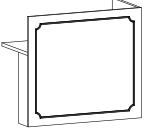
							base unit	
		model number	d	w	h	freight	zone 1	zone 2
	46RP48L-M - - - -	privacy panel run off left hand with molding	24	48	43	class 125	2,148	2,319
	45RP48L-M - - - -						1,862	2,010
	46RP60R - - - -	privacy panel run off right hand	24	60	43	class 125	2,684	2,898
	45RP60R - - - -						2,122	2,291
	46RP60L - - - -	privacy panel run off left hand	24	60	43	class 125	2,684	2,898
	45RP60L - - - -						2,122	2,291
	46RP60R-M - - - -	privacy panel run off right hand with molding	24	60	43	class 125	2,854	3,081
	45RP60R-M - - - -						2,291	2,475
	46RP60L-M - - - -	privacy panel run off left hand with holding	24	60	43	class 125	2,854	3,081
	45RP60L-M - - - -						2,291	2,475

top material  
TS top stand-off options  
AS approach stand-off options  
edge

45 laminate top veneer top  
46 laminate veneer acrilux glass C.O.M.  
laminate veneer acrilux glass C.O.M.

avonite™ top & approach stand-offs may be specified with avonite™ call for pricing  
glass custom etching available with as a special with an additional upcharge  
stand-offs standard color is silver -optional black available  
edge edge detail available for approach side only  
chemcast also available as stand-off. Call for pricing information

SPL\* special laminate may be ordered at a 5% upcharge, plus \$77.00 net freight fee- must provide manufacturer and item number

If top (not standoff) is a different color than chassis (not standoff) indicate that on order (no upcharge)



welcome

4600 series  
4500 series

wood top, veneer chassis  
laminate top, veneer chassis

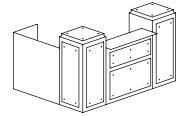



welcome  
4600/4500

laminate stand-off						veneer stand-off						acrilux stand-off						glass stand-off					
TS		AS		BOTH		TS		AS		BOTH		TS		AS		BOTH		TS		AS		BOTH	
zone 1	zone 2	zone 1	zone 2	zone 1	zone 2	zone 1	zone 2	zone 1	zone 2	zone 1	zone 2	zone 1	zone 2	zone 1	zone 2	zone 1	zone 2	zone 1	zone 2	zone 1	zone 2	zone 1	zone 2
-	-	-	-	-	-	-	-	-	-	-	-	-	-	-	-	-	-	-	-	-	-	-	-
-	-	7,208	7,786	-	-	-	-	7,611	8,220	-	-	-	-	7,792	8,415	-	-	-	-	15,838	17,104	-	-
-	-	6,646	7,178	-	-	-	-	7,049	7,613	-	-	-	-	7,230	7,807	-	-	-	-	15,276	16,497	-	-
-	-	7,208	7,786	-	-	-	-	7,611	8,220	-	-	-	-	7,792	8,415	-	-	-	-	15,838	17,104	-	-
-	-	6,646	7,178	-	-	-	-	7,049	7,613	-	-	-	-	7,230	7,807	-	-	-	-	15,276	16,497	-	-
-	-	-	-	-	-	-	-	-	-	-	-	-	-	-	-	-	-	-	-	-	-	-	-
-	-	-	-	-	-	-	-	-	-	-	-	-	-	-	-	-	-	-	-	-	-	-	-

<b>laminate</b>	<b>NB-P</b> natural birch on birch	<b>CU</b> curacao fiber	<b>BR</b> butterum granite	<b>7MC-W</b> medium cherry on birch
<b>MB-P</b> mocha on birch	<b>TY</b> thyme fiber	<b>GT</b> graphite swirl	<b>8DC-W</b> dark cherry on birch	<b>3L-W</b> saddle on walnut
<b>CB-P</b> cherry on birch	<b>CO</b> coriander fiber	<b>BF</b> black faux marble	<b>2KL-W</b> sepia on walnut	<b>4L-W</b> dark mahogany on walnut
<b>3L-P</b> saddle on walnut	<b>BA</b> black ashwood	<b>LH</b> light hammer copper	<b>25M-W</b> mahogany on walnut	<b>25B-W</b> ebony on walnut
<b>4L-P</b> dark mahogany on walnut	<b>GV</b> galvan	<b>CP</b> copper maple leaves	<b>25C-W</b> cherry on walnut	<b>1NC-W</b> natural cherry on cherry
<b>25M-P</b> mahogany on walnut	<b>GS</b> graphite spektrum	<b>CE</b> celery fiber	<b>25B-W</b> ebony on walnut	<b>2HC-W</b> honey cherry on cherry
<b>25B-P</b> ebony on walnut	<b>NV-G</b> negotiating in geneva	<b>AS</b> alumasteel	<b>25C-W</b> cherry on walnut	<b>2ML-W</b> natural maple on maple
<b>2ML-P</b> natural maple on maple	<b>OS</b> olive serenity	<b>SPL</b> Designer palette* (\$179 list upcharge per stand-off)	<b>1NC-W</b> natural cherry on cherry	<b>3ML-W</b> light maple on maple
<b>3ML-P</b> light maple on maple	<b>RA</b> rock of ages	<b>MR</b> mercury stria	<b>2ML-W</b> natural maple on maple	<b>4ML-W</b> light maple on maple
<b>4ML-P</b> medium maple on maple	<b>CF</b> copper fusion	<b>BS</b> bronze stria	<b>3ML-W</b> light maple on maple	<b>5ML-W</b> cherry on maple
<b>5ML-P</b> cherry on maple	<b>CL</b> chili	<b>IO</b> iridescent oxide slate	<b>4ML-W</b> light maple on maple	<b>6LC-W</b> light cherry on cherry
<b>6LC-P</b> light cherry on cherry	<b>CN</b> cinnamon		<b>5ML-W</b> cherry on maple	<b>7MC-W</b> medium cherry on cherry
<b>7MC-P</b> medium cherry on cherry	<b>EW-P</b> eggshell		<b>6LC-W</b> medium maple on maple	<b>8DC-W</b> dark cherry on cherry
<b>8DC-P</b> dark cherry on cherry	<b>QS</b> quilted stainless	<b>veneer</b>	<b>7MC-W</b> medium cherry on cherry	<b>9BC-W</b> burgundy cherry on cherry
<b>BB</b> bethany beige	<b>BG</b> blackstar granite		<b>8DC-W</b> dark cherry on cherry	
<b>CM</b> cardamom fiber	<b>SB</b> satin brush med. bronze		<b>9BC-W</b> burgundy cherry on cherry	
<b>SU</b> sugar fiber				
<b>WH</b> wheat fiber				

45SCS4844-25M-TS-EW  
45SCS4844-25M-AS-EW  
45SCS4844-25M-BOTH-EW

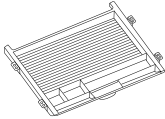
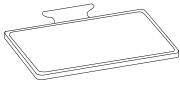
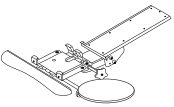
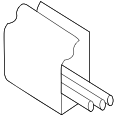
series - unit identification (section) size - finish - options (molding) - stand-offs - finish  
when ordering Typical - specify Typical "letter"-finish - finish - stand-off options

	model number	description		freight	list \$ zone 1	list \$ zone 2
	<b>MT</b>	fold out and tilting mouse tray for right hand or left hand  <i>FOR USE WITH KBP, FIELD INSTALLATION ONLY</i>		class 100 cwt 5 lb cu ft .5	<b>180</b>	<b>194</b>
	<b>CDP</b> <b>CDP-I</b>	center drawer black plastic  <i>CANNOT BE FACTORY INSTALLED IN BRIDGES, CORNER UNITS OR ANY TREK 2500 SURFACES. PLEASE SPECIFY UNIT ON WHICH TO BE INSTALLED FACTORY INSTALLED ONLY</i>	19 24.3 1.8	class 100 cwt 5 lb cu ft 1	<b>197</b>	<b>197</b>
	<b>KBP</b> <b>KBP-I</b>	plastic keyboard platform  <i>ARTICULATING KEYBOARD CONTROLS HEIGHT ADJUSTMENT FROM 26.5" - 29" CANNOT BE FACTORY INSTALLED IN BRIDGES, CORNER UNITS OR ANY TREK 2500 SURFACES. PLEASE SPECIFY UNIT ON WHICH TO BE INSTALLED FACTORY INSTALLED ONLY</i>	11 23 1.25	cwt 10 lb cu ft .5	<b>377</b>	<b>419</b>
	<b>KBMT</b> <b>KBMT-I</b>	keyboard mechanism with clamp tray adjustable wrist rest and swivel mouse arm; black Wrist - 10.5"x3"x20.5" Mouse - 7 5/16" x 7 5/16" Arm - 10.5" x 4.5" x 19"  <i>HEIGHT ADJUSTABLE FROM 26.5 - 29" FACTORY INSTALLED ONLY</i>		class 100 cwt 15 lb cu ft 1	<b>742</b>	<b>801</b>
	<b>WMC-30</b>	wire/cable management conduit 2.25" x 1" black plastic wire/cable conduit; secures to kneespace or under tops with double sided tape; top opens for wires/cables to slip in and be concealed; customer can cut to length	- 30 -	cwt lb cu ft	<b>122</b>	<b>132</b>
	<b>CPU</b>	vertical off the floor fixed mount CPU holder 360° swivel supports up to 45 lbs steel construction, black finish  <i>FIELD INSTALLED ONLY VERTICAL STORAGE: 14.5 - 22.5" HORIZONTAL ADJUSTMENT: 5.25 - 9.5"</i>		class 100 cwt 15 lb cu ft 1	<b>391</b>	<b>391</b>
	<b>CPU-T</b>	vertical off the floor fixed mount CPU holder 360° swivel supports up to 45 lbs steel construction, black finish *for thinner CPU's  <i>FIELD INSTALLED ONLY VERTICAL STORAGE: 14.5 - 22.5" HORIZONTAL ADJUSTMENT: 2.75 - 5.5"</i>		class 100 cwt 15 lb cu ft 1	<b>379</b>	<b>379</b>

welcome

4600 series  
4500 series

wood top, veneer chassis  
lamine top, veneer chassis

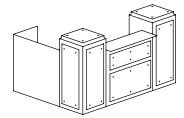

welcome  
4600/4500

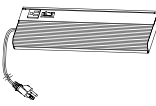
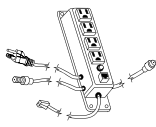
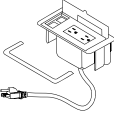
	model number	description	d	w	h	freight	list \$ zone 1	list \$ zone 2
	<b>TL24</b>	task light for use with overhead storage units  <i>FIELD INSTALLED ONLY</i>	7	24	2	class 100 cwt 11 lb cu ft 1	<b>335</b>	<b>364</b>
	<b>PCH</b>	power communications harness mounts in any knee-well or any panel 13 amp circuit breaker; 120 volt, 60hz, 13 amp ratings; 10' power cord; 105 c; 16/3 13 amp; 14' telephone hook up for phone, modem or fax; black  <i>UL NETED CSD CERTIFIED FIELD INSTALLED ONLY</i>				class cwt lb cu ft	<b>265</b>	<b>265</b>
	<b>FPM</b> <b>FPM-I</b>	flip-up power management with two simplex outlets and two communication blanks; black  <i>PLEASE SPECIFY LOCATION FACTORY INSTALLED ONLY</i>				class cwt lb cu ft	<b>538</b>	<b>538</b>



# inwood

OFFICE  
ENVIRONMENTS

## price list

effective 01 january 2012

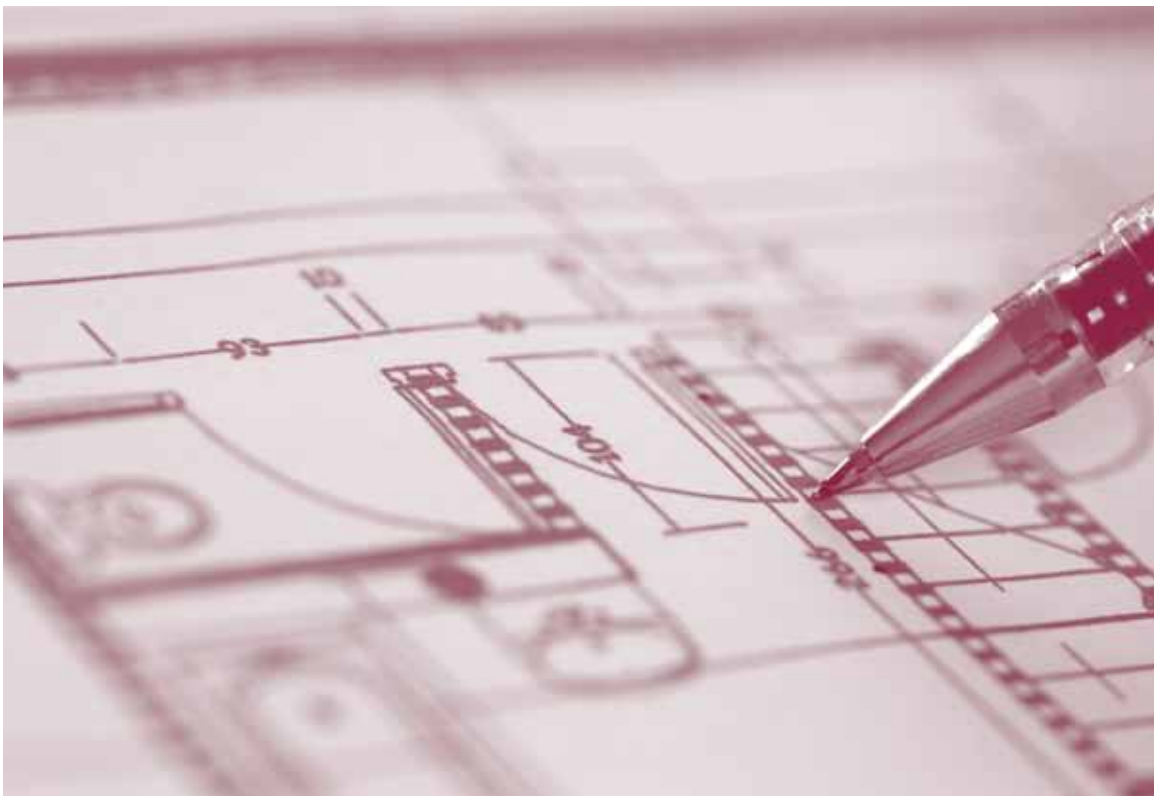

account # \_\_\_\_\_  
discount \_\_\_\_\_  
zone \_\_\_\_\_  
c.s.r. \_\_\_\_\_  
sales rep. \_\_\_\_\_

### muse

2700

[click here for warranty  
and terms information](#)

zones one and two



# inwood

OFFICE  
ENVIRONMENTS

---



muse  
2700

## muse 2700 series specifications

### materials:

All wood is thoroughly air and kiln dried to a moisture content not to exceed 8% at the time of assembly.

### veneers:

All exposed surfaces are rotary sliced Birch. Veneers are carefully slip-matched and balanced. All drawer fronts, doors, end panels, and modesty panels are vertical grain.

### top work surfaces:

Wood veneer tops are 1 1/16" thick, 3-ply construction; consisting of 1/40" thick Birch veneer work surface and a Gator-ply backing. Laminate tops are 1 1/16" thick, 3-ply construction consisting of high pressure laminate work surface and a Gator-ply backing. The top core material is a medium density fiberboard, with a reversed softened edge. Edge detail on all four sides of the work surface.

### modesty panels:

Suspended by 2, 1/4" - 1/2" CR Flat metal brackets, 1/2" thick, 3-ply construction with a vertical veneer on exposed surfaces and a 45 lb density particle board core.

### construction:

Uses a mortise and tenon and glue to join pedestal sides and back. All joints are reinforced with glue blocks. All pedestals have box drawer, file drawer, with an aluminum finish pull standard. Each pedestal has a lock and is keyed alike. All bookcase shelves are standard 3/4" thick.

### drawers:

Drawer fronts are 3/4" thick, 3-ply construction with vertical slip-matched veneer. Drawer edges are squared with matching maple veneer tape on all edges. All drawer sides and backs are plywood, dovetailed front and back with 3-ply drawer bottoms. Drawer bottoms are framed on four sides and stapled from the bottom side. Drawer interiors are finished with a clear coat sealer to prevent swelling or shrinkage. Box drawers have a high grade Sterling metal ball-bearing drawer suspension. File drawers have a high grade Sterling metal ball bearing full progressive suspension and are equipped with metal rods for hanging file folders. All drawers have smooth quiet operation.  
*NOTE: Optional center drawers available.*

### inside drawer dimensions:

box drawers: 4" H x 14 5/8" W x 15 9/16" L  
4" H x 14 5/8" W x 22 1/8" L  
file drawers: 9 1/2" H x 14 5/8" W x 15 9/16" L  
9 1/2" H x 14 5/8" W x 25 3/8" L  
lateral files: 9 1/2" H x 32 5/8" W x 16" L

### legs:

14 Gauge Steel with powder coat finish and leg levelers

### locking:

Each pedestal has its own lock and is keyed alike on each unit. Each unit is equipped with two keys. Units may be keyed alike in groups (per office, if requested) for an additional charge of \$37 list per unit.

### grommets:

Standard silver grommet. Optional black available (no upcharge)

### wire management:

An aluminum extruded channel is used on the underneath worksurface and storage units

### finish:

All Inwood finishes are catalyzed varnish finish. Our multi-step satin finishes leave an open grain natural look to the furniture. Available in following finishes (MB) Mocha on Birch, (NB) Natural on Birch, (CB) Cherry on Birch, (6LC) Light Cherry on Birch, (7MC) Medium Cherry on Birch, (8DC) Dark Cherry on Birch, (2ML) Natural Maple on Birch, (3ML) Light Maple on Birch, (4ML) Medium Maple on Birch, (5ML) Cherry Maple on Birch.

Durasyn is a tinted painted finish with post-catalyzed varnish and acid cured topcoats formulated for superior performance on MDF. Durasyn offers superior scratch, mar, chemical and moisture resistance properties. Durasyn has been enhanced with UV absorbers to further increase UV protection.

### modesty and overhead door options:



chemcast  
doors or modesty



veneer

**instructions for muse product are available online and within product cartons muse is shipped kd and requires assembly**

### online instructions

Inwood Office Environments makes available product instructions for 2700 series Muse office furniture. Please visit [inwood.net](http://inwood.net) and click the instructions link to review the downloadable PDF documents. Any issues? Assistance is only a phone call away. Call 1-800-786-6121 or 1-812-482-6121 for Inwood customer service. Our customer service representatives can talk you through most issues. Need professional service? We would be happy to suggest an authorized dealer or service technician within your area.



**muse**

**desks**

letter  
side to side

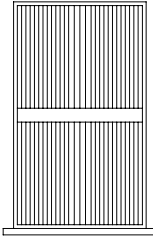

legal  
side to side

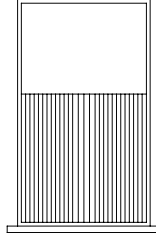

**returns  
and  
credenzas**

letter  
side to side

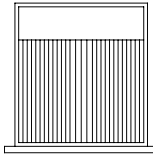

**returns  
and  
credenzas**

legal  
side to side

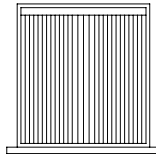

**lateral files**

letter  
front to back

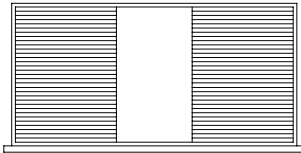

legal  
front to back

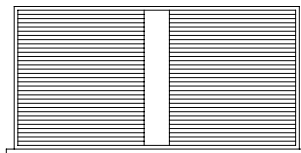

letter  
side to side

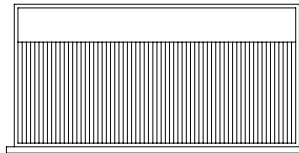

legal  
side to side

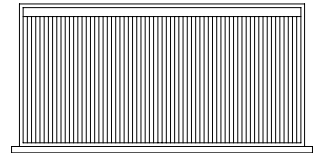

## FBT2784-MB-CB-MB-P

unit identification (type) & top dimension - chassis finish - finish of drawer fronts - top finish - top material

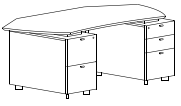
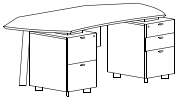
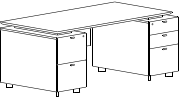
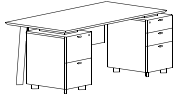
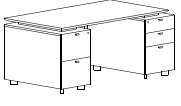
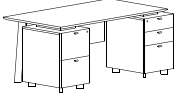
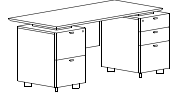
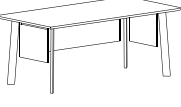
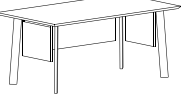
	model number	description	d	w	h	freight	list \$ zone 1	list \$ zone 2
	<b>FBT2784</b> - _ - _ - _ - _ -	bow front double pedestal desk  <i>CHANGE MODESTY TO CHEMCAST \$151</i>	44	84	29	class 125 cwt 425 cu ft 51  <i>KNEESPACE: 31"</i>	<b>4,879</b>	<b>5,270</b>
	<b>FBT2784L</b> - _ - _ - _ - _ -	bow front double pedestal desk with legs  <i>CHANGE MODESTY TO CHEMCAST \$203</i>	44	84	29	class 125 cwt 355 cu ft 46  <i>KNEESPACE: 31"</i>	<b>5,028</b>	<b>5,430</b>
	<b>F2772</b> - _ - _ - _ - _ -	double pedestal desk  <i>CHANGE MODESTY TO CHEMCAST \$151</i>	38	76	29	class 125 cwt 410 cu ft 39  <i>KNEESPACE: 40"</i>	<b>4,660</b>	<b>5,033</b>
	<b>F2772L</b> - _ - _ - _ - _ -	double pedestal desk with legs  <i>CHANGE MODESTY TO CHEMCAST \$203</i>	38	76	29	class 125 cwt 385 cu ft 40  <i>KNEESPACE: 40"</i>	<b>4,732</b>	<b>5,112</b>
	<b>F2766</b> - _ - _ - _ - _ -	double pedestal desk  <i>CHANGE MODESTY TO CHEMCAST \$151</i>	38	70	29	class 125 cwt 415 cu ft 42  <i>KNEESPACE: 34"</i>	<b>4,594</b>	<b>4,960</b>
	<b>F2766L</b> - _ - _ - _ - _ -	double pedestal desk with legs  <i>CHANGE MODESTY TO CHEMCAST \$203</i>	38	70	29	class 125 cwt 388 cu ft 36  <i>KNEESPACE: 34"</i>	<b>4,725</b>	<b>5,102</b>
	<b>F276630</b> - _ - _ - _ - _ -	double pedestal desk  <i>CHANGE MODESTY TO CHEMCAST \$151</i>	32	70	29	class 125 cwt 320 cu ft 37  <i>KNEESPACE: 30"</i>	<b>3,964</b>	<b>4,279</b>
	<b>T2772L</b> - _ - _ - _ - _ -	table desk  <i>CHANGE END PANEL(S) TO CHEMCAST \$174</i> <i>CHANGE MODESTY TO CHEMCAST \$277</i>	36	72	29	class 125 cwt 140 cu ft 17  <i>KNEESPACE: 62"</i>	<b>3,738</b>	<b>4,037</b>
	<b>T2766L</b> - _ - _ - _ - _ -	table desk  <i>CHANGE END PANEL(S) TO CHEMCAST \$174</i> <i>CHANGE MODESTY TO CHEMCAST \$232</i>	36	66	29	class 125 cwt 135 cu ft 17  <i>KNEESPACE: 56"</i>	<b>3,680</b>	<b>3,975</b>

top

**P** laminate top  
**W** veneer top

**muse** feet, legs and modesty holders are powder coated steel. support bar extrusion, wire management trough and pulls are anodized aluminum finish

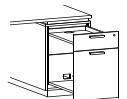

edge

to add laptop ped in any desk (min 36" deep) add \$1,162 zone 1 \ \$1,255 zone 2 list upcharge

muse

2700 series

veneer top, veneer chassis, veneer or durasyn drawer fronts  
 veneer top, veneer chassis, veneer or durasyn drawer fronts  
 laminate top, durasyn chassis, veneer or durasyn drawer fronts  
 veneer top, durasyn chassis, veneer or durasyn drawer fronts

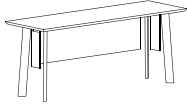
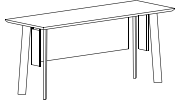
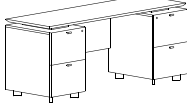
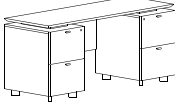
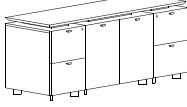
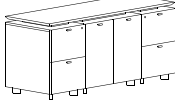
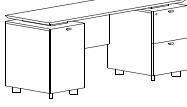
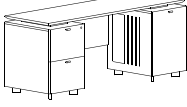
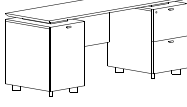

	model number	description	d w h	freight	list \$ zone 1	list \$ zone 2
	<b>T277224L</b> - _ - _ - - -	table desk  <i>CHANGE END PANEL(S) TO CHEMCAST \$58</i> <i>CHANGE MODESTY TO CHEMCAST \$277</i>	23 72 29  <i>KNEESPACE: 62"</i>	class 125 cwt 150 cu ft 7	<b>3,330</b>	<b>3,598</b>
	<b>T276624L</b> - _ - _ - - -	table desk  <i>CHANGE END PANEL(S) TO CHEMCAST \$58</i> <i>CHANGE MODESTY TO CHEMCAST \$232</i>	23 66 29  <i>KNEESPACE: 56"</i>	class 125 cwt 100 cu ft 7	<b>3,313</b>	<b>3,577</b>
	<b>CR2772</b> - _ - _ - - - -	kneespace credenza left and right file/file pedestals  <i>CHANGE MODESTY TO CHEMCAST \$167</i>	24 72 29  <i>KNEESPACE: 36"</i>	class 125 cwt 290 cu ft 25	<b>3,619</b>	<b>3,909</b>
	<b>CR2766</b> - _ - _ - - - -	kneespace credenza left and right file/file pedestals  <i>CHANGE MODESTY TO CHEMCAST \$133</i>	24 66 29  <i>KNEESPACE: 30"</i>	class 125 cwt 280 cu ft 25	<b>3,559</b>	<b>3,844</b>
	<b>CR2772D</b> - _ - _ - - - -	storage credenza left and right file/file pedestals double hinged door center with adjustable shelf	24 72 29	class 125 cwt 385 cu ft 35	<b>4,356</b>	<b>4,705</b>
	<b>CR2766D</b> - _ - _ - - - -	storage credenza left and right file/file pedestal double hinged door center with adjustable shelf	24 66 29	class 125 cwt 365 cu ft 34	<b>4,239</b>	<b>4,578</b>
	<b>CR2772LC</b> - _ - _ - - - -	kneespace credenza right file/file pedestal left cpu pedestal  <i>CHANGE MODESTY TO CHEMCAST \$167</i>	24 72 29  <i>KNEESPACE: 36"</i>	class 125 cwt 268 cu ft 24	<b>3,435</b>	<b>3,710</b>
	<b>CR2772RC</b> - _ - _ - - - -	kneespace credenza left file/file pedestal right cpu pedestal  <i>CHANGE MODESTY TO CHEMCAST \$167</i>	24 72 29  <i>KNEESPACE: 36"</i>	class 125 cwt 268 cu ft 24	<b>3,435</b>	<b>3,710</b>
	<b>CR2766LC</b> - _ - _ - - - -	kneespace credenza right file/file pedestal left cpu pedestal  <i>CHANGE MODESTY TO CHEMCAST \$133</i>	24 66 29  <i>KNEESPACE: 30"</i>	class 125 cwt 258 cu ft 23	<b>3,401</b>	<b>3,672</b>

laminate tops only

**MB-P** mocha on birch laminate  
**NB-P** natural on birch laminate  
**CB-P** cherry on birch laminate  
**EW-P** eggshell white laminate  
**6LC-P** light cherry on birch laminate  
**7MC-P** medium cherry on birch laminate  
**8DC-P** dark cherry on birch laminate  
**2ML-P** natural maple on birch laminate  
**3ML-P** light maple on birch laminate  
**4ML-P** medium maple birch laminate  
**5ML-P** cherry maple on birch laminate

veneer tops only

**6LC-W** light cherry on birch veneer  
**7MC-W** medium cherry on birch veneer  
**8DC-W** dark cherry on birch veneer  
**MB-W** mocha on birch veneer  
**NB-W** natural on birch veneer  
**CB-W** cherry on birch veneer  
**2ML-W** natural maple on birch veneer  
**3ML-W** light maple on birch veneer  
**4ML-W** medium maple on birch veneer  
**5ML-W** cherry maple on birch veneer

veneer or durasyn chassis and fronts only

**MB** mocha on birch veneer  
**NB** natural on birch veneer  
**CB** cherry on birch veneer  
**6LC** light cherry on birch veneer  
**7MC** medium cherry on birch veneer  
**8DC** dark cherry on birch veneer  
**2ML** natural maple on birch veneer  
**3ML** light maple on birch veneer  
**4ML** medium maple birch veneer  
**5ML** cherry maple on birch veneer  
**EW** eggshell white durasyn

muse  
2700

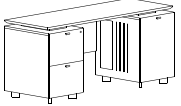
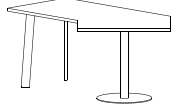
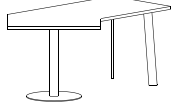
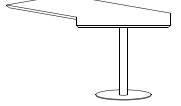
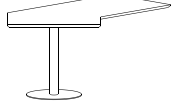
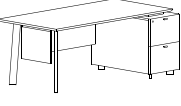
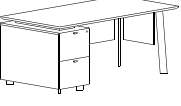
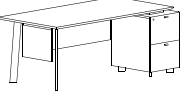
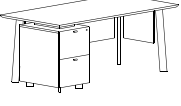
	model number	description	d	w	h	freight	list \$ zone 1	list \$ zone 2
	<b>CR2766RC</b> - _ - _ - _ - _	kneespace credenza left file/file pedestal right cpu pedestal  <i>CHANGE MODESTY TO CHEMCAST \$133</i>	24	66	29	class 125 cwt 258 cu ft 23  <i>KNEESPACE: 30"</i>	<b>3,401</b>	<b>3,672</b>
	<b>E2772R</b> - _ - _	extension top with legs and pedestal base	30-42	72	29	class 125 cwt 125 cu ft 16	<b>3,084</b>	<b>3,331</b>
	<b>E2772L</b> - _ - _	extension top with legs and pedestal base	30-42	72	29	class 125 cwt 125 cu ft 16	<b>3,084</b>	<b>3,331</b>
	<b>EM2772R</b> - _ - _	extension top with pedestal base for attachment to another unit	30-42	72	29	class 125 cwt 105 cu ft 14	<b>2,452</b>	<b>2,651</b>
	<b>EM2772L</b> - _ - _	extension top with pedestal base for attachment to another unit	30-42	72	29	class 125 cwt 105 cu ft 14	<b>2,452</b>	<b>2,651</b>
	<b>D2772R</b> - _ - _ - _ - _	single pedestal desk right file/file pedestal  <i>CHANGE END PANEL(S) TO CHEMCAST \$87</i> <i>CHANGE MODESTY TO CHEMCAST \$226</i>	38	74	29	class 125 cwt 318 cu ft 32  <i>KNEESPACE: 50"</i>	<b>4,236</b>	<b>4,572</b>
	<b>D2772L</b> - _ - _ - _ - _	single pedestal desk left file/file pedestal  <i>CHANGE END PANEL(S) TO CHEMCAST \$87</i> <i>CHANGE MODESTY TO CHEMCAST \$226</i>	38	74	29	class 125 cwt 318 cu ft 32  <i>KNEESPACE: 50"</i>	<b>4,236</b>	<b>4,572</b>
	<b>D2772RL</b> - _ - _ - _ - _	single pedestal desk right file/file leg pedestal  <i>CHANGE END PANEL(S) TO CHEMCAST \$87</i> <i>CHANGE MODESTY TO CHEMCAST \$226</i>	38	74	29	class 125 cwt 288 cu ft 31  <i>KNEESPACE: 50"</i>	<b>4,660</b>	<b>5,033</b>
	<b>D2772LL</b> - _ - _ - _ - _	single pedestal desk left file/file leg pedestal  <i>CHANGE END PANEL(S) TO CHEMCAST \$87</i> <i>CHANGE MODESTY TO CHEMCAST \$226</i>	38	74	29	class 125 cwt 288 cu ft 31  <i>KNEESPACE: 50"</i>	<b>4,660</b>	<b>5,033</b>

top

**P** laminate top  
**W** veneer top

**muse** feet, legs and modesty holders are powder coated steel. support bar extrusion, wire management trough and pulls are anodized aluminum finish

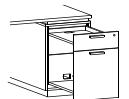

edge





to add laptop ped in any desk (min 36" deep) add \$1,162 zone 1 \ \$1,255 zone 2 list upcharge

muse

2700 series

veneer top, veneer chassis, veneer or durasyn drawer fronts  
 veneer top, veneer chassis, veneer or durasyn drawer fronts  
 laminate top, durasyn chassis, veneer or durasyn drawer fronts  
 veneer top, durasyn chassis, veneer or durasyn drawer fronts

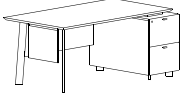
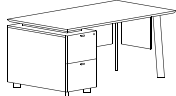
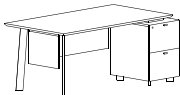
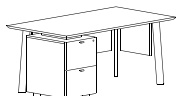
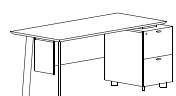
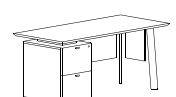
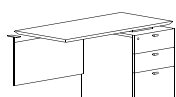

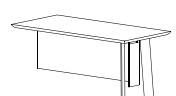
	model number	description	d w h	freight	list \$ zone 1	list \$ zone 2
	<b>D2766R</b> - _ - _ - _ - _	single pedestal desk right file/file pedestal  <i>CHANGE END PANEL(S) TO CHEMCAST \$87</i> <i>CHANGE MODESTY TO CHEMCAST \$203</i>	38 68 29  <i>KNEESPACE: 44"</i>	class 125 cwt 308 cu ft 32	<b>4,202</b>	<b>4,539</b>
	<b>D2766L</b> - _ - _ - _ - _	single pedestal desk left file/file pedestal  <i>CHANGE END PANEL(S) TO CHEMCAST \$87</i> <i>CHANGE MODESTY TO CHEMCAST \$203</i>	38 68 29  <i>KNEESPACE: 44"</i>	class 125 cwt 308 cu ft 32	<b>4,202</b>	<b>4,539</b>
	<b>D2766RL</b> - _ - _ - _ - _	single pedestal desk right file/file leg pedestal  <i>CHANGE END PANEL(S) TO CHEMCAST \$87</i> <i>CHANGE MODESTY TO CHEMCAST \$203</i>	38 68 29  <i>KNEESPACE: 44"</i>	class 125 cwt 263 cu ft 23	<b>4,248</b>	<b>4,589</b>
	<b>D2766LL</b> - _ - _ - _ - _	single pedestal desk left file/file leg pedestal  <i>CHANGE END PANEL(S) TO CHEMCAST \$87</i> <i>CHANGE MODESTY TO CHEMCAST \$203</i>	38 68 29  <i>KNEESPACE: 44"</i>	class 125 cwt 263 cu ft 23	<b>4,248</b>	<b>4,589</b>
	<b>D276630R</b> - _ - _ - _ - _	single pedestal desk right file/file pedestal  <i>CHANGE END PANEL(S) TO CHEMCAST \$87</i> <i>CHANGE MODESTY TO CHEMCAST \$203</i>	32 68 29  <i>KNEESPACE: 44"</i>	class 125 cwt 238 cu ft 28	<b>3,813</b>	<b>4,117</b>
	<b>D276630L</b> - _ - _ - _ - _	single pedestal desk left file/file pedestal  <i>CHANGE END PANEL(S) TO CHEMCAST \$87</i> <i>CHANGE MODESTY TO CHEMCAST \$203</i>	32 68 29  <i>KNEESPACE: 44"</i>	class 125 cwt 238 cu ft 28	<b>3,813</b>	<b>4,117</b>
	<b>R2748R</b> - _ - _ - _ - _	single pedestal return right box/box/file pedestal  <i>CHANGE MODESTY TO CHEMCAST \$144</i>	24 48 29  <i>KNEESPACE: 30"</i>	class 125 cwt 173 cu ft 19	<b>2,263</b>	<b>2,446</b>
	<b>R2748L</b> - _ - _ - _ - _	single pedestal return left box/box/file pedestal  <i>CHANGE MODESTY TO CHEMCAST \$144</i>	24 48 29  <i>KNEESPACE: 30"</i>	class 125 cwt 173 cu ft 19	<b>2,263</b>	<b>2,446</b>
	<b>R2748R-LN</b> - _ - _ - _	right return no pedestal legs only  <i>CHANGE END PANEL(S) TO CHEMCAST \$29</i> <i>CHANGE MODESTY TO CHEMCAST \$203</i>	23 48 29  <i>KNEESPACE: 42"</i>	class 125 cwt 100 cu ft 19	<b>1,362</b>	<b>1,473</b>

laminate  
tops only

**MB-P** mocha on birch laminate  
**NB-P** natural on birch laminate  
**CB-P** cherry on birch laminate  
**EW-P** eggshell white laminate  
**6LC-P** light cherry on birch laminate  
**7MC-P** medium cherry on birch laminate  
**8DC-P** dark cherry on birch laminate  
**2ML-P** natural maple on birch laminate  
**3ML-P** light maple on birch laminate  
**4ML-P** medium maple birch laminate  
**5ML-P** cherry maple on birch laminate

veneer  
tops only





**6LC-W** light cherry on birch veneer  
**7MC-W** medium cherry on birch veneer  
**8DC-W** dark cherry on birch veneer  
**MB-W** mocha on birch veneer  
**NB-W** natural on birch veneer  
**CB-W** cherry on birch veneer  
**2ML-W** natural maple on birch veneer  
**3ML-W** light maple on birch veneer  
**4ML-W** medium maple on birch veneer  
**5ML-W** cherry maple on birch veneer

veneer  
or  
durasyn  
chassis and  
fronts only

**MB** mocha on birch veneer  
**NB** natural on birch veneer  
**CB** cherry on birch veneer  
**6LC** light cherry on birch veneer  
**7MC** medium cherry on birch veneer  
**8DC** dark cherry on birch veneer  
**2ML** natural maple on birch veneer  
**3ML** light maple on birch veneer  
**4ML** medium maple birch veneer  
**5ML** cherry maple on birch veneer  
**EW** eggshell white durasyn

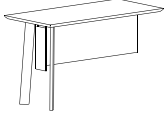
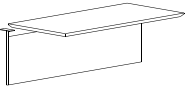
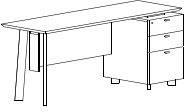
muse  
2700

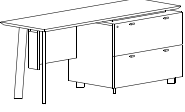
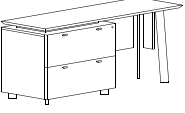
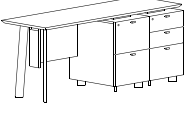

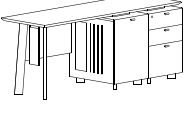
	model number	description	d	w	h	freight	list \$ zone 1	list \$ zone 2
	<b>R2748L-LN</b> - _ - _ _ - _ -	left return no pedestal legs only  <i>CHANGE END PANEL(S) TO CHEMCAST \$29</i> <i>CHANGE MODESTY TO CHEMCAST \$203</i>	23	48	29	class 125 cwt 100 cu ft 19 <i>KNEESPACE: 42"</i>	<b>1,362</b>	<b>1,473</b>
	<b>B2748</b> - _ - _ - _ _ - _ -	bridge open kneespace  <i>CHANGE MODESTY TO CHEMCAST \$277</i>	23	48	29	class 85 cwt 80 cu ft 4 <i>KNEESPACE: 48"</i>	<b>1,113</b>	<b>1,202</b>
	<b>C2772R</b> - _ - _ - _ _ - _ -	single pedestal credenza right box/box/file pedestal  <i>CHANGE END PANEL(S) TO CHEMCAST \$29</i> <i>CHANGE MODESTY TO CHEMCAST \$226</i>	24	72	29	class 125 cwt 233 cu ft 28 <i>KNEESPACE: 48"</i>	<b>3,536</b>	<b>3,819</b>
	<b>C2772L</b> - _ - _ - _ _ - _ -	single pedestal credenza left box/box/file pedestal  <i>CHANGE END PANEL(S) TO CHEMCAST \$29</i> <i>CHANGE MODESTY TO CHEMCAST \$226</i>	24	72	29	class 125 cwt 233 cu ft 28 <i>KNEESPACE: 48"</i>	<b>3,536</b>	<b>3,819</b>
	<b>C2772R-2F</b> - _ - _ - _ _ - _ -	single pedestal credenza right lateral file pedestal  <i>CHANGE END PANEL(S) TO CHEMCAST \$29</i> <i>CHANGE MODESTY TO CHEMCAST \$128</i>	24	72	29	class 125 cwt 278 cu ft 36 <i>KNEESPACE: 30"</i>	<b>3,734</b>	<b>4,032</b>
	<b>C2772L-2F</b> - _ - _ - _ _ - _ -	single pedestal credenza left lateral file pedestal  <i>CHANGE END PANEL(S) TO CHEMCAST \$29</i> <i>CHANGE MODESTY TO CHEMCAST \$128</i>	24	72	29	class 125 cwt 278 cu ft 36 <i>KNEESPACE: 30"</i>	<b>3,734</b>	<b>4,032</b>
	<b>C2772R-5D</b> - _ - _ - _ _ - _ -	single pedestal credenza right multi-file pedestal  <i>CHANGE END PANEL(S) TO CHEMCAST \$29</i> <i>CHANGE MODESTY TO CHEMCAST \$128</i>	24	72	29	class 125 cwt 313 cu ft 28 <i>KNEESPACE: 30"</i>	<b>4,699</b>	<b>5,076</b>
	<b>C2772L-5D</b> - _ - _ - _ _ - _ -	single pedestal credenza left multi-file pedestal  <i>CHANGE END PANEL(S) TO CHEMCAST \$29</i> <i>CHANGE MODESTY TO CHEMCAST \$128</i>	24	72	29	class 125 cwt 313 cu ft 28 <i>KNEESPACE: 30"</i>	<b>4,699</b>	<b>5,076</b>
	<b>C2772R-4D</b> - _ - _ - _ _ - _ -	single pedestal credenza right box/box/file cpu pedestal  <i>CHANGE END PANEL(S) TO CHEMCAST \$29</i> <i>CHANGE MODESTY TO CHEMCAST \$128</i>	24	72	29	class 125 cwt 313 cu ft 28 <i>KNEESPACE: 30"</i>	<b>4,512</b>	<b>5,003</b>

top

**P** laminate top  
**W** veneer top

**muse** feet, legs and modesty holders are powder coated steel. support bar extrusion, wire management trough and pulls are anodized aluminum finish

edge



to add laptop ped in any desk (min 36" deep) add \$1,162 zone 1 \ \$1,255 zone 2 list upcharge

muse

2700 series

veneer top, veneer chassis, veneer or durasyn drawer fronts  
 veneer top, veneer chassis, veneer or durasyn drawer fronts  
 laminate top, durasyn chassis, veneer or durasyn drawer fronts  
 veneer top, durasyn chassis, veneer or durasyn drawer fronts



**model number**  
**C2772L-4D - - -**  
 - - -

**description**  
 single pedestal credenza  
 left box/box/file cpu pedestal  
  
 CHANGE END PANEL(S) TO CHEMCAST \$29  
 CHANGE MODESTY TO CHEMCAST \$128

**d w h**  
 24 72 29  
  
 KNEESPACE: 30"

**freight**  
 class 125  
 cwt 313  
 cu ft 28

**list \$ zone 1**  
**4,512**

**list \$ zone 2**  
**5,003**

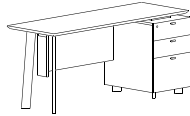

**C2766R - - - -**  
 - - -

single pedestal credenza  
 right box/box/file pedestal  
  
 CHANGE END PANEL(S) TO CHEMCAST \$29  
 CHANGE MODESTY TO CHEMCAST \$128

24 66 29  
  
 KNEESPACE: 42"

class 125  
 cwt 223  
 cu ft 18

**3,529**

**3,812**



**C2766L - - - -**  
 - - -

single pedestal credenza  
 left box/box/file pedestal  
  
 CHANGE END PANEL(S) TO CHEMCAST \$29  
 CHANGE MODESTY TO CHEMCAST \$128

24 66 29  
  
 KNEESPACE: 42"

class 125  
 cwt 223  
 cu ft 18

**3,529**

**3,812**

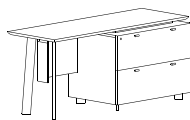

**C2766R-2F - - -**  
 - - -

single pedestal credenza  
 right lateral file pedestal  
  
 CHANGE END PANEL(S) TO CHEMCAST \$29  
 CHANGE MODESTY TO CHEMCAST \$99

24 66 29  
  
 KNEESPACE: 24"

class 125  
 cwt 278  
 cu ft 22

**3,689**

**3,984**



**C2766L-2F - - -**  
 - - -

single pedestal credenza  
 left lateral file pedestal  
  
 CHANGE END PANEL(S) TO CHEMCAST \$29  
 CHANGE MODESTY TO CHEMCAST \$99

24 66 29  
  
 KNEESPACE: 24"

class 125  
 cwt 278  
 cu ft 22

**3,689**

**3,984**

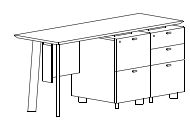

**C2766R-5D - - -**  
 - - -

single pedestal credenza  
 right multi-file pedestal  
  
 CHANGE END PANEL(S) TO CHEMCAST \$29  
 CHANGE MODESTY TO CHEMCAST \$99

24 66 29  
  
 KNEESPACE: 24"

class 125  
 cwt 308  
 cu ft 27

**4,687**

**5,061**

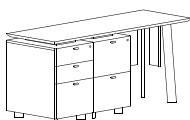

**C2766L-5D - - -**  
 - - -

single pedestal credenza  
 left multi-file pedestal  
  
 CHANGE END PANEL(S) TO CHEMCAST \$29  
 CHANGE MODESTY TO CHEMCAST \$99

24 66 29  
  
 KNEESPACE: 24"

class 125  
 cwt 308  
 cu ft 27

**4,687**

**5,061**

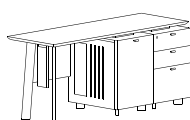

**C2766R-4D - - -**  
 - - -

single pedestal credenza  
 right box/box/file cpu pedestal  
  
 CHANGE END PANEL(S) TO CHEMCAST \$29  
 CHANGE MODESTY TO CHEMCAST \$99

24 66 29  
  
 KNEESPACE: 24"

class 125  
 cwt 308  
 cu ft 27

**4,504**

**4,864**



**C2766L-4D - - -**  
 - - -

single pedestal credenza  
 left box/box/file cpu pedestal  
  
 CHANGE END PANEL(S) TO CHEMCAST \$29  
 CHANGE MODESTY TO CHEMCAST \$99

24 66 29  
  
 KNEESPACE: 24"

class 125  
 cwt 308  
 cu ft 27

**4,504**

**4,864**

**laminate**  
 tops only

**MB-P** mocha on birch laminate  
**NB-P** natural on birch laminate  
**CB-P** cherry on birch laminate  
**EW-P** eggshell white laminate  
**6LC-P** light cherry on birch laminate  
**7MC-P** medium cherry on birch laminate  
**8DC-P** dark cherry on birch laminate  
**2ML-P** natural maple on birch laminate  
**3ML-P** light maple on birch laminate  
**4ML-P** medium maple birch laminate  
**5ML-P** cherry maple on birch laminate

**veneer**  
 tops only

**6LC-W** light cherry on birch veneer  
**7MC-W** medium cherry on birch veneer  
**8DC-W** dark cherry on birch veneer  
**MB-W** mocha on birch veneer  
**NB-W** natural on birch veneer  
**CB-W** cherry on birch veneer  
**2ML-W** natural maple on birch veneer  
**3ML-W** light maple on birch veneer  
**4ML-W** medium maple on birch veneer  
**5ML-W** cherry maple on birch veneer

**veneer**  
 or  
**durasyn**  
 chassis and  
 fronts only

**MB** mocha on birch veneer  
**NB** natural on birch veneer  
**CB** cherry on birch veneer  
**6LC** light cherry on birch veneer  
**7MC** medium cherry on birch veneer  
**8DC** dark cherry on birch veneer  
**2ML** natural maple on birch veneer  
**3ML** light maple on birch veneer  
**4ML** medium maple birch veneer  
**5ML** cherry maple on birch veneer  
**EW** eggshell white durasyn

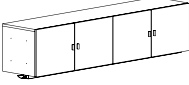
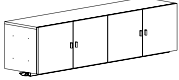
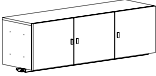
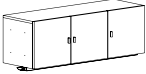
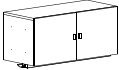
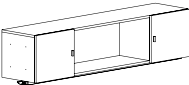
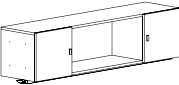
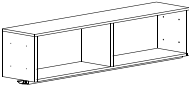
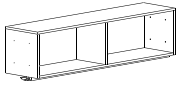
	model number	description	d	w	h	freight	list \$ zone 1	list \$ zone 2
	CHU2772 - __ - __	72" wide case hung overhead 4 wood doors  <i>CASE HUNG OVERHEAD UNITS ARE TO BE USED IN CONJUNCTION WITH CASE TOWERS, END PANELS OR HUTCHES. NOT FOR DIRECT APPLICATION TO WALLS.</i>	16	72	17	class 125 cwt 125 cu ft 16	1,598	1,726
	CHU2766 - __ - __	66" wide case hung overhead 4 wood doors  <i>CASE HUNG OVERHEAD UNITS ARE TO BE USED IN CONJUNCTION WITH CASE TOWERS, END PANELS OR HUTCHES. NOT FOR DIRECT APPLICATION TO WALLS.</i>	16	66	17	class 125 cwt 115 cu ft 15	1,401	1,513
	CHU2754 - __ - __	54" wide case hung overhead 3 wood doors  <i>CASE HUNG OVERHEAD UNITS ARE TO BE USED IN CONJUNCTION WITH CASE TOWERS, END PANELS OR HUTCHES. NOT FOR DIRECT APPLICATION TO WALLS.</i>	16	54	17	class 125 cwt 105 cu ft 14	1,177	1,271
	CHU2748 - __ - __	48" wide case hung overhead 3 wood doors  <i>CASE HUNG OVERHEAD UNITS ARE TO BE USED IN CONJUNCTION WITH CASE TOWERS, END PANELS OR HUTCHES. NOT FOR DIRECT APPLICATION TO WALLS.</i>	16	48	17	class 125 cwt 105 cu ft 14	1,065	1,151
	CHU2736 - __ - __	36" wide case hung overhead 2 wood doors  <i>CASE HUNG OVERHEAD UNITS ARE TO BE USED IN CONJUNCTION WITH CASE TOWERS, END PANELS OR HUTCHES. NOT FOR DIRECT APPLICATION TO WALLS.</i>	16	36	17	class 125 cwt 90 cu ft 12	775	838
	CHD2772 - __ - __	72" wide case hung overhead 2 wood doors open in the middle  <i>CASE HUNG OVERHEAD UNITS ARE TO BE USED IN CONJUNCTION WITH CASE TOWERS, END PANELS OR HUTCHES. NOT FOR DIRECT APPLICATION TO WALLS.</i>	16	72	17	class 125 cwt 120 cu ft 16	1,377	1,487
	CHD2766 - __ - __	66" wide case hung overhead 2 wood doors open in the middle  <i>CASE HUNG OVERHEAD UNITS ARE TO BE USED IN CONJUNCTION WITH CASE TOWERS, END PANELS OR HUTCHES. NOT FOR DIRECT APPLICATION TO WALLS.</i>	16	66	17	class 125 cwt 110 cu ft 15	1,206	1,302
	CHO2772 - __	72" wide case hung overhead open  <i>CASE HUNG OVERHEAD UNITS ARE TO BE USED IN CONJUNCTION WITH CASE TOWERS, END PANELS OR HUTCHES. NOT FOR DIRECT APPLICATION TO WALLS.</i>	15.25	72	17	class 125 cwt 115 cu ft 16	1,190	1,284
	CHO2766 - __	66" wide case hung overhead open  <i>CASE HUNG OVERHEAD UNITS ARE TO BE USED IN CONJUNCTION WITH CASE TOWERS, END PANELS OR HUTCHES. NOT FOR DIRECT APPLICATION TO WALLS.</i>	15.25	66	17	class 125 cwt 105 cu ft 15	1,026	1,108

top

**P** laminate top  
**W** veneer top

**muse** feet, legs and modesty holders are powder coated steel. support bar extrusion, wire management trough and pulls are anodized aluminum finish

edge



chemcast overhead doors in place of wood doors  
 ~ 2 doors, \$228 list upcharge  
 ~ 3-4 doors, \$360 list upcharge

muse

2700 series

veneer top, veneer chassis, veneer or durasyn drawer fronts  
 veneer top, veneer chassis, veneer or durasyn drawer fronts  
 laminate top, durasyn chassis, veneer or durasyn drawer fronts  
 veneer top, durasyn chassis, veneer or durasyn drawer fronts



	model number	description	d	w	h	freight	list \$ zone 1	list \$ zone 2
	CHO2754 - __	54" wide case hung overhead open  <small>CASE HUNG OVERHEAD UNITS ARE TO BE USED IN CONJUNCTION WITH CASE TOWERS, END PANELS OR HUTCHES. NOT FOR DIRECT APPLICATION TO WALLS.</small>	15.25	54	17	class 125 cwt 75 cu ft 10	607	656
	CHO2748 - __	48" wide case hung overhead open  <small>CASE HUNG OVERHEAD UNITS ARE TO BE USED IN CONJUNCTION WITH CASE TOWERS, END PANELS OR HUTCHES. NOT FOR DIRECT APPLICATION TO WALLS.</small>	15.25	48	17	class 125 cwt 75 cu ft 10	539	582
	CHO2736 - __	36" wide case hung overhead open  <small>CASE HUNG OVERHEAD UNITS ARE TO BE USED IN CONJUNCTION WITH CASE TOWERS, END PANELS OR HUTCHES. NOT FOR DIRECT APPLICATION TO WALLS.</small>	15.25	36	17	class 125 cwt 50 cu ft 8	403	437
	WH2766 - __ - __	66" wide wall hung overhead 4 wood doors	16	66	16	class 125 cwt 115 cu ft 13	1,792	1,935
	WH2754 - __ - __	54" wide wall hung overhead 3 wood doors	16	54	16	class 125 cwt 105 cu ft 14	1,618	1,747
	WH2748 - __ - __	48" wide wall hung overhead 3 wood doors	16	48	16	class 125 cwt 85 cu ft 10	1,541	1,665
	WH2736 - __ - __	36" wide wall hung overhead 2 wood doors	16	36	16	class 125 cwt 65 cu ft 8	1,010	1,090
	WHO2766 - __	66" wide wall hung overhead open	15.25	66	16	class 125 cwt 105 cu ft 13	1,327	1,433
	WHO2754 - __	54" wide wall hung overhead open	15.25	54	16	class 125 cwt 75 cu ft 10	1,257	1,358

laminates only

**MB-P** mocha on birch laminate  
**NB-P** natural on birch laminate  
**CB-P** cherry on birch laminate  
**EW-P** eggshell white laminate  
**6LC-P** light cherry on birch laminate  
**7MC-P** medium cherry on birch laminate  
**8DC-P** dark cherry on birch laminate  
**2ML-P** natural maple on birch laminate  
**3ML-P** light maple on birch laminate  
**4ML-P** medium maple birch laminate  
**5ML-P** cherry maple on birch laminate





veneer tops only

**6LC-W** light cherry on birch veneer  
**7MC-W** medium cherry on birch veneer  
**8DC-W** dark cherry on birch veneer  
**MB-W** mocha on birch veneer  
**NB-W** natural on birch veneer  
**CB-W** cherry on birch veneer  
**2ML-W** natural maple on birch veneer  
**3ML-W** light maple on birch veneer  
**4ML-W** medium maple on birch veneer  
**5ML-W** cherry maple on birch veneer

veneer or durasyn chassis and fronts only

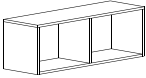
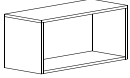
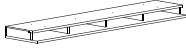
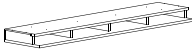
**MB** mocha on birch veneer  
**NB** natural on birch veneer  
**CB** cherry on birch veneer  
**6LC** light cherry on birch veneer  
**7MC** medium cherry on birch veneer  
**8DC** dark cherry on birch veneer  
**2ML** natural maple on birch veneer  
**3ML** light maple on birch veneer  
**4ML** medium maple birch veneer  
**5ML** cherry maple on birch veneer  
**EW** eggshell white durasyn

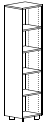
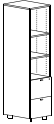
muse  
2700

	model number	description	d	w	h	freight	list \$ zone 1	list \$ zone 2
	WHO2748 - __	48" wide wall hung overhead open	15.25	48	16	class 125 cwt 70 cu ft 10	1,128	1,218
	WHO2736 - __	36" wide wall hung overhead open	15.25	36	16	class 125 cwt 50 cu ft 8	872	942
	USO72 - __ - __	72" wide underside paper organizer AVAILABLE ONLY ON CASE HUNG UNITS  <i>FACTORY INSTALLED</i>	15	72	4	class 125 cwt 15 cu ft 4	468	505
	USO66 - __ - __	66" wide underside paper organizer AVAILABLE ONLY ON CASE HUNG UNITS  <i>FACTORY INSTALLED</i>	15	66	4	class 125 cwt 15 cu ft 4	442	476
	EP2772 - __	24" d x 72" h case end panel  <i>USED TO MOUNT CASE HUNG OVERHEAD UNITS WHEN NOT USING CASE TOWER FOR SUPPORT</i>	24	1.25	72	class 125 cwt 65 cu ft 3	455	492
	CT2772-BC - __	case tower open bookcase 3 adjustable shelves 1 fixed shelf  <i>SOLID WOOD SHELVES (EACH) \$28</i> <i>EXTRA SHELF (EACH) \$92</i>	16	18	72	class 125 cwt 200 cu ft 29	1,464	1,581
	CT2772-BC2F - __ - __	case tower open bookcase above file/file below 2 adjustable shelves  <i>SOLID WOOD SHELVES (EACH) \$28</i> <i>EXTRA SHELF (EACH) \$92</i>	24	18	72	class 125 cwt 230 cu ft 29	1,940	2,095
	CT2772R-HW2F - __ - __ - __ - __	case tower right hinge door cabinet above file/file below  <i>SOLID WOOD SHELVES (EACH) \$28</i> <i>EXTRA SHELF (EACH) \$92</i>	24	18	72	class 125 cwt 240 cu ft 29	2,224	2,402
	CT2772L-HW2F - __ - __ - __ - __	case tower left hinge door cabinet above file/file below  <i>SOLID WOOD SHELVES (EACH) \$28</i> <i>EXTRA SHELF (EACH) \$92</i>	24	18	72	class 125 cwt 240 cu ft 29	2,224	2,402

top

**P** laminate top  
**W** veneer top

**muse** feet, legs and modesty holders are powder coated steel. support bar extrusion, wire management trough and pulls are anodized aluminum finish

edge





muse

2700 series

veneer top, veneer chassis, veneer or durasyn drawer fronts  
 veneer top, veneer chassis, veneer or durasyn drawer fronts  
 laminate top, durasyn chassis, veneer or durasyn drawer fronts  
 veneer top, durasyn chassis, veneer or durasyn drawer fronts

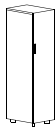
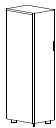
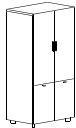
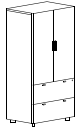
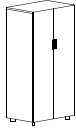
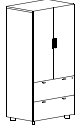
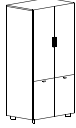
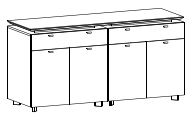

	model number	description	d	w	h	freight	list \$ zone 1	list \$ zone 2
	<b>CT2772R-WD</b> - _ - _ - _	case tower right hinge wardrobe with coat storage  <i>SOLID WOOD SHELVES (EACH) \$28</i> <i>EXTRA SHELF (EACH) \$92</i>	24	18	72	class 125 cwt 200 cu ft 29	<b>1,822</b>	<b>1,966</b>
	<b>CT2772L-WD</b> - _ - _ - _	case tower left hinge wardrobe with coat storage  <i>SOLID WOOD SHELVES (EACH) \$28</i> <i>EXTRA SHELF (EACH) \$92</i>	24	18	72	class 125 cwt 200 cu ft 29	<b>1,822</b>	<b>1,966</b>
	<b>CT2772-HWHW</b> - _ - _ - _	case tower hinge doors above with 2 adjustable shelves 1 fixed shelf hinge doors below with 1 adjustable shelf  <i>SOLID WOOD SHELVES (EACH) \$28</i> <i>EXTRA SHELF (EACH) \$92</i>	24	36	72	class 125 cwt 285 cu ft 42	<b>2,886</b>	<b>3,117</b>
	<b>CT2772-HW2F</b> - _ - _ - _	case tower hinge doors above lateral file below  <i>SOLID WOOD SHELVES (EACH) \$28</i> <i>EXTRA SHELF (EACH) \$92</i>	24	36	72	class 125 cwt 285 cu ft 42	<b>3,079</b>	<b>3,325</b>
	<b>CT2772-WD</b> - _ - _ - _	case tower wardrobe right side coat storage left side 3 adjustable shelves storage shelf above  <i>SOLID WOOD SHELVES (EACH) \$28</i> <i>EXTRA SHELF (EACH) \$92</i>	24	36	72	class 125 cwt 285 cu ft 42	<b>2,799</b>	<b>3,022</b>
	<b>CT2772-AV2F</b> - _ - _ - _	case tower av access hinge doors above lateral file below	24	36	72	class 125 cwt 310 cu ft 42	<b>3,477</b>	<b>3,756</b>
	<b>CT2772-AVHW</b> - _ - _ - _	case tower av access hinge doors above hinge doors below  <i>SOLID WOOD SHELVES (EACH) \$28</i> <i>EXTRA SHELF (EACH) \$92</i>	24	36	72	class 125 cwt 310 cu ft 42	<b>3,283</b>	<b>3,426</b>
	<b>4HW2774D-36</b> - _ - _ - _	serving height credenza 2 sets of hinged doors with 1 adjustable shelf on each side 2 drawers above  <i>SOLID WOOD SHELVES (EACH) \$28</i> <i>EXTRA SHELF (EACH) \$92</i>	20	72	36	class 125 cwt 310 cu ft 42	<b>5,755</b>	<b>6,215</b>
	<b>4FD2736</b> - _ - _ - _ - _	lateral file 4 drawer standard with anti-tip locking mechanism	20	36	56	class 125 cwt 265 cu ft 29	<b>2,725</b>	<b>2,943</b>

laminates  
tops only

**MB-P** mocha on birch laminate  
**NB-P** natural on birch laminate  
**CB-P** cherry on birch laminate  
**EW-P** eggshell white laminate  
**6LC-P** light cherry on birch laminate  
**7MC-P** medium cherry on birch laminate  
**8DC-P** dark cherry on birch laminate  
**2ML-P** natural maple on birch laminate  
**3ML-P** light maple on birch laminate  
**4ML-P** medium maple birch laminate  
**5ML-P** cherry maple on birch laminate



veneer  
tops only

**6LC-W** light cherry on birch veneer  
**7MC-W** medium cherry on birch veneer  
**8DC-W** dark cherry on birch veneer  
**MB-W** mocha on birch veneer  
**NB-W** natural on birch veneer  
**CB-W** cherry on birch veneer  
**2ML-W** natural maple on birch veneer  
**3ML-W** light maple on birch veneer  
**4ML-W** medium maple on birch veneer  
**5ML-W** cherry maple on birch veneer

veneer  
or  
durasyn  
chassis and  
fronts only

**MB** mocha on birch veneer  
**NB** natural on birch veneer  
**CB** cherry on birch veneer  
**6LC** light cherry on birch veneer  
**7MC** medium cherry on birch veneer  
**8DC** dark cherry on birch veneer  
**2ML** natural maple on birch veneer  
**3ML** light maple on birch veneer  
**4ML** medium maple birch veneer  
**5ML** cherry maple on birch veneer  
**EW** eggshell white durasyn

muse  
2700

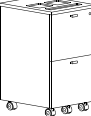
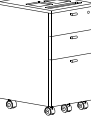
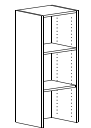
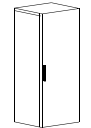
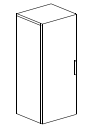
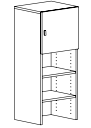
	model number	description	d	w	h	freight	list \$ zone 1	list \$ zone 2
	3FD2736 - _ - _ - _ - _ -	lateral file 3 drawer standard with anti-tip locking mechanism	20	36	29	class 125 cwt 175 cu ft 17	2,682	2,896
	2FD2736 - _ - _ - _ - _ -	lateral file 2 drawer standard with anti-tip locking mechanism	20	36	29	class 125 cwt 175 cu ft 17	1,945	2,101
	HD2736 - _ - _ - _ - _ -	hinge door cabinet	24	36	29	class 125 cwt 175 cu ft 17	1,826	1,971
	MP272F - _ - _ -	mobile pedestal file/file black organizer top	18.9	15.6	27.3	class 125 cwt 80 cu ft 7	1,217	1,315
	MP273D - _ - _ -	mobile pedestal box/box/file black organizer top	18.9	15.6	27.3	class 125 cwt 80 cu ft 7	1,232	1,331
	HO2718 - _ -	hutch open 2 adjustable shelves  <i>EXTRA SHELF (EACH) \$92</i>	16	18	43	class 125 cwt 60 cu ft 10	669	721
	HW2718R - _ - _ -	hutch solid wood door right hinge	16	18	43	class 125 cwt 80 cu ft 10	868	936
	HW2718L - _ - _ -	hutch solid wood door left hinge	16	18	43	class 125 cwt 80 cu ft 10	868	936
	HWO2718R - _ - _ -	hutch wood door above open below right hinge 2 adjustable shelves  <i>EXTRA SHELF (EACH) \$92</i>	16	18	43	class 125 cwt 70 cu ft 10	795	859

top

**P** laminate top  
**W** veneer top

**muse**

feet, legs and modesty holders are powder coated steel. support bar extrusion, wire management trough and pulls are anodized aluminum finish

for standard fabrics available on tack boards, see page 424-426. Fabrics on inwood fabric card approved for tack boards. For any other fabrics, they must be approved. **Please call customer service for info.**

edge





muse

2700 series

veneer top, veneer chassis, veneer or durasyn drawer fronts  
 veneer top, veneer chassis, veneer or durasyn drawer fronts  
 laminate top, durasyn chassis, veneer or durasyn drawer fronts  
 veneer top, durasyn chassis, veneer or durasyn drawer fronts

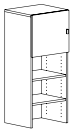
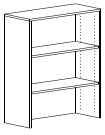
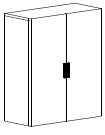

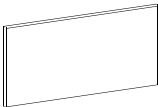
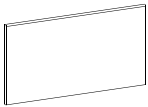
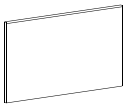
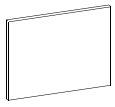
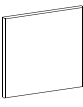
	model number	description	d	w	h	freight	list \$ zone 1	list \$ zone 2
	HWO2718L - _ - _	hutch wood door above open below left hinge 2 adjustable shelves  <i>EXTRA SHELF (EACH) \$92</i>	16	18	43	class 125 cwt 70 cu ft 10	795	859
	HO2736 - _	hutch open 2 adjustable shelves  <i>SOLID WOOD SHELVES (EACH) \$28</i> <i>EXTRA SHELF (EACH) \$92</i>	15.25	36	43	class 125 cwt 100 cu ft 19	783	846
	HWO2736 - _ - _ - _ - _	hutch 2 solid wood doors  <i>SOLID WOOD SHELVES (EACH) \$28</i> <i>EXTRA SHELF (EACH) \$92</i>	16	36	43	class 125 cwt 120 cu ft 19	1,252	1,352
	HWO2736 - _ - _ - _ - _	hutch 2 solid wood doors above open below 2 adjustable shelves  <i>SOLID WOOD SHELVES (EACH) \$28</i> <i>EXTRA SHELF (EACH) \$92</i>	16	36	43	class 125 cwt 130 cu ft 19	1,038	1,120
	TP2772 - _	tack panel USED WITH CASE HUNG OVERHEAD UNITS requires 2.25 yards	.5	73.5	30	class 125 cwt 35 cu ft 4	388 396 416 425 439 450 460	416 426 450 459 474 486 498
	TP2766 - _	tack panel USED WITH CASE HUNG OVERHEAD UNITS requires 2 yards	.5	67.5	30	class 125 cwt 32 cu ft 3	367 372 390 397 407 416 424	396 402 421 427 440 449 458
	TP2754 - _	tack panel USED WITH CASE HUNG OVERHEAD UNITS requires 2 yards	.5	55.5	30	class 125 cwt 27 cu ft 2	292 296 312 319 328 338 346	314 320 338 345 355 364 372
	TP2748 - _	tack panel USED WITH CASE HUNG OVERHEAD UNITS requires 1.5 yards	.5	49.5	30	class 125 cwt 24 cu ft 2	258 264 277 284 293 299 307	279 285 299 306 316 323 330
	TP2736 - _	tack panel USED WITH CASE HUNG OVERHEAD UNITS requires 1.25 yards	.5	37.5	30	class 125 cwt 19 cu ft 2	194 195 197 208 219 223 231	209 211 213 226 237 243 248

laminates  
tops only

**MB-P** mocha on birch laminate  
**NB-P** natural on birch laminate  
**CB-P** cherry on birch laminate  
**EW-P** eggshell white laminate  
**6LC-P** light cherry on birch laminate  
**7MC-P** medium cherry on birch laminate  
**8DC-P** dark cherry on birch laminate  
**2ML-P** natural maple on birch laminate  
**3ML-P** light maple on birch laminate  
**4ML-P** medium maple birch laminate  
**5ML-P** cherry maple on birch laminate

veneer  
tops only







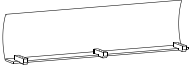

**6LC-W** light cherry on birch veneer  
**7MC-W** medium cherry on birch veneer  
**8DC-W** dark cherry on birch veneer  
**MB-W** mocha on birch veneer  
**NB-W** natural on birch veneer  
**CB-W** cherry on birch veneer  
**2ML-W** natural maple on birch veneer  
**3ML-W** light maple on birch veneer  
**4ML-W** medium maple on birch veneer  
**5ML-W** cherry maple on birch veneer

veneer  
or  
durasyn  
chassis and  
fronts only

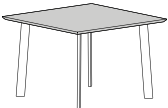
**MB** mocha on birch veneer  
**NB** natural on birch veneer  
**CB** cherry on birch veneer  
**6LC** light cherry on birch veneer  
**7MC** medium cherry on birch veneer  
**8DC** dark cherry on birch veneer  
**2ML** natural maple on birch veneer  
**3ML** light maple on birch veneer  
**4ML** medium maple birch veneer  
**5ML** cherry maple on birch veneer  
**EW** eggshell white durasyn

muse  
2700

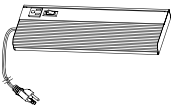

	model number	description	d	w	h	freight	list \$ zone 1	list \$ zone 2
	<b>WS2742</b>	42" wide wire management screen standard translucent white finish		42		class cwt cu ft	<b>582</b>	<b>629</b>
	<b>SA42 - _ - _</b>	42" square table top veneer with shaped edges TO MATCH MUSE CASEGOODS; LEGS PURCHASED SEPARATELY	42 legs	42	29 w/	class 125 cwt 60 cu ft 4	<b>455</b>	<b>492</b>
	<b>SK42 - _ - _</b>	42" square table top laminate with shaped edges TO MATCH MUSE CASEGOODS; LEGS PURCHASED SEPARATELY	42 legs	42	29 w/	class 125 cwt 50 cu ft 4	<b>254</b>	<b>273</b>
	<b>CA36 - _ - _</b>	36" round table top veneer with shaped edges TO MATCH MUSE CASEGOODS; LEGS PURCHASED SEPARATELY  <i>TO ADD CASTERS \$77</i>	36 legs	36	29 w/	class 125 cwt 45 cu ft 4	<b>494</b>	<b>534</b>
	<b>CK36 - _ - _</b>	36" round table top laminate with shaped edges TO MATCH MUSE CASEGOODS; LEGS PURCHASED SEPARATELY  <i>TO ADD CASTERS \$77</i>	36 legs	36	29 w/	class 125 cwt 45 cu ft 4	<b>344</b>	<b>371</b>
	<b>CA42 - _ - _</b>	42" round table top veneer with shaped edges TO MATCH MUSE CASEGOODS; LEGS PURCHASED SEPARATELY  <i>TO ADD CASTERS \$102</i>	42 legs	42	29 w/	class 125 cwt 50 cu ft 4	<b>581</b>	<b>629</b>
	<b>CK42 - _ - _</b>	42" round table top laminate with shaped edges TO MATCH MUSE CASEGOODS; LEGS PURCHASED SEPARATELY  <i>TO ADD CASTERS \$102</i>	42 legs	42	29 w/	class 125 cwt 50 cu ft 4	<b>379</b>	<b>408</b>
	<b>27DL</b>	desk leg for muse tables standard powder coated steel stardust finish height with casters 29"  <i>TO ADD CASTERS \$26</i>	3	1	28	class 125 cwt 10 cu ft 1	<b>325</b>	<b>352</b>
	<b>TL24</b>	task light for use with overhead storage units  <i>FIELD INSTALLED ONLY</i>	7	24	2	class 100 cwt 11 cu ft 1	<b>335</b>	<b>364</b>

top

**P** laminate top  
**W** veneer top

**muse** feet, legs and modesty holders are powder coated steel. support bar extrusion, wire management trough and pulls are anodized aluminum finish

edge









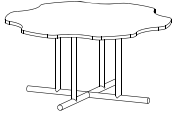

muse

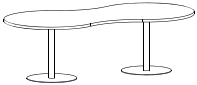
2700 series

veneer top, veneer chassis, veneer or durasyn drawer fronts  
 veneer top, veneer chassis, veneer or durasyn drawer fronts  
 laminate top, durasyn chassis, veneer or durasyn drawer fronts  
 veneer top, durasyn chassis, veneer or durasyn drawer fronts

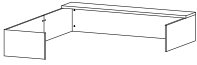
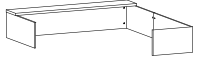

	model number	description	d	w	h	freight	list \$ zone 1	list \$ zone 2
	<b>FLS60</b> <b>CX48</b> 2 ea for above top	flower top laminated top/shelf edge  x style base 2" diameter steel color; black 4 columns upright	60 dia			class 125 cwt 120 cu ft	<b>1,766</b>  as shown	<b>1,907</b>
	<b>WW9648</b> <b>PDB20</b> 2 ea for above top	wedge top laminated top/wood edge  post disc base color; stardust or black 2 ea. for above top	96	46		class 125 cwt 185 cu ft	<b>4,012</b>  as shown	<b>4,324</b>
	<b>PP9646</b> <b>PDB20</b> 2 ea for above top	peanut top laminated top/pvc edge  post disc base color; stardust or black 2 ea. for above top	96	46		class 125 cwt 180 cu ft	<b>3,160</b>  as shown	<b>3,412</b>
	<b>TD2772 - _</b>	desk top transaction counter for use with 72" unit only	12	72	15.25	class 100 cwt 8 cu ft 125	<b>882 W</b>  <b>882 P</b>	<b>953 W</b>  <b>953 P</b>
	<b>TD2766 - _</b>	desk top transaction counter for use with 66" unit only	12	66	15.25	class 125 cwt 84 cu ft 6	<b>882 W</b>  <b>882 P</b>	<b>953 W</b>  <b>953 P</b>
	<b>TD276630 - _</b>	desk top transaction counter for use with 30" x 66" desk unit only	12	66	15.25	class 125 cwt 84 cu ft 6	<b>882 W</b>  <b>882 P</b>	<b>953 W</b>  <b>953 P</b>
	<b>TM2772L - _</b>	desk top transaction/reception gallery for use with executive 72" L unit	12	72	15.25	class 125 cwt 100 cu ft 8	<b>1,310 W</b>  <b>1,310 P</b>	<b>1,415 W</b>  <b>1,415 P</b>
	<b>TM2772R - _</b>	desk top transaction/reception gallery for use with executive 72" L unit	12	72	15.25	class 100 cwt 8 cu ft 125	<b>1,310 W</b>  <b>1,310 P</b>	<b>1,415 W</b>  <b>1,415 P</b>
	<b>TM2766L - _</b>	desk top transaction/reception gallery for use with executive 66" L unit	12	66	15.25	class 125 cwt 100 cu ft 8	<b>1,310 W</b>  <b>1,310 P</b>	<b>1,415 W</b>  <b>1,415 P</b>

laminated tops only

**MB-P** mocha on birch laminate  
**NB-P** natural on birch laminate  
**CB-P** cherry on birch laminate  
**EW-P** eggshell white laminate  
**6LC-P** light cherry on birch laminate  
**7MC-P** medium cherry on birch laminate  
**8DC-P** dark cherry on birch laminate  
**2ML-P** natural maple on birch laminate  
**3ML-P** light maple on birch laminate  
**4ML-P** medium maple birch laminate  
**5ML-P** cherry maple on birch laminate





veneer tops only

**6LC-W** light cherry on birch veneer  
**7MC-W** medium cherry on birch veneer  
**8DC-W** dark cherry on birch veneer  
**MB-W** mocha on birch veneer  
**NB-W** natural on birch veneer  
**CB-W** cherry on birch veneer  
**2ML-W** natural maple on birch veneer  
**3ML-W** light maple on birch veneer  
**4ML-W** medium maple on birch veneer  
**5ML-W** cherry maple on birch veneer

veneer or durasyn chassis and fronts only

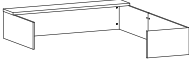
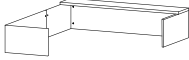
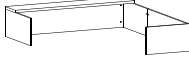
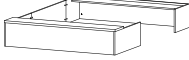
**MB** mocha on birch veneer  
**NB** natural on birch veneer  
**CB** cherry on birch veneer  
**6LC** light cherry on birch veneer  
**7MC** medium cherry on birch veneer  
**8DC** dark cherry on birch veneer  
**2ML** natural maple on birch veneer  
**3ML** light maple on birch veneer  
**4ML** medium maple birch veneer  
**5ML** cherry maple on birch veneer  
**EW** eggshell white durasyn

muse  
2700

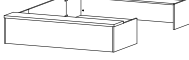
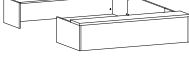
	model number	description	d	w	h	freight	list \$ zone 1	list \$ zone 2
	TM2766R - __	desk top transaction/reception gallery for use with executive 66" L unit	12	66	15.25	class 125 cwt 100 cu ft 8	1,310 W  1,310 P	1,415 W  1,415 P
	TM276630L - __	desk top transaction/reception gallery for use with executive 30" x 66" L unit	12	66	15.25	class 125 cwt 100 cu ft 8	1,310 W  1,310 P	1,415 W  1,415 P
	TM276630R - __	desk top transaction/reception gallery for use with executive 30" x 66" L unit	12	66	15.25	class 125 cwt 100 cu ft 8	1,310 W  1,310 P	1,415 W  1,415 P
	TU2772R - __	desk top transaction/reception gallery for use with executive 72" U unit	12	72	15.25	class 125 cwt 140 cu ft 10	1,756 W  1,756 P	1,898 W  1,898 P
	TU2772L - __	desk top transaction/reception gallery for use with executive 72" U unit	12	72	15.25	class 125 cwt 140 cu ft 10	1,756 W  1,756 P	1,898 W  1,898 P
	TU2766R - __	desk top transaction/reception gallery for use with 66" U unit	12	66	15.25	class 125 cwt 140 cu ft 10	1,310 W  1,310 P	1,415 W  1,415 P
	TU2766L - __	desk top transaction/reception gallery for use with 66" U unit	12	66	15.25	class 125 cwt 140 cu ft 10	1,310 W  1,310 P	1,415 W  1,415 P
	TU276630R - __	desk top transaction/reception gallery for use with 30" x 66" U unit	12	66	15.25	class 125 cwt 140 cu ft 10	1,756 W  1,756 P	1,898 W  1,898 P
	TU276630L - __	desk top transaction/reception gallery for use with 30" x 66" U unit	12	66	15.25	class 125 cwt 140 cu ft 10	1,756 W  1,756 P	1,898 W  1,898 P

top

**P** laminate top  
**W** veneer top

**muse**

feet, legs and modesty holders are powder coated steel. support bar extrusion, wire management trough and pulls are anodized aluminum finish

edge





# inwood

OFFICE  
ENVIRONMENTS

## price list

effective 01 january 2012

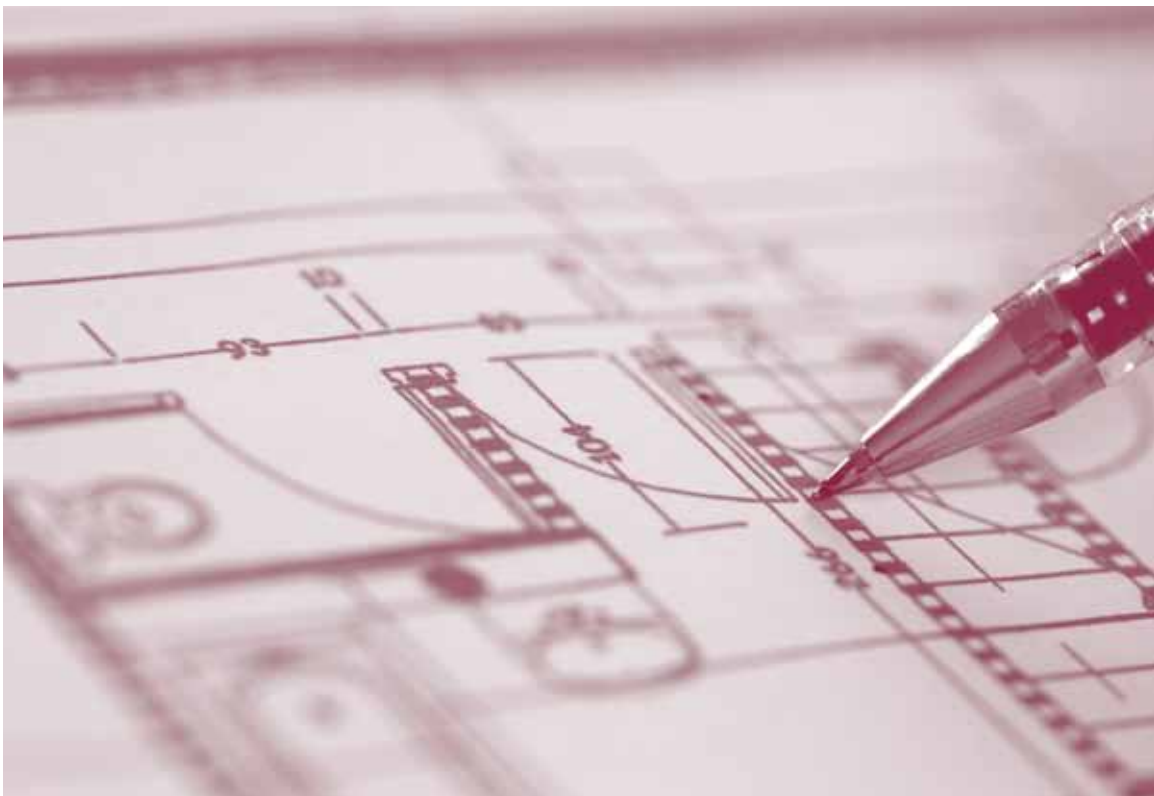

account # \_\_\_\_\_  
discount \_\_\_\_\_  
zone \_\_\_\_\_  
c.s.r. \_\_\_\_\_  
sales rep. \_\_\_\_\_

## saleer

3000/3100/3200

[click here for warranty  
and terms information](#)

zones one and two



# inwood

OFFICE  
ENVIRONMENTS

---



saleer  
3000/3100/3200

### saleer 3200/3100/3000 series specifications

#### materials:

All wood is thoroughly air and kiln dried to a moisture content not to exceed 8% at the time of assembly.

#### veneers:

All exposed surfaces are plain sliced Maple. Veneers are carefully slip-matched and balanced. All drawer fronts, doors, end panels, and modesty panels are vertical grain.

#### top work surfaces:

- **wood veneer tops** are 1 1/4" thick, 3-ply construction with self-edge; consisting of a 1/40" thick Maple veneer work surface, Gator-ply backing and the core material is 45lb density flake board.
- **lamine tops** are 1 1/4" thick, 3-ply construction with self-edge; consisting of a high pressure laminate work surface, Gator-ply backing and the core material is 45ld density flake board.

#### construction:

Uses a mortise & tenon and glue to join panels and modesty panels. All joints are reinforced with glue. All bookcase shelves are standard 3/4" thick.

#### drawers:

Drawer fronts are 3/4" thick, 3-ply construction with vertical slip matched veneer. Drawer edges are veneered on top and sides with matching wood veneers. All drawer sides and backs are plywood, dovetailed front and back with 3-ply drawer bottoms. Drawer bottoms are framed on four sides and stapled from the bottom side. Drawer interiors are finished with a clear coat sealer to prevent swelling or shrinkage. Box drawers have a high grade Sterling metal ball-bearing drawer suspension. File drawers have a high grade Sterling metal ball bearing full progressive suspension and are equipped with a filing frame to accommodate hanging file folders. All drawers have smooth quiet operation.

#### locking:

Each drawer cabinet has its own lock. Each unit is equipped with two keys. Units may be keyed alike in groups (per office, if requested) for an additional charge of \$35 list per unit.

#### finish:

All Inwood finishes are catalyzed varnish finish. Our multi-step satin finishes leave an open grain natural look to the furniture.

#### pulls/grommets:

Pulls are standard in silver. Optional in black..



standard silver pull



BP- black pull



**30" deep pedestals**

letter  
front to back

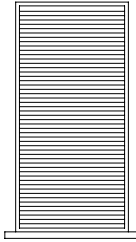

letter  
side to side

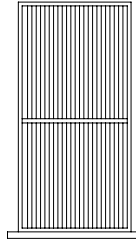

1 row legal  
front to back  
1 row letter  
side to side

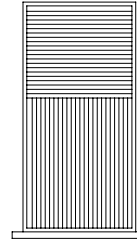

**24" deep pedestals**

letter  
front to back

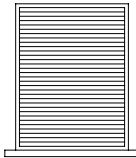

legal  
side to side

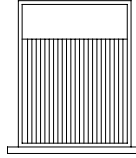

**36" lateral files**

letter front to back

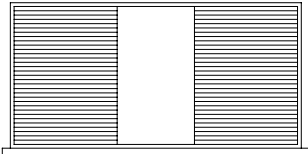

letter side to side

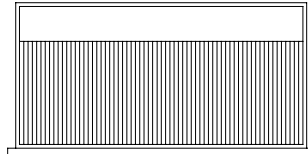

legal front to back

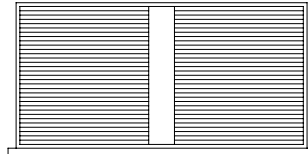

legal side to side

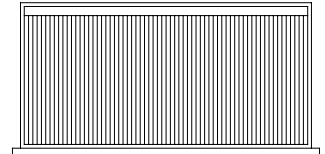

**30" lateral files**

letter front to back

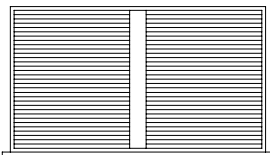

letter side to side

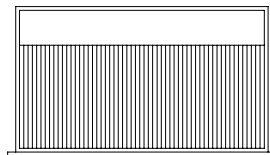



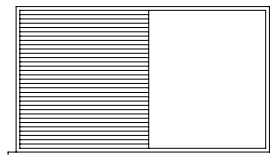

legal front to back

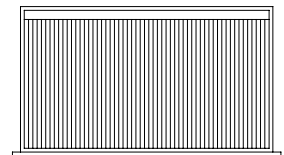

legal side to side





top size	description	model number	d	w	h	freight	veneer top SELF EDGE <b>VS</b> <small>TOP AND EDGE COLOR HAVE SAME FINISH</small>		laminate top SELFEDGE <b>LS</b> <small>SPECIFY BOTH TOP AND EDGE COLOR</small>	
							list \$ zone 1	zone 2	list \$ zone 1	zone 2
	rectangular top 24" x 36"	30-2430T - __ - __	36	24	1.25	cwt 40 cu ft 2 class 70	631	682	139	152
		30-2442T - __ - __	42	24	1.25	cwt 45 cu ft 2 class 70	691	746	158	171
		30-2448T - __ - __	48	24	1.25	cwt 50 cu ft 2 class 70	696	753	175	189
		30-2454T - __ - __	54	24	1.25	cwt 60 cu ft 2 class 70	753	811	190	205
		30-2466T - __ - __	66	24	1.25	cwt 70 cu ft 3 class 70	835	903	262	285
		30-2460T - __ - __	60	24	1.25	cwt 65 cu ft 3 class 70	792	856	206	225
		30-2472T - __ - __	72	24	1.25	cwt 75 cu ft 3 class 70	981	1,058	275	295
		30-2478T - __ - __	78	24	1.25	cwt 80 cu ft 3 class 70	1,396	1,508	297	322
30-2484T - __ - __	84	24	1.25	cwt 85 cu ft 3 class 70	1,396	1,508	316	340		
	rectangular top 30" x 48"	30-3048T - __ - __	48	30	1.25	cwt 80 cu ft 3 class 70	931	1,005	252	269
		30-3054T - __ - __	54	30	1.25	cwt 85 cu ft 3 class 70	936	1,010	326	353
		30-3060T - __ - __	60	30	1.25	cwt 90 cu ft 3 class 70	997	1,077	347	374
		30-3066T - __ - __	66	30	1.25	cwt 95 cu ft 3 class 70	1,054	1,137	367	397
		30-3072T - __ - __	72	30	1.25	cwt 100 cu ft 3 class 70	1,154	1,208	389	420
		30-3078T - __ - __	78	30	1.25	cwt 105 cu ft 4 class 70	1,445	1,560	443	476
		30-3084T - __ - __	84	30	1.25	cwt 110 cu ft 4 class 70	1,557	1,681	703	759
	rectangular top 36" x 48"	30-3648T - __ - __	48	36	1.25	cwt 85 cu ft 3 class 70	1,245	1,344	295	320
		30-3654T - __ - __	54	36	1.25	cwt 90 cu ft 3 class 70	1,259	1,361	347	374
		30-3660T - __ - __	60	36	1.25	cwt 95 cu ft 4 class 70	1,275	1,378	388	418
		30-3666T - __ - __	66	36	1.25	cwt 100 cu ft 4 class 70	1,343	1,450	408	441
		30-3672T - __ - __	72	36	1.25	cwt 105 cu ft 4 class 70	1,620	1,749	601	651
		30-3678T - __ - __	78	36	1.25	cwt 110 cu ft 4 class 70	-	-	727	784
		30-3684T - __ - __	84	36	1.25	cwt 115 cu ft 4 class 70	-	-	743	802
		30-3690T - __ - __	90	36	1.25	cwt 120 cu ft 4 class 70	-	-	757	818
		30-3696T - __ - __	96	36	1.25	cwt 125 cu ft 5 class 70	-	-	772	833
	rectangular top 48" x 66"	30-4866T - __ - __	66	48	1.25	cwt 125 cu ft 14 class 70	2,799	3,023	1,086	1,169
		30-4872T - __ - __	72	48	1.25	cwt 140 cu ft 16 class 70	2,799	3,023	1,086	1,169
		30-4884T - __ - __	84	48	1.25	cwt 165 cu ft 18 class 70	2,799	3,023	1,086	1,169
		30-4896T - __ - __	96	48	1.25	cwt 185 cu ft 21 class 70	3,091	3,318	1,378	1,461

top

**L** laminate top  
**V** veneer top

wood top  
finishes

**2ML-W** Natural maple  
**3ML-W** Light maple  
**4ML-W** Medium maple  
**5ML-W** Cherry maple  
**1CM-W** Coffee on maple





**2UM-W** Umber on maple  
**3SM-W** Shadow on maple



top shape	description	model number	d	w	h	freight	veneer top SELF EDGE <b>VS</b> <small>TOP AND EDGE COLOR HAVE SAME FINISH</small>		laminate top SELFEDGE <b>LS</b> <small>SPECIFY BOTH TOP AND EDGE COLOR</small>	
							list \$ zone 1	zone 2	list \$ zone 1	zone 2
	D shaped bullet top 24" x __	30-2460DT - __ - __	60	24	1.25	cwt 65 cu ft 3 class 70	1,900	2,054	453	491
		30-2455DT - __ - __	66	24	1.25	cwt 70 cu ft 3 class 70	1,994	2,154	491	528
		30-2472DT - __ - __	72	24	1.25	cwt 75 cu ft 3 class 70	2,300	2,485	527	569
	D shaped bullet top 30" x __	30-3060DT - __ - __	60	30	1.25	cwt 95 cu ft 3 class 70	1,054	1,137	556	600
		30-3066DT - __ - __	66	30	1.25	cwt 95 cu ft 3 class 70	1,054	1,208	624	675
		30-3072DT - __ - __	72	30	1.25	cwt 100 cu ft 3 class 70	1,445	1,560	643	695
		30-3078DT - __ - __	78	30	1.25	cwt 105 cu ft 3 class 70	-	-	660	716
		30-3084DT - __ - __	84	30	1.25	cwt 110 cu ft 4 class 70	-	-	824	889
		30-3090DT - __ - __	90	30	1.25	cwt 115 cu ft 4 class 70	-	-	843	909
		30-3096DT - __ - __	96	30	1.25	cwt 120 cu ft 4 class 70	-	-	862	932
	D shaped bullet top 36" x __	30-3666DT - __ - __	66	36	1.25	cwt 100 cu ft 4 class 70	2,547	2,751	579	625
		30-3672DT - __ - __	72	36	1.25	cwt 105 cu ft 4 class 70	2,680	2,893	704	761
		30-3678DT - __ - __	78	36	1.25	cwt 110 cu ft 4 class 70	-	-	1,022	1,101
		30-3684DT - __ - __	84	36	1.25	cwt 115 cu ft 4 class 70	-	-	1,147	1,240
		30-3690DT - __ - __	90	36	1.25	cwt 120 cu ft 4 class 70	-	-	1,275	1,375
		30-3696DT - __ - __	96	36	1.25	cwt 125 cu ft 4 class 70	-	-	1,403	1,508
	bow shaped top 36" at center x __	30-3672BT - __ - __	72	36	1.25	cwt 110 cu ft 4 class 70	2,547	2,751	1,022	1,101
		30-3678BT - __ - __	78	36	1.25	cwt 115 cu ft 4 class 70	-	-	1,147	1,240
	bow shaped top 42" at center x __	30-4272BT - __ - __	72	42	1.25	cwt 105 cu ft 4 class 70	2,766	2,989	712	769
	P shaped top 36" x __ (RIGHT) "P" IS 42" IN DIA	30-3672PTR - __ - __	72	36	1.25	cwt 115 cu ft 4 class 70	3,183	3,438	1,457	1,575
		30-3678PTR - __ - __	78	36	1.25	cwt 125 cu ft 4 class 70	3,183	3,438	1,478	1,596
		30-3684PTR - __ - __	84	36	1.25	cwt 135 cu ft 4 class 70	3,183	3,438	1,597	1,726
		30-3690PTR - __ - __	90	36	1.25	cwt 145 cu ft 4 class 70	-	-	1,616	1,725
		30-3696PTR - __ - __	96	36	1.25	cwt 155 cu ft 4 class 70	-	-	1,634	1,765
	P shaped top 36" x __ (LEFT) "P" IS 42" IN DIAMETER	30-3672PTL - __ - __	72	36	1.25	cwt 115 cu ft 4 class 70	3,183	3,438	1,457	1,575
		30-3678PTL - __ - __	78	36	1.25	cwt 125 cu ft 5 class 70	3,183	3,438	1,478	1,596
		30-3684PTL - __ - __	84	36	1.25	cwt 135 cu ft 5 class 70	3,183	3,438	1,597	1,756
		30-3690PTL - __ - __	90	36	1.25	cwt 145 cu ft 5 class 70	-	-	1,616	1,725
		30-3696PTL - __ - __	96	36	1.25	cwt 155 cu ft 5 class 70	-	-	1,634	1,765

saleer 3000/3100/3200

laminates  
 2ML-P Natural maple  
 3ML-P Light maple  
 4ML-P Medium maple  
 5ML-P Cherry maple  
 1CM-P Coffee on maple  
 2UM-P Umber on maple  
 3SM-P Shadow on maple

top shape	description	model number	d	w	h	freight	veneer top SELF EDGE <b>VS</b> <small>TOP AND EDGE COLOR HAVE SAME FINISH</small>				laminate top SELFEDGE <b>LS</b> <small>SPECIFY BOTH TOP AND EDGE COLOR</small>			
							list \$ zone 1	zone 2	list \$ zone 1	zone 2	list \$ zone 1	zone 2	list \$ zone 1	zone 2
	bow return top 30" x __ (RIGHT)	30-3066BTR - __ - __	66	30	1.25	cwt 100 cu ft 4 class 70	1,346	1,429	659	713				
		30-3072BTR - __ - __	72	36	1.25	cwt 105 cu ft 4 class 70	1,912	2,041	893	943				
	bow return top 30" x __ (LEFT)	30-3066BTL - __ - __	66	30	1.25	cwt 100 cu ft 4 class 70	1,346	1,429	659	713				
		30-3072BTL - __ - __	72	36	1.25	cwt 105 cu ft 4 class 70	1,912	2,041	893	943				
	bow return top 36" x __ (RIGHT)	30-3666BTR - __ - __	66	36	1.25	cwt 110 cu ft 4 class 70	1,635	1,742	699	757				
		30-3672BTR - __ - __	72	36	1.25	cwt 115 cu ft 4 class 70	1,912	2,041	893	943				
	bow return top 36" x __ (LEFT)	30-3666BTL - __ - __	66	36	1.25	cwt 110 cu ft 4 class 70	1,635	1,742	699	757				
		30-3672BTL - __ - __	72	36	1.25	cwt 115 cu ft 4 class 70	1,912	2,041	893	943				

top



**L** laminate top  
**V** veneer top

wood top  
finishes

**2ML-W** Natural maple  
**3ML-W** Light maple  
**4ML-W** Medium maple  
**5ML-W** Cherry maple  
**1CM-W** Coffee on maple

**2UM-W** Umber on maple  
**3SM-W** Shadow on maple

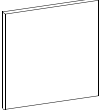
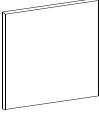
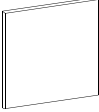
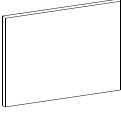

	model number	description	d	w	h	freight	list \$ zone 1	list \$ zone 2
<b>support unit</b>								
	<b>30-28ML</b>	One 28" metal leg				class cwt lb cu ft	<b>145</b>	<b>145</b>
	<b>30-28WL</b>	One 28" wood leg				class cwt lb cu ft	<b>128</b>	<b>128</b>
	<b>30-24ES</b>	24" wide wood support panel	24	27.75		class cwt lb cu ft	<b>197</b>	<b>213</b>
	<b>30-30ES</b>	30" wide wood support panel	30	27.75		class cwt lb cu ft	<b>225</b>	<b>243</b>
	<b>30-36ES</b>	36" wide wood support panel	36	27.75		class cwt lb cu ft	<b>265</b>	<b>286</b>
	<b>30-48ES</b>	48" wide wood support panel	48	27.75		class cwt lb cu ft	<b>375</b>	<b>405</b>









saleer  
3000/3100/3200

cabinet  
finishes

**2ML-W** Natural maple  
**3ML-W** Light maple  
**4ML-W** Medium maple  
**5ML-W** Cherry maple

**1CM-W** Coffee on maple  
**2UM-W** Umber on maple  
**3SM-W** Shadow on maple

privacy screen

	<b>30-PP24</b>	24" acrylic privacy screen and gasket	12.25 24	class cwt lb cu ft	<b>181</b>	<b>181</b>
	<b>30-PP36</b>	36" acrylic privacy screen and gasket	12.25 36	class cwt lb cu ft	<b>270</b>	<b>270</b>
	<b>30-PP40</b>	40" acrylic privacy screen and gasket	12.25 40	class cwt lb cu ft	<b>361</b>	<b>361</b>
	<b>30-PP60</b>	60" acrylic privacy screen and gasket	12.25 60	class cwt lb cu ft	<b>451</b>	<b>451</b>
	<b>30-PP66</b>	66" acrylic privacy screen and gasket	12.25 66	class cwt lb cu ft	<b>496</b>	<b>496</b>
	<b>30-PP72</b>	72" acrylic privacy screen and gasket	12.25 72	class cwt lb cu ft	<b>541</b>	<b>541</b>
	<b>30-PP84</b>	84" acrylic privacy screen and gasket	12.25 84	class cwt lb cu ft	<b>631</b>	<b>631</b>
	<b>30-PP96</b>	96" acrylic privacy screen and gasket	96 12.25	class cwt lb cu ft	<b>720</b>	<b>720</b>



	model number	description	d	w	h	freight	list \$ zone 1	list \$ zone 2
<b>36"x24"x28"h cabinets</b>								
	32-M3628O - __	Metal leg support, open cabinet, one adj shelf <i>CABINET BACK TO BE ORDERED SEPARATELY</i>	24	36	28	class 125 cwt lb cu ft	1,209	1,306
	32-M3628D - __	Metal leg support, hinged doors, one adj shelf <i>CABINET BACK TO BE ORDERED SEPARATELY</i>	24	36	28	class 125 cwt lb cu ft	1,446	1,562
	32-M3628BO - __	Metal leg support ,1 box drw, open below <i>CABINET BACK TO BE ORDERED SEPARATELY</i>	24	36	28	class 125 cwt lb cu ft	1,391	1,503
	32-M36282BO - __	Metal leg support, 2 box drw, open below <i>CABINET BACK TO BE ORDERED SEPARATELY</i>	24	36	28	class 125 cwt lb cu ft	1,573	1,699
	32-M36283BO - __	Metal leg support, 3 box drw, open below <i>CABINET BACK TO BE ORDERED SEPARATELY</i>	24	36	28	class 125 cwt lb cu ft	1,755	1,896
	32-M36284B - __	Metal leg support, 4 box drw <i>CABINET BACK TO BE ORDERED SEPARATELY</i>	24	36	28	class 125 cwt lb cu ft	1,937	2,092
	32-M3628OF - __	Metal leg support, open, w/ file drw <i>CABINET BACK TO BE ORDERED SEPARATELY</i>	24	36	28	class 125 cwt lb cu ft	1,472	1,590
	32-M3628OBF - __	Metal leg support, open, 1 box, 1 file drws <i>CABINET BACK TO BE ORDERED SEPARATELY</i>	24	36	28	class 125 cwt lb cu ft	1,654	1,787
	32-M36282BF - __	Metal leg support, 2 box, 1 file drws <i>CABINET BACK TO BE ORDERED SEPARATELY</i>	24	36	28	class 125 cwt lb cu ft	1,836	1,983
	32-M36282F - __	Metal leg support, 2 file drws <i>CABINET BACK TO BE ORDERED SEPARATELY</i>	24	36	28	class 125 cwt lb cu ft	1,735	1,874

cabinet finishes

2ML-W Natural maple  
3ML-W Light maple  
4ML-W Medium maple  
5ML-W Cherry maple

1CM-W Coffee on maple  
2UM-W Umber on maple  
3SM-W Shadow on maple

saleer  
3000/3100/3200







	model number	description	d	w	h	freight	list \$ zone 1	list \$ zone 2
<b>30"x24"x28"h cabinets</b>								
	32-M3028O - __	Metal leg support, open cabinet, one adj shelf <i>CABINET BACK TO BE ORDERED SEPARATELY</i>	24	30	28	class 125 cwt lb cu ft	1,372	1,482
	32-M3028D - __	Metal leg support, hinged doors, one adj shelf <i>CABINET BACK TO BE ORDERED SEPARATELY</i>	24	30	28	class 125 cwt lb cu ft	1,135	1,226
	32-M3028BO - __	Metal leg support, 1 box drw, open below <i>CABINET BACK TO BE ORDERED SEPARATELY</i>	24	30	28	class 125 cwt lb cu ft	1,317	1,423
	32-M30282BO - __	Metal leg support, 2 box drw, open below <i>CABINET BACK TO BE ORDERED SEPARATELY</i>	24	30	28	class 125 cwt lb cu ft	1,499	1,619
	32-M30283BO - __	Metal leg support, 3 box drw, open below <i>CABINET BACK TO BE ORDERED SEPARATELY</i>	24	30	28	class 125 cwt lb cu ft	1,681	1,816
	32-M30284B - __	Metal leg support, 4 box drw <i>CABINET BACK TO BE ORDERED SEPARATELY</i>	24	30	28	class 125 cwt lb cu ft	1,863	2,012
	32-M3028OF - __	Metal leg support, open, w/ file drw <i>CABINET BACK TO BE ORDERED SEPARATELY</i>	24	30	28	class 125 cwt lb cu ft	1,398	1,510
	32-M3028OBF - __	Metal leg support, open, 1 box, 1 file drws <i>CABINET BACK TO BE ORDERED SEPARATELY</i>	24	30	28	class 125 cwt lb cu ft	1,580	1,707
	32-M30282BF - __	Metal leg support, 2 box, 1 file drws <i>CABINET BACK TO BE ORDERED SEPARATELY</i>	24	30	28	class 125 cwt lb cu ft	1,762	1,903
	32-M30282F - __	Metal leg support, 2 file drws <i>CABINET BACK TO BE ORDERED SEPARATELY</i>	24	30	28	class 125 cwt lb cu ft	1,661	1,794

cabinet finishes

2ML-W Natural maple  
3ML-W Light maple  
4ML-W Medium maple  
5ML-W Cherry maple

1CM-W Coffee on maple  
2UM-W Umber on maple  
3SM-W Shadow on maple

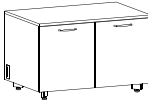
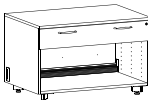

	model number	description	d	w	h	freight	list \$ zone 1	list \$ zone 2
<b>16"x30"x28"h cabinets</b>								
	32-M1630282F - _	Metal leg support, desk ped, 2 file drws <i>CABINET BACK TO BE ORDERED SEPARATELY</i>	16	30	28	class 125 cwt 105 lb cu ft 10	1,806	1,951
	32-M1630282BF - _	Metal leg support, desk ped, 2 box, 1 file drws <i>CABINET BACK TO BE ORDERED SEPARATELY</i>	16	30	28	class 125 cwt 105 lb cu ft 10	2,024	2,186
<b>16"x24"x28"h cabinets</b>								
	32-M1624282F - _	Metal leg support, credenza ped, 2 file drws <i>CABINET BACK TO BE ORDERED SEPARATELY</i>	16	24	28	class 125 cwt 95 lb cu ft 8	1,672	1,806
	32-M1624282BF - _	Metal leg support, credenza ped, 2 box, 1 file drws <i>CABINET BACK TO BE ORDERED SEPARATELY</i>	16	24	28	class 125 cwt 95 lb cu ft 8	1,890	2,041
<b>36"x24"x22"h cabinets</b>								
	32-M3622O - _	Metal leg support, open cabinet, one adj shelf <i>CABINET BACK TO BE ORDERED SEPARATELY</i>	24	36	22	class 125 cwt lb cu ft	1,159	1,252
	32-M3622D - _	Metal leg support, hinged doors ,one adj shelf <i>CABINET BACK TO BE ORDERED SEPARATELY</i>	24	36	22	class 125 cwt lb cu ft	1,396	1,508
	32-M3622BO - _	Metal leg support, 1 box drw, open below <i>CABINET BACK TO BE ORDERED SEPARATELY</i>	24	36	22	class 125 cwt lb cu ft	1,341	1,449
	32-M36222BO - _	Metal leg support, 2 box drws, open below <i>CABINET BACK TO BE ORDERED SEPARATELY</i>	24	36	22	class 125 cwt lb cu ft	1,523	1,645
	32-M36223B - _	Metal leg support, 3 box drws <i>CABINET BACK TO BE ORDERED SEPARATELY</i>	24	36	22	class 125 cwt lb cu ft	1,705	1,842









saleer  
3000/3100/3200

cabinet finishes

2ML-W Natural maple  
3ML-W Light maple  
4ML-W Medium maple  
5ML-W Cherry maple

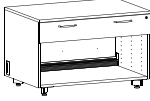
1CM-W Coffee on maple  
2UM-W Umber on maple  
3SM-W Shadow on maple







	model number	description	d	w	h	freight	list \$ zone 1	list \$ zone 2	
<b>36"x24"x22"h cabinets</b>									
	32-M3622OF - __	Metal leg support, open, w/ file drw <i>CABINET BACK TO BE ORDERED SEPARATELY</i>	24	36	22	class cwt cu ft	125 lb	1,422	1,536
	32-M3622BF - __	Metal leg support, 1 box, 1 file drws <i>CABINET BACK TO BE ORDERED SEPARATELY</i>	24	36	22	class cwt cu ft	125 lb	1,604	1,733
<b>30"x24"x22"h cabinets</b>									
	32-M3022O - __	Metal leg support, open cabinet, one adj shelf <i>CABINET BACK TO BE ORDERED SEPARATELY</i>	24	30	22	class cwt cu ft	125 lb	1,085	1,172
	32-M3022D - __	Metal leg support, hinged doors, one adj shelf <i>CABINET BACK TO BE ORDERED SEPARATELY</i>	24	30	22	class cwt cu ft	125 lb	1,322	1,428
	32-M3022BO - __	Metal leg support, 1 box drw, open below <i>CABINET BACK TO BE ORDERED SEPARATELY</i>	24	30	22	class cwt cu ft	125 lb	1,267	1,369
	32-M3022BO - __	Metal leg support, 2 box drws, open below <i>CABINET BACK TO BE ORDERED SEPARATELY</i>	24	30	22	class cwt cu ft	125 lb	1,449	1,565
	32-M30223B - __	Metal leg support, 3 box drws <i>CABINET BACK TO BE ORDERED SEPARATELY</i>	24	30	22	class cwt cu ft	125 lb	1,631	1,762
	32-M3022OF - __	Metal leg support, open, w/ file drw <i>CABINET BACK TO BE ORDERED SEPARATELY</i>	24	30	22	class cwt cu ft	125 lb	1,348	1,456
	32-M3022BF - __	Metal leg support, 1 box, 1 file drws <i>CABINET BACK TO BE ORDERED SEPARATELY</i>	24	30	22	class cwt cu ft	125 lb	1,530	1,653

cabinet  
finishes

2ML-W Natural maple  
3ML-W Light maple  
4ML-W Medium maple  
5ML-W Cherry maple

1CM-W Coffee on maple  
2UM-W Umber on maple  
3SM-W Shadow on maple



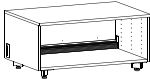
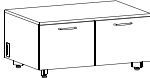
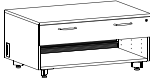
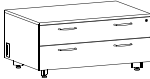
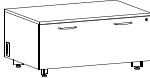

	model number	description	d	w	h	freight	list \$ zone 1	list \$ zone 2
<b>16"x30"x22"h cabinets</b>								
	<b>32-M163022BF</b> - __	Metal leg support, desk ped, 1 box, 1 file drws <i>CABINET BACK TO BE ORDERED SEPARATELY</i>	16	30	22	class 125 cwt 102 lb cu ft 10	<b>1,732</b>	<b>1,871</b>
	<b>32-M1630223B</b> - __	Metal leg support, desk ped, 3 box drws <i>CABINET BACK TO BE ORDERED SEPARATELY</i>	16	30	22	class 125 cwt 102 lb cu ft 10	<b>1,950</b>	<b>2,106</b>
<b>16"x24"x22"h cabinets</b>								
	<b>32-M162422BF</b> - __	Metal leg support, credenza ped, 1 box, 1 file drws <i>CABINET BACK TO BE ORDERED SEPARATELY</i>	16	24	22	class 125 cwt 92 lb cu ft 8	<b>1,598</b>	<b>1,726</b>
	<b>32-M1624223B</b> - __	Metal leg support, credenza ped, 3 box <i>CABINET BACK TO BE ORDERED SEPARATELY</i>	16	24	22	class 125 cwt 92 lb cu ft 8	<b>1,816</b>	<b>1,962</b>
<b>36"x24"x16"h cabinets</b>								
	<b>32-M3616O</b> - __	Metal leg support, open cabinet, one adj shelf <i>CABINET BACK TO BE ORDERED SEPARATELY</i>	24	36	16	class 125 cwt lb cu ft	<b>1,010</b>	<b>1,091</b>
	<b>32-M3616D</b> - __	Metal leg support, hinged doors, one adj shelf <i>CABINET BACK TO BE ORDERED SEPARATELY</i>	24	36	16	class 125 cwt lb cu ft	<b>1,247</b>	<b>1,347</b>
	<b>32-M3616BO</b> - __	Metal leg support, 1 box drw, open below <i>CABINET BACK TO BE ORDERED SEPARATELY</i>	24	36	16	class 125 cwt lb cu ft	<b>1,192</b>	<b>1,288</b>
	<b>32-M36162B</b> - __	Metal leg support, 2 box drws <i>CABINET BACK TO BE ORDERED SEPARATELY</i>	24	36	16	class 125 cwt lb cu ft	<b>1,374</b>	<b>1,484</b>
	<b>32-M3616F</b> - __	Metal leg support, file drw <i>CABINET BACK TO BE ORDERED SEPARATELY</i>	24	36	16	class 125 cwt lb cu ft	<b>1,354</b>	<b>1,463</b>

saleer 3000/3100/3200

cabinet finishes

**2ML-W** Natural maple  
**3ML-W** Light maple  
**4ML-W** Medium maple  
**5ML-W** Cherry maple

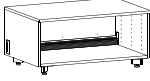
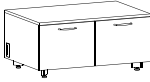
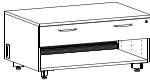
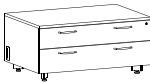
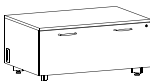
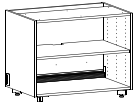
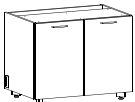
**1CM-W** Coffee on maple  
**2UM-W** Umber on maple  
**3SM-W** Shadow on maple

	model number	description	d	w	h	freight	list \$ zone 1	list \$ zone 2	
<b>30"x24"x16"h cabinets</b>									
	<b>32-M3016O</b> - __	Metal leg support, open cabinet, one adj shelf <i>CABINET BACK TO BE ORDERED SEPARATELY</i>	24	30	16	class cwt cu ft	125 lb	<b>936</b>	<b>1,011</b>
	<b>32-M3016D</b> - __	Metal leg support, hinged doors, one adj shelf <i>CABINET BACK TO BE ORDERED SEPARATELY</i>	24	30	16	class cwt cu ft	125 lb	<b>1,173</b>	<b>1,267</b>
	<b>32-M3016BO</b> - __	Metal leg support, 1 box drw, open below <i>CABINET BACK TO BE ORDERED SEPARATELY</i>	24	30	16	class cwt cu ft	125 lb	<b>1,118</b>	<b>1,208</b>
	<b>32-M30162B</b> - __	Metal leg support, 2 box drws <i>CABINET BACK TO BE ORDERED SEPARATELY</i>	24	30	16	class cwt cu ft	125 lb	<b>1,300</b>	<b>1,404</b>
	<b>32-M3016F</b> - __	Metal leg support, file drws <i>CABINET BACK TO BE ORDERED SEPARATELY</i>	24	30	16	class cwt cu ft	125 lb	<b>1,199</b>	<b>1,295</b>
<b>36"x24"x28"h cabinets</b>									
	<b>32-W3628O</b> - __	Wood leg support, open cabinet, one adj shelf <i>CABINET BACK TO BE ORDERED SEPARATELY</i>	24	36	28	class cwt cu ft	125 lb	<b>1,081</b>	<b>1,168</b>
	<b>32-W3628D</b> - __	Wood leg support, hinged doors, one adj shelf <i>CABINET BACK TO BE ORDERED SEPARATELY</i>	24	36	28	class cwt cu ft	125 lb	<b>1,318</b>	<b>1,424</b>
	<b>32-W3628BO</b> - __	Wood leg support, 1 box drw, open below <i>CABINET BACK TO BE ORDERED SEPARATELY</i>	24	36	28	class cwt cu ft	125 lb	<b>1,318</b>	<b>1,424</b>
	<b>32-W36282BO</b> - __	Wood leg support, 2 box drw, open below <i>CABINET BACK TO BE ORDERED SEPARATELY</i>	24	36	28	class cwt cu ft	125 lb	<b>1,445</b>	<b>1,561</b>





saler  
3000/3100/3200

cabinet  
finishes

**2ML-W** Natural maple  
**3ML-W** Light maple  
**4ML-W** Medium maple  
**5ML-W** Cherry maple

**1CM-W** Coffee on maple  
**2UM-W** Umber on maple  
**3SM-W** Shadow on maple

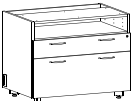
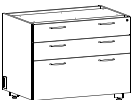

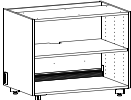
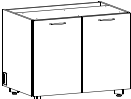
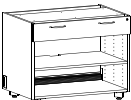





	model number	description	d	w	h	freight	list \$ zone 1	list \$ zone 2
<b>36"x24"x28"h cabinets</b>								
	32-W36283BO - __	Wood leg support, 3 box drw, open below <i>CABINET BACK TO BE ORDERED SEPARATELY</i>	24	36	28	class 125 cwt lb cu ft	1,627	1,757
	32-W36284B - __	Wood leg support, 4 box drw <i>CABINET BACK TO BE ORDERED SEPARATELY</i>	24	36	28	class 125 cwt lb cu ft	1,809	1,954
	32-W3628OF - __	Wood leg support, open, w/ file drw <i>CABINET BACK TO BE ORDERED SEPARATELY</i>	24	36	28	class 125 cwt lb cu ft	1,344	1,452
	32-W3628OBF - __	Wood leg support, open, 1 box, 1 file drws <i>CABINET BACK TO BE ORDERED SEPARATELY</i>	24	36	28	class 125 cwt lb cu ft	1,526	1,648
	32-W36282BF - __	Wood leg support, 2 box, 1 file drws <i>CABINET BACK TO BE ORDERED SEPARATELY</i>	24	36	28	class 125 cwt lb cu ft	1,708	1,845
	32-W36282F - __	Wood leg support, 2 file drws <i>CABINET BACK TO BE ORDERED SEPARATELY</i>	24	36	28	class 125 cwt lb cu ft	1,607	1,736
<b>30"x24"x28"h cabinets</b>								
	32-W3028O - __	Wood leg support, open cabinet, one adj shelf <i>CABINET BACK TO BE ORDERED SEPARATELY</i>	24	30	28	class 125 cwt lb cu ft	1,007	1,088
	32-W3028D - __	Wood leg support, hinged doors, one adj shelf <i>CABINET BACK TO BE ORDERED SEPARATELY</i>	24	30	28	class 125 cwt lb cu ft	1,244	1,344
	32-W3028BO - __	Wood leg support, 1 box drw, open below <i>CABINET BACK TO BE ORDERED SEPARATELY</i>	24	30	28	class 125 cwt lb cu ft	1,189	1,284

saleer 3000/3100/3200

cabinet finishes

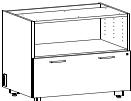
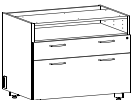
2ML-W Natural maple  
3ML-W Light maple  
4ML-W Medium maple  
5ML-W Cherry maple

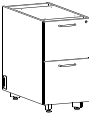
1CM-W Coffee on maple  
2UM-W Umber on maple  
3SM-W Shadow on maple









	model number	description	d	w	h	freight	list \$ zone 1	list \$ zone 2
<b>30"x24"x28"h cabinets</b>								
	32-W30282BO - __	Wood leg support, 2 box drw, open below <i>CABINET BACK TO BE ORDERED SEPARATELY</i>	24	30	28	class 125 cwt lb cu ft	1,371	1,481
	32-W30283BO - __	Wood leg support, 3 box drw, open below <i>CABINET BACK TO BE ORDERED SEPARATELY</i>	24	30	28	class 125 cwt lb cu ft	1,553	1,677
	32-W30284B - __	Wood leg support, 4 box drw <i>CABINET BACK TO BE ORDERED SEPARATELY</i>	24	30	28	class 125 cwt lb cu ft	1,735	1,874
	32-W3028OF - __	Wood leg support, open, w/ file drw	24	30	28	class 125 cwt lb cu ft	1,270	1,372
	32-W3028OBF - __	Wood leg support, open, 1 box, 1 file drws	24	30	28	class 125 cwt lb cu ft	1,452	1,568
	32-W30282BF - __	Wood leg support, 2 box, 1 file drws <i>CABINET BACK TO BE ORDERED SEPARATELY</i>	24	30	28	class 125 cwt lb cu ft	1,634	1,765
	32-W30282F - __	Wood leg support, 2 file drws <i>CABINET BACK TO BE ORDERED SEPARATELY</i>	24	30	28	class 125 cwt lb cu ft	1,533	1,656
<b>16"x30"x28"h cabinets</b>								
	32-W1630282F - __	Wood leg support, desk ped, 2 file drws <i>CABINET BACK TO BE ORDERED SEPARATELY</i>	16	30	28	class 125 cwt 105 lb cu ft 10	1,678	1,812
	32-W1630282BF - __	Wood leg support, desk ped, 2 box, 1 file drws <i>CABINET BACK TO BE ORDERED SEPARATELY</i>	16	30	28	class 125 cwt 105 lb cu ft 10	1,896	2,048

cabinet  
finishes

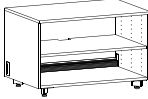
2ML-W Natural maple  
3ML-W Light maple  
4ML-W Medium maple  
5ML-W Cherry maple

1CM-W Coffee on maple  
2UM-W Umber on maple  
3SM-W Shadow on maple











	model number	description	d	w	h	freight	list \$ zone 1	list \$ zone 2
<b>16"x24"x28"h cabinets</b>								
	<b>32-W1624282F</b> - __	Wood leg support, credenza ped, 2 file drws <i>CABINET BACK TO BE ORDERED SEPARATELY</i>	16	24	28	class 125 cwt 95 lb cu ft 8	<b>1,544</b>	<b>1,668</b>
	<b>32-W1624282BF</b> - __	Wood leg support, credenza ped, 2 box, 1 file drws <i>CABINET BACK TO BE ORDERED SEPARATELY</i>	16	24	28	class 125 cwt 95 lb cu ft 8	<b>1,762</b>	<b>1,903</b>
<b>36"x24"x22"h cabinets</b>								
	<b>32-W36220</b> - __	Wood leg support, open cabinet, one adj shelf <i>CABINET BACK TO BE ORDERED SEPARATELY</i>	24	36	22	class 125 cwt lb cu ft	<b>1,031</b>	<b>1,114</b>
	<b>32-W3622D</b> - __	Wood leg support, hinged doors, one adj shelf cabinet back to be ordered separately	24	36	22	class 125 cwt lb cu ft	<b>1,268</b>	<b>1,370</b>
	<b>32-W3622BO</b> - __	Wood leg support, 1 box drw, open below <i>CABINET BACK TO BE ORDERED SEPARATELY</i>	24	36	22	class 125 cwt lb cu ft	<b>1,213</b>	<b>1,310</b>
	<b>32-W3622BO</b> - __	Wood leg support, 2 box drws, open below <i>CABINET BACK TO BE ORDERED SEPARATELY</i>	24	36	22	class 125 cwt lb cu ft	<b>1,395</b>	<b>1,507</b>
	<b>32-W36223B</b> - __	Wood leg support, 3 box drws cabinet back to be ordered separately	24	36	22	class 125 cwt lb cu ft	<b>1,577</b>	<b>1,703</b>
	<b>32-W3622OF</b> - __	Wood leg support, open, w/ file drw <i>CABINET BACK TO BE ORDERED SEPARATELY</i>	24	36	22	class 125 cwt lb cu ft	<b>1,294</b>	<b>1,398</b>
	<b>32-W3622BF</b> - __	Wood leg support, 1 box, 1 file drws <i>CABINET BACK TO BE ORDERED SEPARATELY</i>	24	36	22	class 125 cwt lb cu ft	<b>1,476</b>	<b>1,594</b>

saleer 3000/3100/3200

cabinet finishes

**2ML-W** Natural maple  
**3ML-W** Light maple  
**4ML-W** Medium maple  
**5ML-W** Cherry maple

**1CM-W** Coffee on maple  
**2UM-W** Umber on maple  
**3SM-W** Shadow on maple

	model number	description	d	w	h	freight	list \$ zone 1	list \$ zone 2
<b>30"x24"x22"h cabinets</b>								
	32-W3022O - __	Wood leg support, open cabinet, one adj shelf <i>CABINET BACK TO BE ORDERED SEPARATELY</i>	24	30	22	class 125 cwt lb cu ft	957	1,034
	32-W3022D - __	Wood leg support, hinged doors, one adj shelf <i>CABINET BACK TO BE ORDERED SEPARATELY</i>	24	30	22	class 125 cwt lb cu ft	1,194	1,290
	32-W3022BO - __	Wood leg support, 1 box drw, open below <i>CABINET BACK TO BE ORDERED SEPARATELY</i>	24	30	22	class 125 cwt lb cu ft	1,139	1,230
	32-W3022BO - __	Wood leg support, 2 box drws, open below <i>CABINET BACK TO BE ORDERED SEPARATELY</i>	24	30	22	class 125 cwt lb cu ft	1,321	1,427
	32-W30223B - __	Wood leg support, 3 box drws <i>CABINET BACK TO BE ORDERED SEPARATELY</i>	24	30	22	class 125 cwt lb cu ft	1,503	1,623
	32-W3022OF - __	Wood leg support, open, w/ file drw <i>CABINET BACK TO BE ORDERED SEPARATELY</i>	24	30	22	class 125 cwt lb cu ft	1,220	1,318
	32-W3022BF - __	Wood leg support, 1 box, 1 file drws <i>CABINET BACK TO BE ORDERED SEPARATELY</i>	24	30	22	class 125 cwt lb cu ft	1,402	1,514
<b>16"x30"x22"h cabinets</b>								
	32-W163022BF - __	Wood leg support, desk ped, 1 box, 1 file drws <i>CABINET BACK TO BE ORDERED SEPARATELY</i>	16	30	22	class 125 cwt 102 lb cu ft 10	1,604	1,733
	32-W1630223B - __	Wood leg support, desk ped, 3 box drws <i>CABINET BACK TO BE ORDERED SEPARATELY</i>	16	30	22	class 125 cwt 102 lb cu ft 10	1,822	1,968



saler 3000/3100/3200

cabinet finishes

2ML-W Natural maple  
3ML-W Light maple  
4ML-W Medium maple  
5ML-W Cherry maple

1CM-W Coffee on maple  
2UM-W Umber on maple  
3SM-W Shadow on maple



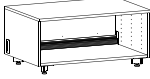
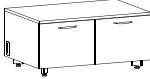
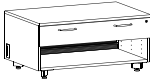
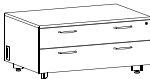
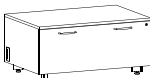
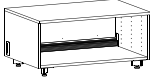
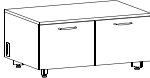





	model number	description	d	w	h	freight	list \$ zone 1	list \$ zone 2
<b>16"x24"x22"h cabinets</b>								
	32-W162422BF - __	Wood leg support, credenza ped, 1 box, 1 file drw <i>CABINET BACK TO BE ORDERED SEPARATELY</i>	16	24	22	class 125 cwt 92 lb cu ft 8	1,470	1,588
	32-W1624223B - __	Wood leg support, credenza ped, 3 box drws <i>CABINET BACK TO BE ORDERED SEPARATELY</i>	16	24	22	class 125 cwt 92 lb cu ft 8	1,688	1,823
<b>36"x24"x16"h cabinets</b>								
	32-W3616O - __	Wood leg support, open cabinet, one adj shelf <i>CABINET BACK TO BE ORDERED SEPARATELY</i>	24	36	16	class 125 cwt lb cu ft	882	1,034
	32-W3616D - __	Wood leg support, hinged doors, one adj shelf <i>CABINET BACK TO BE ORDERED SEPARATELY</i>	24	36	16	class 125 cwt lb cu ft	1,119	953
	32-W3616BO - __	Wood leg support, 1 box drw, open below <i>CABINET BACK TO BE ORDERED SEPARATELY</i>	24	36	16	class 125 cwt lb cu ft	1,064	1,230
	32-W36162B - __	Wood leg support, 2 box drws <i>CABINET BACK TO BE ORDERED SEPARATELY</i>	24	36	16	class 125 cwt lb cu ft	1,246	1,346
	32-W3616F - __	Wood leg support, file drw <i>CABINET BACK TO BE ORDERED SEPARATELY</i>	24	36	16	class 125 cwt lb cu ft	1,226	1,324
<b>30"x24"x16"h cabinets</b>								
	32-W3016O - __	Wood leg support, open cabinet, one adj shelf <i>CABINET BACK TO BE ORDERED SEPARATELY</i>	24	30	16	class 125 cwt lb cu ft	808	873
	32-W3016D - __	Wood leg support, hinged doors, one adj shelf <i>CABINET BACK TO BE ORDERED SEPARATELY</i>	24	30	16	class 125 cwt lb cu ft	1,045	1,129

cabinet finishes

2ML-W Natural maple  
3ML-W Light maple  
4ML-W Medium maple  
5ML-W Cherry maple

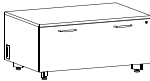
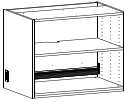
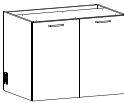
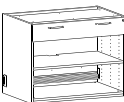
1CM-W Coffee on maple  
2UM-W Umber on maple  
3SM-W Shadow on maple



	model number	description	d	w	h	freight	list \$ zone 1	list \$ zone 2
<b>30"x24"x16"h cabinets</b>								
	32-W3016BO - __	Wood leg support, 1 box drw, open below <i>CABINET BACK TO BE ORDERED SEPARATELY</i>	24	30	16	class 125 cwt lb cu ft	990	1,069
	32-W30162B - __	Wood leg support, 2 box drws <i>CABINET BACK TO BE ORDERED SEPARATELY</i>	24	30	16	class 125 cwt lb cu ft	1,172	1,266
	32-W3016F - __	Wood leg support, file drw <i>CABINET BACK TO BE ORDERED SEPARATELY</i>	24	30	16	class 125 cwt lb cu ft	1,071	1,157
<b>36"x24"x28"h cabinets</b>								
	31-3628O - __	Case support, open cabinet, one adj shelf <i>CABINET BACK TO BE ORDERED SEPARATELY</i>	24	36	28	class 125 cwt lb cu ft	889	960
	31-3628D - __	Case support, hinged doors, one adj shelf <i>CABINET BACK TO BE ORDERED SEPARATELY</i>	24	36	28	class 125 cwt lb cu ft	1,126	1,216
	31-3628BO - __	Case support, 1 box drw, open below <i>CABINET BACK TO BE ORDERED SEPARATELY</i>	24	36	28	class 125 cwt lb cu ft	1,071	1,157
	31-36282BO - __	Case support, 2 box drw, open below <i>CABINET BACK TO BE ORDERED SEPARATELY</i>	24	36	28	class 125 cwt lb cu ft	1,253	1,353
	31-36283BO - __	Case support, 3 box drw, open below <i>CABINET BACK TO BE ORDERED SEPARATELY</i>	24	36	28	class 125 cwt lb cu ft	1,435	1,550
	31-36284B - __	Case support, 4 box drw <i>CABINET BACK TO BE ORDERED SEPARATELY</i>	24	36	28	class 125 cwt lb cu ft	1,617	1,747







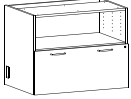

saler 3000/3100/3200

cabinet finishes

2ML-W Natural maple  
3ML-W Light maple  
4ML-W Medium maple  
5ML-W Cherry maple

1CM-W Coffee on maple  
2UM-W Umber on maple  
3SM-W Shadow on maple



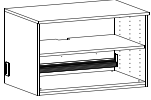





	model number	description	d	w	h	freight	list \$ zone 1	list \$ zone 2
<b>36"x24"x28"h cabinets</b>								
	31-3628OF - __	Case support, open, w/ file drw <i>CABINET BACK TO BE ORDERED SEPARATELY</i>	24	36	28	class 125 cwt lb cu ft	1,152	1,244
	31-36280BF - __	Case support, open, 1 box, 1 file drws <i>CABINET BACK TO BE ORDERED SEPARATELY</i>	24	36	28	class 125 cwt lb cu ft	1,334	1,441
	31-36282BF - __	Case support, 2 box, 1 file drws <i>CABINET BACK TO BE ORDERED SEPARATELY</i>	24	36	28	class 125 cwt lb cu ft	1,516	1,638
	31-36282F - __	Case support, 2 file drws <i>CABINET BACK TO BE ORDERED SEPARATELY</i>	24	36	28	class 125 cwt lb cu ft	1,415	1,528
<b>16"x30"x28"h cabinets</b>								
	31-1630282F - __	Case support, desk ped, 2 file drws <i>CABINET BACK TO BE ORDERED SEPARATELY</i>	16	30	28	class 125 cwt 105 lb cu ft 10	1,118	1,208
	31-1630282BF - __	Case support, desk ped, 2 box, 1 file drws <i>CABINET BACK TO BE ORDERED SEPARATELY</i>	16	30	28	class 125 cwt 105 lb cu ft 10	1,192	1,288
<b>16"x24"x28"h cabinets</b>								
	31-1624282F - __	Case support, credenza ped, 2 file drws <i>CABINET BACK TO BE ORDERED SEPARATELY</i>	16	24	28	class 125 cwt 95 lb cu ft 8	984	1,063
	31-1624282BF - __	Case support, credenza ped, 2 box, 1 file drws <i>CABINET BACK TO BE ORDERED SEPARATELY</i>	16	24	28	class 125 cwt 95 lb cu ft 8	1,075	1,161
<b>36"x24"x22"h cabinets</b>								
	31-36220 - __	Case support, open cabinet, one adj shelf <i>CABINET BACK TO BE ORDERED SEPARATELY</i>	24	36	22	class 125 cwt lb cu ft	839	906

saleer  
3000/3100/3200

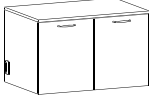
cabinet finishes

2ML-W Natural maple  
3ML-W Light maple  
4ML-W Medium maple  
5ML-W Cherry maple

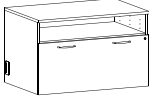
1CM-W Coffee on maple  
2UM-W Umber on maple  
3SM-W Shadow on maple

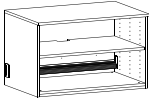
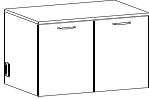
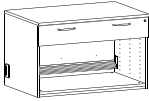
	model number	description	d	w	h	freight	list \$ zone 1	list \$ zone 2
<b>36"x24"x22"h cabinets</b>								
	31-3622D - __	Case support, hinged doors ,one adj shelf <i>CABINET BACK TO BE ORDERED SEPARATELY</i>	24	36	22	class cwt 125 lb cu ft	1,076	1,162
	31-3622BO - __	Case support, 1 box drw, open below, <i>CABINET BACK TO BE ORDERED SEPARATELY</i>	24	36	22	class cwt 125 lb cu ft	1,021	1,103
	31-3622BO - __	Case support, 2 box drws, open below <i>CABINET BACK TO BE ORDERED SEPARATELY</i>	24	36	22	class cwt 125 lb cu ft	1,203	1,299
	31-36223B - __	Case support, 3 box drws <i>CABINET BACK TO BE ORDERED SEPARATELY</i>	24	36	22	class cwt 125 lb cu ft	1,385	1,496
	31-3622OF - __	Case support, open, w/ file drw <i>CABINET BACK TO BE ORDERED SEPARATELY</i>	24	36	22	class cwt 125 lb cu ft	1,102	1,190
	31-3622BF - __	Case support, open, 1 box, 1 file drws <i>CABINET BACK TO BE ORDERED SEPARATELY</i>	24	36	22	class cwt 125 lb cu ft	1,284	1,387
<b>30"x24"x22"h cabinets</b>								
	31-3022O - __	Case support, open cabinet, one adj shelf <i>CABINET BACK TO BE ORDERED SEPARATELY</i>	24	30	22	class cwt 125 lb cu ft	765	826
	31-3022D - __	Case support, hinged doors, one adj shelf <i>CABINET BACK TO BE ORDERED SEPARATELY</i>	24	30	22	class cwt 125 lb cu ft	1,002	1,082
	31-3022BO - __	Case support, 1 box drw, open below <i>CABINET BACK TO BE ORDERED SEPARATELY</i>	24	30	22	class cwt 125 lb cu ft	947	1,023









saler  
3000/3100/3200

cabinet  
finishes

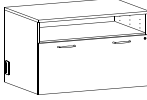
2ML-W Natural maple  
3ML-W Light maple  
4ML-W Medium maple  
5ML-W Cherry maple

1CM-W Coffee on maple  
2UM-W Umber on maple  
3SM-W Shadow on maple



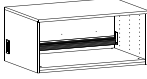

	model number	description	d	w	h	freight	list \$ zone 1	list \$ zone 2	
<b>30"x24"x22"h cabinets</b>									
	31-3022BO - __	Case support, 2 box drws, open below <i>CABINET BACK TO BE ORDERED SEPARATELY</i>	24	30	22	class 125 cwt lb cu ft	1,129	1,220	
	31-30223B - __	Case support, 3 box drws <i>CABINET BACK TO BE ORDERED SEPARATELY</i>	24	30	22	class 125 cwt lb cu ft	1,311	1,416	
	31-3022OF - __	Case support, open, w/ file drw <i>CABINET BACK TO BE ORDERED SEPARATELY</i>	24	30	22	class 125 cwt lb cu ft	1,028	1,110	
	31-3022BF - __	Case support, open, 1 box, 1 file drws <i>CABINET BACK TO BE ORDERED SEPARATELY</i>	24	30	22	class 125 cwt lb cu ft	1,210	1,307	
<b>16"x30"x22"h cabinets</b>									
	31-163022BF - __	Case support, desk ped, 1 box, 1 file drws <i>CABINET BACK TO BE ORDERED SEPARATELY</i>	16	30	22	class 125 cwt 102 lb cu ft 10	1,044	1,128	
	31-1630223B - __	Case support, desk ped, 3 box drws <i>CABINET BACK TO BE ORDERED SEPARATELY</i>	16	30	22	class 125 cwt 102 lb cu ft 10	1,118	1,208	
<b>16"x24"x22"h cabinets</b>									
	31-162422BF - __	Case support, credenza ped, 1 box, 1 file drw <i>CABINET BACK TO BE ORDERED SEPARATELY</i>	16	24	22	class 125 cwt 92 lb cu ft 8	910	983	
	31-1624223B - __	Case support, credenza ped, 3 box drws <i>CABINET BACK TO BE ORDERED SEPARATELY</i>	16	24	22	class 125 cwt 92 lb cu ft 8	984	1,063	
<b>36"x24"x16"h cabinets</b>									
	31-3616O - __	Case support, open cabinet, one adj shelf <i>CABINET BACK TO BE ORDERED SEPARATELY</i>	24	36	16	class 125 cwt lb cu ft	690	745	

saleer  
3000/3100/3200

cabinet finishes

2ML-W Natural maple  
3ML-W Light maple  
4ML-W Medium maple  
5ML-W Cherry maple

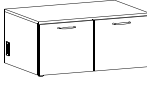
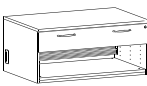
1CM-W Coffee on maple  
2UM-W Umber on maple  
3SM-W Shadow on maple

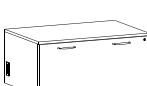
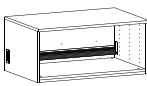
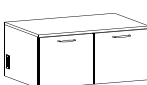
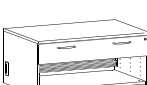
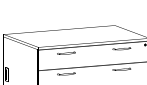
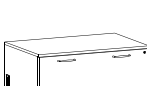
	model number	description	d	w	h	freight	list \$ zone 1	list \$ zone 2
<b>36"x24"x16"h cabinets</b>								
	31-3616D - __	Case support, hinged doors, one adj shelf <i>CABINET BACK TO BE ORDERED SEPARATELY</i>	24	36	16	class cwt 125 lb cu ft	927	1,001
	31-3616BO - __	Case support, 1 box drw, open below <i>CABINET BACK TO BE ORDERED SEPARATELY</i>	24	36	16	class cwt 125 lb cu ft	872	942
	31-36162B - __	Case support, 2 box drws <i>CABINET BACK TO BE ORDERED SEPARATELY</i>	24	36	16	class cwt 125 lb cu ft	1,054	1,139
	31-3616F - __	Case support, file drw <i>CABINET BACK TO BE ORDERED SEPARATELY</i>	24	36	16	class cwt 125 lb cu ft	953	1,029
<b>30"x24"x16"h cabinets</b>								
	31-3016O - __	Case support, open cabinet, one adj shelf <i>CABINET BACK TO BE ORDERED SEPARATELY</i>	24	30	16	class cwt 125 lb cu ft	616	666
	31-3016D - __	Case support, hinged doors, one adj shelf <i>CABINET BACK TO BE ORDERED SEPARATELY</i>	24	30	16	class cwt 125 lb cu ft	853	921
	31-3016BO - __	Case support, 1 box drw, open below <i>CABINET BACK TO BE ORDERED SEPARATELY</i>	24	30	16	class cwt 125 lb cu ft	798	862
	31-30162B - __	Case support, 2 box drws <i>CABINET BACK TO BE ORDERED SEPARATELY</i>	24	30	16	class cwt 125 lb cu ft	980	1,059
	31-3016F - __	Case support, file drw <i>CABINET BACK TO BE ORDERED SEPARATELY</i>	24	30	16	class cwt 125 lb cu ft	879	950

saler  
3000/3100/3200

cabinet  
finishes

2ML-W Natural maple  
3ML-W Light maple  
4ML-W Medium maple  
5ML-W Cherry maple

1CM-W Coffee on maple  
2UM-W Umber on maple  
3SM-W Shadow on maple



	model number	description	d	w	h	freight	list \$ zone 1	list \$ zone 2
<b>cabinet back 2</b>								
	31-BK3628 - __	Cabinet back	36	28		class 125 cwt lb cu ft	153	165
	31-BK3028 - __	Cabinet back	30	28		class 125 cwt lb cu ft	153	165
	31-BK3622 - __	Cabinet back	36	22		class 125 cwt lb cu ft	153	165
	31-BK3022 - __	Cabinet back	30	22		class 125 cwt lb cu ft	153	165
	31-BK3616 - __	Cabinet back	36	16		class 125 cwt lb cu ft	153	165
	31-BK3016 - __	Cabinet back	30	16		class 125 cwt lb cu ft	153	165
	31-BK1630-28 - __	*Desk cabinet back (must be ordered seperately)	16	28		class 125 cwt lb cu ft	109	118
	31-BK1630-22 - __	*Desk cabinet back (must be ordered seperately)	16	22		class 125 cwt lb cu ft	109	118
	31-BK1624-28 - __	*Credenza cabinet back (must be ordred seperately)	16	28		class 125 cwt lb cu ft	109	118
	31-BK1624-22 - __	*Credenza cabinet back (must be ordred seperately)	16	22		class 125 cwt lb cu ft	109	118

saleer  
3000/3100/3200

cabinet finishes

2ML-W Natural maple  
3ML-W Light maple  
4ML-W Medium maple  
5ML-W Cherry maple

1CM-W Coffee on maple  
2UM-W Umber on maple  
3SM-W Shadow on maple

	model number	description	d	w	h	freight	list \$ zone 1	list \$ zone 2
<b>cabinet back</b>								
	32-BK3628 - __	Cabinet back	36	28		class 125 cwt lb cu ft	153	165
	32-BK3028 - __	Cabinet back	30	28		class 125 cwt lb cu ft	153	165
	32-BK3622 - __	Cabinet back	36	22		class 125 cwt lb cu ft	153	165
	32-BK3022 - __	Cabinet back	30	22		class 125 cwt lb cu ft	153	165
	32-BK3616 - __	Cabinet back	36	16		class 125 cwt lb cu ft	153	165
	32-BK3016 - __	Cabinet back	30	16		class 125 cwt lb cu ft	153	165
	32-BK1630-28 - __	Desk cabinet back	16	28		class 125 cwt lb cu ft	109	118
	32-BK1630-22 - __	Desk cabinet back	16	22		class 125 cwt lb cu ft	109	118
	32-BK1624-28 - __	Credenza cabinet back	16	28		class 125 cwt lb cu ft	109	118
	32-BK1624-22 - __	Credenza cabinet back	16	22		class 125 cwt lb cu ft	109	118







saler  
3000/3100/3200

cabinet  
finishes

2ML-W Natural maple  
3ML-W Light maple  
4ML-W Medium maple  
5ML-W Cherry maple

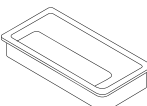
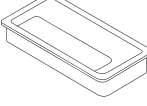
1CM-W Coffee on maple  
2UM-W Umber on maple  
3SM-W Shadow on maple











	model number	description	d	w	h	freight	list \$ zone 1	list \$ zone 2
<b>cabinet seat element</b>								
	30-SIT3624 - __	Cabinet seat element <i>MUST BE ATTACHED IN FIELD</i>	24	36	2.5	class cwt lb cu ft	g1 261 g2 292 g3 308 g4 339 g5 376 g6 382 g7 403	g1 282 g2 315 g3 333 g4 366 g5 406 g6 413 g7 435
	30-SIT3024 - __	Cabinet seat element <i>MUST BE ATTACHED IN FIELD</i>	24	30	2.5	class cwt lb cu ft	g1 215 g2 282 g3 298 g4 329 g5 366 g6 373 g7 393	g1 232 g2 305 g3 322 g4 355 g5 395 g6 403 g7 424
<b>pulls and grommets</b>								
	03114	Silver pulls are supplied on all cabinets as standard. Optional black pulls are available at no up charge. 30-BP must be specified for every cabinet requested with black pulls. Example 32-W3622O with 30-BP pulls.				class cwt lb cu ft	-	-
	RGS-GI	Rectangular silver (grey) grommet <i>SEE PAGES 380-385 OF ACCESSORY SECTION OF REGULAR PRICE LIST FOR OPTIONAL WORK SURFACE POWER AND COMMUNICATION RECEPTACLES AND TELECOM PLATES.</i>	2	4		class cwt lb cu ft	153	153
	RGS-BI	Rectangular black grommet <i>SEE PAGES 380-385 OF ACCESSORY SECTION OF REGULAR PRICE LIST FOR OPTIONAL WORK SURFACE POWER AND COMMUNICATION RECEPTACLES AND TELECOM PLATES.</i>	2	4		class cwt lb cu ft	153	153
<b>electrical wiring</b>								
	30-PT30-FM32	30" pass through cable with one female and one male connection and metal-flex cable <i>FOR USE TO PASS ELECTRICAL THROUGH ANY 30" CABINET</i>				class cwt lb cu ft	145	145
	30-PT36-FM38	36" pass through cable with one female and one male connection and metal-flex cable <i>FOR USE TO PASS ELECTRICAL THROUGH ANY 36" CABINET</i>				class cwt lb cu ft	155	155
	30-PP30-FF-12	Interconnecting metal flex cable interface with power module with 4 circuits including (1) isolated and dedicated circuit (allowing up to 13 receptacles per circuit). Cable has female polarized and color coded connections on both ends. (4 circuit plugs not shown in drawing) <i>FOR USE ON ANY 30" CABINET TO BRING POWER TO AND OUT OF CABINET</i>				class cwt lb cu ft	308	308
	30-PP36-FF-15	Interconnecting metal flex cable interface with power module with 4 circuits including (1) isolated and dedicated circuit (allowing up to 13 receptacles per circuit). Cable has female polarized and color coded connections on both ends. (4 circuit plugs not shown in drawing) <i>FOR USE ON ANY 36" CABINET TO BRING POWER TO AND OUT OF CABINET</i>				class cwt lb cu ft	318	318

cabinet finishes

2ML-W Natural maple  
3ML-W Light maple  
4ML-W Medium maple  
5ML-W Cherry maple

1CM-W Coffee on maple  
2UM-W Umber on maple  
3SM-W Shadow on maple

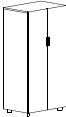
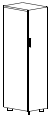







	model number	description	d	w	h	freight	list \$ zone 1	list \$ zone 2
<b>shelf</b>								
	30-30AS	Additional 30" adjustable shelf				class cwt lb cu ft	90	90
	30-30PS	Additional 30" pull out shelf <i>ON METAL SUSPENSION</i>				class cwt lb cu ft	137	137
	30-36AS	Additional 30" adjustable shelf				class cwt lb cu ft	95	95
	30-36PS	Additional 30" pull out shelf <i>ON METAL SUSPENSION</i>				class cwt lb cu ft	145	145
<b>mobile pedestal</b>								
	30-MP2F	Mobile pedestal 2 file drws	19	16	27	class cwt 80 lb cu ft 7	1,238	1,305
	30-MP3D	Mobile pedestal, 2 box, 1 file drws	19	16	27	class cwt 80 lb cu ft 7	1,213	1,289
<b>wardrobe</b>								
	32-MWD72	Wardrobe metal leg support double hinged door	36	24	72	class cwt 285 lb cu ft 42	2,744	2,963
	32-MWD72R-18	Wardrobe metal leg support one right hinged door	18	24	72	class cwt 200 lb cu ft 29	1,786	1,927
	32-MWD72L-18	Wardrobe metal leg support one left hinged door	18	24	72	class cwt 200 lb cu ft 29	1,786	1,927

cabinet  
finishes

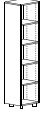
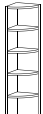
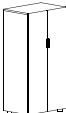
2ML-W Natural maple  
3ML-W Light maple  
4ML-W Medium maple  
5ML-W Cherry maple

1CM-W Coffee on maple  
2UM-W Umber on maple  
3SM-W Shadow on maple

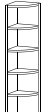
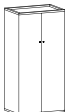

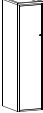

	model number	description	d	w	h	freight	list \$ zone 1	list \$ zone 2
<b>wardrobe</b>								
	<b>32-M72-BC</b>	Open bookcase metal leg support 3 adj. 1 fixed shelf	16	18	72	class cwt 200 lb cu ft 29	<b>1,435</b>	<b>1,550</b>
	<b>32-M72-BR</b>	Radius bookcase metal leg support 5 fixed shelves	16.5	16.5	72	class cwt 90 lb cu ft 14	<b>1,331</b>	<b>1,437</b>
	<b>32-WWD72</b>	Wardrobe wood leg support double hinged door	36	24	72	class cwt 285 lb cu ft 42	<b>2,616</b>	<b>2,825</b>
	<b>32-WWD72R-18</b>	Wardrobe wood leg support one right hinged door	18	24	72	class cwt 200 lb cu ft 29	<b>1,658</b>	<b>1,791</b>
	<b>32-WWD72L-18</b>	Wardrobe wood leg support one left hinged door	18	24	72	class cwt 200 lb cu ft 29	<b>1,658</b>	<b>1,791</b>
	<b>32-W72-BC</b>	Open bookcase wood leg support 3 adj. 1 fixed shelf	16	18	72	class cwt 200 lb cu ft 29	<b>1,307</b>	<b>1,412</b>
	<b>32-W72-BR</b>	Radius bookcase wood leg support 5 fixed shelves	16.5	16.5	72	class cwt 90 lb cu ft 14	<b>1,203</b>	<b>1,299</b>
	<b>30-WD72</b>	Wardrobe case support double hinged door	36	24	72	class cwt 285 lb cu ft 42	<b>3,655</b>	<b>3,948</b>
	<b>30-WD72R-18</b>	Wardrobe case support one right hinged door	18	24	72	class cwt 200 lb cu ft 29	<b>2,629</b>	<b>2,880</b>
	<b>30-72WDL-18</b>	Wardrobe case support one left hinged door	18	24	72	class cwt 200 lb cu ft 29	<b>2,629</b>	<b>2,880</b>

cabinet finishes

**2ML-W** Natural maple  
**3ML-W** Light maple  
**4ML-W** Medium maple  
**5ML-W** Cherry maple

**1CM-W** Coffee on maple  
**2UM-W** Umber on maple  
**3SM-W** Shadow on maple

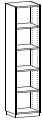
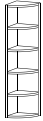
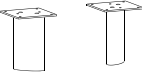
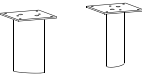
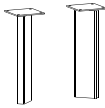
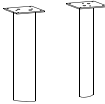
saleer  
3000/3100/3200

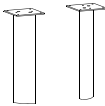
	model number	description	d	w	h	freight	list \$ zone 1	list \$ zone 2
<b>wardrobe</b>								
	30-72-BC	Open bookcase case support 3 adj. 1 fixed shelf	16	18	72	class cwt 200 lb cu ft 29	2,278	2,460
	30-72-BR	Radius bookcase case support 5 fixed shelves	16.5	16.5	72	class cwt 90 lb cu ft 14	1,047	1,132
<b>stanchion supports</b>								
	30-5MSTAN - __	One 5" metal stanchion				class cwt lb cu ft	129	129
	30-5WSTAN - __	One 5" wood stanchion				class cwt lb cu ft	68	68
	30-11MSTAN - __	One 11" metal stanchion				class cwt lb cu ft	133	133
	30-11WSTAN - __	One 11" wood stanchion				class cwt lb cu ft	71	71
	30-12MSTAN - __	One 12" metal stanchion				class cwt lb cu ft	135	135
	30-12WSTAN - __	One 12" wood stanchion				class cwt lb cu ft	73	73

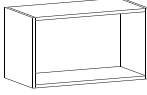
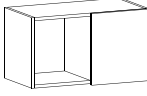
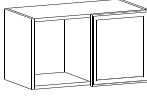
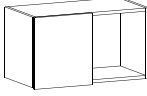
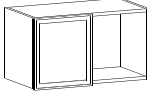
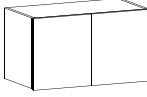
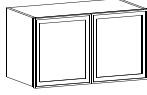
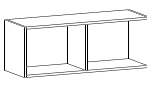
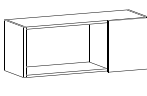
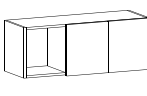

	model number	description	d	w	h	freight	list \$ zone 1	list \$ zone 2
<b>at reach storage units</b>								
	<b>30-AR30-O</b>	stanchion supported at reach storage open	16	30	17	class cwt 50 lb cu ft 8	<b>395</b>	<b>428</b>
	<b>30-AR30-OD</b>	stanchion supported at reach storage open, wood door right	16	30	17	class cwt 52 lb cu ft 8	<b>532</b>	<b>575</b>
	<b>30-AR30-OGD</b>	stanchion supported at reach storage open, metal framed glass door right	16	30	17	class cwt lb cu ft	<b>582</b>	<b>629</b>
	<b>30-AR30-DO</b>	stanchion supported at reach storage, left wood door, open	16	30	17	class cwt 52 lb cu ft 8	<b>532</b>	<b>575</b>
	<b>30-AR30-GDO</b>	stanchion supported at reach storage, left metal framed glass door, open	16	30	17	class cwt lb cu ft	<b>582</b>	<b>629</b>
	<b>30-AR30-2D</b>	stanchion supported at reach storage, 2 wood doors	16	30	17	class cwt 54 lb cu ft 8	<b>669</b>	<b>723</b>
	<b>30-AR30-2GD</b>	stanchion supported at reach storage 2 metal framed glass doors	16	30	17	class cwt lb cu ft	<b>769</b>	<b>831</b>
	<b>30-AR45-O</b>	stanchion supported at reach storage open	16	45	17	class cwt 75 lb cu ft 10	<b>715</b>	<b>772</b>
	<b>30-AR45-OD</b>	stanchion supported at reach storage open, hand wood door right	16	45	17	class cwt 77 lb cu ft 10	<b>852</b>	<b>920</b>
	<b>30-AR45-O2D</b>	stanchion supported at reach storage, open, 2 wood doors right	16	45	17	class cwt 80 lb cu ft 10	<b>989</b>	<b>1,068</b>

cabinet finishes

**2ML-W** Natural maple  
**3ML-W** Light maple  
**4ML-W** Medium maple  
**5ML-W** Cherry maple

**1CM-W** Coffee on maple  
**2UM-W** Umber on maple  
**3SM-W** Shadow on maple

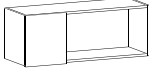
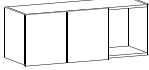
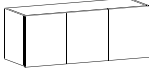
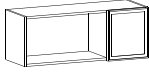
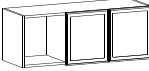
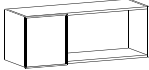
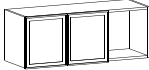
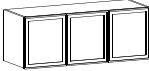
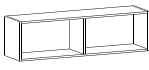
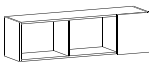





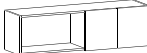
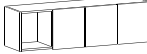

	model number	description	d	w	h	freight	list \$ zone 1	list \$ zone 2
<b>at reach storage units</b>								
	<b>30-AR45-DO</b>	stanchion supported at reach storage, left wood door, open	16	45	17	class cwt 77 lb cu ft 10	<b>852</b>	<b>920</b>
	<b>30-AR45-2DO</b>	stanchion supported at reach storage, 2 left wood doors, open	16	45	17	class cwt 80 lb cu ft 10	<b>989</b>	<b>1,068</b>
	<b>30-AR45-3D</b>	stanchion supported at reach storage, 3 wood doors	16	45	17	class cwt 82 lb cu ft 10	<b>1,126</b>	<b>1,216</b>
	<b>30-AR45-OGD</b>	stanchion supported at reach storage open, metal framed glass door right	16	45	17	class cwt lb cu ft	<b>902</b>	<b>974</b>
	<b>30-AR45-O2GD</b>	stanchion supported at reach storage open, 2 metal framed glass door right	16	45	17	class cwt lb cu ft	<b>1,089</b>	<b>1,176</b>
	<b>30-AR45-GDO</b>	stanchion supported at reach storage left metal framed glass door, open	16	45	17	class cwt lb cu ft	<b>902</b>	<b>974</b>
	<b>30-AR45-2GDO</b>	stanchion supported at reach storage left 2 metal framed glass door, open	16	45	17	class cwt lb cu ft	<b>1,089</b>	<b>1,176</b>
	<b>30-AR45-3GD</b>	stanchion supported at reach storage 3 metal framed glass doors	16	45	17	class cwt lb cu ft	<b>1,276</b>	<b>1,378</b>
	<b>30-AR60-O</b>	stanchion supported at reach storage open	16	60	17	class cwt lb cu ft	<b>782</b>	<b>845</b>
	<b>30-AR60-OD</b>	stanchion supported at reach storage open, wood door right	16	60	17	class cwt lb cu ft	<b>919</b>	<b>993</b>

cabinet  
finishes

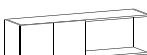
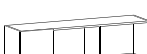
**2ML-W** Natural maple  
**3ML-W** Light maple  
**4ML-W** Medium maple  
**5ML-W** Cherry maple

**1CM-W** Coffee on maple  
**2UM-W** Umber on maple  
**3SM-W** Shadow on maple



	model number	description	d	w	h	freight	list \$ zone 1	list \$ zone 2
<b>at reach storage units</b>								
	30-AR60-O2D	stanchion supported at reach storage, open, 2 wood doors right	16	60	17	class cwt lb cu ft	1,056	1,140
	30-AR60-O3D	stanchion supported at reach storage, open, 3 wood doors right	16	60	17	class cwt lb cu ft	1,193	1,288
	30-AR60-3DO	stanchion supported at reach storage, left 3 wood doors, open	16	60	17	class cwt lb cu ft	1,193	1,288
	30-AR60-2DO	stanchion supported at reach storage, left 2 wood doors, open	16	60	17	class cwt lb cu ft	1,056	1,140
	30-AR60-DO	stanchion supported at reach storage left wood door, open	16	60	17	class cwt lb cu ft	919	993
	30-AR60-OGD	stanchion supported at reach storage open, metal framed glass door right	16	60	17	class cwt lb cu ft	969	1,047
	30-AR60-O2GD	stanchion supported at reach storage open, 2 metal framed glass door right	16	60	17	class cwt lb cu ft	1,156	1,248
	30-AR60-O3GD	stanchion supported at reach storage open, 3 metal framed glass doors right	16	60	17	class cwt lb cu ft	1,343	1,450
	30-AR60-3GDO	stanchion supported at reach storage , left 3 metal framed glass doors, open	16	60	17	class cwt lb cu ft	1,343	1,450
	30-AR60-2GDO	stanchion supported at reach storage, left 2 metal framed glass door, open	16	60	17	class cwt lb cu ft	1,156	1,248

cabinet finishes

2ML-W Natural maple  
3ML-W Light maple  
4ML-W Medium maple  
5ML-W Cherry maple

1CM-W Coffee on maple  
2UM-W Umber on maple  
3SM-W Shadow on maple

saleer  
3000/3100/3200

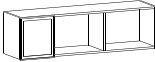
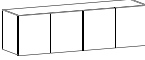
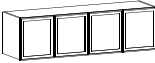
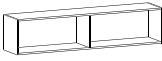
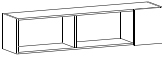
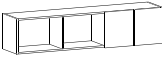
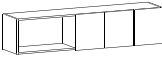
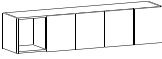
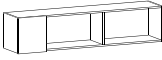
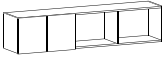
	model number	description	d	w	h	freight	list \$ zone 1	list \$ zone 2
<b>at reach storage units</b>								
	30-AR60-GDO	stanchion supported at reach storage, left metal framed glass door, open	16	60	17	class cwt lb cu ft	969	1,047
	30-AR60-4D	stanchion supported at reach storage, 4 wood doors	16	60	17	class cwt lb cu ft	1,330	1,436
	30-AR60-4GD	stanchion supported at reach storage 4 metal framed glass doors	16	60	17	class cwt lb cu ft	1,530	1,652
	30-AR74-O	stanchion supported at reach storage open	16	74	17	class cwt lb cu ft	1,167	1,260
	30-AR74-OD	stanchion supported at reach storage open, wood door right	16	74	17	class cwt lb cu ft	1,304	1,408
	30-AR74-O2D	stanchion supported at reach storage, open, 2 wood doors right	16	74	17	class cwt lb cu ft	1,441	1,556
	30-AR74-O3D	stanchion supported at reach storage, open, 3 wood doors right	16	74	17	class cwt lb cu ft	1,578	1,704
	30-AR74-O4D	stanchion supported at reach storage, open, 4 wood doors right	16	74	17	class cwt lb cu ft	1,715	1,852
	30-AR74-DO	stanchion supported at reach storage left wood door, open	16	74	17	class cwt lb cu ft	1,304	1,408
	30-AR74-2DO	stanchion supported at reach storage, left 2 wood doors, open	16	74	17	class cwt lb cu ft	1,441	1,556

cabinet  
finishes

2ML-W Natural maple  
3ML-W Light maple  
4ML-W Medium maple  
5ML-W Cherry maple

1CM-W Coffee on maple  
2UM-W Umber on maple  
3SM-W Shadow on maple



	model number	description	d	w	h	freight	list \$ zone 1	list \$ zone 2
<b>at reach storage units</b>								
	30-AR74-3DO	stanchion supported at reach storage, left 3 wood doors, open	16	74	17	class cwt lb cu ft	1,578	1,704
	30-AR74-4DO	stanchion supported at reach storage, left 4 wood doors, open	16	74	17	class cwt lb cu ft	1,715	1,852
	30-AR74-OGD	stanchion supported at reach storage open, metal framed glass door right	16	74	17	class cwt lb cu ft	1,354	1,462
	30-AR74-O2GD	stanchion supported at reach storage open, 2 metal framed glass door right	16	74	17	class cwt lb cu ft	1,541	1,664
	30-AR74-O3GD	stanchion supported at reach storage open, 3 metal framed glass doors right	16	74	17	class cwt lb cu ft	1,728	1,866
	30-AR74-O4GD	stanchion supported at reach storage open, 4 metal framed glass doors right	16	74	17	class cwt lb cu ft	1,915	2,068
	30-AR74-GDO	stanchion supported at reach storage, left metal framed glass door, open	16	74	17	class cwt lb cu ft	1,354	1,462
	30-AR74-2GDO	stanchion supported at reach storage, left 2 metal framed glass door, open	16	74	17	class cwt lb cu ft	1,541	1,664
	30-AR74-3GDO	stanchion supported at reach storage , left 3 metal framed glass doors, open	16	74	17	class cwt lb cu ft	1,728	1,866
	30-AR74-4GDO	stanchion supported at reach storage , left 4 metal framed glass doors, open	16	74	17	class cwt lb cu ft	1,915	2,068



cabinet finishes

2ML-W Natural maple  
3ML-W Light maple  
4ML-W Medium maple  
5ML-W Cherry maple

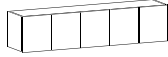
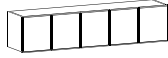
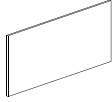
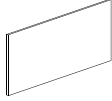

1CM-W Coffee on maple  
2UM-W Umber on maple  
3SM-W Shadow on maple

saleer 3000/3100/3200



	model number	description	d	w	h	freight	list \$ zone 1	list \$ zone 2
<b>at reach storage units</b>								
	30-AR74-5D	stanchion supported at reach storage, 5 wood doors	16	74	17	class cwt lb cu ft	1,852	1,999
	30-AR74-5GL	stanchion supported at reach storage 5 metal framed glass doors	16	74	17	class cwt lb cu ft	2,101	2,269
<b>tack panel</b>								
	30-30TP	30" Backside tackpanel for at reach storage unit	16	30		class cwt lb cu ft	g1 534 g2 538 g3 550 g4 555 g5 564 g6 570 g7 576	g1 534 g2 538 g3 550 g4 555 g5 564 g6 570 g7 576
	30-45TP	45" Backside tackpanel for at reach storage unit	16	45		class cwt lb cu ft	g1 575 g2 579 g3 592 g4 597 g5 605 g6 612 g7 618	g1 575 g2 579 g3 592 g4 597 g5 605 g6 612 g7 618
	30-60TP	60" Backside tackpanel for at reach storage unit	16	60		class cwt lb cu ft	g1 635 g2 642 g3 656 g4 666 g5 676 g6 683 g7 693	g1 635 g2 642 g3 656 g4 666 g5 676 g6 683 g7 693
	30-72TP	72" Backside tackpanel for at reach storage unit	16	72		class cwt lb cu ft	g1 656 g2 664 g3 684 g4 693 g5 706 g6 717 g7 725	g1 656 g2 664 g3 684 g4 693 g5 706 g6 717 g7 725

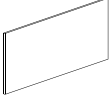
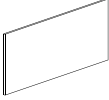

	model number	description	d	w	h	freight	list \$ zone 1	list \$ zone 2
<b>writing panel</b>								
	<b>30-30-WS</b>	30" Backside writing panel for at reach storage unit	16	30		class cwt lb cu ft	<b>165</b>	<b>165</b>
	<b>30-45WS</b>	45" Backside writing panel for at reach storage unit	16	45		class cwt lb cu ft	<b>165</b>	<b>165</b>
	<b>30-60WS</b>	60" Backside writing panel for at reach storage unit	16	60		class cwt lb cu ft	<b>225</b>	<b>225</b>
	<b>30-72WS</b>	72" Backside writing panel for at reach storage unit	16	72		class cwt lb cu ft	<b>264</b>	<b>264</b>

saleer  
3000/3100/3200

cabinet finishes

<b>2ML-W</b> Natural maple	<b>1CM-W</b> Coffee on maple
<b>3ML-W</b> Light maple	<b>2UM-W</b> Umber on maple
<b>4ML-W</b> Medium maple	<b>3SM-W</b> Shadow on maple
<b>5ML-W</b> Cherry maple	

# inwood

OFFICE  
ENVIRONMENTS

## price list

effective 01 january 2012

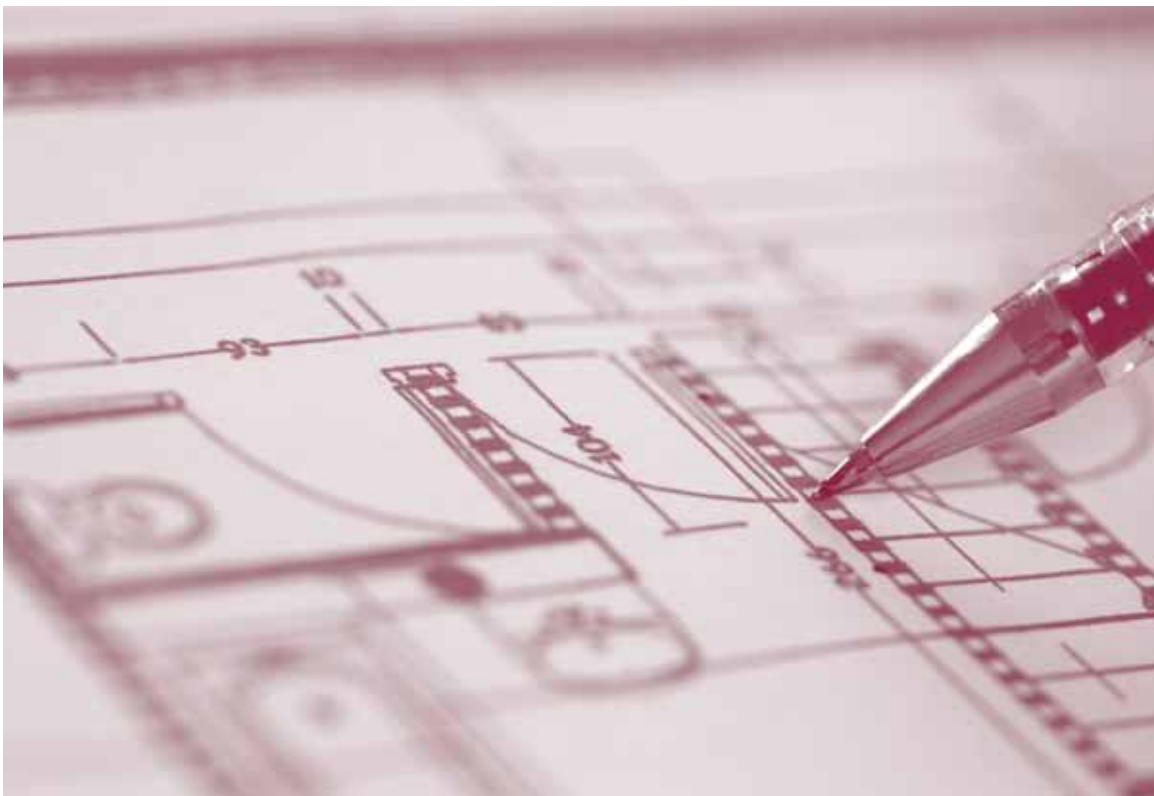

account # \_\_\_\_\_  
discount \_\_\_\_\_  
zone \_\_\_\_\_  
c.s.r. \_\_\_\_\_  
sales rep. \_\_\_\_\_

progeny  
2600

[click here for warranty  
and terms information](#)

zones one and two



# inwood

OFFICE  
ENVIRONMENTS

---



progeny  
2600

### progeny 2600 series specifications

#### materials:

All wood is thoroughly air and kiln dried to a moisture content not to exceed 8% at the time of assembly

#### veneers:

All exposed surfaces are plain sliced cherry. Veneers are carefully slip-matched and balanced. All drawer fronts, doors, end panels, and modesty panels are vertical grain.

#### top work surfaces:

Wood veneer tops are 1 1/16" thick, 3-ply construction; consisting of 1/40" thick cherry veneer work surface and a Gator-ply backing. The top core material is a medium density fiberboard, with a reversed softened edge. Detail on all four sides on desks and front and back edges on other pieces.

#### modesty panels:

Recessed 3/4" thick, 3-ply construction with a vertical veneer on exposed surfaces and a 45 lb density particle board core or perforated 18 gauge steel. ChemCast is a cell cast acrylic offered in clear (P-95). It is a light weight thermoplastic material.

#### construction:

Uses a mortise and tenon and glue to join pedestal sides and back. All joints are reinforced with glue blocks. All pedestals have box drawers and/or file drawers with a brushed chrome pull standard. Each pedestal has a lock and is keyed alike. All bookcase shelves are standard 3/4" thick.

#### drawers:

Drawer fronts are 3/4" thick, 3-ply construction with vertical book-matched veneer. Drawer edges are rounded with matching cherry colored foil on all edges. All drawer sides and backs are plywood, dovetailed front and back with 3-ply drawer bottoms. Drawer bottoms are framed on four sides and stapled from the bottom side. Drawer interiors are finished with a clear coat sealer to prevent swelling or shrinkage. Box drawers have a high grade sterling metal ball-bearing drawer suspension. File drawers have a high grade sterling metal ball bearing full progressive suspension and are equipped with metal rods for hanging file folders. All drawers have smooth quiet operation.  
*NOTE: Optional center drawers available*

#### inside drawer dimensions:

box drawers: 4" H x 12 1/8" W x 22 1/8" L  
4" H x 14 5/8" W x 22 1/8" L  
file drawers: 9 1/2" H x 14 5/8" W x 15 9/16" L  
9 1/2" H x 14 5/8" W x 25 3/8" L  
lateral files: 9 1/2" H x 32 5/8" W x 16" L

#### locking:

Each pedestal has its own lock and is keyed alike on each unit. Each unit is equipped with two keys. Units may be keyed alike in groups (per office, if requested) for an additional charge of \$37 list per unit.

#### finish:

All Inwood finishes are catalyzed varnish finish. Our multi-step satin finishes leave an open grain natural look to the furniture. Available in following finishes (1NC) natural cherry on cherry, (2HC) honey cherry on cherry, and (9BC) burgundy cherry on cherry.

#### grommets:

Standard silver grommet. Optional black available (no upcharge)

### modesty and overhead door options:



chemcast

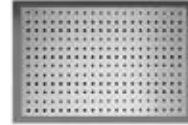

veneer



**progeny**

**desks**

letter  
front to back

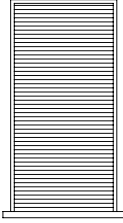

letter  
side to side

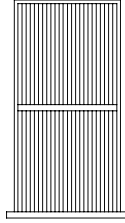

letter/legal  
combination

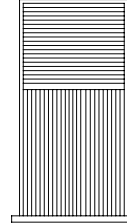

**returns**

letter  
front to back

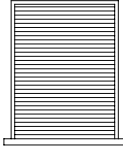

letter  
side to side

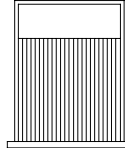

**credenzas**

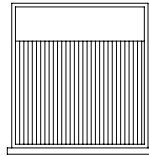

**lateral files**

legal  
front to back

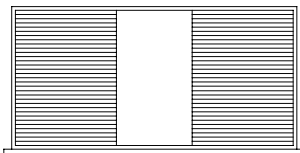

letter  
side to side

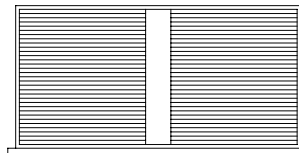

legal  
side to side

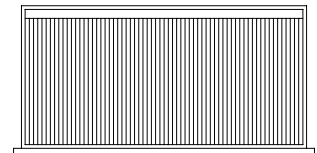
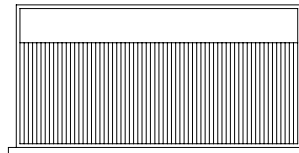

## FBT2672-AVM-9BC-W

unit identification (type), top dimension - chassis option - chassis & top finish - top material

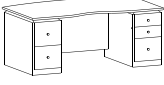
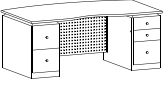
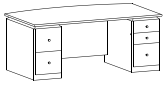
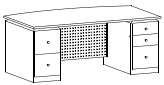
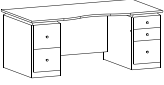
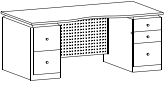
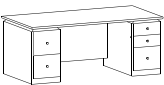
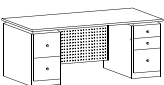
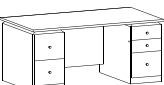
	model number	description			list \$ zone 1	list \$ zone 2
	<b>FBT2672-AVM</b> - __ - __ - __	bow front double pedestal desk inside arc on user side left file/file pedestal right box/box/file pedestal venerer modesty panel  <i>CHEMCAST MODESTY (LIST) \$410</i>	42 72 29 <i>APPROCH: 10"</i> <i>KNEESPACE: 39.5"</i>	class 125 cwt 330 lb cu ft 55	<b>4,767</b>	<b>5,149</b>
	<b>FBT2672-AMM</b> - __ - __ - __	bow front double pedestal desk inside arc on user side left file/file pedestal right box/box/file pedestal metal modesty panel  <i>CHEMCAST MODESTY (LIST) \$410</i>	42 72 29 <i>APPROCH: 10"</i> <i>KNEESPACE: 39.5"</i>	class 125 cwt 320 lb cu ft 55	<b>4,767</b>	<b>5,149</b>
	<b>FBT2672-VM</b> - __ - __ - __	bow front double pedestal desk left file/file pedestal right box/box/file pedestal venerer modesty panel  <i>CHEMCAST MODESTY (LIST) \$410</i>	42 72 29 <i>APPROCH: 10"</i> <i>KNEESPACE: 39.5"</i>	class 125 cwt 335 lb cu ft 55	<b>4,484</b>	<b>4,842</b>
	<b>FBT2672-MM</b> - __ - __ - __	bow front double pedestal desk left file/file pedestal right box/box/file pedestal metal modesty panel  <i>CHEMCAST MODESTY (LIST) \$410</i>	42 72 29 <i>APPROCH: 10"</i> <i>KNEESPACE: 39.5"</i>	class 125 cwt 325 lb cu ft 55	<b>4,484</b>	<b>4,842</b>
	<b>F2672-AVM</b> - __ - __ - __	double pedestal desk inside arc on user side left file/file pedestal right box/box/file pedestal venerer modesty panel  <i>CHEMCAST MODESTY (LIST) \$410</i>	36 72 29 <i>APPROCH: 4"</i> <i>KNEESPACE: 39.5"</i>	class 125 cwt 320 lb cu ft 53	<b>4,346</b>	<b>4,694</b>
	<b>F2672-AMM</b> - __ - __ - __ Quick Ship available in #2 HC honey cherry finish	double pedestal desk inside arc on user side left file/file pedestal right box/box/file pedestal metal modesty panel  <i>CHEMCAST MODESTY (LIST) \$410</i>	36 72 29 <i>APPROCH: 4"</i> <i>KNEESPACE: 39.5"</i>	class 125 cwt 310 lb cu ft 53	<b>4,346</b>	<b>4,694</b>
	<b>F2672-VM</b> - __ - __ - __	double pedestal desk left file/file pedestal right box/box/file pedestal venerer modesty panel  <i>CHEMCAST MODESTY (LIST) \$410</i>	36 72 29 <i>APPROCH: 4"</i> <i>KNEESPACE: 39.5"</i>	class 125 cwt 325 lb cu ft 53	<b>4,063</b>	<b>4,388</b>
	<b>F2672-MM</b> - __ - __ - __	double pedestal desk left file/file pedestal right box/box/file pedestal metal modesty panel  <i>CHEMCAST MODESTY (LIST) \$410</i>	36 72 29 <i>APPROCH: 4"</i> <i>KNEESPACE: 39.5"</i>	class 125 cwt 315 lb cu ft 53	<b>4,063</b>	<b>4,388</b>
	<b>F2666-VM</b> - __ - __ - __	double pedestal desk left file/file pedestal right box/box/file pedestal venerer modesty panel  <i>CHEMCAST MODESTY (LIST) \$336</i>	36 66 29 <i>APPROCH: 4"</i> <i>KNEESPACE: 33.5"</i>	class 125 cwt 315 lb cu ft 48	<b>4,051</b>	<b>4,376</b>

[ QS ]

progeny  
2600

top

W veneer top

**progeny** modesty options:  
CM - chemcast modesty (P-95)  
MM - graphite metal modesty  
SM - silver metal modesty  
VM - veneer modesty

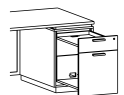



edge



to add laptop ped in any desk (min 36" deep) add \$1162 zone 1 \ \$1255 zone 2 list upcharge

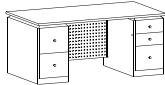
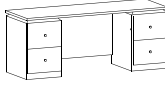
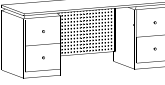
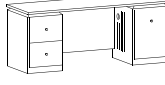
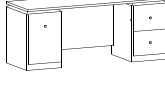
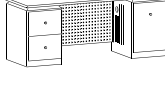
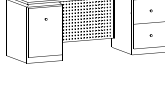

	model number	description	d w h	freight	list \$ zone 1	list \$ zone 2
	<b>F2666-MM</b> - _ - _	double pedestal desk left file/file pedestal right box/box/file pedestal metal modesty panel  <i>CHEMCAST MODESTY (LIST) \$336</i>	36 66 29 <i>APPROCH: 4"</i> <i>KNEESPACE: 33.5"</i>	class 125 cwt 305 lb cu ft 48	<b>4,051</b>	<b>4,376</b>
	<b>CR2672-VM</b> - _ - _	kneespace credenza left and right file/file pedestal veneer modesty panel  <i>CHEMCAST MODESTY (LIST) \$434</i>	24 72 29 <i>KNEESPACE: 36"</i>	class 125 cwt 275 lb cu ft 35	<b>3,639</b>	<b>3,929</b>
<b>[ QS ]</b> 	<b>CR2672-MM</b> - _ - _ Quick Ship available in #2 HC honey cherry finish	kneespace credenza left and right file/file pedestal metal modesty panel  <i>CHEMCAST MODESTY (LIST) \$434</i>	24 72 29 <i>KNEESPACE: 36"</i>	class 125 cwt 265 lb cu ft 35	<b>3,639</b>	<b>3,929</b>
	<b>CR2672R-CVM</b> - _ - _	kneespace credenza left file/file and right CPU pedestal veneer modesty panel  <i>CHEMCAST MODESTY (LIST) \$434</i>	24 72 29 <i>KNEESPACE: 36"</i>	class 125 cwt 275 lb cu ft 35	<b>3,436</b>	<b>3,711</b>
	<b>CR2672L-CVM</b> - _ - _	kneespace credenza right file/file and left CPU pedestal veneer modesty panel  <i>CHEMCAST MODESTY (LIST) \$434</i>	24 72 29 <i>KNEESPACE: 36"</i>	class 125 cwt 275 lb cu ft 35	<b>3,436</b>	<b>3,711</b>
	<b>CR2672R-CMM</b> - _ - _	kneespace credenza left file/file and right CPU pedestal metal modesty panel  <i>CHEMCAST MODESTY (LIST) \$434</i>	24 72 29 <i>KNEESPACE: 36"</i>	class 125 cwt 265 lb cu ft 35	<b>3,436</b>	<b>3,711</b>
	<b>CR2672L-CMM</b> - _ - _	kneespace credenza right file/file and left CPU pedestal metal modesty panel  <i>CHEMCAST MODESTY (LIST) \$434</i>	24 72 29 <i>KNEESPACE: 36"</i>	class 125 cwt 265 lb cu ft 35	<b>3,436</b>	<b>3,711</b>
	<b>CR2672D-VM</b> - _ - _	storage credenza left and right file/file pedestal double hinged door center 1 adjustable shelf  <i>EXTRA SHELF (EACH) \$92</i>	24 72 29	class 125 cwt 350 lb cu ft 35	<b>4,293</b>	<b>4,634</b>
	<b>CR2672HD-VM</b> - _ - _	storage credenza double hinged door center 3 adjustable shelves  <i>EXTRA SHELF (EACH) \$92</i>	24 72 29	class 125 cwt 350 lb cu ft 35	<b>4,024</b>	<b>4,366</b>



veneer  
tops only

**1NC-W** natural cherry on cherry  
**2HC-W** honey cherry on cherry  
**9BC-W** burgundy cherry on cherry

to add laptop ped in any desk (min 36" deep) add \$1162 zone 1 \ \$1255 zone 2 list upcharge

progeny  
2600

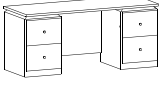
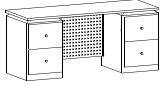
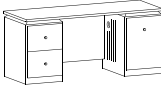
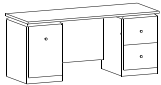
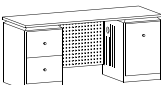
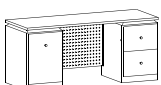
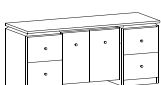

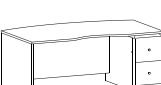
	model number	description			list \$ zone 1	list \$ zone 2
	CR2666-VM - _ - _	kneespace credenza left and right file/file pedestal venerer modesty panel  <i>CHEMCAST MODESTY (LIST) \$300</i>	24 66 29 <i>KNEESPACE: 30"</i>	class 125 cwt 270 lb cu ft 30	3,528	3,814
	CR2666-MM - _ - _	kneespace credenza left and right file/file pedestal metal modesty panel  <i>CHEMCAST MODESTY (LIST) \$300</i>	24 66 29 <i>KNEESPACE: 30"</i>	class 125 cwt 260 lb cu ft 30	3,528	3,814
	CR2666R-CVM - _ - _	kneespace credenza left file/file and right CPU pedestal venerer modesty panel  <i>CHEMCAST MODESTY (LIST) \$300</i>	24 66 29 <i>KNEESPACE: 30"</i>	class 125 cwt 270 lb cu ft 30	3,396	3,667
	CR2666L-CVM - _ - _	kneespace credenza right file/file and left CPU pedestal venerer modesty panel  <i>CHEMCAST MODESTY (LIST) \$300</i>	24 66 29 <i>KNEESPACE: 30"</i>	class 125 cwt 270 lb cu ft 30	3,396	3,667
	CR2666R-CMM - _ - _	kneespace credenza left file/file and right CPU pedestal metal modesty panel  <i>CHEMCAST MODESTY (LIST) \$300</i>	24 66 29 <i>KNEESPACE: 30"</i>	class 125 cwt 260 lb cu ft 30	3,396	3,667
	CR2666L-CMM - _ - _	kneespace credenza right file/file and left CPU pedestal metal modesty panel  <i>CHEMCAST MODESTY (LIST) \$300</i>	24 66 29 <i>KNEESPACE: 30"</i>	class 125 cwt 260 lb cu ft 30	3,396	3,667
	CR2666D-VM - _ - _	storage credenza left and right file/file pedestal double hinged door center 1 adjustable shelf  <i>EXTRA SHELF (EACH) \$92</i>	24 66 29	class 125 cwt 335 lb cu ft 30	4,238	4,576
	CR2666HD-VM - _ - _	storage credenza left and right single hinged door double hinged door center three adjustable shelves  <i>EXTRA SHELF (EACH) \$92</i>	24 66 29	class 125 cwt 350 lb cu ft 35	3,968	4,304
	DBT2672R-AVM - _ - _	bow front single pedestal desk inside arc on user side right file/file pedestal venerer modesty panel  <i>CHEMCAST MODESTY (LIST) \$780</i>	42 72 29 <i>APPROACH: 10"</i> <i>KNEESPACE: 54.5"</i>	class 125 cwt 275 lb cu ft 55	4,499	4,859

top

W veneer top

**progeny** modesty options:  
CM - chemcast modesty (P-95)  
MM - graphite metal modesty  
SM - silver metal modesty  
VM - veneer modesty

edge





	model number	description	d w h	freight	list \$ zone 1	list \$ zone 2
	<b>DBT2672L-AVM -</b> - - -	bow front single pedestal desk inside arc on user side left file/file pedestal veneer modesty panel  <i>CHEMCAST MODESTY (LIST) \$780</i>	42 72 29 <i>APPROCH: 10"</i> <i>KNEESPACE: 54.5"</i>	class 125 cwt 275 lb cu ft 55	<b>4,499</b>	<b>4,859</b>
	<b>DBT2672R-AMM -</b> - - -	bow front single pedestal desk inside arc on user side right file/file pedestal metal modesty panel  <i>CHEMCAST MODESTY (LIST) \$780</i>	42 72 29 <i>APPROCH: 10"</i> <i>KNEESPACE: 54.5"</i>	class 125 cwt 265 lb cu ft 55	<b>4,499</b>	<b>4,859</b>
	<b>DBT2672L-AMM -</b> - - -	bow front single pedestal desk inside arc on user side left file/file pedestal metal modesty panel  <i>CHEMCAST MODESTY (LIST) \$780</i>	42 72 29 <i>APPROCH: 10"</i> <i>KNEESPACE: 54.5"</i>	class 125 cwt 265 lb cu ft 55	<b>4,499</b>	<b>4,859</b>
	<b>DBT2672R-VM -</b> - - -	bow front single pedestal desk right file/file pedestal veneer modesty panel  <i>CHEMCAST MODESTY (LIST) \$780</i>	42 72 29 <i>APPROCH: 10"</i> <i>KNEESPACE: 54.5"</i>	class 125 cwt 280 lb cu ft 55	<b>4,218</b>	<b>4,556</b>
	<b>DBT2672L-VM -</b> - - -	bow front single pedestal desk left file/file pedestal veneer modesty panel  <i>CHEMCAST MODESTY (LIST) \$780</i>	42 72 29 <i>APPROCH: 10"</i> <i>KNEESPACE: 54.5"</i>	class 125 cwt 280 lb cu ft 55	<b>4,218</b>	<b>4,556</b>
	<b>DBT2672R-MM -</b> - - -	bow front single pedestal desk right file/file pedestal metal modesty panel  <i>CHEMCAST MODESTY (LIST) \$780</i>	42 72 29 <i>APPROCH: 10"</i> <i>KNEESPACE: 54.5"</i>	class 125 cwt 270 lb cu ft 55	<b>4,218</b>	<b>4,556</b>
	<b>DBT2672L-MM -</b> - - -	bow front single pedestal desk left file/file pedestal metal modesty panel  <i>CHEMCAST MODESTY (LIST) \$780</i>	42 72 29 <i>APPROCH: 10"</i> <i>KNEESPACE: 54.5"</i>	class 125 cwt 270 lb cu ft 55	<b>4,218</b>	<b>4,556</b>
	<b>DBT2672R-3DVM -</b> - - -	bow front single pedestal desk right box/box/file pedestal veneer modesty panel  <i>CHEMCAST MODESTY (LIST) \$780</i>	42 72 29 <i>APPROCH: 10"</i> <i>KNEESPACE: 54.5"</i>	class 125 cwt 280 lb cu ft 55	<b>4,482</b>	<b>4,818</b>
	<b>DBT2672L-3DVM -</b> - - -	bow front single pedestal desk left box/box/file pedestal veneer modesty panel  <i>CHEMCAST MODESTY (LIST) \$780</i>	42 72 29 <i>APPROCH: 10"</i> <i>KNEESPACE: 54.5"</i>	class 125 cwt 280 lb cu ft 55	<b>4,482</b>	<b>4,818</b>

veneer  
tops only



**1NC-W**natural cherry on cherry  
**2HC-W**honey cherry on cherry  
**9BC-W**burgundy cherry on cherry

fake front (single ped) \$615 list upcharge

progeny  
2600

## FBT2672-AVM-9BC-W

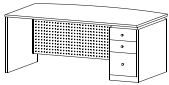
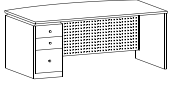
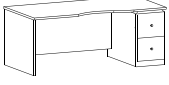
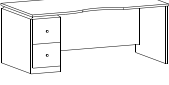
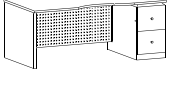
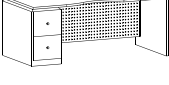
unit identification (type), top dimension - chassis option - chassis & top finish - top material

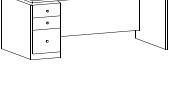
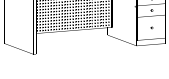
	model number	description			list \$ zone 1	list \$ zone 2
	<b>DBT2672R-3DMM</b> - -- --	bow front single pedestal desk right box/box/file pedestal metal modesty panel  <i>CHEMCAST MODESTY (LIST) \$780</i>	42 72 29 <i>APPROCH: 10"</i> <i>KNEESPACE: 54.5"</i>	class 125 cwt 270 lb cu ft 55	<b>4,482</b>	<b>4,818</b>
	<b>DBT2672L-3DMM</b> - -- --	bow front single pedestal desk left box/box/file pedestal metal modesty panel  <i>CHEMCAST MODESTY (LIST) \$780</i>	42 72 29 <i>APPROCH: 10"</i> <i>KNEESPACE: 54.5"</i>	class 125 cwt 270 lb cu ft 55	<b>4,482</b>	<b>4,818</b>
	<b>D2672R-AVM</b> - -- --	single pedestal desk inside arc on user side right file/file pedestal veneer modesty panel  <i>CHEMCAST MODESTY (LIST) \$780</i>	36 72 29 <i>APPROCH: 4"</i> <i>KNEESPACE: 54.5"</i>	class 125 cwt 265 lb cu ft 53	<b>4,082</b>	<b>4,408</b>
	<b>D2672L-AVM</b> - -- --	single pedestal desk inside arc on user side left file/file pedestal veneer modesty panel  <i>CHEMCAST MODESTY (LIST) \$780</i>	36 72 29 <i>APPROCH: 4"</i> <i>KNEESPACE: 54.5"</i>	class 125 cwt 265 lb cu ft 53	<b>4,082</b>	<b>4,408</b>
	<b>D2672R-AMM</b> - -- --	single pedestal desk inside arc on user side right file/file pedestal metal modesty panel  <i>CHEMCAST MODESTY (LIST) \$780</i>	36 72 29 <i>APPROCH: 4"</i> <i>KNEESPACE: 54.5"</i>	class 125 cwt 255 lb cu ft 53	<b>4,082</b>	<b>4,408</b>
	<b>D2672L-AMM</b> - -- --	single pedestal desk inside arc on user side left file/file pedestal metal modesty panel  <i>CHEMCAST MODESTY (LIST) \$780</i>	36 72 29 <i>APPROCH: 4"</i> <i>KNEESPACE: 54.5"</i>	class 125 cwt 255 lb cu ft 53	<b>4,082</b>	<b>4,408</b>
	<b>D2672R-3DAVM</b> - -- --	single pedestal desk inside arc on user side right box/box/file pedestal veneer modesty panel  <i>CHEMCAST MODESTY (LIST) \$780</i>	36 72 29 <i>APPROCH: 4"</i> <i>KNEESPACE: 54.5"</i>	class 125 cwt 265 lb cu ft 53	<b>4,343</b>	<b>4,671</b>
	<b>D2672L-3DAVM</b> - -- --	single pedestal desk inside arc on user side left box/box/file pedestal veneer modesty panel  <i>CHEMCAST MODESTY (LIST) \$780</i>	36 72 29 <i>APPROCH: 4"</i> <i>KNEESPACE: 54.5"</i>	class 125 cwt 265 lb cu ft 53	<b>4,343</b>	<b>4,671</b>
	<b>D2672R-3DAMM</b> - -- --	single pedestal desk inside arc on user side right box/box/file pedestal metal modesty panel  <i>CHEMCAST MODESTY (LIST) \$780</i>	36 72 29 <i>APPROCH: 4"</i> <i>KNEESPACE: 54.5"</i>	class 125 cwt 255 lb cu ft 53	<b>4,343</b>	<b>4,671</b>

top

W veneer top

**progeny** modesty options:  
CM - chemcast modesty (P-95)  
MM - graphite metal modesty  
SM - silver metal modesty  
VM - veneer modesty

edge



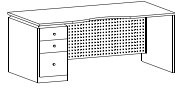

**model number**  
D2672L-3DAMM - - -

**description**  
single pedestal desk  
inside arc on user side  
left box/box/file pedestal  
metal modesty panel  
  
CHEMCAST MODESTY (LIST) \$780

**d w h**  
36 72 29  
APPROCH: 4"  
KNEESPACE: 54.5"

**freight**  
class 125  
cwt 255 lb  
cu ft 53

**list \$ zone 1**  
4,343

**list \$ zone 2**  
4,671

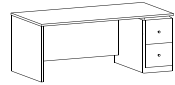

**D2672R-VM - - -**

single pedestal desk  
right file/file pedestal  
veneer modesty panel  
  
CHEMCAST MODESTY (LIST) \$780

36 72 29  
APPROCH: 4"  
KNEESPACE: 54.5"

class 125  
cwt 270 lb  
cu ft 53

**3,800**

**4,107**

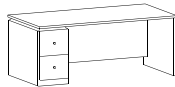

**D2672L-VM - - -**

single pedestal desk  
left file/file pedestal  
veneer modesty panel  
  
CHEMCAST MODESTY (LIST) \$780

36 72 29  
APPROCH: 4"  
KNEESPACE: 54.5"

class 125  
cwt 270 lb  
cu ft 53

**3,800**

**4,107**

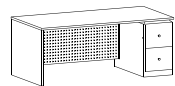

**D2672R-MM - - -**

single pedestal desk  
right file/file pedestal  
metal modesty panel  
  
CHEMCAST MODESTY (LIST) \$780

36 72 29  
APPROCH: 4"  
KNEESPACE: 54.5"

class 125  
cwt 260 lb  
cu ft 53

**3,800**

**4,107**

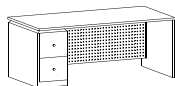

**D2672L-MM - - -**

single pedestal desk  
left file/file pedestal  
metal modesty panel  
  
CHEMCAST MODESTY (LIST) \$780

36 72 29  
APPROCH: 4"  
KNEESPACE: 54.5"

class 125  
cwt 260 lb  
cu ft 53

**3,800**

**4,107**

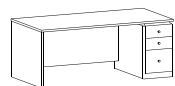

**D2672R-3DVM - - -**

single pedestal desk  
right box/box/file pedestal  
veneer modesty panel  
  
CHEMCAST MODESTY (LIST) \$780

36 72 29  
APPROCH: 4"  
KNEESPACE: 54.5"

class 125  
cwt 270 lb  
cu ft 53

**4,062**

**4,369**



**D2672L-3DVM - - -**

single pedestal desk  
left box/box/file pedestal  
veneer modesty panel  
  
CHEMCAST MODESTY (LIST) \$780

36 72 29  
APPROCH: 4"  
KNEESPACE: 54.5"

class 125  
cwt 270 lb  
cu ft 53

**4,062**

**4,369**

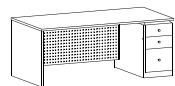

**D2672R-3DMM - - -**

single pedestal desk  
right box/box/file pedestal  
metal modesty panel  
  
CHEMCAST MODESTY (LIST) \$780

36 72 29  
APPROCH: 4"  
KNEESPACE: 54.5"

class 125  
cwt 260 lb  
cu ft 53

**4,062**

**4,369**

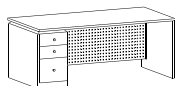

**D2672L-3DMM - - -**

single pedestal desk  
left box/box/file pedestal  
metal modesty panel  
  
CHEMCAST MODESTY (LIST) \$780

36 72 29  
APPROCH: 4"  
KNEESPACE: 54.5"

class 125  
cwt 260 lb  
cu ft 53

**4,062**

**4,369**

**veneer**  
tops only

**1NC-W**natural cherry on cherry  
**2HC-W**honey cherry on cherry  
**9BC-W**burgundy cherry on cherry

fake front (single ped) \$615 list upcharge

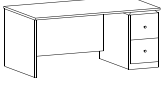
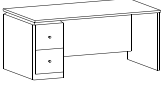
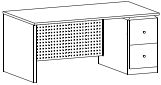
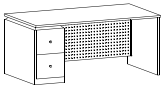
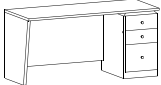
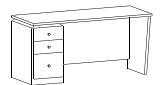
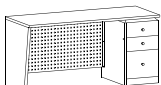
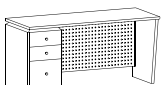
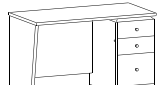
	model number	description			list \$ zone 1	list \$ zone 2
	D2666R-VM - _ - _	single pedestal desk right file/file pedestal veneer modesty panel  <i>CHEMCAST MODESTY (LIST) \$514</i>	36 66 29 <i>APPROCH: 4"</i> <i>KNEESPACE: 48.5"</i>	class 125 cwt 260 lb cu ft 48	3,689	3,985
	D2666L-VM - _ - _	single pedestal desk left file/file pedestal veneer modesty panel  <i>CHEMCAST MODESTY (LIST) \$514</i>	36 66 29 <i>APPROCH: 4"</i> <i>KNEESPACE: 48.5"</i>	class 125 cwt 260 lb cu ft 48	3,689	3,985
	D2666R-MM - _ - _	single pedestal desk right file/file pedestal metal modesty panel  <i>CHEMCAST MODESTY (LIST) \$514</i>	36 66 29 <i>APPROCH: 4"</i> <i>KNEESPACE: 48.5"</i>	class 125 cwt 250 lb cu ft 48	3,689	3,985
	D2666L-MM - _ - _	single pedestal desk left file/file pedestal metal modesty panel  <i>CHEMCAST MODESTY (LIST) \$514</i>	36 66 29 <i>APPROCH: 4"</i> <i>KNEESPACE: 48.5"</i>	class 125 cwt 250 lb cu ft 48	3,689	3,985
	D2660R-VM - _ - _	single pedestal modular desk right box/box/file pedestal veneer modesty panel use freestanding or with CU units  <i>CHEMCAST MODESTY (LIST) \$514</i>	24 60 29 <i>KNEESPACE: 42.5"</i>	class 125 cwt 165 lb cu ft 29	3,246	3,505
	D2660L-VM - _ - _	single pedestal modular desk left box/box/file pedestal veneer modesty panel use freestanding or with CU units  <i>CHEMCAST MODESTY (LIST) \$514</i>	24 60 29 <i>KNEESPACE: 42.5"</i>	class 125 cwt 165 lb cu ft 29	3,246	3,505
	D2660R-MM - _ - _	single pedestal modular desk right box/box/file pedestal metal modesty panel use freestanding or with CU units  <i>CHEMCAST MODESTY (LIST) \$514</i>	24 60 29 <i>KNEESPACE: 42.5"</i>	class 125 cwt 160 lb cu ft 29	3,246	3,505
	D2660L-MM - _ - _	single pedestal modular desk left box/box/file pedestal metal modesty panel use freestanding or with CU units  <i>CHEMCAST MODESTY (LIST) \$514</i>	24 60 29 <i>KNEESPACE: 42.5"</i>	class 125 cwt 160 lb cu ft 29	3,246	3,505
	D2648R-VM - _ - _	single pedestal modular desk right box/box/file pedestal veneer modesty panel use freestanding or with CU units  <i>CHEMCAST MODESTY (LIST) \$514</i>	24 48 29 <i>KNEESPACE: 30.5"</i>	class 125 cwt 160 lb cu ft 22	2,673	2,887

top

W veneer top

**progeny** modesty options:  
CM - chemcast modesty (P-95)  
MM - graphite metal modesty  
SM - silver metal modesty  
VM - veneer modesty

edge





**model number**  
D2648L-VM - \_ - \_

**description**  
single pedestal modular desk  
left box/box/file pedestal  
veneer modesty panel  
use freestanding or with CU units  
  
CHEMCAST MODESTY (LIST) \$514

**d w h**  
24 48 29  
KNEESPACE: 30.5"

**freight**  
class 125  
cwt 160 lb  
cu ft 22

**list \$ zone 1**  
2,673

**list \$ zone 2**  
2,887

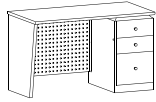

**model number**  
D2648R-MM - \_ - \_

**description**  
single pedestal modular desk  
right box/box/file pedestal  
metal modesty panel  
use freestanding or with CU units  
  
CHEMCAST MODESTY (LIST) \$514

**d w h**  
24 48 29  
KNEESPACE: 30.5"

**freight**  
class 125  
cwt 155 lb  
cu ft 22

**list \$ zone 1**  
2,673

**list \$ zone 2**  
2,887

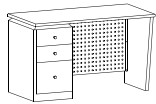

**model number**  
D2648L-MM - \_ - \_

**description**  
single pedestal modular desk  
left box/box/file pedestal  
metal modesty panel  
use freestanding or with CU units  
  
CHEMCAST MODESTY (LIST) \$514

**d w h**  
24 48 29  
KNEESPACE: 30.5"

**freight**  
class 125  
cwt 155 lb  
cu ft 22

**list \$ zone 1**  
2,673

**list \$ zone 2**  
2,887

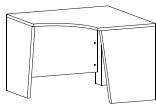

**model number**  
CU2642-AVM - \_ - \_

**description**  
corner CRT  
arc edge  
veneer modesty panel  
  
CHEMCAST MODESTY (LIST) \$677

**d w h**  
24 42 29  
KNEESPACE: 27"

**freight**  
class 85  
cwt 150 lb  
cu ft 9

**list \$ zone 1**  
2,727

**list \$ zone 2**  
2,945

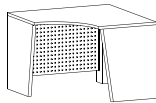

**model number**  
CU2642-AMM - \_ - \_

**description**  
corner CRT  
arc edge  
metal modesty panel  
  
CHEMCAST MODESTY (LIST) \$677

**d w h**  
24 42 29  
KNEESPACE: 27"

**freight**  
class 85  
cwt 140 lb  
cu ft 9

**list \$ zone 1**  
2,727

**list \$ zone 2**  
2,945

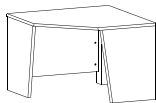

**model number**  
CU2642-VM - \_ - \_

**description**  
corner CRT  
straight edge  
veneer modesty panel  
  
CHEMCAST MODESTY (LIST) \$677

**d w h**  
24 42 29  
KNEESPACE: 27"

**freight**  
class 85  
cwt 150 lb  
cu ft 9

**list \$ zone 1**  
2,443

**list \$ zone 2**  
2,642

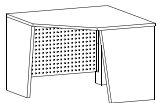

**model number**  
CU2642-MM - \_ - \_

**description**  
corner CRT  
straight edge  
metal modesty panel  
  
CHEMCAST MODESTY (LIST) \$677

**d w h**  
24 42 29  
KNEESPACE: 27"

**freight**  
class 85  
cwt 140 lb  
cu ft 9

**list \$ zone 1**  
2,443

**list \$ zone 2**  
2,642

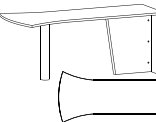

**model number**  
E2672 - \_ - \_

**description**  
double fan flare top  
'T' support end  
black support column (LB4)\*  
  
CHEMCAST MODESTY (LIST) \$410  
TO ADD A VENEER OR METAL MODESTY (LIST) \$232

**d w h**  
24-36 72 29

**freight**  
class 85  
cwt 130 lb  
cu ft 11

**list \$ zone 1**  
2,441

**list \$ zone 2**  
2,637

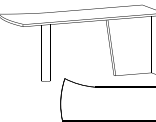

**model number**  
E2672R - \_ - \_

**description**  
single fan flare top  
'T' support end  
black support column (LB4)\*  
  
CHEMCAST MODESTY (LIST) \$410  
TO ADD A VENEER OR METAL MODESTY (LIST) \$232

**d w h**  
24-30 72 29

**freight**  
class 85  
cwt 125 lb  
cu ft 11

**list \$ zone 1**  
2,349

**list \$ zone 2**  
2,536



**veneer**  
tops only

1NC-W natural cherry on cherry  
2HC-W honey cherry on cherry  
9BC-W burgundy cherry on cherry

\* LB4 leg can be replaced with a PLB (wood leg) at no upcharge

## FBT2672-AVM-9BC-W

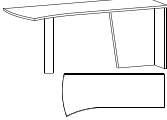
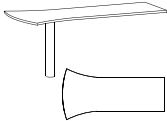
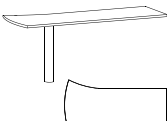
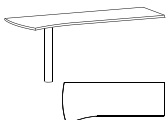
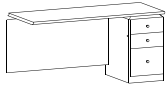
unit identification (type), top dimension - chassis option - chassis & top finish - top material

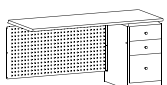
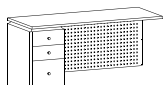
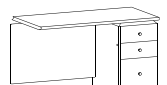
	model number	description			class	list \$ zone 1	list \$ zone 2
	E2672L - _ - _	single fan flare top 'T' support end black support column (LB4)*  <i>CHEMCAST MODESTY (LIST) \$410</i> <i>TO ADD A VENEER OR METAL MODESTY (LIST) \$232</i>	24-30	72 29	85 cwt 125 lb cu ft 11	2,349	2,536
	EM2672 - _ - _	double fan flare top black support column (LB4)* attach to another unit to form 'L'  <i>CHEMCAST MODESTY (LIST) \$410</i> <i>TO ADD A VENEER OR METAL MODESTY (LIST) \$232</i>	24-36	72 29	85 cwt 105 lb cu ft 9	2,087	2,258
	EM2672R - _ - _	single fan flare top black support column (LB4)* attach to another unit to form 'L'  <i>CHEMCAST MODESTY (LIST) \$410</i> <i>TO ADD A VENEER OR METAL MODESTY (LIST) \$232</i>	24-30	72 29	85 cwt 100 lb cu ft 9	1,950	2,106
	EM2672L - _ - _	single fan flare top black support column (LB4)* attach to another unit to form 'L'  <i>CHEMCAST MODESTY (LIST) \$410</i> <i>TO ADD A VENEER OR METAL MODESTY (LIST) \$232</i>	24-30	72 29	85 cwt 100 lb cu ft 9	1,950	2,106
	R2660R-VM - _ - _	single pedestal return right box/box/file pedestal veneer modesty panel  <i>CHEMCAST MODESTY (LIST) \$550</i>	24	60 29	125 cwt 165 lb cu ft 29	2,949	3,185
	R2660L-VM - _ - _	single pedestal return left box/box/file pedestal veneer modesty panel  <i>CHEMCAST MODESTY (LIST) \$550</i>	24	60 29	125 cwt 165 lb cu ft 29	2,949	3,185
	R2660R-MM - _ - _	single pedestal return right box/box/file pedestal metal modesty panel  <i>CHEMCAST MODESTY (LIST) \$550</i>	24	60 29	125 cwt 160 lb cu ft 29	2,949	3,185
	R2660L-MM - _ - _	single pedestal return left box/box/file pedestal metal modesty panel  <i>CHEMCAST MODESTY (LIST) \$550</i>	24	60 29	125 cwt 160 lb cu ft 29	2,949	3,185
	R2648R-VM - _ - _	single pedestal return right box/box/file pedestal veneer modesty panel  <i>CHEMCAST MODESTY (LIST) \$498</i>	24	48 29	125 cwt 160 lb cu ft 22	2,430	2,623

progeny  
2600

top

W veneer top

**progeny** modesty options:  
CM - chemcast modesty (P-95)  
MM - graphite metal modesty  
SM - silver metal modesty  
VM - veneer modesty

edge



\* LB4 leg can be replaced with a PLB (wood leg) at no upcharge

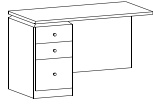

**model number**  
R2648L-VM - \_ - \_

**description**  
single pedestal return  
left box/box/file pedestal  
veneer modesty panel  
  
CHEMCAST MODESTY (LIST) \$498

**d w h**  
24 48 29  
KNEESPACE: 31.75"

**freight**  
class 125  
cwt 160 lb  
cu ft 22

**list \$ zone 1**  
2,430

**list \$ zone 2**  
2,623

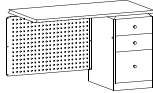

**model number**  
R2648R-MM - \_ - \_

**description**  
single pedestal return  
right box/box/file pedestal  
metal modesty panel  
  
CHEMCAST MODESTY (LIST) \$498

**d w h**  
24 48 29  
KNEESPACE: 31.75"

**freight**  
class 125  
cwt 155 lb  
cu ft 22

**list \$**  
2,430

**list \$**  
2,623

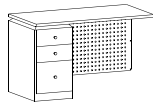

**model number**  
R2648L-MM - \_ - \_

**description**  
single pedestal return  
left box/box/file pedestal  
metal modesty panel  
  
CHEMCAST MODESTY (LIST) \$498

**d w h**  
24 48 29  
KNEESPACE: 31.75"

**freight**  
class 125  
cwt 155 lb  
cu ft 22

**list \$**  
2,430

**list \$**  
2,623



**model number**  
B2660-VM - \_ - \_

**description**  
bridge  
open kneespace  
veneer modesty panel  
  
CHEMCAST MODESTY (LIST) \$647

**d w h**  
24 60 29  
KNEESPACE: 58.5"

**freight**  
class 85  
cwt 110 lb  
cu ft 29

**list \$**  
1,103

**list \$**  
1,190

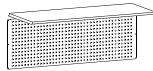

**model number**  
B2660-MM - \_ - \_

**description**  
bridge  
open kneespace  
metal modesty panel  
  
CHEMCAST MODESTY (LIST) \$647

**d w h**  
24 60 29  
KNEESPACE: 58.5"

**freight**  
class 85  
cwt 105 lb  
cu ft 29

**list \$**  
1,103

**list \$**  
1,190



**model number**  
B2648-VM - \_ - \_

**description**  
bridge  
open kneespace  
veneer modesty panel  
  
CHEMCAST MODESTY (LIST) \$498

**d w h**  
24 48 29  
KNEESPACE: 46.5"

**freight**  
class 85  
cwt 105 lb  
cu ft 22

**list \$**  
1,062

**list \$**  
1,146

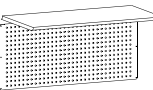

**model number**  
B2648-MM - \_ - \_

**description**  
bridge  
open kneespace  
metal modesty panel  
  
CHEMCAST MODESTY (LIST) \$498

**d w h**  
24 48 29  
KNEESPACE: 46.5"

**freight**  
class 85  
cwt 100 lb  
cu ft 22

**list \$**  
1,062

**list \$**  
1,146

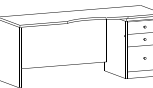

**model number**  
C2672R-AVM - \_ - \_

**description**  
single pedestal credenza  
inside arc on user side  
right box/box/file pedestal  
veneer modesty panel  
  
CHEMCAST MODESTY (LIST) \$636

**d w h**  
24 72 29  
KNEESPACE: 52.5"

**freight**  
class 125  
cwt 170 lb  
cu ft 35

**list \$**  
2,893

**list \$**  
3,126

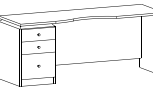

**model number**  
C2672L-AVM - \_ - \_

**description**  
single pedestal credenza  
inside arc on user side  
left box/box/file pedestal  
veneer modesty panel  
  
CHEMCAST MODESTY (LIST) \$636

**d w h**  
24 72 29  
KNEESPACE: 52.5"

**freight**  
class 125  
cwt 170 lb  
cu ft 35

**list \$**  
2,893

**list \$**  
3,126

**veneer**  
tops only

1NC-W natural cherry on cherry  
2HC-W honey cherry on cherry  
9BC-W burgundy cherry on cherry

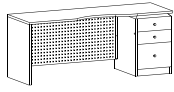
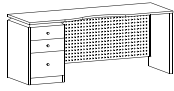
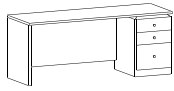
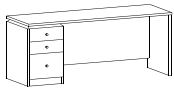
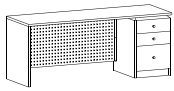
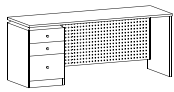
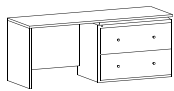
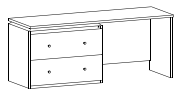
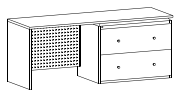

	model number	description			list \$ zone 1	list \$ zone 2
	<b>C2672R-AMM</b> - _ - - _ -	single pedestal credenza inside arc on user side right box/box/file pedestal metal modesty panel  <i>CHEMCAST MODESTY (LIST) \$636</i>	24 72 29 <i>KNEESPACE: 52.5"</i>	class 125 cwt 160 lb cu ft 35	<b>2,893</b>	<b>3,126</b>
	<b>C2672L-AMM</b> - _ - - _ -	single pedestal credenza inside arc on user side left box/box/file pedestal metal modesty panel  <i>CHEMCAST MODESTY (LIST) \$636</i>	24 72 29 <i>KNEESPACE: 52.5"</i>	class 125 cwt 160 lb cu ft 35	<b>2,893</b>	<b>3,126</b>
	<b>C2672R-VM</b> - _ - _ - - _ -	single pedestal credenza right box/box/file pedestal veneer modesty panel  <i>CHEMCAST MODESTY (LIST) \$636</i>	24 72 29 <i>KNEESPACE: 52.5"</i>	class 125 cwt 175 lb cu ft 35	<b>2,613</b>	<b>2,822</b>
	<b>C2672L-VM</b> - _ - _ - - _ -	single pedestal credenza left box/box/file pedestal veneer modesty panel  <i>CHEMCAST MODESTY (LIST) \$636</i>	24 72 29 <i>KNEESPACE: 52.5"</i>	class 125 cwt 175 lb cu ft 35	<b>2,613</b>	<b>2,822</b>
	<b>C2672R-MM</b> - _ - _ - - _ -	single pedestal credenza right box/box/file pedestal metal modesty panel  <i>CHEMCAST MODESTY (LIST) \$636</i>	24 72 29 <i>KNEESPACE: 52.5"</i>	class 125 cwt 165 lb cu ft 35	<b>2,613</b>	<b>2,822</b>
	<b>C2672L-MM</b> - _ - _ - - _ -	single pedestal credenza left box/box/file pedestal metal modesty panel  <i>CHEMCAST MODESTY (LIST) \$636</i>	24 72 29 <i>KNEESPACE: 52.5"</i>	class 125 cwt 165 lb cu ft 35	<b>2,613</b>	<b>2,822</b>
	<b>C2672R-2FVM</b> - _ - - _ -	single pedestal credenza right lateral file pedestal veneer modesty panel  <i>CHEMCAST MODESTY (LIST) \$342</i>	24 72 29 <i>KNEESPACE: 34.25"</i>	class 125 cwt 235 lb cu ft 35	<b>2,734</b>	<b>2,951</b>
	<b>C2672L-2FVM</b> - _ - - _ -	single pedestal credenza left lateral file pedestal veneer modesty panel  <i>CHEMCAST MODESTY (LIST) \$342</i>	24 72 29 <i>KNEESPACE: 34.25"</i>	class 125 cwt 235 lb cu ft 35	<b>2,734</b>	<b>2,951</b>
	<b>C2672R-2FMM</b> - _ - - _ -	single pedestal credenza right lateral file pedestal metal modesty panel  <i>CHEMCAST MODESTY (LIST) \$342</i>	24 72 29 <i>KNEESPACE: 34.25"</i>	class 125 cwt 225 lb cu ft 35	<b>2,734</b>	<b>2,951</b>

top

W veneer top

**progeny** modesty options:  
CM - chemcast modesty (P-95)  
MM - graphite metal modesty  
SM - silver metal modesty  
VM - veneer modesty

edge



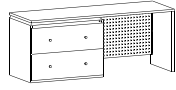

**model number**  
C2672L-2FMM - \_\_  
- \_\_

**description**  
single pedestal credenza  
left lateral file pedestal  
metal modesty panel  
  
CHEMCAST MODESTY (LIST) \$342

**d w h**  
24 72 29  
KNEESPACE: 34.25"

**freight**  
class 125  
cwt 225 lb  
cu ft 35

**list \$ zone 1**  
2,734

**list \$ zone 2**  
2,951

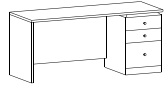

C2666R-VM - \_\_ - \_\_

single pedestal credenza  
right box/file pedestal  
veneer modesty panel  
  
CHEMCAST MODESTY (LIST) \$388

24 66 29  
KNEESPACE: 46.5"

class 125  
cwt 175 lb  
cu ft 35

2,527

2,729

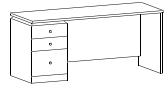

C2666L-VM - \_\_ - \_\_

single pedestal credenza  
left box/file pedestal  
veneer modesty panel  
  
CHEMCAST MODESTY (LIST) \$388

24 66 29  
KNEESPACE: 46.5"

class 125  
cwt 175 lb  
cu ft 35

2,527

2,729

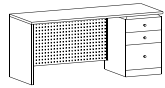

C2666R-MM - \_\_ - \_\_

single pedestal credenza  
right box/file pedestal  
metal modesty panel  
  
CHEMCAST MODESTY (LIST) \$388

24 66 29  
KNEESPACE: 46.5"

class 125  
cwt 165 lb  
cu ft 35

2,527

2,729

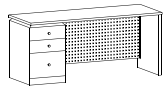

C2666L-MM - \_\_ - \_\_

single pedestal credenza  
left box/file pedestal  
metal modesty panel  
  
CHEMCAST MODESTY (LIST) \$388

24 66 29  
KNEESPACE: 46.5"

class 125  
cwt 165 lb  
cu ft 35

2,527

2,729

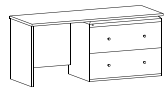

C2666R-2FVM - \_\_  
- \_\_

single pedestal credenza  
right lateral file pedestal  
veneer modesty panel  
  
CHEMCAST MODESTY (LIST) \$342

24 66 29  
KNEESPACE: 28.5"

class 125  
cwt 235 lb  
cu ft 35

2,680

2,893

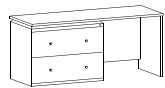

C2666L-2FVM - \_\_  
- \_\_

single pedestal credenza  
left lateral file pedestal  
veneer modesty panel  
  
CHEMCAST MODESTY (LIST) \$342

24 66 29  
KNEESPACE: 28.5"

class 125  
cwt 235 lb  
cu ft 35

2,680

2,893

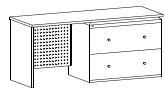

C2666R-2FMM - \_\_  
- \_\_

single pedestal credenza  
right lateral file pedestal  
metal modesty panel  
  
CHEMCAST MODESTY (LIST) \$342

24 66 29  
KNEESPACE: 28.5"

class 125  
cwt 235 lb  
cu ft 35

2,680

2,893

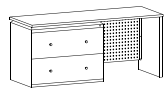

C2666L-2FMM - \_\_  
- \_\_

single pedestal credenza  
left lateral file pedestal  
metal modesty panel  
  
CHEMCAST MODESTY (LIST) \$342

24 66 29  
KNEESPACE: 28.5"

class 125  
cwt 235 lb  
cu ft 35

2,680

2,893

**veneer**  
tops only

1NC-W natural cherry on cherry  
2HC-W honey cherry on cherry  
9BC-W burgundy cherry on cherry

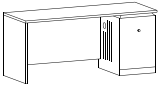
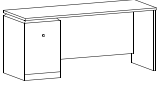
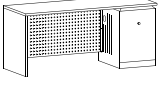
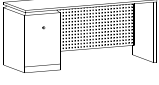
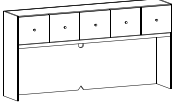
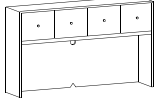
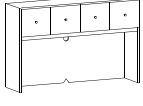
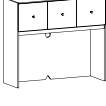
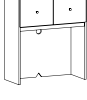
	model number	description			list \$ zone 1	list \$ zone 2
	<b>C2666R-CVM</b> - _ - _	single pedestal credenza right CPU pedestal veneer modesty panel  <i>CHEMCAST MODESTY (LIST) \$388</i>	24 66 29 <i>KNEESPACE: 46.5"</i>	class 125 cwt 165 lb cu ft 35	<b>2,658</b>	<b>2,873</b>
	<b>C2666L-CVM</b> - _ - _ - _	single pedestal credenza left CPU pedestal veneer modesty panel  <i>CHEMCAST MODESTY (LIST) \$388</i>	24 66 29 <i>KNEESPACE: 46.5"</i>	class 125 cwt 165 lb cu ft 35	<b>2,658</b>	<b>2,873</b>
	<b>C2666R-CMM</b> - _ - _	single pedestal credenza right CPU pedestal metal modesty panel  <i>CHEMCAST MODESTY (LIST) \$388</i>	24 66 29 <i>KNEESPACE: 46.5"</i>	class 125 cwt 165 lb cu ft 35	<b>2,658</b>	<b>2,873</b>
	<b>C2666L-CMM</b> - _ - _	single pedestal credenza left CPU pedestal metal modesty panel  <i>CHEMCAST MODESTY (LIST) \$388</i>	24 66 29 <i>KNEESPACE: 46.5"</i>	class 125 cwt 165 lb cu ft 35	<b>2,658</b>	<b>2,873</b>
	<b>OU2684</b> - _ - _	84" wide overhead storage unit five hinged doors wire management standard  <i>CHEMCAST DOORS (LIST) \$540</i>	16.5 83.75 42.5 <i>OPENING: 26.25"</i>	class 125 cwt 205 lb cu ft 40	<b>3,920</b>	<b>4,234</b>
	<b>OU2672</b> - _ - _	72" wide overhead storage unit four hinged doors wire management standard  <i>CHEMCAST DOORS (LIST) \$540</i>	16.5 72 42.5 <i>OPENING: 26.25"</i>	class 125 cwt 205 lb cu ft 40	<b>3,174</b>	<b>3,429</b>
	<b>OU2666</b> - _ - _	66" wide overhead storage unit four hinged doors wire management standard  <i>CHEMCAST DOORS (LIST) \$477</i>	16.5 66 42.5 <i>OPENING: 26.25"</i>	class 125 cwt 175 lb cu ft 38	<b>3,007</b>	<b>3,250</b>
	<b>OU2648</b> - _ - _	48" overhead storage unit with three doors wire management standard  <i>CHEMCAST DOORS (LIST) \$359</i>	16.5 48 42.5 <i>OPENING: 26.25"</i>	class 125 cwt 150 lb cu ft 26	<b>2,416</b>	<b>2,553</b>
	<b>OU2636</b> - _ - _	36" overhead storage unit with two doors wire management standard  <i>CHEMCAST DOORS (LIST) \$271</i>	16.5 36 42.5 <i>OPENING: 26.25"</i>	class 125 cwt 115 lb cu ft 19	<b>1,875</b>	<b>2,046</b>

top

W veneer top

**progeny** modesty options:  
CM - chemcast modesty (P-95)  
MM - graphite metal modesty  
SM - silver metal modesty  
VM - veneer modesty

edge



for **tackboard options**, see pages 486-487  
for standard fabrics available on tackboards, see page 472







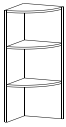
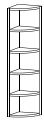
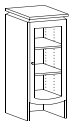
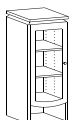

	model number	description	d w h	freight	list \$ zone 1	list \$ zone 2
	<b>OD2684</b> - _	84" wide overhead storage unit open center, one hinged door on each end wire management standard  <i>CHEMCAST DOORS (LIST) \$271</i>	16.5 83.75 42.5 <small>OPENING: 26.25"</small>	class 125 cwt 165 lb cu ft 38	<b>3,734</b>	<b>4,033</b>
<b>[ QS ]</b> 	<b>OD2672</b> - _  Quick Ship available in #2 HC honey cherry finish with USU72 under storage unit included	72" wide overhead storage unit open center, one hinged door on each end wire management standard  <i>CHEMCAST DOORS (LIST) \$271</i>	16.5 83.75 36 <small>OPENING: 26.25"</small>	class 125 cwt 165 lb cu ft 38	<b>2,989</b>	<b>3,228</b>
	<b>OD2666</b> - _	66" wide overhead storage unit open center, one hinged door on each end wire management standard  <i>CHEMCAST DOORS (LIST) \$271</i>	16.5 66 42.5 <small>OPENING: 26.25"</small>	class 125 cwt 165 lb cu ft 38	<b>2,791</b>	<b>3,012</b>
	<b>OUS2660</b> - _	60" wide overhead storage unit four hinged doors adjustable dividers can be placed either horizontally or vertically wire management standard  <i>CHEMCAST DOORS (LIST) \$477</i>	16.5 60 42.5 <small>OPENING: 13.125"</small>	class 125 cwt 235 lb cu ft 28	<b>3,621</b>	<b>3,909</b>
	<b>OUS2648</b> - _	48" wide overhead storage unit three hinged doors adjustable dividers can be placed either horizontally or vertically wire management standard  <i>CHEMCAST DOORS (LIST) \$359</i>	16.5 48 42.5 <small>OPENING: 12.125"</small>	class 125 cwt 195 lb cu ft 23	<b>2,714</b>	<b>2,852</b>
	<b>OUS2636</b> - _	36" wide overhead storage unit two hinged doors adjustable dividers can be placed either horizontally or vertically wire management standard  <i>CHEMCAST DOORS (LIST) \$271</i>	16.5 36 42.5 <small>OPENING: 10.375"</small>	class 125 cwt 130 lb cu ft 18	<b>2,172</b>	<b>2,346</b>
	<b>HS2660</b> - _	60" wide hutch riser adjustable dividers can be placed either horizontally or vertically	16.5 60 28.6 <small>OPENING: 13.126"</small>	class 125 cwt 170 lb cu ft 20	<b>2,170</b>	<b>2,343</b>
	<b>HS2648</b> - _	48" wide hutch riser adjustable dividers can be placed either horizontally or vertically wire management standard	16.5 48 28.6 <small>OPENING: 12.125"</small>	class 125 cwt 130 lb cu ft 16	<b>1,815</b>	<b>1,962</b>
	<b>CUH2642</b> - _	corner unit hutch arc shelf	16.5 42 42.5 <small>OPENING: 28"</small>	class 85 cwt 145 lb cu ft 9	<b>2,383</b>	<b>2,573</b>

veneer  
tops only

1NC-W natural cherry on cherry  
2HC-W honey cherry on cherry  
9BC-W burgundy cherry on cherry

progeny  
2600

	model number	description			list \$ zone 1	list \$ zone 2
	HR2642 - __	hutch radius shelf three fixed shelves indicate if radius is left or right	16.5 16.5 42.5	class 125 cwt 50 lb cu ft 9	930	1,004
	BR72 - __	radius bookcase 1/4 round five fixed shelves	16.5 16.5 72	class 125 cwt 90 lb cu ft 14	1,068	1,155
	VT2645R - __ - __	vertical tower 2 adjustable shelves with curved glass door hinge on right/knob on left  <i>EXTRA SHELF (EACH) \$92</i> <i>CHEMCAST DOORS (LIST) \$434</i> <i>SOLID WOOD SHELVES (EACH) \$28</i>	24 18 45	class 125 cwt 115 lb cu ft 14	2,054	2,222
	VT2645L - __ - __	vertical tower 2 adjustable shelves with curved glass door hinge of left/knob on right  <i>EXTRA SHELF (EACH) \$92</i> <i>CHEMCAST DOORS (LIST) \$434</i> <i>SOLID WOOD SHELVES (EACH) \$28</i>	24 18 45	class 125 cwt 115 lb cu ft 14	2,054	2,222
	USU84 - __	underside paper storage unit mounts under overhead storage units does not prevent the use of task lights or tackboards  <i>FACTORY INSTALLED</i>	15.5 82 4	class cwt lb cu ft	512	554
	USU72 - __	underside paper storage unit mounts under overhead storage units does not prevent the use of task lights or tackboards  <i>FACTORY INSTALLED</i>	15.5 70 4	class 125 cwt 10 lb cu ft	498	536
	USU66 - __	underside paper storage unit mounts under overhead storage units does not prevent the use of task lights or tackboards  <i>FACTORY INSTALLED</i>	15.5 64 4	class 125 cwt 10 lb cu ft	498	536
	USU60 - __	underside paper storage for use with 60 storage overhead units does not prevent the use of task lights or tackboards	15.5 58 4	class cwt lb cu ft	498	536
	USU48 - __	underside paper storage unit mounts under overhead storage units does not prevent the use of task lights or tackboards  <i>FACTORY INSTALLED</i>	16.5 46 4	class cwt lb cu ft	292	315

top



W veneer top

progeny modesty options:  
CM - chemcast modesty (P-95)  
MM - graphite metal modesty  
SM - silver metal modesty  
VM - veneer modesty

edge



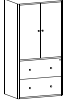
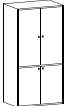
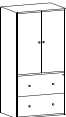
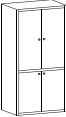
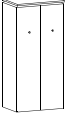

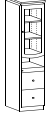



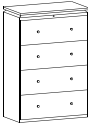

	model number	description	d	w	h	freight	list \$ zone 1	list \$ zone 2
	USU36 - _	underside paper storage unit mounts under overhead storage units does not prevent the use of task lights or tackboards  <i>FACTORY INSTALLED</i>	16.5	34	4	class cwt lb cu ft	292	315
	AV26722F - _	tv cabinet pocket doors pull-out swivel tv tray upper lateral file below	24	36	72	class 125 cwt 340 lb cu ft 43	5,957	6,433
	AV2672HW - _	tv cabinet pocket doors pull-out swivel tv tray upper hinged doors with 1 adjustable shelf below  <i>EXTRA SHELF (EACH) \$92</i> <i>SOLID WOOD SHELVES (EACH) \$28</i>	24	36	72	class 125 cwt 290 lb cu ft 43	5,754	6,217
	HW26722F - _	storage cabinet hinged door upper two adjustable shelves lateral file below  <i>EXTRA SHELF (EACH) \$92</i> <i>SOLID WOOD SHELVES (EACH) \$28</i>	24	36	72	class 125 cwt 340 lb cu ft 43	5,199	5,615
	HW2672HW - _	hinged door cabinet (upper and lower) two adjustable shelves above one adjustable shelf below  <i>ONE PIECE UNITEXTRA SHELF (EACH) \$92</i> <i>SOLID WOOD SHELVES (EACH) \$28</i>	24	36	72	class 125 cwt 270 lb cu ft 43	4,980	5,384
	WD2674 - _ - _	wardrobe cabinet right side coat storage left side 3 adjustable shelves storage shelf above  <i>EXTRA SHELF (EACH) \$92</i> <i>SOLID WOOD SHELVES (EACH) \$28</i>	24	36.5	74	class 125 cwt 275 lb cu ft 42	4,202	4,537
	WD2672R-18 - _ - _	wardrobe cabinet/coat storage hinge on right/knob on left storage shelf above	24	18	74	class 125 cwt 170 lb cu ft 23	3,022	3,277
	WD2674L-18 - _ - _	wardrobe cabinet/coat storage hinge on left/knob on right storage shelf above	24	18	74	class 125 cwt 170 lb cu ft 23	3,022	3,277
[ QS ] 	VT2674R - _ - _  Quick Ship available in #2 HC honey cherry finish	vertical tower 2 adjustable shelves above with curved glass door hinge on right/knob on left file/file storage pedestal <i>EXTRA SHELF (EACH) \$92</i> <i>CHEMCAST DOORS (LIST) \$434</i> <i>SOLID WOOD SHELVES (EACH) \$28</i>	24	18	74	class 125 cwt 235 lb cu ft 29	3,444	3,718

veneer  
tops only

1NC-W natural cherry on cherry  
2HC-W honey cherry on cherry  
9BC-W burgundy cherry on cherry

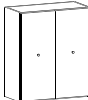
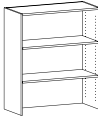
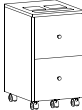
progeny  
2600

[ QS ]	model number	description				list \$ zone 1	list \$ zone 2	
	<b>VT2674L</b> - _ - _ Quick Ship available in #2 HC honey cherry finish	vertical tower 2 adjustable shelves above with curved glass door hinge on left/knob on right file/file storage pedestal <i>EXTRA SHELF (EACH) \$92</i> <i>CHEMCAST DOORS (LIST) \$434</i> <i>SOLID WOOD SHELVES (EACH) \$28</i>	24	18	74	class 125 cwt 235 lb cu ft 29	<b>3,444</b>	<b>3,718</b>
	<b>4FD2637</b> - _ - _	4 drawer lateral file flat ends on top to set next to modular credenzas and other units standard with anti-tip locking mechanism	20.25	36.5	54	class 125 cwt 265 lb cu ft 29	<b>3,665</b>	<b>3,960</b>
	<b>3FD2637</b> - _ - _	3 drawer lateral file flat ends on top to set next to modular credenzas and other units standard with anti-tip locking mechanism	20.25	36.5	42	class 125 cwt 170 lb cu ft 16	<b>3,440</b>	<b>3,715</b>
	<b>2FD2637</b> - _ - _	2 drawer lateral file flat ends on top to set next to modular credenzas and other units standard with anti-tip locking mechanism	20.25	36.5	29	class 125 cwt 170 lb cu ft 16	<b>2,491</b>	<b>2,688</b>
	<b>HW2636</b> - _ - _	hinged door cabinet with wood doors and one adjustable shelf flat ends on top to set next to credenzas and other units <i>EXTRA SHELF (EACH) \$92</i> <i>SOLID WOOD SHELVES (EACH) \$28</i>	20.25	36.5	29	class 125 cwt 150 lb cu ft 16	<b>2,361</b>	<b>2,558</b>
	<b>HW2636-42</b> - _	hutch with two doors and two adjustable shelves <i>EXTRA SHELF (EACH) \$92</i> <i>SOLID WOOD SHELVES (EACH) \$28</i>	17.25	36	42.5	class 125 cwt 140 lb cu ft 20	<b>2,193</b>	<b>2,319</b>
	<b>HO2636-42</b> - _	open hutch with 2 adjustable shelves <i>EXTRA SHELF (EACH) \$92</i> <i>SOLID WOOD SHELVES (EACH) \$28</i>	16.5	36	42.5	class 125 cwt 90 lb cu ft 19	<b>1,495</b>	<b>1,703</b>
	<b>MP262F</b> - _	mobile pedestal file/file drawers with locking casters for use under any 29" surface black tray top	18.9	15.6	27.3	class 125 cwt 75 lb cu ft 6	<b>1,217</b>	<b>1,315</b>
	<b>MP263D</b> - _	mobile pedestal box/box/file drawers with locking casters for use under any 29" surface black tray top	18.9	15.6	27.3	class 125 cwt 75 lb cu ft 6	<b>1,232</b>	<b>1,331</b>

top





W veneer top

**progeny** modesty options:  
CM - chemcast modesty (P-95)  
MM - graphite metal modesty  
SM - silver metal modesty  
VM - veneer modesty

edge

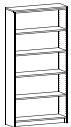
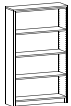
M

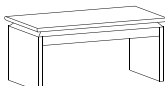
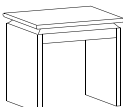

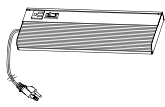
	model number	description	d w h	freight	list \$ zone 1	list \$ zone 2
	BC2672 - _ - _	bookcase three adjustable shelves one fixed shelf in center  <i>EXTRA SHELF (EACH) \$92</i> <i>SOLID WOOD SHELVES (EACH ) \$28</i>	12 36 72	class 125 cwt 120 lb cu ft 24	1,681	1,813
	BC2660 - _ - _	bookcase two adjustable shelves one fixed shelf in center  <i>EXTRA SHELF (EACH) \$92</i> <i>SOLID WOOD SHELVES (EACH ) \$28</i>	12 36 60	class 125 cwt 100 lb cu ft 20	1,576	1,704
	BC2636 - _ - _	bookcase two adjustable shelves  <i>EXTRA SHELF (EACH) \$92</i> <i>SOLID WOOD SHELVES (EACH ) \$28</i>	12 36 36	class 125 cwt 65 lb cu ft 12	1,122	1,216
	T2638 - _ - _	coffee table	20.25 38 17	class 125 cwt 65 lb cu ft 3	761	821
	ET2624 - _ - _	lamp table	19.5 24 22	class 125 cwt 60 lb cu ft 2	669	724
	CTO2642 - _ - _	crescent conference table: top only use with desk end, desk approach, against wall or stand alone 36" on flat side  <i>TOP ONLY BLACK CX BASE W/CASTERS NOT INCLUDED</i>	42 Dia	class 125 cwt 100 lb cu ft 7	1,528	1,661
	CX26-C	black CX bases with casters  <i>FOR USE WITH CTO2642 (ABOVE)</i>		class cwt lb cu ft	578	625
	TL24	task light for use with overhead storage units  <i>FIELD INSTALLED ONLY</i>	7 24 2	class 100 cwt 11 lb cu ft 1	335	364

veneer  
tops only

1NC-W natural cherry on cherry  
2HC-W honey cherry on cherry  
9BC-W burgundy cherry on cherry

progeny  
2600



# inwood

OFFICE  
ENVIRONMENTS

## price list

effective 01 january 2012

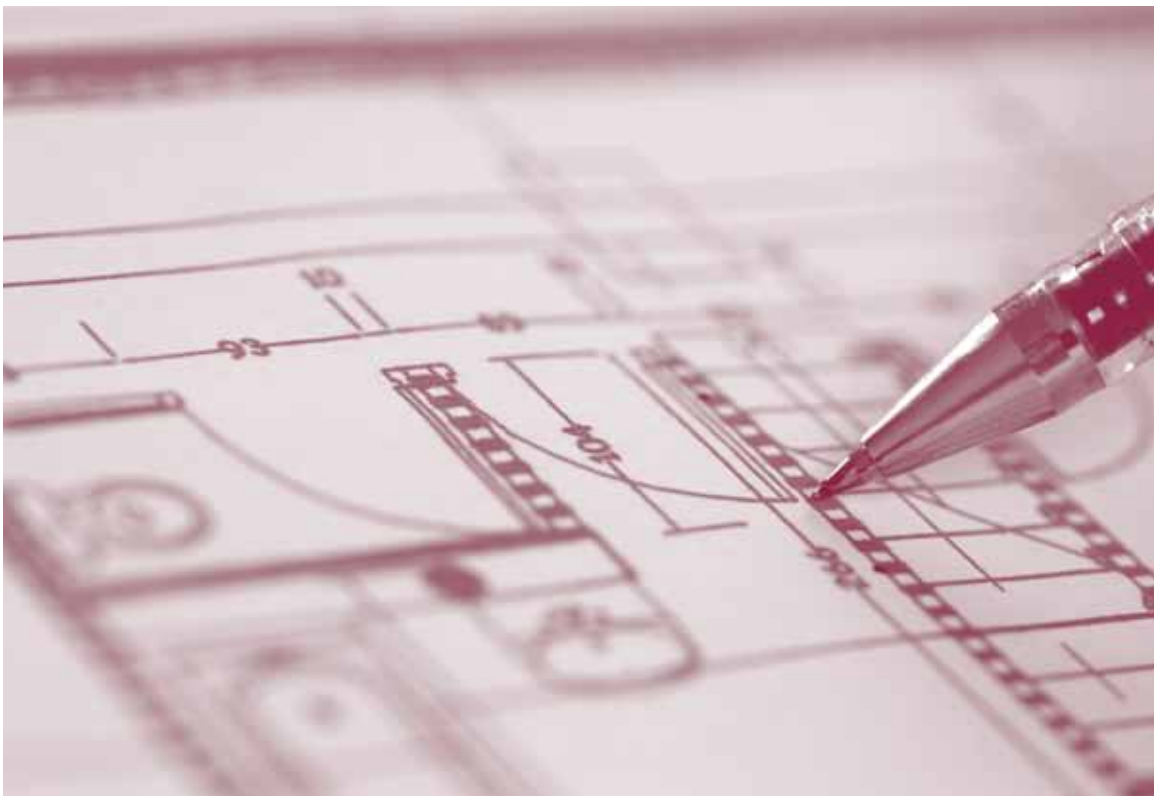

account # \_\_\_\_\_  
discount \_\_\_\_\_  
zone \_\_\_\_\_  
c.s.r. \_\_\_\_\_  
sales rep. \_\_\_\_\_

trek  
2500

[click here for warranty  
and terms information](#)

zones one and two



# inwood

OFFICE  
ENVIRONMENTS

---



trek  
2500

### trek 2500 series specifications

#### materials:

All wood is thoroughly air and kiln dried to a moisture content not to exceed 8% at the time of assembly.

#### veneers:

All exposed surfaces are plain sliced Birch. Veneers are carefully slip-matched and balanced. All drawer fronts, doors, end panels, and modesty panels are vertical grain.

#### top work surfaces:

- **wood veneer tops** are 1 1/4" thick, 5-ply construction, consisting of 1/40" thick veneer work surfaces and Gator-Ply backing. The top core material is a 45 lb density flake board. Top rims are 3/4" hardwood with the choice of top edge shape on all four sides.
- **high pressure laminate tops** are 1 1/4", 3-ply construction; consisting of a high-pressure laminate work surface and a 45 lb density flake board core. The underside of the top has a smooth surface Gator-Ply backing sheet and high pressure laminate edges. Top rims are 3/4" hardwood with the choice of top edge shape on all four sides. Laminate self edge tops have all four edges banded in laminate. Laminate PVC edge tops have four sides banded in PVC.

#### modesty panels:

- **wood veneer modesty panels**  
1 1/4" recessed 3/4" thick, 3-ply construction with a vertical veneer on exposed surfaces and a 45 lb density particle board core.
- **durasyn modesty panels**  
1 1/4" recessed 3/4" thick, MDF board with durasyn tinted paint finish.

#### construction:

Uses a mortise & tenon and glue to join panels and modesty panels. All joints are reinforced with glue blocks. All bookcase shelves are standard 3/4" thick.

#### drawers:

Drawer fronts are 3/4" thick, 3-ply construction with vertical slip matched veneer. Drawer edges are veneered on top and sides with matching wood veneers. All drawer sides and backs are plywood, dovetailed front and back with 3-ply drawer bottoms. Drawer bottoms are framed on four sides and stapled from the bottom side. Drawer interiors are finished with a clear coat sealer to prevent swelling or shrinkage. Box drawers have a high grade Sterling metal ball-bearing drawer suspension. File drawers have a high grade Sterling metal ball bearing full progressive suspension and are equipped with metal rods for hanging file folders. All drawers have smooth quiet operation.

#### inside drawer dimensions:

box drawers: 4" H x 12 1/8" W x 15 9/16" L  
4" H x 12 1/8" W x 22 1/8" L  
file drawers: 9 1/2" H x 12 1/8" W x 15 9/16" L  
9 1/2" H x 12 1/8" W x 25 3/8" L  
lateral files: 9 1/2" H x 32 5/8" W x 16" L

#### locking:

Each pedestal has its own lock and is keyed alike for each unit. Each unit is equipped with two keys. Units may be keyed alike in groups (per office, if requested) for an additional charge of \$36 list per unit.

#### finish:

All Inwood finishes are catalyzed varnish finish. Our multi-step satin finishes leave an open grain natural look to the furniture. Available in following cherry finishes: (6LC) light cherry on birch, (7MC) medium cherry on birch, (8DC) dark cherry on birch, (NB) natural birch on birch, (MB) mocha birch on birch, (CB) cherry birch on birch, (2ML) natural maple on birch, (3ML) light maple on birch, (4ML) medium maple on birch, and (5ML) cherry on birch. Twelve Durasyn textured paint finishes standard. Durasyn is a tinted painted finish with post-catalyzed varnish and acid cured topcoats formulated for superior performance on MDF. Durasyn offers superior scratch, mar, chemical and moisture resistance properties. Durasyn has been enhanced with UV absorbers to further increase UV protection.

#### pulls/grommets:

Pulls are available in three styles for trek series furniture.

BB- black bar



CB- chrome bar



CC- chrome cable

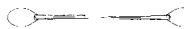

**Grommets are based upon color of pull. Standard black with black pulls and standard silver with silver pulls.**

#### chassis options

Trek chassis products are available for specification in the following four distinct combinations



**VV:**  
Veneer Chassis and Veneer drawer fronts.



**VD:**  
Veneer Chassis and Durasyn drawer fronts.



**DV:**  
Durasyn Chassis and Veneer drawer fronts.



**DD:**  
Durasyn Chassis and Durasyn drawer fronts.

#### modesty and overhead door options:



chemcast  
doors only



veneer



**30" deep pedestals**

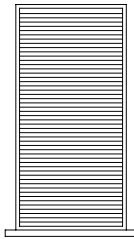

letter  
side to side

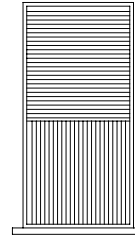
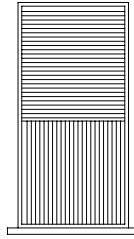

**24" deep pedestals**

letter  
front to back

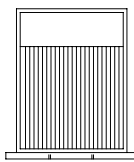
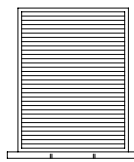

**lateral files**

letter  
front to back

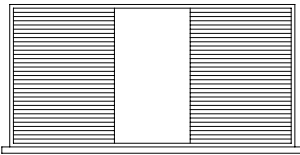

legal  
front to back

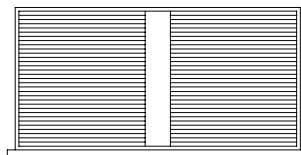

letter  
side to side

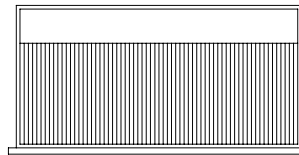

legal  
side to side

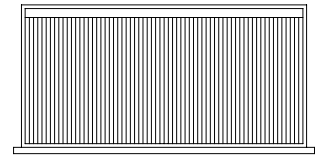

**25-2448-LI-MB-MB**

- ① **Top configuration**
- Top Size ..... 24x48
- Material ..... "L" Laminate top wood rim
- Edge ..... "I" shape
- Finish of top ..... "MB" mocha on birch
- Edge finish ..... "MB" mocha on birch

**25-3672-LI-MB-MB**

- ① **Top configuration**
- Top Size ..... 36x72
- Material ..... "L" Laminate top wood rim
- Edge ..... "I" shape
- Finish of top ..... "MB" mocha on birch
- Edge finish ..... "MB" mocha on birch

**25-30ES-DD-EW**

- ③ **End Support configuration**
- Size of support ..... "30"
- Type of support ..... "ES" end support
- Material/Finish ..... "DD" Durasyn
- Finish ..... "EW" eggshell white

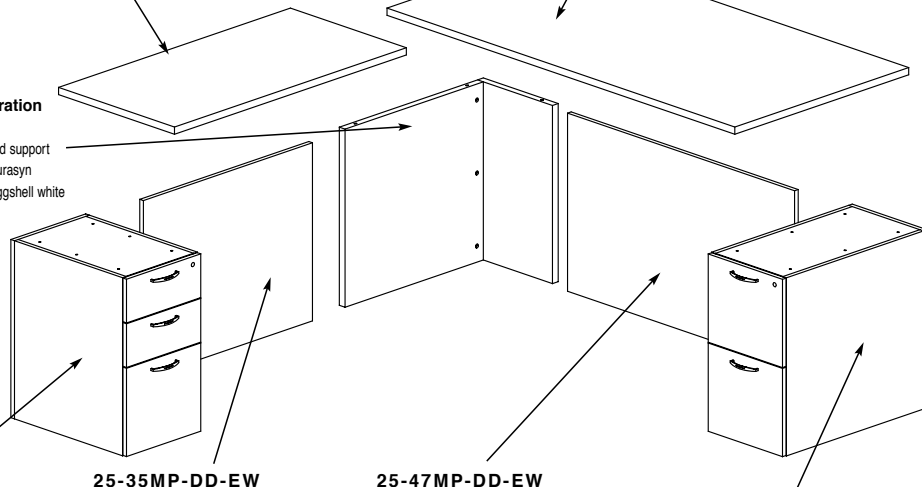

**25-243D-VD-4ML-EW-CC**

- ② **Pedestal configuration**
- Pedestal Depth ..... 24" 3 drawers (b/b/f)
- Chassis Finish ..... "V" Veneer 4ML (med maple on birch)
- Drawer Front Finish ..... "D" Durasyn "EW" (eggshell white)
- Drawer Pull ..... "CC" chrome cable

**25-35MP-DD-EW**

- ④ **Modesty Panel configuration**
- Type of support ..... "MP" modesty panel
- Size of modesty ..... "35"
- Material/Finish ..... "DD" Durasyn
- Finish ..... "EW" eggshell white

**25-47MP-DD-EW**

- ④ **Modesty Panel configuration**
- Type of support ..... "MP" modesty panel
- Size of modesty ..... "47"
- Material/Finish ..... "DD" Durasyn
- Finish ..... "EW" eggshell white

**25-302F-VD-4ML-EW-CC**

- ② **Pedestal configuration**
- Pedestal Depth ..... 30" 2 file drawers
- Chassis Finish ..... "V" Veneer 4ML (med maple on birch)
- Drawer Front Finish ..... "D" Durasyn "EW" (eggshell white)
- Drawer Pull ..... "CC" chrome cable

	top size	model number	d	w	h	freight				
	rectangular top 24" x _	25-2436T - _ - - _ - _	24	36	1.25	cwt 40 lb	cu ft 2	class 70		
		25-2442T - _ - - _ - _	24	42	1.25	cwt 45 lb	cu ft 2	class 70		
		25-2448T - _ - - _ - _	24	48	1.25	cwt 50 lb	cu ft 2	class 70		
		25-2454T - _ - - _ - _	24	54	1.25	cwt 60 lb	cu ft 2	class 70		
		25-2460T - _ - - _ - _	24	60	1.25	cwt 65 lb	cu ft 3	class 70		
		25-2466T - _ - - _ - _	24	66	1.25	cwt 70 lb	cu ft 3	class 70		
		25-2472T - _ - - _ - _	20	72	1.25	cwt 75 lb	cu ft 3	class 70		
		25-2478T - _ - - _ - _	24	78	1.25	cwt 80 lb	cu ft 3	class 70		
		25-2484T - _ - - _ - _	24	84	1.25	cwt 85 lb	cu ft 3	class 70		
		25-2490T - _ - - _ - _	24	90	1.25	cwt 90 lb	cu ft 4	class 70		
		25-2496T - _ - - _ - _	24	96	1.25	cwt 95 lb	cu ft 4	class 70		
		25-24108T - _ - - _ - _	24	108	1.25	cwt 105 lb	cu ft 4	class 70		
		25-24120T - _ - - _ - _	24	120	1.25	cwt 115 lb	cu ft 4	class 70		
	rectangular top 30" x _	25-3048T - _ - - _ - _	30	48	1.25	cwt 80 lb	cu ft 3	class 70		
		25-3054T - _ - - _ - _	30	54	1.25	cwt 85 lb	cu ft 3	class 70		
		25-3060T - _ - - _ - _	30	60	1.25	cwt 90 lb	cu ft 3	class 70		
		25-3066T - _ - - _ - _	30	66	1.25	cwt 95 lb	cu ft 3	class 70		
		25-3072T - _ - - _ - _	30	72	1.25	cwt 100 lb	cu ft 3	class 70		
		25-3078T - _ - - _ - _	30	78	1.25	cwt 105 lb	cu ft 4	class 70		
		25-3084T - _ - - _ - _	30	84	1.25	cwt 110 lb	cu ft 4	class 70		
		25-3090T - _ - - _ - _	30	90	1.25	cwt 115 lb	cu ft 4	class 70		
		25-3096T - _ - - _ - _	90	96	1.25	cwt 120 lb	cu ft 4	class 70		
		25-30108T - _ - - _ - _	30	108	1.25	cwt 130 lb	cu ft 5	class 70		
		25-30120T - _ - - _ - _	30	120	1.5	cwt 140 lb	cu ft 5	class 70		
			rectangular top 36" x _	25-3648T - _ - - _ - _	36	48	1.25	cwt 85 lb	cu ft 3	class 70
				25-3654T - _ - - _ - _	36	54	1.25	cwt 90 lb	cu ft 3	class 70
25-3660T - _ - - _ - _	36			60	1.25	cwt 95 lb	cu ft 4	class 70		
25-3666T - _ - - _ - _	36			66	1.25	cwt 100 lb	cu ft 4	class 70		
25-3672T - _ - - _ - _	36			72	1.25	cwt 105 lb	cu ft 4	class 70		
25-3678T - _ - - _ - _	36			78	1.25	cwt 110 lb	cu ft 4	class 70		
25-3684T - _ - - _ - _	36			84	1.25	cwt 115 lb	cu ft 4	class 70		
25-3690T - _ - - _ - _	36			90	1.25	cwt 120 lb	cu ft 4	class 70		
25-3696T - _ - - _ - _	36			96	1.25	cwt 125 lb	cu ft 5	class 70		

trek  
2500

top

**L** laminate top  
**V** veneer top

**wood**  
top &  
edge  
finishes

**2ML-W** natural maple on birch  
**3ML-W** light maple on birch  
**4ML-W** medium maple on birch  
**5ML-W** cherry on birch  
**6LC-W** light cherry on birch  
**7MC-W** medium cherry on birch  
**8DC-W** dark cherry on birch  
**CB-W** cherry on birch  
**MB-W** mocha on birch  
**NB-W** natural on birch

edge

**BL** black  
**FG** fog  
**FS** folkstone  
**HZ** haze  
**LB** light beige  
**PD** pepperdust  
**SL** slate

edge



**top sizes** to cut down any standard size top to specified dimensions  
add \$126 to the next highest price  
**grommets** reference page 168 for pricing and location of optional grommets



veneer top SELF EDGE VS <small>TOP AND EDGE COLOR HAVE SAME FINISH</small>		veneer top WOOD EDGE VH / VI <small>TOP AND EDGE COLOR HAVE SAME FINISH</small>		laminate top SELF EDGE LS <small>SPECIFY BOTH TOP AND EDGE COLOR</small>		laminate top PVC EDGE LP <small>SPECIFY BOTH TOP AND EDGE COLOR</small>		laminate top WOOD EDGE LH / LI <small>SPECIFY BOTH TOP AND EDGE COLOR</small>	
list \$ zone 1	list \$ zone 2	list \$ zone 1	list \$ zone 2	list \$ zone 1	list \$ zone 2	list \$ zone 1	list \$ zone 2	list \$ zone 1	list \$ zone 2
644	696	644	696	142	155	207	220	223	245
705	761	-	-	161	174	257	277	282	303
710	768	710	768	179	193	273	297	297	298
768	827	-	-	194	209	313	339	328	354
808	873	-	-	210	230	333	360	347	376
852	921	852	921	267	291	380	412	408	441
1,001	1,079	1,001	1,079	281	301	410	443	446	479
1,424	1,538	-	-	303	328	442	476	492	530
1,424	1,538	-	-	322	347	581	629	632	684
1,531	1,653	-	-	339	368	594	644	665	719
1,531	1,653	-	-	359	387	609	660	689	743
-	-	-	-	493	522	642	693	993	1,078
-	-	-	-	549	593	698	755	1,280	1,380
950	1,025	-	-	257	274	347	376	405	439
955	1,030	-	-	333	360	437	470	499	538
1,017	1,099	1,017	1,099	354	381	461	500	519	562
1,075	1,160	1,075	1,160	374	405	467	506	542	588
1,177	1,232	-	-	397	428	510	551	614	665
1,474	1,591	-	-	452	486	560	603	1,010	1,089
1,588	1,715	-	-	717	774	1,118	1,212	1,251	1,353
1,700	1,836	-	-	735	795	1,157	1,248	1,276	1,378
1,814	1,960	-	-	759	820	1,181	1,275	1,302	1,408
-	-	-	-	802	865	1,328	1,436	1,794	1,930
-	-	-	-	860	929	1,387	1,497	1,905	2,058
1,270	1,371	-	-	301	326	394	425	462	502
1,284	1,388	-	-	354	381	431	467	467	505
1,301	1,406	-	-	396	426	470	508	516	558
1,370	1,479	1,370	1,479	416	450	542	588	553	596
1,652	1,784	1,652	1,784	613	664	752	811	802	868
-	-	-	-	742	800	776	839	904	976
-	-	-	-	758	818	1,131	1,222	1,231	1,328
-	-	-	-	772	834	1,144	1,235	1,243	1,345
-	-	-	-	787	850	1,168	1,263	1,270	1,371

laminates  
wood  
pattern  
  
top &  
edge  
finishes

2ML-P natural maple on birch  
3ML-P light maple on birch  
4ML-P medium maple on birch  
5ML-P cherry on birch  
6LC-P light cherry on birch  
7MC-P medium cherry on birch  
8DC-P dark cherry on birch  
CB-P cherry on birch  
EW-P eggshell white  
MB-P mocha on birch  
NB-P natural on birch







laminates  
solid &  
mixed  
colors  
  
top &  
edge  
finishes

BA CLCM  
EWGS RA  
BB CNCO  
GVNV SUTY

BLCF  
CU OS  
WH

laminates  
top &  
edge  
finishes

Designer palette (5% upcharge plus \$80 net freight charge)  
SPL special laminate, provide manufacturer and item # \_\_\_\_\_

	top shape	model number	d	w	h	freight		
	bridge/return top 24" x __	25-4224T - __ - __ - __	24	42	1.25	cwt 45 lb	cu ft 2	class 70
		25-4824T - __ - __ - __	24	48	1.25	cwt 50 lb	cu ft 2	class 70
		25-5424T - __ - __ - __	24	54	1.25	cwt 60 lb	cu ft 2	class 70
		25-6024T - __ - __ - __	24	60	1.25	cwt 65 lb	cu ft 3	class 70
	D shaped bullet top 24" x __	25-2460DT - __ - __ - __	24	60	1.25	cwt 65 lb	cu ft 3	class 70
		25-2466DT - __ - __ - __	24	66	1.25	cwt 70 lb	cu ft 3	class 70
		25-2472DT - __ - __ - __	24	72	1.25	cwt 75 lb	cu ft 3	class 70
	D shaped bullet top 30" x __	25-3060DT - __ - __ - __	30	60	1.25	cwt 95 lb	cu ft 3	class 70
		25-3066DT - __ - __ - __	30	66	1.25	cwt 95 lb	cu ft 3	class 70
		25-3072DT - __ - __ - __	30	72	1.25	cwt 100 lb	cu ft 3	class 70
		25-3078DT - __ - __ - __	30	78	1.25	cwt 105 lb	cu ft 3	class 70
		25-3084DT - __ - __ - __	30	84	1.25	cwt 110 lb	cu ft 4	class 70
		25-3090DT - __ - __ - __	30	90	1.25	cwt 115 lb	cu ft 4	class 70
	D shaped bullet top 36" x __	25-3666DT - __ - __ - __	36	66	1.25	cwt 100 lb	cu ft 4	class 70
		25-3672DT - __ - __ - __	36	72	1.25	cwt 105 lb	cu ft 4	class 70
		25-3678DT - __ - __ - __	36	78	1.25	cwt 110 lb	cu ft 4	class 70
		25-3684DT - __ - __ - __	36	84	1.25	cwt 115 lb	cu ft 4	class 70
		25-3690DT - __ - __ - __	36	90	1.25	cwt 120 lb	cu ft 4	class 70
		25-3696DT - __ - __ - __	36	96	1.25	cwt 125 lb	cu ft 5	class 70
	bow shaped top 36" at center x __	25-3672BT - __ - __ - __	36	72	1.25	cwt 105 lb	cu ft 4	class 70
		25-3678BT - __ - __ - __	36	78	1.25	cwt 125 lb	cu ft 4	class 70
	bow shaped top 42" at center x __	25-4272BT - __ - __ - __	42	72	1.25	cwt 115 lb	cu ft 4	class 70
		25-4278BT - __ - __ - __	42	78	1.25	cwt 135 lb	cu ft 4	class 70

top

**L** laminate top  
**V** veneer top

**wood**  
top &  
edge  
finishes

**2ML-W** natural maple on birch  
**3ML-W** light maple on birch  
**4ML-W** medium maple on birch  
**5ML-W** cherry on birch  
**6LC-W** light cherry on birch  
**7MC-W** medium cherry on birch  
**8DC-W** dark cherry on birch  
**CB-W** cherry on birch  
**MB-W** mocha on birch  
**NB-W** natural on birch

edge

**BL** black  
**FG** fog  
**FS** folkstone  
**HZ** haze  
**LB** light beige  
**PD** pepperdust  
**SL** slate

edge



**top sizes** to cut down any standard size top to specified dimensions  
add \$126 to the next highest price  
**grommets** reference page 168 for pricing and location of optional grommets



veneer top SELF EDGE VS <small>TOP AND EDGE COLOR HAVE SAME FINISH</small>		veneer top WOOD EDGE VH / VI <small>TOP AND EDGE COLOR HAVE SAME FINISH</small>		laminite top SELF EDGE LS <small>SPECIFY BOTH TOP AND EDGE COLOR</small>		laminite top PVC EDGE LP <small>SPECIFY BOTH TOP AND EDGE COLOR</small>		laminite top WOOD EDGE LH / LI <small>SPECIFY BOTH TOP AND EDGE COLOR</small>	
list \$ zone 1	list \$ zone 2	list \$ zone 1	list \$ zone 2	list \$ zone 1	list \$ zone 2	list \$ zone 1	list \$ zone 2	list \$ zone 1	list \$ zone 2
705	761	-	-	161	174	257	277	282	303
710	768	710	768	179	193	273	297	298	323
768	827	-	-	194	209	313	339	328	354
808	873	-	-	210	230	333	360	347	376
1,938	2,095	-	-	462	501	588	634	774	837
2,034	2,197	-	-	501	539	625	671	811	874
2,346	2,535	-	-	538	580	672	727	-	-
1,455	1,570	-	-	567	612	693	747	-	-
1,736	1,873	-	-	636	689	721	779	-	-
2,016	2,176	-	-	656	709	753	812	-	-
-	-	-	-	673	730	781	845	-	-
-	-	-	-	840	907	985	1,064	-	-
-	-	-	-	860	927	1,016	1,099	-	-
-	-	-	-	879	951	1,044	1,129	-	-
2,598	2,806	2,598	2,806	591	638	709	766	1,226	1,323
2,734	2,951	2,734	2,951	718	776	837	903	1,355	1,462
-	-	-	-	1,042	1,123	1,165	1,230	-	-
-	-	-	-	1,170	1,265	1,268	1,370	-	-
-	-	-	-	1,301	1,403	1,412	1,526	-	-
-	-	-	-	1,431	1,538	1,538	1,662	-	-
2,821	3,049	-	-	670	726	811	874	861	930
-	-	-	-	807	870	844	910	-	-
2,821	3,049	2,821	3,049	726	784	865	934	914	997
-	-	-	-	863	932	899	969	953	1,029

laminite  
wood  
pattern  
  
top &  
edge  
finishes

2ML-P natural maple on birch  
3ML-P light maple on birch  
4ML-P medium maple on birch  
5ML-P cherry on birch  
6LC-P light cherry on birch  
7MC-P medium cherry on birch  
8DC-P dark cherry on birch  
CB-P cherry on birch  
EW-P eggshell white  
MB-P mocha on birch  
NB-P natural on birch

laminite  
solid &  
mixed  
colors  
  
top &  
edge  
finishes

BA  
CLCM  
EWGS  
RA

BB  
CNCV  
GVNV  
SUTY

BLCF  
CU  
OS  
WH

laminite  
top &  
edge  
finishes

Designer palette (5% upcharge plus  
\$80 net freight charge)  
SPL special laminate,  
provide manufacturer  
and item # \_\_\_\_\_



	top shape	model number	d	w	h	freight		
	P shaped top 30" x 36"	<b>25-3066PTR</b> - _ - _ - _ -	30	66	1.25	cwt 100 lb	cu ft 4	class 70
		<b>25-3072PTR</b> - _ - _ - _ -	30	72	1.25	cwt 105 lb	cu ft 4	class 70
	P shaped top 30" x 36"	<b>25-3066PTL</b> - _ - _ - _ -	30	66	1.25	cwt 100 lb	cu ft 4	class 70
		<b>25-3072PTL</b> - _ - _ - _ -	30	72	1.25	cwt 105 lb	cu ft 4	class 70
	P shaped top 36" x 36"	<b>25-3672PTR</b> - _ - _ - _ -	36	72	1.25	cwt 115 lb	cu ft 4	class 70
		<b>25-3678PTR</b> - _ - _ - _ -	36	78	1.25	cwt 125 lb	cu ft 4	class 70
		<b>25-3684PTR</b> - _ - _ - _ -	36	84	1.25	cwt 135 lb	cu ft 5	class 70
		<b>25-3690PTR</b> - _ - _ - _ -	36	90	1.25	cwt 145 lb	cu ft 5	class 70
		<b>25-3696PTR</b> - _ - _ - _ -	36	96	1.25	cwt 155 lb	cu ft 5	class 70
	P shaped top 36" x 36"	<b>25-3672PTL</b> - _ - _ - _ -	36	72	1.25	cwt 115 lb	cu ft 4	class 70
		<b>25-3678PTL</b> - _ - _ - _ -	36	78	1.25	cwt 125 lb	cu ft 4	class 70
		<b>25-3684PTL</b> - _ - _ - _ -	36	84	1.25	cwt 135 lb	cu ft 5	class 70
		<b>25-3690PTL</b> - _ - _ - _ -	36	90	1.25	cwt 145 lb	cu ft 5	class 70
		<b>25-3696PTL</b> - _ - _ - _ -	36	96	1.25	cwt 155 lb	cu ft 5	class 70
	angled return top 24"-36" x 36"	<b>25-2466CUR</b> - _ - _ - _ -	24/36	66	1.25	cwt 95 lb	cu ft 4	class 70
		<b>25-2466CUL</b> - _ - _ - _ -	24/36	66	1.25	cwt 95 lb	cu ft 4	class 70
	arc return top 24"-36" x 36"	<b>25-2466ACUR</b> - _ - _ - _ -	24/36	66	1.25	cwt 95 lb	cu ft 4	class 70
		<b>25-2466ACUL</b> - _ - _ - _ -	24/36	66	1.25	cwt 95 lb	cu ft 4	class 70

top

**L** laminate top  
**V** veneer top

**wood**  
top &  
edge  
finishes

**2ML-W** natural maple on birch  
**3ML-W** light maple on birch  
**4ML-W** medium maple on birch  
**5ML-W** cherry on birch  
**6LC-W** light cherry on birch  
**7MC-W** medium cherry on birch  
**8DC-W** dark cherry on birch  
**CB-W** cherry on birch  
**MB-W** mocha on birch  
**NB-W** natural on birch

edge

**BL** black  
**FG** fog  
**FS** folkstone  
**HZ** haze  
**LB** light beige  
**PD** pepperdust  
**SL** slate

edge



**top sizes** to cut down any standard size top to specified dimensions  
add \$126 to the next highest price  
**grommets** reference page 168 for pricing and location of optional grommets



veneer top SELF EDGE VS <small>TOP AND EDGE COLOR HAVE SAME FINISH</small>		veneer top WOOD EDGE VH / VI <small>TOP AND EDGE COLOR HAVE SAME FINISH</small>		laminite top SELF EDGE LS <small>SPECIFY BOTH TOP AND EDGE COLOR</small>		laminite top PVC EDGE LP <small>SPECIFY BOTH TOP AND EDGE COLOR</small>		laminite top WOOD EDGE LH / LI <small>SPECIFY BOTH TOP AND EDGE COLOR</small>	
list \$ zone 1	list \$ zone 2	list \$ zone 1	list \$ zone 2	list \$ zone 1	list \$ zone 2	list \$ zone 1	list \$ zone 2	list \$ zone 1	list \$ zone 2
-	-	-	-	727	784	845	911	-	-
-	-	-	-	794	856	909	983	-	-
-	-	-	-	727	784	845	911	-	-
-	-	-	-	794	856	909	983	-	-
3,247	3,507	3,247	3,507	1,486	1,607	1,607	1,735	2,537	2,739
3,247	3,507	3,247	3,507	1,508	1,628	1,624	1,755	2,568	2,774
3,247	3,507	3,247	3,507	1,629	1,761	1,748	1,889	2,743	2,963
-	-	-	-	1,648	1,780	1,768	1,906	-	-
-	-	-	-	1,667	1,800	1,783	1,928	-	-
3,247	3,507	3,247	3,507	1,486	1,607	1,607	1,735	2,537	2,739
3,247	3,507	3,247	3,507	1,508	1,628	1,624	1,755	2,568	2,774
3,247	3,507	3,247	3,507	1,629	1,761	1,748	1,889	2,743	2,963
-	-	-	-	1,648	1,780	1,768	1,906	-	-
-	-	-	-	1,667	1,800	1,783	1,928	-	-
1,132	1,223	-	-	636	690	755	815	-	-
1,132	1,223	-	-	636	690	755	815	-	-
1,412	1,524	-	-	636	690	759	815	-	-
1,412	1,524	-	-	636	690	755	815	-	-

**laminite**  
wood  
pattern  
  
top &  
edge  
finishes

**2ML-P** natural maple on birch  
**3ML-P** light maple on birch  
**4ML-P** medium maple on birch  
**5ML-P** cherry on birch  
**6LC-P** light cherry on birch  
**7MC-P** medium cherry on birch  
**8DC-P** dark cherry on birch  
**CB-P** cherry on birch  
**EW-P** eggshell white  
**MB-P** mocha on birch  
**NB-P** natural on birch

**laminite**  
solid &  
mixed  
colors  
  
top &  
edge  
finishes







**BA**  
**CLCM**  
**EWGS**  
**RA**

**BB**  
**CNCV**  
**GVNV**  
**SUTY**

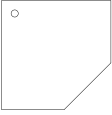
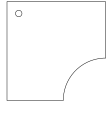

**BLCF**  
**CU**  
**OS**  
**WH**

**laminite**  
top &  
edge  
finishes

**Designer palette** (5% upcharge plus  
\$80 net freight charge)  
**SPL** special laminate,  
provide manufacturer  
and item # \_\_\_\_\_

	top shape	model number	d	w	h	freight		
	angled corner top 24" x 42"	<b>25-2442CU</b> - _ - _ - _	24	42	1.25	cwt 50 lb	cu ft 3	class 70
	30" x 42"	<b>25-3042CU</b> - _ - _ - _	30	42	1.25	cwt 55 lb	cu ft 3	class 70
	<i>2) MPK INCLUDED</i>							
	arc corner top 24" x 42"	<b>25-2442ACU</b> - _ - _ - _	24	42	1.25	cwt 50 lb	cu ft 3	class 70
	30" x 42"	<b>25-3042ACU</b> - _ - _ - _	30	42	1.25	cwt 55 lb	cu ft 3	class 70
	<i>2) MPK INCLUDED ONE STANDARD GROMMET</i>							
	counter top 12" x 66"	<b>TT2566</b> - _ - _ - _	12	66	1.25	cwt 35 lb	cu ft 2	class 85
	counter top 12" x 72"	<b>TT2572</b> - _ - _ - _	12	72	1.25	cwt 40 lb	cu ft 2	class 85
	lateral file top 20" x 36"	<b>25-2036T</b> - _	20	36	1.25	cwt 40 lb	cu ft 2	class 70
	<i>THESE TOPS CAN BE USED AS A COMMON TOP FOR MULTIPLE LATERAL FILES.</i>							
	lateral file top 20" x 72"	<b>25-2072T</b> - _	20	72	1.25	cwt 75 lb	cu ft 3	class 70
	<i>THESE TOPS CAN BE USED AS A COMMON TOP FOR MULTIPLE LATERAL FILES.</i>							
	lateral file top 20" x 108"	<b>25-20108T</b> - _	20	108	1.25	cwt 105 lb	cu ft 4	class 70
	<i>THESE TOPS CAN BE USED AS A COMMON TOP FOR MULTIPLE LATERAL FILES.</i>							
	bookcase top 12" x 36"	<b>25-1236T</b> - _	12	36	1.25	cwt 20 lb	cu ft 3	class 70
	bookcase top 12" x 72"	<b>25-1272T</b> - _	12	72	1.25	cwt 45 lb	cu ft 3	class 70
	<i>NO TOPS ON UNITS USE PAGE 140 TOPS TO COMPLETE UNIT</i>							

trek  
2500

top	L V laminate top veneer top	wood top & edge finishes	2ML-W natural maple on birch 3ML-W light maple on birch 4ML-W medium maple on birch 5ML-W cherry on birch 6LC-W light cherry on birch 7MC-W medium cherry on birch 8DC-W dark cherry on birch CB-W cherry on birch MB-W mocha on birch NB-W natural on birch	edge	BL black FG fog FS folkstone HZ haze LB light beige PD pepperdust SL slate
edge		  	<b>top sizes</b> to cut down any standard size top to specified dimensions add \$126 to the next highest price <b>grommets</b> reference page 168 for pricing and location of optional grommets		



veneer top SELF EDGE VS <small>TOP AND EDGE COLOR HAVE SAME FINISH</small>		veneer top WOOD EDGE VH / VI <small>TOP AND EDGE COLOR HAVE SAME FINISH</small>		laminate top SELF EDGE LS <small>SPECIFY BOTH TOP AND EDGE COLOR</small>		laminate top PVC EDGE LP <small>SPECIFY BOTH TOP AND EDGE COLOR</small>		laminate top WOOD EDGE LH / LI <small>SPECIFY BOTH TOP AND EDGE COLOR</small>	
list \$ zone 1	list \$ zone 2	list \$ zone 1	list \$ zone 2	list \$ zone 1	list \$ zone 2	list \$ zone 1	list \$ zone 2	list \$ zone 1	list \$ zone 2
1,656	1,789	1,656	1,789	661	714	778	840	814	878
-	-	-	-	774	836	893	963	-	-
1,937	2,092	-	-	661	714	778	840	-	-
-	-	-	-	774	836	893	963	-	-
463	503	463	503	258	279	381	412	423	457
463	503	463	503	258	279	381	412	423	457
644	696	644	696	142	155	207	220	223	245
644	696	644	696	281	291	410	443	446	479
-	-	-	-	493	530	642	693	993	1,078
386	412	386	412	142	155	207	220	223	245
463	503	463	503	258	279	381	412	423	457

laminates  
wood  
pattern  
  
top &  
edge  
finishes

2ML-P natural maple on birch  
3ML-P light maple on birch  
4ML-P medium maple on birch  
5ML-P cherry on birch  
6LC-P light cherry on birch  
7MC-P medium cherry on birch  
8DC-P dark cherry on birch  
CB-P cherry on birch  
EW-P eggshell white  
MB-P mocha on birch  
NB-P natural on birch









laminates  
solid &  
mixed  
colors  
  
top &  
edge  
finishes

BA CLCM  
EWGS RA  
BB CNCO  
GVNV SUTY

BLCF  
CU OS  
WH

laminates  
top &  
edge  
finishes

Designer palette (5% upcharge plus \$80 net freight charge)  
SPL special laminate, provide manufacturer and item # \_\_\_\_\_

	model number	description	d	w	h	freight
	TC2566 - _ - _	counter chassis	24	66	14	class 8585 cwt 2525 lb cu ft 2
	TC2572 - _ - _	counter chassis	24	72	14	class 85 cwt 25 lb cu ft 2
	25-302F - _ - _ - _ - _	30" deep file/file pedestal	30	15.5	27.75	class 125 cwt 105 lb cu ft 10
	25-242F - _ - _ - _ - _	24" deep file/file pedestal	24	15.5	27.75	class 125 cwt 95 lb cu ft 8
	25-303D - _ - _ - _ - _	30" deep box/box/file pedestal	30	15.5	27.75	class 125 cwt 105 lb cu ft 10
	25-243D - _ - _ - _ - _	24" deep box/box/file pedestal	24	15.5	27.75	class 125 cwt 95 lb cu ft 8
	25-24CPUR - _ - _ - _ - _ - _	24" deep cpu storage pedestal hinged right with adjustable shelf	24	15.5	27.75	class 125 cwt 85 lb cu ft 8
	25-24CPUL - _ - _ - _ - _ - _	24" deep cpu storage pedestal hinged left with adjustable shelf	24	15.5	27.75	class 125 cwt 85 lb cu ft 8

chassis options

V veneer  
D durasyn

veneer finishes

2ML-W natural maple on birch  
3ML-W light maple on birch  
4ML-W medium maple on birch  
5ML-W cherry on birch  
6LC-W light cherry on birch  
7MC-W medium cherry on birch  
8DC-W dark cherry on birch  
CB-W cherry on birch  
MB-W mocha on birch  
NB-W natural on birch

pulls

BB black bar  
CB chrome bar  
CC chrome cable

edge











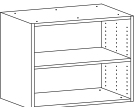

veneer chassis veneer drawer fronts		veneer chassis durasyn drawer fronts		durasyn chassis veneer drawer fronts		durasyn chassis durasyn drawer fronts	
VV		VD		DV		DD	
list \$ zone 1	list \$ zone 2	list \$ zone 1	list \$ zone 2	list \$ zone 1	list \$ zone 2	list \$ zone 1	list \$ zone 2
724	783	-	-	-	-	580	627
724	783	-	-	-	-	580	627
1,120	1,210	1,120	1,210	1,120	1,210	1,120	1,210
983	1,062	983	1,062	983	1,062	983	1,062
1,206	1,303	1,206	1,303	1,206	1,303	1,206	1,303
1,066	1,151	1,066	1,151	1,066	1,151	1,066	1,151
690	745	690	745	690	745	690	745
690	745	690	745	690	745	690	745

**durasyn**  
solid color  
match to  
laminates

- BP** black pearl
- BL** black
- CH** chinchilla
- CT** cactus
- EW** eggshell white
- FG** fog
- NB** natural beige
- NG** northsea gray
- PE** pearl
- RK** rock
- SD** sand
- ST** sunset
- TW** tumbleweed

	model number	description	d	w	h	freight
	<b>MP252F</b> - _ - _ - _ - _ -	mobile pedestal file/file drawers with locking casters for use under any 29" surface black tray top	18.9	15.6	27.3	class 125 cwt 75 lb cu ft 6
	<b>MP253D</b> - _ - _ - _ - _ -	mobile pedestal box/box/file drawers with locking casters for use under any 29" surface black tray top	18.9	15.6	27.3	class 125 cwt 75 lb cu ft 6
	<b>25-24LF</b> - _ - _ - _ - _ -	two drawer lateral file pedestal	24	36	27.75	class 125 cwt 155 lb cu ft 18
	<b>25-24HW</b> - _ - _ - _ - _ -	double hinged door cabinet one adjustable shelf  <i>SOLID WOOD SHELVES (EACH) \$28</i> <i>ADDITIONAL SHELVES (EACH) \$92</i>	24	36	27.75	class 125 cwt 115 lb cu ft 18
	<b>25-24OB</b> - _ - _ - _ - _ -	open shelf cabinet one adjustable shelf  <i>SOLID WOOD SHELVES (EACH) \$28</i> <i>ADDITIONAL SHELVES (EACH) \$92</i>	23.25	36	27.75	class 125 cwt 105 lb cu ft 17
	<b>25-202L</b> - _ - _ - _ - _ -	two drawer lateral file standard anti-tip locking mechanism	20	36	29	class 125 cwt 175 lb cu ft 16
	<b>25-203L</b> - _ - _ - _ - _ -	three drawer lateral file standard anti-tip locking mechanism	20	36	41	class 125 cwt 255 lb cu ft 25
	<b>25-204L</b> - _ - _ - _ - _ -	four drawer lateral file standard anti-tip locking mechanism	20	36	54.75	class 125 cwt 265 lb cu ft 29

chassis  
options

**V** veneer  
**D** durasyn

veneer  
finishes

**2ML-W** natural maple on birch  
**3ML-W** light maple on birch  
**4ML-W** medium maple on birch  
**5ML-W** cherry on birch  
**6LC-W** light cherry on birch  
**7MC-W** medium cherry on birch  
**8DC-W** dark cherry on birch  
**CB-W** cherry on birch  
**MB-W** mocha on birch  
**NB-W** natural on birch

pulls

**BB** black bar  
**CB** chrome bar  
**CC** chrome cable

edge









veneer chassis veneer drawer fronts		veneer chassis durasyn drawer fronts		durasyn chassis veneer drawer fronts		durasyn chassis durasyn drawer fronts	
VV		VD		DV		DD	
list \$ zone 1	list \$ zone 2	list \$ zone 1	list \$ zone 2	list \$ zone 1	list \$ zone 2	list \$ zone 1	list \$ zone 2
1,217	1,315	1,217	1,315	1,217	1,315	1,217	1,315
1,232	1,331	1,232	1,331	1,232	1,331	1,232	1,331
1,297	1,401	1,297	1,401	1,297	1,401	1,297	1,401
1,017	1,094	1,017	1,094	1,017	1,094	1,017	1,094
743	802	743	802	743	802	743	802
1,544	1,668	1,544	1,668	1,544	1,668	1,544	1,668
2,153	2,326	2,153	2,326	2,153	2,326	2,153	2,326
2,452	2,649	2,452	2,649	2,452	2,649	2,452	2,649

**durasyn**  
solid color  
match to  
laminates

- BP** black pearl
- BL** black
- CH** chinchilla
- CT** cactus
- EW** eggshell white
- FG** fog
- NB** natural beige
- NG** northsea gray
- PE** pearl
- RK** rock
- SD** sand
- ST** sunset
- TW** tumbleweed

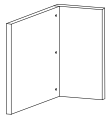
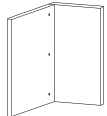
trek  
2500

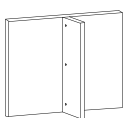
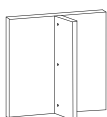
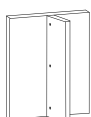

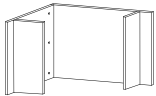
	model number	description	d	w	h	freight
	<b>25-36ES</b> - _ - _	end support unit use with rectangle and bow tops; for angled or arc returns use 36"; reversible for LH or RH applications  <i>AVAILABLE IN VENEER (V) AND DURASYN (D).</i>	36	15.5	27.75	class 85 cwt 50 lb cu ft 3
	<b>25-30ES</b> - _ - _	end support unit use with rectangle and bow tops; for angled or arc returns use 30"; reversible for LH or RH applications  <i>AVAILABLE IN VENEER (V) AND DURASYN (D).</i>	30	15.5	27.75	class 85 cwt 45 lb cu ft 3
	<b>25-24ES</b> - _ - _	end support unit use with rectangle and bow tops, for angled or arc returns use 24" reversible for LH or RH applications  <i>AVAILABLE IN VENEER (V) AND DURASYN (D).</i>	24	15.5	27.75	class 85 cwt 30 lb cu ft 3
	<b>25-36TS</b> - _ - _	36" T-support use with 36" D-tops or P-tops LH or RH applications  <i>AVAILABLE IN VENEER (V) AND DURASYN (D).</i>	13	36	27.75	class 85 cwt 50 lb cu ft 3
	<b>25-30T</b> - _ - _	30" T-support use with 30" D-tops or P-tops LH or RH applications  <i>AVAILABLE IN VENEER (V) AND DURASYN (D).</i>	13	30	27.75	class 85 cwt 45 lb cu ft 3
	<b>25-24TS</b> - _ - _	24" T-support use with 24" D-tops LH or RH applications  <i>AVAILABLE IN VENEER (V) AND DURASYN (D).</i>	13	24	27.75	class 85 cwt 30 lb cu ft 3
	<b>25-15TS</b> - _ - _	15.5" T-support use with modesty panels when span is greater than 72" LH or RH applications  <i>AVAILABLE IN VENEER (V) AND DURASYN (D).</i>	13	15.5	27.75	class 85 cwt 25 lb cu ft 2
	<b>25-42CS</b> - _ - _	corner support unit  <i>AVAILABLE IN VENEER (V) AND DURASYN (D).</i>	42	42	27.75	class 85 cwt 65 lb cu ft 9

**chassis options**

**V** veneer  
**D** durasyn

**veneer finishes**

**2ML-W** natural maple on birch  
**3ML-W** light maple on birch  
**4ML-W** medium maple on birch  
**5ML-W** cherry on birch  
**6LC-W** light cherry on birch  
**7MC-W** medium cherry on birch  
**8DC-W** dark cherry on birch  
**CB-W** cherry on birch  
**MB-W** mocha on birch  
**NB-W** natural on birch

**pulls**

**BB** black bar  
**CB** chrome bar  
**CC** chrome cable

**edge**











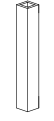

veneer chassis veneer drawer fronts		veneer chassis durasyn drawer fronts		durasyn chassis veneer drawer fronts		durasyn chassis durasyn drawer fronts	
VV		VD		DV		DD	
list \$ zone 1	list \$ zone 2	list \$ zone 1	list \$ zone 2	list \$ zone 1	list \$ zone 2	list \$ zone 1	list \$ zone 2
594	642	-	-	-	-	594	642
427	461	-	-	-	-	427	461
402	434	-	-	-	-	402	434
523	564	-	-	-	-	523	564
408	442	-	-	-	-	408	442
363	392	-	-	-	-	363	392
321	347	-	-	-	-	321	347
993	1,073	-	-	-	-	993	1,073

**durasyn**  
solid color  
match to  
laminates

- BP** black pearl
- BL** black
- CH** chinchilla
- CT** cactus
- EW** eggshell white
- FG** fog
- NB** natural beige
- NG** northsea gray
- PE** pearl
- RK** rock
- SD** sand
- ST** sunset
- TW** tumbleweed

list \$ zone 1 list \$ zone 2

	model number	description	d	w	h	freight		
	<b>25-12SL</b> - __ - __	12d support leg use as intermediate support for any work surface span of 60" or wider  <i>AVAILABLE IN VENEER (V) AND DURASYN (D).</i>	36	15.5	27.75	class 85 cwt 15 lb cu ft 0		
	<b>LB4</b>	4" metal support column  <i>FOR USE WITH P AND D TOPS BLACK ONLY</i>	4 dia		27.75	class 85 cwt 10 lb cu ft 1	<b>158</b>	<b>170</b>
	<b>PLB</b>	support column 164  <i>FOR USE WITH P AND D TOPS BLACK ONLY</i>	4 dia		27.75	class 85 cwt 10 lb cu ft 1	<b>477</b>	<b>515</b>
	<b>PDB-20</b>	support column (post disc base) powder coated "stardust" pedestal base for use with P and D tops <b>HEIGHTS:</b> 1 1/16" tops -28" height 1 1/4" tops - 27 3/4" height  <i>ALSO AVAILABLE IN BLACK</i>	4 dia		27.75	class 85 cwt 10 lb cu ft 1	<b>860</b>	<b>928</b>
	<b>25-70MP</b> - __ - __	70" modesty panel  <i>AVAILABLE IN VENEER (V) AND DURASYN (D).</i>	0.75	70	27.75	class 70 cwt 50 lb cu ft 3		
	<b>25-65MP</b> - __ - __	65" modesty panel  <i>AVAILABLE IN VENEER (V) AND DURASYN (D).</i>	0.75	65	27.75	class 70 cwt 45 lb cu ft 3		
	<b>25-59MP</b> - __ - __	59" modesty panel  <i>AVAILABLE IN VENEER (V) AND DURASYN (D).</i>	.75	59	27.75	class 70 cwt 42 lb cu ft 3		
	<b>25-53MP</b> - __ - __	53" modesty panel  <i>AVAILABLE IN VENEER (V) AND DURASYN (D).</i>	.75	53	27.75	class 70 cwt 38 lb cu ft 3		

chassis options

**V** veneer  
**D** durasyn

veneer finishes

**2ML-W** natural maple on birch  
**3ML-W** light maple on birch  
**4ML-W** medium maple on birch  
**5ML-W** cherry on birch  
**6LC-W** light cherry on birch  
**7MC-W** medium cherry on birch  
**8DC-W** dark cherry on birch  
**CB-W** cherry on birch  
**MB-W** mocha on birch  
**NB-W** natural on birch

pulls

**BB** black bar  
**CB** chrome bar  
**CC** chrome cable

edge











veneer chassis veneer drawer fronts		veneer chassis durasyn drawer fronts		durasyn chassis veneer drawer fronts		durasyn chassis durasyn drawer fronts	
VV		VD		DV		DD	
list \$ zone 1	list \$ zone 2	list \$ zone 1	list \$ zone 2	list \$ zone 1	list \$ zone 2	list \$ zone 1	list \$ zone 2
181	196	-	-	-	-	181	196
-	-	-	-	-	-	-	-
-	-	-	-	-	-	-	-
-	-	-	-	-	-	-	-
503	542	-	-	-	-	503	542
446	480	-	-	-	-	446	480
381	412	-	-	-	-	381	412
284	306	-	-	-	-	284	306

**durasyn**  
solid color  
match to  
laminates

- BP** black pearl
- BL** black
- CH** chinchilla
- CT** cactus
- EW** eggshell white
- FG** fog
- NB** natural beige
- NG** northsea gray
- PE** pearl
- RK** rock
- SD** sand
- ST** sunset
- TW** tumbleweed

trek  
2500

	model number	description	d	w	h	freight		
	<b>25-47MP</b> - ___ - ___	47" modesty panel  <i>AVAILABLE IN VENEER (V) AND DURASYN (D).</i>	.75	47	27.75	class 70 cwt 35 lb cu ft 2		
	<b>25-41MP</b> - ___ - ___	41" modesty panel  <i>AVAILABLE IN VENEER (V) AND DURASYN (D).</i>	.75	41	27.75	class 70 cwt 30 lb cu ft 2		
	<b>25-35MP</b> - ___ - ___	35" modesty panel  <i>AVAILABLE IN VENEER (V) AND DURASYN (D).</i>	.75	35	27.75	class 70 cwt 25 lb cu ft 2		
	<b>25-29MP</b> - ___ - ___	29" modesty panel  <i>AVAILABLE IN VENEER (V) AND DURASYN (D).</i>	.75	29	27.75	class 70 cwt 20 lb cu ft 2		
	<b>25-25MP</b> - ___ - ___	25" modesty panel  <i>AVAILABLE IN VENEER (V) AND DURASYN (D).</i>	.75	25	27.75	class 70 cwt 17 lb cu ft 2		
	<b>25-19MP</b> - ___ - ___	19" modesty panel  <i>AVAILABLE IN VENEER (V) AND DURASYN (D).</i>	.75	19	27.75	class 70 cwt 15 lb cu ft 0		
	<b>25-MPK</b>  <i>MUST SPECIFY SEPARATELY</i>	mend plate kit (set of 2) use when attaching two work surfaces together - black finish				class 125 cwt 0 lb cu ft 0	<b>11</b>	<b>11</b>

### chassis options

**V** veneer  
**D** durasyn

### veneer finishes

**2ML-W** natural maple on birch  
**3ML-W** light maple on birch  
**4ML-W** medium maple on birch  
**5ML-W** cherry on birch  
**6LC-W** light cherry on birch  
**7MC-W** medium cherry on birch  
**8DC-W** dark cherry on birch  
**CB-W** cherry on birch  
**MB-W** mocha on birch  
**NB-W** natural on birch

### pulls

**BB** black bar  
**CB** chrome bar  
**CC** chrome cable

### edge



**modesty** Special orders: to cut down any standard size modesty panel to specified dimension add \$298 to the next highest price



veneer chassis veneer drawer fronts		veneer chassis durasyn drawer fronts		durasyn chassis veneer drawer fronts		durasyn chassis durasyn drawer fronts	
VV		VD		DV		DD	
list \$ zone 1	list \$ zone 2	list \$ zone 1	list \$ zone 2	list \$ zone 1	list \$ zone 2	list \$ zone 1	list \$ zone 2
241	260	-	-	-	-	241	260
215	233	-	-	-	-	215	233
190	205	-	-	-	-	190	205
174	188	-	-	-	-	174	188
166	181	-	-	-	-	166	181
137	147	-	-	-	-	137	147

trek  
2500

**durasyn**  
solid color  
match to  
laminates

- BP** black pearl
- BL** black
- CH** chinchilla
- CT** cactus
- EW** eggshell white
- FG** fog
- NB** natural beige
- NG** northsea gray
- PE** pearl
- RK** rock
- SD** sand
- ST** sunset
- TW** tumbleweed



top application	top size	end support	t support	support leg	bracket kit	modesty panel
return	<b>25-36T</b>	n/a	n/a	n/a	(1) ESHK & (1) PHK	25-25MP
bridge	<b>25-36T</b>	n/a	n/a	n/a	(2) ESHK	25-41MP
return	<b>25-42T</b>	n/a	n/a	n/a	(1) ESHK & (1) PHK	25-29MP
bridge	<b>25-42T</b>	n/a	n/a	n/a	(2) ESHK	25-47MP
single pedestal desk	<b>25-48T</b>	25-ES	n/a	n/a	(1) ESHK & (1) PHK	25-25MP
return	<b>25-48T</b>	n/a	n/a	n/a	(1) ESHK & (1) PHK	25-35MP
bridge	<b>25-48T</b>	n/a	n/a	n/a	(2) ESHK	25-53MP
single pedestal desk	<b>25-54T</b>	25-ES	n/a	n/a	(1) ESHK & (1) PHK	25-25MP
return	<b>25-54T</b>	n/a	n/a	n/a	(1) ESHK & (1) PHK	25-41MP
bridge	<b>25-54T</b>	n/a	n/a	n/a	(2) ESHK	25-59MP
double pedestal desk	<b>25-60T</b>	n/a	n/a	n/a	(2) PHK	25-29MP
single pedestal desk	<b>25-60T</b>	25-ES	n/a	n/a	(1) ESHK & (1) PHK	25-35MP
return	<b>25-60T</b>	n/a	n/a	n/a	(1) ESHK & (1) PHK	25-47MP
bridge	<b>25-60T</b>	n/a	n/a	25-12SL	(2) ESHK	25-65MP
double pedestal desk	<b>25-66T</b>	n/a	n/a	n/a	(2) PHK	25-35MP
single pedestal desk	<b>25-66T</b>	25-ES	n/a	n/a	(1) ESHK & (1) PHK	25-41MP
return	<b>25-66T</b>	n/a	n/a	n/a	(1) ESHK & (1) PHK	25-53MP
bridge	<b>25-66T</b>	n/a	n/a	25-12SL	(2) ESHK	25-70MP
double pedestal desk	<b>25-72T</b>	n/a	n/a	n/a	(2) PHK	25-41MP
single pedestal desk	<b>25-72T</b>	25-ES	n/a	n/a	(1) ESHK & (1) PHK	25-47MP
return	<b>25-72T</b>	n/a	n/a	25-12SL	(1) ESHK & (1) PHK	25-59MP
bridge	<b>25-72T</b>	n/a	25-15TS	n/a	(4) ESHK	(2) 25-35MP
double pedestal desk	<b>25-78T</b>	n/a	n/a	n/a	(2) PHK	25-47MP
single pedestal desk	<b>25-78T</b>	25-ES	n/a	n/a	(1) ESHK & (1) PHK	25-53MP
return	<b>25-78T</b>	n/a	n/a	25-12SL	(1) ESHK & (1) PHK	25-65MP
bridge	<b>25-78T</b>	n/a	25-15TS	n/a	(4) ESHK	(2) 25-35MP
double pedestal desk	<b>25-84T</b>	n/a	n/a	n/a	(2) PHK	25-53MP
single pedestal desk	<b>25-84T</b>	25-ES	n/a	n/a	(1) ESHK & (1) PHK	25-59MP
return	<b>25-84T</b>	n/a	25-15TS	n/a	(3) ESHK & (1) PHK	25-65MP
bridge	<b>25-84T</b>	n/a	25-15TS	n/a	(4) ESHK	(2) 25-41MP
double pedestal desk	<b>25-90T</b>	n/a	n/a	25-12SL	(2) PHK	25-59MP
single pedestal desk	<b>25-90T</b>	25-ES	25-15TS	n/a	(1) ESHK & (1) PHK	(2) 25-29MP
return	<b>25-90T</b>	n/a	25-15TS	n/a	(3) ESHK & (1) PHK	(2) 25-35MP
bridge	<b>25-90T</b>	n/a	25-15TS	n/a	(4) ESHK	(2) 25-41MP
double pedestal desk	<b>25-96T</b>	n/a	n/a	25-12SL	(2) PHK	25-65MP
single pedestal desk	<b>25-96T</b>	25-ES	25-15TS	n/a	(1) ESHK & (1) PHK	(2) 25-29MP
return	<b>25-96T</b>	n/a	25-15TS	n/a	(3) ESHK & (1) PHK	(2) 25-35MP
bridge	<b>25-96T</b>	n/a	25-15TS	n/a	(4) ESHK	(2) 25-47MP

trek

| 2500 series



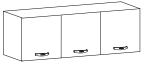
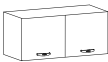
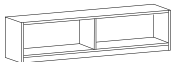
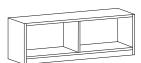

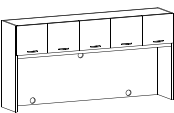
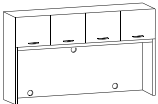
	model number	description	d	w	h	freight
	<b>25-WH66</b> - _ - - _ - _ - _ -	66" wide wall hung overhead 4 wood doors	16	66	16	class 125 cwt 110 lb cu ft 13
	<b>25-WH48</b> - _ - - _ - _ - _ -	48" wide wall hung overhead 3 wood doors	16	48	16	class 125 cwt 90 lb cu ft 10
	<b>25-WH36</b> - _ - - _ - _ - _ -	36" wide wall hung overhead 2 wood doors	16	36	16	class 125 cwt 75 lb cu ft 8
	<b>25-WHO66</b> - _ - - _ - _ - _ -	66" wide wall hung overhead open	15.25	66	16	class 125 cwt 90 lb cu ft 13
	<b>25-WHO48</b> - _ - - _ - _ - _ -	48" wide wall hung overhead open	15.25	48	16	class 125 cwt 75 lb cu ft 10
	<b>25-WHO36</b> - _ - - _ - _ - _ -	36" wide wall hung overhead open	15.25	36	16	class 125 cwt 65 lb cu ft 8
	<b>OU2584</b> - _ - - _ - _ - _ -	84" overhead storage unit five hinged doors three wire management grommets	16.5	83.75	42.5	class 125 cwt 205 lb cu ft 40 opening: 25.9"
	<b>OU2572</b> - _ - - _ - _ - _ -	72" overhead storage unit four hinged doors three wire management grommets	16.5	72	42.5	class 125 cwt 205 lb cu ft 40 opening: 25.9"

**chassis options**

**V** veneer  
**D** durasyn

**veneer finishes**

**2ML-W** natural maple on birch  
**3ML-W** light maple on birch  
**4ML-W** medium maple on birch  
**5ML-W** cherry on birch  
**6LC-W** light cherry on birch  
**7MC-W** medium cherry on birch  
**8DC-W** dark cherry on birch  
**CB-W** cherry on birch  
**MB-W** mocha on birch  
**NB-W** natural on birch

**pulls**

**BB** black bar  
**CB** chrome bar  
**CC** chrome cable

**edge**





chemcast doors in place of wood doors  
2 doors \$228 list up charge  
3-4 doors \$360 list up charge



veneer chassis veneer drawer fronts		veneer chassis durasyn drawer fronts		durasyn chassis veneer drawer fronts		durasyn chassis durasyn drawer fronts	
VV		VD		DV		DD	
list \$ zone 1	list \$ zone 2	list \$ zone 1	list \$ zone 2	list \$ zone 1	list \$ zone 2	list \$ zone 1	list \$ zone 2
1,792	1,935	1,792	1,935	1,792	1,935	1,792	1,935
1,541	1,665	1,541	1,665	1,541	1,665	1,541	1,665
1,010	1,090	1,010	1,090	1,010	1,090	1,010	1,090
1,327	1,433	-	-	-	-	1,327	1,433
1,128	1,218	-	-	-	-	1,128	1,218
872	942	-	-	-	-	872	942
3,322	3,588	3,322	3,588	3,322	3,588	3,322	3,588
2,571	2,770	2,571	2,770	2,571	2,770	2,571	2,770

**durasyn**  
solid color  
match to  
laminates

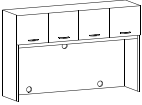
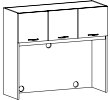
- BP** black pearl
- BL** black
- CH** chinchilla
- CT** cactus
- EW** eggshell white
- FG** fog
- NB** natural beige
- NG** northsea gray
- PE** pearl
- RK** rock
- SD** sand
- ST** sunset
- TW** tumbleweed

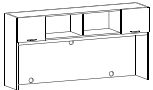
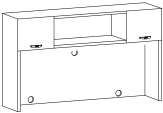
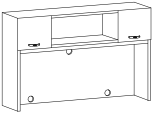
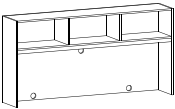
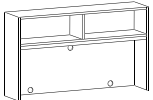
	model number	description	d	w	h	freight
	<b>OU2566</b> - __ - __ - __ - __	66" overhead storage unit four hinged doors three wire management grommets	16.5	66	42.5	class 125 cwt 175 lb cu ft 38
	<b>OU2548</b> - __	48" overhead storage unit three hinged doors three wire management grommets	16.5	48	42.5	class 125 cwt 150 lb cu ft 26
	<b>OU2536</b> - __	36" overhead storage unit two hinged doors two wire management grommets	16.5	36	42.5	class 125 cwt 115 lb cu ft 19
	<b>OD2584</b> - __ - __	84" overhead storage unit open center, one hinged door on each end three wire management grommets	16.5	83.75	42.5	class 125 cwt 185 lb cu ft 40
	<b>OD2572</b> - __ - __ - __ - __	72" overhead storage unit with open center, one hinged door on each end with three wire management grommets	16.5	72	42.5	class 125 cwt 195 lb cu ft 40
	<b>OD2566</b> - __ - __ - __ - __	66" overhead storage unit with open center, one hinged door on each end with three wire management grommets	16.5	66	42.5	class 125 cwt 165 lb cu ft 38
	<b>OO2584</b> - __ - __	84" open overhead storage unit with three wire management grommets	16.5	83.75	42.5	class 125 cwt 185 lb cu ft 40
	<b>OO2572</b> - __ - __	72" open overhead storage unit three wire management grommets	16.5	72	42.5	class 125 cwt 185 lb cu ft 40

**chassis  
options**

**V** veneer  
**D** durasyn

**veneer  
finishes**

**2ML-W** natural maple on birch  
**3ML-W** light maple on birch  
**4ML-W** medium maple on birch  
**5ML-W** cherry on birch  
**6LC-W** light cherry on birch  
**7MC-W** medium cherry on birch  
**8DC-W** dark cherry on birch  
**CB-W** cherry on birch  
**MB-W** mocha on birch  
**NB-W** natural on birch

**pulls**

**BB** black bar  
**CB** chrome bar  
**CC** chrome cable

**edge**



chemcast doors in place of wood doors  
2 doors \$228 list up charge  
3-4 doors \$360 list up charge







veneer chassis veneer drawer fronts		veneer chassis durasyn drawer fronts		durasyn chassis veneer drawer fronts		durasyn chassis durasyn drawer fronts	
VV		VD		DV		DD	
list \$ zone 1	list \$ zone 2	list \$ zone 1	list \$ zone 2	list \$ zone 1	list \$ zone 2	list \$ zone 1	list \$ zone 2
2,484	2,676	2,484	2,676	2,484	2,676	2,484	2,676
1,913	2,068	1,913	2,068	1,913	2,068	1,913	2,068
1,558	1,836	1,558	1,836	1,558	1,836	1,558	1,836
3,094	3,341	3,094	3,341	3,094	3,341	3,094	3,341
2,418	2,611	2,418	2,611	2,418	2,611	2,418	2,611
2,314	2,500	2,314	2,500	2,314	2,500	2,314	2,500
2,667	2,880	-	-	-	-	2,667	2,880
1,916	2,070	-	-	-	-	1,916	2,070

**durasyn**  
solid color  
match to  
laminates

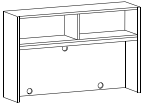
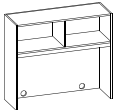
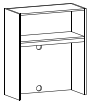
- BP** black pearl
- BL** black
- CH** chinchilla
- CT** cactus
- EW** eggshell white
- FG** fog
- NB** natural beige
- NG** northsea gray
- PE** pearl
- RK** rock
- SD** sand
- ST** sunset
- TW** tumbleweed

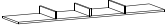
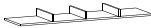
trek  
2500

	model number	description	d	w	h	freight
	<b>OO2566</b> - ___ - ___	66" open overhead storage unit with three wire management grommets	16.5	66	42.5	class 125 cwt 155 lb cu ft 38 opening: 25.9"
	<b>OO2548</b> - ___	48" open overhead storage unit with three wire management grommets	16.5	48	42.5	class 125 cwt 150 lb cu ft 26 opening: 25.9"
	<b>OO2536</b> - ___	36" open overhead storage unit with two wire management grommets	16.5	36	42.5	class 125 cwt 115 lb cu ft 19 opening: 25.9"
	<b>USU84</b> - ___	underside paper storage for use with 84" overhead storage unit; does not prevent the use of task light or tackboards <i>NOT AVAILABLE ON WALL MOUNT UNITS</i>	15.75	82	3.25	class 125 cwt 115 lb cu ft 19
	<b>USU72</b> - ___	underside paper storage for use with 72" overhead storage units; does not prevent the use of a task light over tackboard. <i>NOT AVAILABLE ON WALL MOUNT UNITS</i> <i>FACTORY INSTALLED</i>	15.75	70	3.25	class 125 cwt 10 lb cu ft 0
	<b>USU66</b> - ___	underside paper storage for use with 66" overhead storage units; does not prevent the use of a task light over tackboard <i>NOT AVAILABLE ON WALL MOUNT UNITS</i> <i>FACTORY INSTALLED</i>	15.75	64	3.25	class 125 cwt 10 lb cu ft 0
	<b>USU48</b> - ___	underside paper storage for use with 48" overhead storage units; does not prevent use of task light or tackboards <i>NOT AVAILABLE ON WALL MOUNT UNITS</i> <i>FACTORY INSTALLED</i>	15.75	46	3.25	class 125 cwt 10 lb cu ft 15
	<b>USU36</b> - ___	underside paper storage for use with 36" overhead storage unit; does not prevent the use of task lights or tackboards <i>NOT AVAILABLE ON WALL MOUNT UNITS</i> <i>FACTORY INSTALLED</i>	15.75	34	3.25	class 125 cwt 8 lb cu ft 8

chassis options

**V** veneer  
**D** durasyn

veneer finishes

**2ML-W** natural maple on birch  
**3ML-W** light maple on birch  
**4ML-W** medium maple on birch  
**5ML-W** cherry on birch  
**6LC-W** light cherry on birch  
**7MC-W** medium cherry on birch  
**8DC-W** dark cherry on birch  
**CB-W** cherry on birch  
**MB-W** mocha on birch  
**NB-W** natural on birch

pulls

**BB** black bar  
**CB** chrome bar  
**CC** chrome cable

edge



chemcast doors in place of wood doors  
2 doors \$228 list up charge  
3-4 doors \$360 list up charge



veneer chassis veneer drawer fronts		veneer chassis durasyn drawer fronts		durasyn chassis veneer drawer fronts		durasyn chassis durasyn drawer fronts	
VV		VD		DV		DD	
list \$ zone 1	list \$ zone 2	list \$ zone 1	list \$ zone 2	list \$ zone 1	list \$ zone 2	list \$ zone 1	list \$ zone 2
1,845	1,992	-	-	-	-	1,845	1,992
1,432	1,546	-	-	-	-	1,432	1,546
1,237	1,335	-	-	-	-	1,237	1,335
512	554	-	-	-	-	512	554
498	536	-	-	-	-	498	536
498	536	-	-	-	-	498	536
292	315	-	-	-	-	292	315
292	315	-	-	-	-	292	315

**durasyn**  
solid color  
match to  
laminates

- BP** black pearl
- BL** black
- CH** chinchilla
- CT** cactus
- EW** eggshell white
- FG** fog
- NB** natural beige
- NG** northsea gray
- PE** pearl
- RK** rock
- SD** sand
- ST** sunset
- TW** tumbleweed

	model number	description	d	w	h	freight
	PSU - _ _	personal storage unit can be positioned horizontally or vertically	12	15.5	21.75	class 125 cwt 20 lb cu ft 2
	HO2536 - _ _ - _ _	open hutch <i>FOR USE WITH HW OR 2FD UNITS</i> SOLID WOOD SHELVES (EACH) \$28 ADDITIONAL SHELVES (EACH) \$92	16.5	36	42.5	class 125 cwt 90 lb cu ft 19
	HW2536 - _ _ - _ _	hutch with two doors two adjustable shelves SOLID WOOD SHELVES (EACH) \$28 ADDITIONAL SHELVES (EACH) \$92	17.25	36	42.5	class 125 cwt 90 lb cu ft 19
	CUH2542 - _ _ - _ _	corner hutch <i>TO SET CORNER TOPS</i>	42	42	29	class 125 cwt 145 lb cu ft 9
	WD2572 - _ _ - _ _ - _ _ - _ _	wardrobe/storage cabinet one side coat storage one side three adjustable shelves storage shelf above SOLID WOOD SHELVES (EACH) \$28 ADDITIONAL SHELVES (EACH) \$92	24	36	72	class 125 cwt 320 lb cu ft 42
	WD2572(R/L)-18 - _ _	wardrobe/storage cabinet (R) right side hinge/left side knob (L) left side hinge/right side knob SOLID WOOD SHELVES (EACH) \$28 ADDITIONAL SHELVES (EACH) \$92	24	18	72	class 125 cwt 170 lb cu ft 23
	HW257222F - _ _ - _ _ - _ _ - _ _	hinged door cabinet two adjustable shelves lateral file below SOLID WOOD SHELVES (EACH) \$28 ADDITIONAL SHELVES (EACH) \$92	24	36	72	class 125 cwt 320 lb cu ft 43
	HW2572HW - _ _ - _ _ - _ _ - _ _	hinged door cabinet (above and below) two adjustable shelves upper one adjustable shelf below SOLID WOOD SHELVES (EACH) \$28 ADDITIONAL SHELVES (EACH) \$92	24	36	72	class 125 cwt 270 lb cu ft 43

chassis options

V veneer  
D durasyn

veneer finishes

2ML-W natural maple on birch  
3ML-W light maple on birch  
4ML-W medium maple on birch  
5ML-W cherry on birch  
6LC-W light cherry on birch  
7MC-W medium cherry on birch  
8DC-W dark cherry on birch  
CB-W cherry on birch  
MB-W mocha on birch  
NB-W natural on birch

pulls

BB black bar  
CB chrome bar  
CC chrome cable

edge







veneer chassis veneer drawer fronts		veneer chassis durasyn drawer fronts		durasyn chassis veneer drawer fronts		durasyn chassis durasyn drawer fronts	
VV		VD		DV		DD	
list \$ zone 1	list \$ zone 2	list \$ zone 1	list \$ zone 2	list \$ zone 1	list \$ zone 2	list \$ zone 1	list \$ zone 2
675	728	-	-	-	-	675	728
1,495	1,703	-	-	-	-	1,495	1,703
1,942	2,106	1,942	2,106	1,942	2,106	1,942	2,106
1,749	1,928	-	-	-	-	1,749	1,928
3,602	3,879	3,602	3,879	3,602	3,879	3,602	3,879
2,592	2,847	2,592	2,847	2,592	2,847	2,592	2,847
4,770	5,151	4,770	5,151	4,770	5,151	4,770	5,151
4,980	5,384	4,980	5,384	4,980	5,384	4,980	5,384

**durasyn**  
solid color  
match to  
laminates

- BP** black pearl
- BL** black
- CH** chinchilla
- CT** cactus
- EW** eggshell white
- FG** fog
- NB** natural beige
- NG** northsea gray
- PE** pearl
- RK** rock
- SD** sand
- ST** sunset
- TW** tumbleweed



	model number	description	d	w	h	freight
	<b>AV25722F</b> - - - - - - - - -	tv cabinet pocket doors pull-out swivel TV tray lateral file below	24	36	72	class 125 cwt 340 lb cu ft 43
	<b>AV2572HW</b> - - - - - - - - -	tv cabinet upper pocket doors, pull-out swivel TV tray, hinged door cabinet below one adjustable shelf  <i>SOLID WOOD SHELVES (EACH) \$28</i> <i>ADDITIONAL SHELVES (EACH) \$92</i>	24	36	72	class 125 cwt 290 lb cu ft 43

chassis  
options

**V** veneer  
**D** durasyn

veneer  
finishes

**2ML-W** natural maple on birch  
**3ML-W** light maple on birch  
**4ML-W** medium maple on birch  
**5ML-W** cherry on birch  
**6LC-W** light cherry on birch  
**7MC-W** medium cherry on birch  
**8DC-W** dark cherry on birch  
**CB-W** cherry on birch  
**MB-W** mocha on birch  
**NB-W** natural on birch

pulls

**BB** black bar  
**CB** chrome bar  
**CC** chrome cable

edge











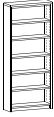

veneer chassis veneer drawer fronts		veneer chassis durasyn drawer fronts		durasyn chassis veneer drawer fronts		durasyn chassis durasyn drawer fronts	
VV		VD		DV		DD	
list \$ zone 1	list \$ zone 2	list \$ zone 1	list \$ zone 2	list \$ zone 1	list \$ zone 2	list \$ zone 1	list \$ zone 2
5,957	6,433	5,957	6,433	5,957	6,433	5,957	6,433
5,754	6,217	5,754	6,217	5,754	6,217	5,754	6,217

**durasyn**  
solid color  
match to  
laminates

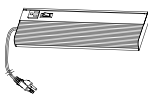
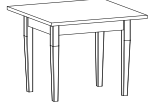
- BP** black pearl
- BL** black
- CH** chinchilla
- CT** cactus
- EW** eggshell white
- FG** fog
- NB** natural beige
- NG** northsea gray
- PE** pearl
- RK** rock
- SD** sand
- ST** sunset
- TW** tumbleweed

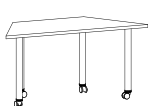
	model number	description	d	w	h	freight	list \$ zone 1	zone 2
	BC2584 - _ - _	bookcase four adjustable shelves one fixed shelf in center  <small>NO TOPS ON UNITS USE PAGE 140 TOPS TO COMPLETE UNIT SOLID WOOD SHELVES (EACH) \$28 ADDITIONAL SHELVES (EACH) \$92</small>	12	36	84	class 125 cwt 155 lb cu ft 28	1,283	1,376
	BC2572 - _ - _	bookcase three adjustable shelves one fixed shelf in center  <small>NO TOPS ON UNITS USE PAGE 140 TOPS TO COMPLETE UNIT SOLID WOOD SHELVES (EACH) \$28 ADDITIONAL SHELVES (EACH) \$92</small>	12	36	72	class 125 cwt 145 lb cu ft 24	1,055	1,187
	BC2560 - _ - _	bookcase two adjustable shelves one fixed shelf in center  <small>NO TOPS ON UNITS USE PAGE 140 TOPS TO COMPLETE UNIT SOLID WOOD SHELVES (EACH) \$28 ADDITIONAL SHELVES (EACH) \$92</small>	12	36	60	class 125 cwt 115 lb cu ft 20	988	1,059
	BC2548 - _ - _	bookcase one adjustable shelf one fixed shelf  <small>NO TOPS ON UNITS USE PAGE 140 TOPS TO COMPLETE UNIT SOLID WOOD SHELVES (EACH) \$28 ADDITIONAL SHELVES (EACH) \$92</small>	12	36	48	class 125 cwt 96 lb cu ft 16	824	883
	BC2536 - _ - _	bookcase two adjustable shelves  <small>NO TOPS ON UNITS USE PAGE 140 TOPS TO COMPLETE UNIT SOLID WOOD SHELVES (EACH) \$28 ADDITIONAL SHELVES (EACH) \$92</small>	12	36	36	class 125 cwt 85 lb cu ft 12	681	742
	BC2530 - _ - _	bookcase one adjustable shelf  <small>NO TOPS ON UNITS USE PAGE 140 TOPS TO COMPLETE UNIT solid wood shelves (each) \$28 additional shelves (each) \$92</small>	12	36	30	class 125 cwt 80 lb cu ft 11	633	679
	TL24	task light 343 for use with overhead storage units  field instaleld only	7	24	2	class 100 cwt 11 lb cu ft 1	335	364
	SP36 - _ - _	square table with laminate top, PVC edge hardwood frame with apron shown with LT (set of 4 legs)	36	36	0	class 125 cwt 40 lb cu ft 16	793	855
	CLV48 - _ - _	clover table with veneer top/self edge shown with CX-38 base	dia	48		class 125 cwt 55 lb cu ft 30	2,353	2,516
	TRS60 - _ - _	trapezoid table with laminate top and self edge shown with LB2-C (post leg with black casters) as base	60	30		class 125 cwt 65 lb cu ft 16	984	1,055

chassis VV veneer  
DD durasyn

edge



trek

| 2500 series

| bookcases/ options



---

model number	description	d	w	h	freight	list \$ zone 1	list \$ zone 2
--------------	-------------	---	---	---	---------	----------------	----------------

trek  
2500

---

**W** veneer  
**DD** durasyn

**modesty** Special orders: to cut down any standard size modesty panel to specified dimension add \$126 to the next highest price

edge



## -VV-6C

unit identification (type) & dimension - chassis option - chassis finish

**application 1**  
double pedestal desk



**mounting method:**

modesty panel butts into storage pedestal left and right

**components specified:**

work surface, left and right pedestals and modesty panel

**top size:**

top width 72"  
pedestal width minus 15.5"  
pedestal width minus 15.5"  
equal 41"

modesty panel size.....41"

**included kits**

**quantity**

2

**application 2**  
single pedestal unit



**mounting method:**

modesty panel butts into storage pedestal and overlaps end support unit. END SUPPORT OVERLAP IS A MINIMUM OF 2"

**components specified:**

work surface, pedestal, end support and modesty panel

**top size:**

top width 72"  
pedestal width minus 15.5"  
end support width minus 15.5"  
equal 41"

END SUPPORT OVERLAP IS A MINIMUM OF 2"

minimum modesty panel size 43"

specify modesty panel .....47"

**included kits**

**quantity**

PHK 1  
ESHK 2

"I" unit - return

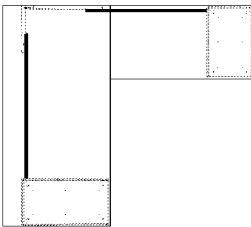

**mounting method:**

modesty panel butts into storage pedestal and overlaps end support unit. END SUPPORT OVERLAP IS A MINIMUM OF 2"

**components specified:**

desk and return top, desk and return pedestals, end support, desk modesty panel (see 2), return modesty panel

**top size:**

return top width 48"  
pedestal width minus 15.5"  
equal 31.5"

minimum modesty panel size 33.5"

specify modesty panel .....35"

**included kits**

**quantity**

PHK 2  
ESHK 2

**chassis** | **VV** veneer  
**DD** durasyn

**modesty** Special orders: to cut down any standard size modesty panel to specified dimension add \$116 to the next highest price  
**PHK** pedestal hardware mounting kit  
**ESHK** end support hardware kit





**application 4**

"u" unit - bridge

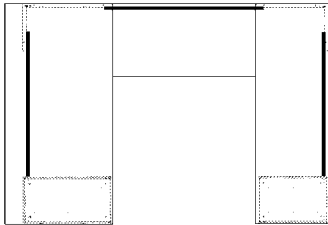

**mounting method:**

modesty panel overlaps both end support units.  
END SUPPORT OVERLAP IS A MINIMUM OF 4" (2"+2")

desk, bridge and credenza top, desk and credenza pedestals, end supports, desk modesty panel (see 2) credenza modesty panel (see 2), return modesty

**top size:**

top width 48"  
minimum overlap plus 2"  
minimum overlap plus 2"  
equal 52"

minimum modesty panel size 52"

specify modesty panel .....53"

**included kits**

included kits	quantity
PHK	2
ESHK	2

**application 5**

corner unit with standard pedestal returns

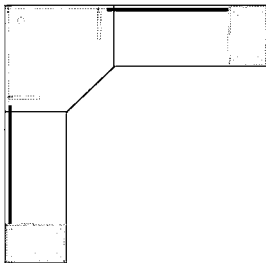

**mounting method:**

modesty panel butts into storage pedestal and overlaps corner support unit. END SUPPORT OVERLAP IS A MINIMUM OF 2" BUT NO MORE THAN 5"

**components specified:**

corner and return tops, pedestals, corner support and modesty panels

**top size:**

return top width 60"  
pedestal width minus 15.5"  
minimum overlap plus 2"  
equal 46.5"

minimum modesty panel size 46.5"

specify modesty panel .....47"

**included kits**

included kits	quantity
PHK	2
ESHK	2

**application 6**

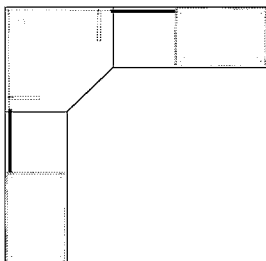

**mounting method:**

modesty panel butts into storage pedestal and overlaps corner support unit. END SUPPORT OVERLAP IS A MINIMUM OF 2" BUT NO MORE THAN 5"

**components specified:**

corner and return tops, pedestals, corner support and modesty panels

**top size:**

**included kits**

included kits	quantity
PHK	2
ESHK	2

**center location**

all widths, 24" & 30" depths

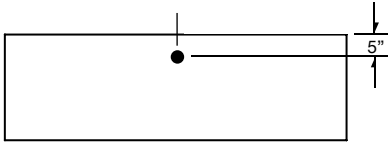

all widths, 36" depth

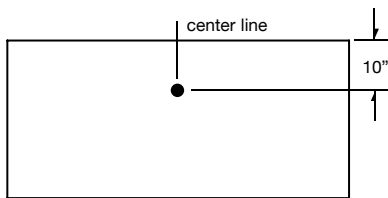

72" & 78" widths, 36" & 42" depth

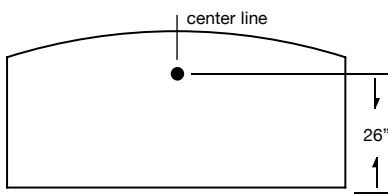

**left and right locations**

60" widths or larger, 24" & 30" depths

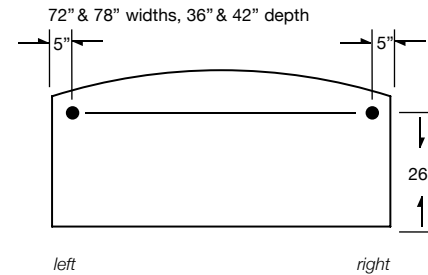
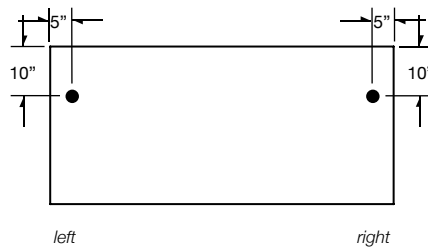
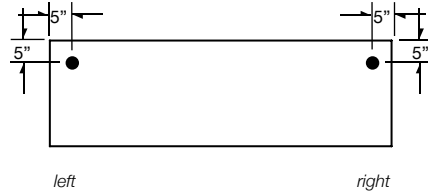

bullet tops and left & right "p" tops  
all widths and depths

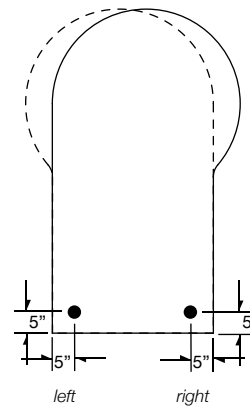

trek  
2500

top

**P** laminate top  
**W** veneer top

**grommets** to specify: at the end of the work surface model number add optional grommet location  
**L** = left **R** = right **C** = center add \$154 list per grommet.  
grommets cannot be used above full-depth pedestals, lateral files or storage cabinets.

edge



trek

| 2500 series





# inwood

OFFICE  
ENVIRONMENTS

## price list

effective 01 january 2012

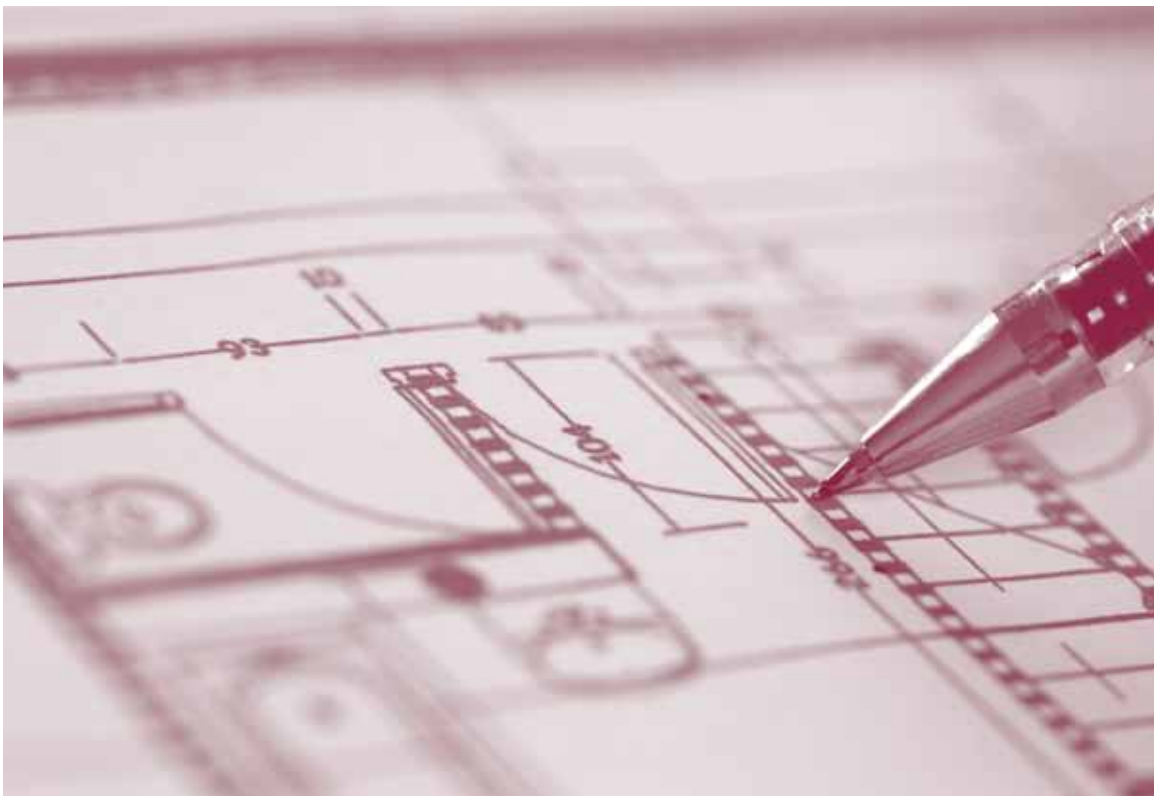

account # \_\_\_\_\_  
discount \_\_\_\_\_  
zone \_\_\_\_\_  
c.s.r. \_\_\_\_\_  
sales rep. \_\_\_\_\_

brio  
2200

[click here for warranty  
and terms information](#)

zones one and two



# inwood

OFFICE  
ENVIRONMENTS

---



Brio  
2200

## brio 2200 series specifications

### materials:

All wood is thoroughly air and kiln dried to a moisture content not to exceed 8% at the time of assembly.

### veneers:

All exposed surfaces are rotary sliced Birch. Veneers are carefully slip-matched and balanced. All drawer fronts, doors, end panels, and modesty panels are vertical grain.

### top work surfaces:

Wood veneer tops are 1 1/16" thick, 3-ply construction; consisting of 1/40" thick Birch veneer work surface and a Gator-ply backing. Laminate tops are 1 1/4" thick, 3-ply construction consisting of high pressure laminate work surface and a Gator-ply backing. The top core material is a 45 lb medium density fiberboard, with flat edge.

### modesty panels:

Suspended by 2, 1 1/16" - 2 1/4" 915 brackets, a wood frame with inserts being 1/8" thick, 3-ply construction with options of vertical veneer inserts (w), laminate inserts (l), Chemcast™\* (c), Durasyn™\* (d), or fabric (f) on exposed surfaces and a 45 lb density particle board core. When ordering place the respective letter on the product code and in the description explain what color is desired. Inside (user side) or inside door of unit will be the color of the unit (unless otherwise specified or if material is transparent/Chemcast).

### \*Chemcast™:

Cell cast acrylic sheet including clears and colors. This is a lightweight, rigid thermoplastic material that has many times the breakage resistance of glass. It is ultraviolet light absorbing and therefore very weather resistant withstanding exposure for many years without losing its surface gloss or mechanical properties. Thickness varies by color. Clear Chemcast has a light transmittance of 92%. Color densities have a light transmittance of 6% to 79%.

### \*Durasyn™:

Durasyn is a tinted painted finish with post-catalyzed varnish and acid cured topcoats formulated for superior performance on MDF. Durasyn offers superior scratch, mar, chemical and moisture resistance properties. Durasyn has been enhanced with UV absorbers to further increase UV protection.

### construction:

Uses a mortise and tenon and glue to join pedestal sides and back. All joints are reinforced with glue blocks. All bookcase shelves are standard 3/4" thick. All pedestals have box drawer, file drawer, with an aluminum finish pull standard. Each pedestal has a lock and is keyed alike.

### drawers:

Drawer fronts are 3/4" thick, 3-ply construction with vertical slip-matched veneer. Drawer edges are squared with matching maple veneer tape on all edges. All drawer sides and backs are plywood, dovetailed front and back with 3-ply drawer bottoms. Drawer bottoms are framed on four sides and stapled from the bottom side. Drawer interiors are finished with a clear coat sealer to prevent swelling or shrinkage. Box drawers have a high grade Sterling metal ball-bearing drawer suspension. File drawers have a high grade Sterling metal ball bearing full progressive suspension and are equipped with metal rods for hanging file folders. All drawers have smooth quiet operation.

*NOTE: Optional center drawers available.*

### inside drawer dimensions:

box drawers: 4" H x 14 5/8" W x 15 9/16" L

4" H x 14 5/8" W x 22 1/8" L

file drawers: 9 1/2" H x 14 5/8" W x 15 9/16" L

9 1/2" H x 14 5/8" W x 25 3/8" L

lateral files: 9 1/2" H x 32 5/8" W x 16" L

### locking:

Each pedestal has its own lock and is keyed alike on each unit. Each unit is equipped with two keys. Units may be keyed alike in groups (per office, if requested at an up charge)

### finish:

All Inwood finishes are catalyzed varnish finish. Our multi-step satin finishes leave an open grain natural look to the furniture. Available in following cherry finishes: (6LC) light cherry on birch, (7MC) medium cherry on birch, (8DC) dark cherry on birch, (NB) natural birch on birch, (MB) mocha birch on birch, (CB) cherry birch on birch, (2ML) natural maple on birch, (3ML) light maple on birch, (4ML) medium maple on birch, and (5ML) cherry on birch. Twelve Durasyn textured paint finishes standard. Durasyn is a tinted painted finish with post-catalyzed varnish and acid cured topcoats formulated for superior performance on MDF. Durasyn offers superior scratch, mar, chemical and moisture resistance properties. Durasyn has been enhanced with UV absorbers to further increase UV protection.

### pulls/grommets:

Pulls are available in two styles for the Brio series furniture. The standard square pull will be put on Brio. If requested for no additional up charge, the "twisted" pull can be put on by just adding an "OP" at the end of the product code.

Standard silver grommets. Optional black available (no upcharge)

### instructions for brio product are available online and within product cartons

#### online instructions

Inwood Office Environments makes available product instructions for 2200 series Brio office furniture. Please visit [inwood.net](http://inwood.net) and click the instructions link to review the downloadable PDF documents. Any issues? Assistance is only a phone call away. Call 1-800-786-6121 or 1-812-482-6121 for Inwood customer service. Our customer service representatives can talk you through most issues. Need professional service? We would be happy to suggest an authorized dealer or service technician within your area.

#### For COM:

Sizes of Inserts/Modesty Panels

No more than 5/16" thick

Make notation of direction or pattern of grains

For 66" Desks  
30" wide 27 7/16" x 21 7/8"

For 72" Desks  
36" wide 33 7/16" x 21 7/8"

HWDOOR	14 5/16" x 38 13/16"
ODF2266	12 25/32" x 10 15/16"
ODF2272	14 9/32" x 10 15/16"
OUF2236	14 9/32" x 10 15/16"
OUF2248	12 17/64" x 10 15/16"
OUF2266	12 25/32" x 10 15/16"
OUF2272	14 9/32" x 10 15/16"
WHF2236	14 5/16" x 10 7/16"
WHF2248	12 5/16" x 10 7/16"
WHF2254	14 5/16" x 10 7/16"
WHF2266	12 13/16" x 10 7/16"
HWOF2218L	14 5/16" x 12 3/8"



---

**brio**

**desks**

letter  
side to side

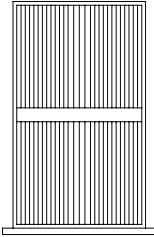

legal  
side to side

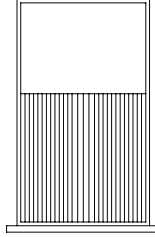

---

**returns  
and  
credenzas**

letter  
side to side

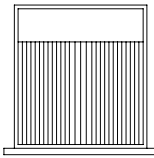

legal  
side to side

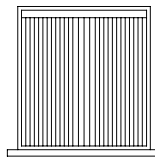

---

**lateral files**

legal  
front to back

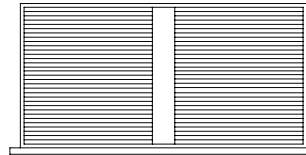
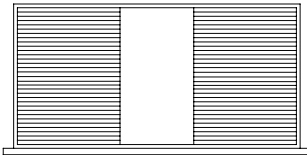

---

**modesty and overhead door insert options:**



chemcast

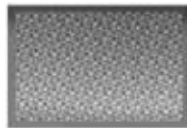

fabric



laminate

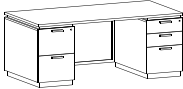
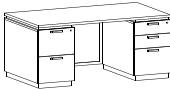

veneer

	model number	description	d	w	h	freight
	F2272 - _ - _ - _ - _	double pedestal desk left file/file pedestal right box/box/file pedestal modesty insert	36	72	29	class 125 cwt 320 lb cu ft 53
	F2266 - _ - _ - _ - _	double pedestal desk left file/file pedestal right box/box/file pedestal modesty insert	36	66	29	class 125 cwt 315 lb cu ft 48

① ② ③ ④  
**F2272-6B-W-S-C**

- ① Finish of product
- ② Wood or Laminate Top
- ③ Spacer/Base & Modesty Frame Color (all same)
- ④ Modesty Insert Option
  - F=Fabric
  - W=Wood
  - L=Laminate
  - C=Chemcast™
  - D=Durasyn

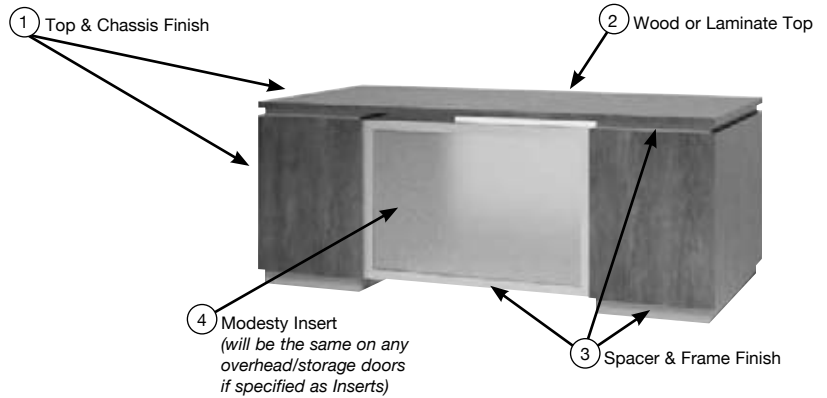

<b>top material</b>	<b>P</b> laminate top <b>W</b> veneer top	<b>wood top &amp; chassis finish</b>	<b>6LC-W</b> light cherry on birch <b>7MC-W</b> medium cherry on birch <b>8DC-W</b> dark cherry on birch <b>MB-W</b> mocha birch on birch <b>NB-W</b> natural birch on birch <b>CB-W</b> cherry birch on birch <b>2ML-W</b> natural maple on birch <b>3ML-W</b> light maple on birch <b>4ML-W</b> medium maple on birch <b>5ML-W</b> cherry maple on birch	<b>durasyn</b> modesty grade 1	<b>BP</b> black pearl <b>BL</b> black <b>CH</b> chinchilla <b>CT</b> cactus <b>EW</b> eggshell white <b>FG</b> fog <b>NB</b> natural beige <b>NG</b> northsea gray <b>PE</b> pearl <b>RK</b> rock <b>SD</b> sand <b>ST</b> sunset <b>TW</b> tumbleweed
<b>modesty option key</b>	<b>W</b> = veneer <b>L</b> = laminate <b>D</b> = durasyn <b>C.O.M.</b> <b>A</b> = acrilux <b>F</b> = fabric <b>C</b> = chemcast™	<b>laminate top finish</b>	<b>6LC-P</b> light cherry on birch <b>7MC-P</b> medium cherry on birch <b>8DC-P</b> dark cherry on birch <b>NB-P</b> natural on birch <b>MB-P</b> mocha on birch <b>CB-P</b> cherry on birch <b>2ML-P</b> natural maple on birch <b>3ML-P</b> light maple on birch <b>4ML-P</b> medium maple on birch <b>5ML-P</b> cherry maple on birch <b>EW-P</b> eggshell white (EW Durasyn on chassis)	<b>chemcast™</b> modesty grade 3	<b>2025</b> black <b>2069</b> blue <b>2247</b> white <b>2370</b> bronze <b>P-95</b> clear
<b>grade 1</b>	wood, laminate, durasyn, c.o.m.	<b>spacer &amp; frame finish</b>	<b>B</b> black <b>EW</b> eggshell white <b>S</b> silver		
<b>grade 2</b>	acrilux (5 unit minimum), fabric				
<b>grade 3</b>	chemcast™				
<b>edge</b>	<b>G</b>	<b>pulls</b>	all brio units ship standard with (square) pulls optional (twisted) pulls are available for no upcharge - specify (OP) for optional pull		



veneer top grade 1 insert		veneer top grade 2 insert		veneer top grade 3 insert		laminate top grade 1 insert		laminate top grade 2 insert		laminate top grade 3 insert	
list pricing zone 1	zone 2	list pricing zone 1	zone 2	list pricing zone 1	zone 2	list pricing zone 1	zone 2	list pricing zone 1	zone 2	list pricing zone 1	zone 2
4,238	4,578	4,327	4,673	4,514	4,875	4,079	4,405	4,168	4,501	4,354	4,702
3,603	3,891	3,699	3,995	3,904	4,216	3,413	3,685	3,508	3,789	3,751	4,051

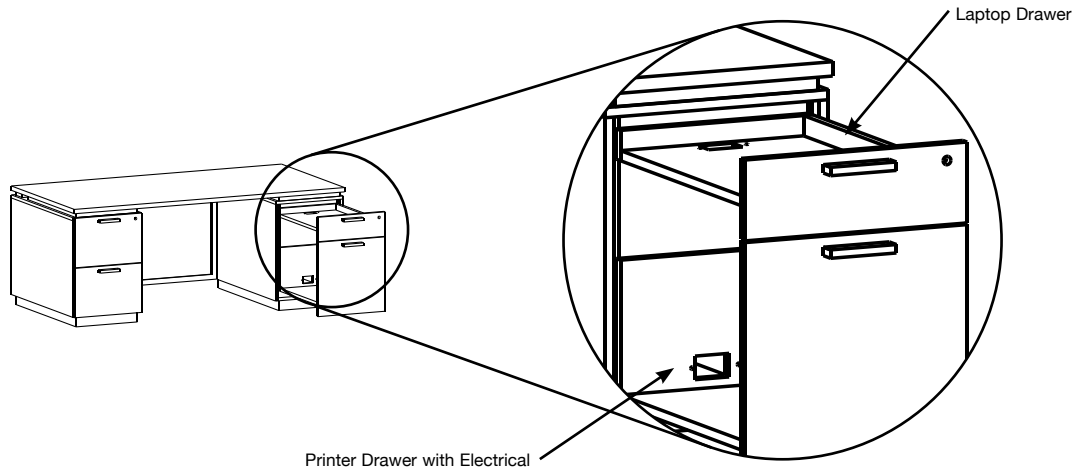

laminat	INSERTS	veneer	INSERTS	fabric	INSERTS	momentum	INSERTS
modesty grade 1	NB-P natural birch on birch CB-P cherry birch on birch 2ML-P natural maple on birch 3ML-P light maple on birch 4ML-P medium maple on birch 5ML-P cherry on maple on birch 6LC-P light cherry on birch 7MC-P medium cherry on birch 8DC-P dark cherry on birch 3L-P saddle on walnut 4L-P dark mahogany on walnut 25B-P ebony on walnut 25M-P mahogany on walnut MB-P mocha on birch BA black ashwood BB bethany beige CF copper fusion CL chili CM cardamom fiber CN cinnamon CO coriander fiber CU curacao fiber EW eggshell white GS graphite specktrum GV galvan NV negotiating in geneva NV-G negotiating in geneva gloss OS olive serenity RA rock of ages SU sugar fiber TY thyme fiber WH wheat fiber	modesty grade 1	NB-W natural birch on birch CB-W cherry birch on birch 6LC-W light cherry on birch 7MC-W medium cherry on birch 8DC-W dark cherry on birch MB-W mocha birch on birch 2ML-W natural maple on birch 3ML-W light maple on birch 4ML-W medium maple on birch 5ML-W cherry on birch 1NC-W natural cherry on cherry 2HC-W honey cherry on cherry 9BC-W burgundy cherry on cherry 88M-W mahogany on cherry 2KL-W sepia on walnut 3L-W saddle on walnut 4L-W dark mahogany on walnut 25C-W cherry on walnut 25M-W mahogany on walnut 25B-W ebony on walnut EW-W eggshell white on birch 2ML-W natural maple on birch 3ML-W light maple on birch 4ML-W medium maple on birch 5ML-W cherry maple on birch	modesty grade 2	322-001 rouge 322-009 copper 322-007 bronze 322-013 limelight 322-004 denim 322-000 taupe 323-001 rosewood 323-009 russet 323-019 amber 323-013 limelight 323-004 indigo 323-000 bronze 332-001 pomegranate 334-009 copper 334-007 moonbeam 334-013 limelight 334-004 cobalt 334-000 mocha 302-001 paprika 302-009 copper 302-002 bamboo 302-023 willow 302-014 admiral 302-000 chocolate 316-009 copper 316-019 red clay 316-008 plum 316-003 feldspar 316-024 turquoise 316-004 sapphire 316-010 taupe 316-006 smoke	momentum axis	09102740 paprika 09102773 summer 09102718 grove 09102707 denim 09102729 noir 09102751 truffie 09097955 ascot 09097966 coin 09098021 trellis 09097977 imperial 09098010 shadow 09097999 mocha 09067502 garnet 09067481 amethyst 09067497 eco 09067529 sapphire 09067518 jet 09067540 steel 09067486 bayou 09067525 myth 09067492 bottle 09067532 sodalite 09067512 iron 09067545 system

## F2272-6B-W-B-F

series - dimensions & unit identification (type) - **top/chassis finish** - **top material** - **spacer/frame finish** - **modesty**  
 modesty choice - select grade and insert description of material  
**no insert option on credenzas**

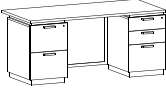
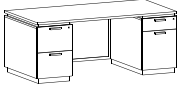
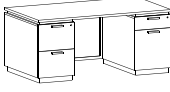
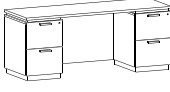
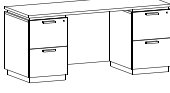
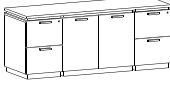
	model number	description	d	w	h	freight
	F226630 - _ - _ - _ - _	double pedestal desk left file/file pedestal right box/box/file pedestal modesty insert	30	66	29	class 125 cwt 310 lb cu ft 43
	F2272-LP - _ - _ - _ - _	double pedestal desk left file/file pedestal right laptop/printer pedestal modesty insert	36	72	29	class 125 cwt 325 lb cu ft 53
	F2266-LP - _ - _ - _ - _	double pedestal desk left file/file pedestal right laptop/printer pedestal modesty insert	36	66	29	class 125 cwt 305 lb cu ft 48
	CR2272 - _ - _ - _ - _	kneespace credenza left and right file/file pedestals veneer modesty	24	72	29	class 125 cwt 275 lb cu ft 35
	CR2266 - _ - _ - _ - _	kneespace credenza left and right file/file pedestals veneer modesty	24	66	29	class 125 cwt 270 lb cu ft 30
	CR2272-D - _ - _ - _ - _	storage credenza left and right file/file pedestals double door center adjustable shelf	24	72	29	class 125 cwt 350 lb cu ft 35

**top material**  
**P** laminate top  
**W** veneer top

**modesty option key**  
**W**= veneer  
**L**= laminate  
**D**= durasyn  
**C.O.M.**  
**A**= acrilux  
**F**= fabric  
**C**= chemcast™

**grade 1** wood, laminate,  
 durasyn, c.o.m.  
**grade 2** acrilux (5 unit minimum),  
 fabric  
**grade 3** chemcast™

**edge**

**wood top & chassis finish**

**laminate top finish**

**spacer & frame finish**

**6LC-W** light cherry on birch  
**7MC-W** medium cherry on birch  
**8DC-W** dark cherry on birch  
**MB-W** mocha birch on birch  
**NB-W** natural birch on birch  
**CB-W** cherry birch on birch  
**2ML-W** natural maple on birch  
**3ML-W** light maple on birch  
**4ML-W** medium maple on birch  
**5ML-W** cherry maple on birch

**6LC-P** light cherry on birch  
**7MC-P** medium cherry on birch  
**8DC-P** dark cherry on birch  
**NB-P** natural on birch  
**MB-P** mocha on birch  
**CB-P** cherry on birch  
**2ML-P** natural maple on birch  
**3ML-P** light maple on birch  
**4ML-P** medium maple on birch  
**5ML-P** cherry maple on birch  
**EW-P** eggshell white (EW Durasyn on chassis)

**B** black  
**EW** eggshell white  
**S** silver

**durasyn**  
 modesty  
 grade 1

**chemcast™**  
 modesty  
 grade 3

**INSERTS**  
**BP** black pearl  
**BL** black  
**CH** chinchilla  
**CT** cactus  
**EW** eggshell white  
**FG** fog  
**NB** natural beige  
**NG** northsea gray  
**PE** pearl  
**RK** rock  
**SD** sand  
**ST** sunset  
**TW** tumbleweed

**2025** black  
**2069** blue  
**2247** white  
**2370** bronze  
**P-95** clear

**pulls** all brio units ship standard with (square) pulls  
 optional (twisted) pulls are available for no  
 upcharge - specify (OP) for optional pull





veneer top grade 1 insert		veneer top grade 2 insert		veneer top grade 3 insert		laminate top grade 1 insert		laminate top grade 2 insert		laminate top grade 3 insert	
list pricing zone 1	zone 2	list pricing zone 1	zone 2	list pricing zone 1	zone 2	list pricing zone 1	zone 2	list pricing zone 1	zone 2	list pricing zone 1	zone 2
3,531	3,814	3,627	3,918	3,831	4,138	3,352	3,621	3,448	3,724	3,733	4,031
5,400	5,831	5,489	5,928	5,675	6,129	5,241	5,659	5,330	5,755	5,516	5,958
4,858	5,247	4,955	5,352	5,160	5,572	4,668	5,001	4,727	5,104	4,932	5,326
3,426	3,701					3,254	3,515				
3,323	3,588					3,151	3,403				
4,130	4,460					3,836	4,141				

laminat	INSER	veneer	INSER	fabric	INSER	moment	INSER
modesty grade 1	NB-P natural birch on birch CB-P cherry birch on birch 2ML-P natural maple on birch 3ML-P light maple on birch 4ML-P medium maple on birch 5ML-P cherry on maple on birch 6LC-P light cherry on birch 7MC-P medium cherry on birch 8DC-P dark cherry on birch 3L-P saddle on walnut 4L-P dark mahogany on walnut 25B-P ebony on walnut 25M-P mahogany on walnut MB-P mocha on birch BA black ashwood BB bethany beige CF copper fusion CL chili CM cardamom fiber CN cinnamon CO coriander fiber CU curacao fiber EW eggshell white GS graphite specktrum GV galvan NV negotiating in geneva NV-G negotiating in geneva gloss OS olive serenity RA rock of ages SU sugar fiber TY thyme fiber WH wheat fiber	modesty grade 1	NB-W natural birch on birch CB-W cherry birch on birch 6LC-W light cherry on birch 7MC-W medium cherry on birch 8DC-W dark cherry on birch MB-W mocha birch on birch 2ML-W natural maple on birch 3ML-W light maple on birch 4ML-W medium maple on birch 5ML-W cherry on birch 1NC-W natural cherry on cherry 2HC-W honey cherry on cherry 9BC-W burgundy cherry on cherry 88M-W mahogany on cherry 2KL-W sepia on walnut 3L-W saddle on walnut 4L-W dark mahogany on walnut 25C-W cherry on walnut 25M-W mahogany on walnut 25B-W ebony on walnut EW-W eggshell white on birch 2ML-W natural maple on birch 3ML-W light maple on birch 4ML-W medium maple on birch 5ML-W cherry maple on birch	modesty grade 2 mayer catalyst mayer equation mayer lunar mayer paramount mayer element	322-001 rouge 322-009 copper 322-007 bronze 322-013 limelight 322-004 denim 322-000 taupe 323-001 rosewood 323-009 russet 323-019 amber 323-013 limelight 323-004 indigo 323-000 bronze 332-001 pomegranate 334-009 copper 334-007 moonbeam 334-013 limelight 334-004 cobalt 334-000 mocha 302-001 paprika 302-009 copper 302-002 bamboo 302-023 willow 302-014 admiral 302-000 chocolate 316-009 copper 316-019 red clay 316-008 plum 316-003 feldspar 316-024 turquoise 316-004 sapphire 316-010 taupe 316-006 smoke	momentum axis momentum russo momentum origin	09102740 paprika 09102773 summer 09102718 grove 09102707 denim 09102729 noir 09102751 truffie 09097955 ascot 09097966 coin 09098021 trellis 09097977 imperial 09098010 shadow 09097999 mocha 09067502 garnet 09067481 amethyst 09067497 eco 09067529 sapphire 09067518 jet 09067540 steel 09067486 bayou 09067525 myth 09067492 bottle 09067532 sodalite 09067512 iron 09067545 system



## F2272-6B-W-B-F

series - dimensions & unit identification (type) - **top/chassis finish** - **top material** - **spacer/frame finish** - **modesty**  
 modesty choice - select grade and insert description of material  
**no insert option on credenzas**

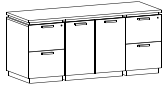
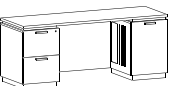
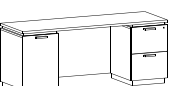
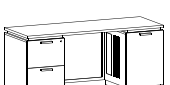
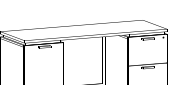
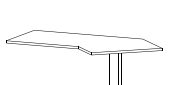
	model number	description	d	w	h	freight
	CR2266-D - _ - _ - _	storage credenza left and right file/file pedestals double door center adjustable shelf	24	66	29	class 125 cwt 350 lb cu ft 35
	CR2272R-C - _ - _ - _	kneespace credenza left file/file pedestal right CPU pedestal vener modesty	24	72	29	class 125 cwt 275 lb cu ft 35
	CR2272L-C - _ - _ - _	kneespace credenza right file/file pedestal left CPU pedestal vener modesty	24	72	29	class 125 cwt 275 lb cu ft 35
	CR2266R-C - _ - _ - _	double pedestal credenza right CPU pedestal left file/file pedestal	24	66	29	class 125 cwt 270 lb cu ft 30
	CR2266L-C - _ - _ - _	double pedestal credenza left CPU pedestal right file/file pedestal	24	66	29	class 125 cwt 270 lb cu ft 30
	EM2272R - _ - _ - _	extension top with PLB (wood base) for attachment to another unit	30-42	72	29	class 125 cwt 105 lb cu ft 14

**top material**  
**P** laminate top  
**W** veneer top

**modesty option key**  
**W**= veneer  
**L**= laminate  
**D**= durasyn  
**C.O.M.**  
**A**= acrilux  
**F**= fabric  
**C**= chemcast™

**grade 1** wood, laminate,  
 durasyn, c.o.m.  
**grade 2** acrilux (5 unit minimum),  
 fabric  
**grade 3** chemcast™

**edge**

**wood top & chassis finish**

**laminate top finish**

**spacer & frame finish**

**6LC-W** light cherry on birch  
**7MC-W** medium cherry on birch  
**8DC-W** dark cherry on birch  
**MB-W** mocha birch on birch  
**NB-W** natural birch on birch  
**CB-W** cherry birch on birch  
**2ML-W** natural maple on birch  
**3ML-W** light maple on birch  
**4ML-W** medium maple on birch  
**5ML-W** cherry maple on birch

**6LC-P** light cherry on birch  
**7MC-P** medium cherry on birch  
**8DC-P** dark cherry on birch  
**NB-P** natural on birch  
**MB-P** mocha on birch  
**CB-P** cherry on birch  
**2ML-P** natural maple on birch  
**3ML-P** light maple on birch  
**4ML-P** medium maple on birch  
**5ML-P** cherry maple on birch  
**EW-P** eggshell white (EW Durasyn on chassis)

**B** black  
**EW** eggshell white  
**S** silver

**durasyn**  
 modesty grade 1

**chemcast™**  
 modesty grade 3

**INSERTS**  
**BP** black pearl  
**BL** black  
**CH** chinchilla  
**CT** cactus  
**EW** eggshell white  
**FG** fog  
**NB** natural beige  
**NG** northsea gray  
**PE** pearl  
**RK** rock  
**SD** sand  
**ST** sunset  
**TW** tumbleweed

**2025** black  
**2069** blue  
**2247** white  
**2370** bronze  
**P-95** clear

**pulls** all brio units ship standard with (square) pulls  
 optional (twisted) pulls are available for no  
 upcharge - specify (OP) for optional pull



brío

| 2200 series

| wood top, veneer chassis, veneer drawer fronts

| laminate top, veneer chassis, veneer drawer fronts



veneer top grade 1 insert		veneer top grade 2 insert		veneer top grade 3 insert		laminate top grade 1 insert		laminate top grade 2 insert		laminate top grade 3 insert	
list pricing zone 1	zone 2	list pricing zone 1	zone 2	list pricing zone 1	zone 2	list pricing zone 1	zone 2	list pricing zone 1	zone 2	list pricing zone 1	zone 2
3,955	4,271					3,778	4,081				
2,555	2,760					2,383	2,573				
2,555	2,760					2,383	2,573				
2,492	2,690					2,319	2,504				
2,492	2,690					2,319	2,504				
1,647	1,780					1,416	1,530				

laminat	INSERTS	veneer	INSERTS	fabric	INSERTS	momentum	INSERTS	
modesty grade 1	NB-P natural birch on birch CB-P cherry birch on birch 2ML-P natural maple on birch 3ML-P light maple on birch 4ML-P medium maple on birch 5ML-P cherry on maple on birch 6LC-P light cherry on birch 7MC-P medium cherry on birch 8DC-P dark cherry on birch 3L-P saddle on walnut 4L-P dark mahogany on walnut 25B-P ebony on walnut 25M-P mahogany on walnut MB-P mocha on birch BA black ashwood BB bethany beige CF copper fusion CL chili CM cardamom fiber CN cinnamon CO coriander fiber CU curacao fiber EW eggshell white GS graphite specktrum GV galvan NV negotiating in geneva NV-G negotiating in geneva gloss OS olive serenity RA rock of ages SU sugar fiber TY thyme fiber WH wheat fiber	modesty grade 1	NB-W natural birch on birch CB-W cherry birch on birch 6LC-W light cherry on birch 7MC-W medium cherry on birch 8DC-W dark cherry on birch MB-W mocha birch on birch 2ML-W natural maple on birch 3ML-W light maple on birch 4ML-W medium maple on birch 5ML-W cherry on birch 1NC-W natural cherry on cherry 2HC-W honey cherry on cherry 9BC-W burgundy cherry on cherry 88M-W mahogany on cherry 2KL-W sepia on walnut 3L-W saddle on walnut 4L-W dark mahogany on walnut 25C-W cherry on walnut 25M-W mahogany on walnut 25B-W ebony on walnut EW-W eggshell white on birch 2ML-W natural maple on birch 3ML-W light maple on birch 4ML-W medium maple on birch 5ML-W cherry maple on birch	modesty grade 2	322-001 rouge 322-009 copper 322-007 bronze 322-013 limelight 322-004 denim 322-000 taupe 323-001 rosewood 323-009 russet 323-019 amber 323-013 limelight 323-004 indigo 323-000 bronze 332-001 pomegranate 334-009 copper 334-007 moonbeam 334-013 limelight 334-004 cobalt 334-000 mocha 302-001 paprika 302-009 copper 302-002 bamboo 302-023 willow 302-014 admiral 302-000 chocolate 316-009 copper 316-019 red clay 316-008 plum 316-003 feldspar 316-024 turquoise 316-004 sapphire 316-010 taupe 316-006 smoke	mayer catalyst mayer equation mayer lunar mayer paramount mayer element	axis russo origin	09102740 paprika 09102773 summer 09102718 grove 09102707 denim 09102729 noir 09102751 truffie 09097955 ascot 09097966 coin 09098021 trellis 09097977 imperial 09098010 shadow 09097999 mocha 09067502 garnet 09067481 amethyst 09067497 eco 09067529 sapphire 09067518 jet 09067540 steel 09067486 bayou 09067525 myth 09067492 bottle 09067532 sodalite 09067512 iron 09067545 system

## F2272-6B-W-B-F

series - dimensions & unit identification (type) - top/chassis finish - top material - spacer/frame finish - modesty  
modesty choice - select grade and insert description of material

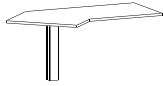
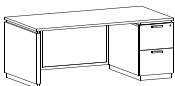
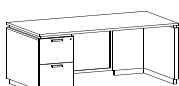
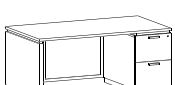
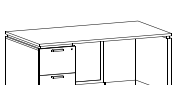
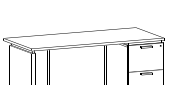
	model number	description	d	w	h	freight
	EM2272L - _ - _ - _ -	extension top with PLB (wood base) for attachment to another unit	30-42	72	29	class 125 cwt 105 lb cu ft 14
	D2272R - _ - _ - _ -	single pedestal desk right file/file pedestal modesty insert	36	72	29	class 125 cwt 253 lb cu ft 4
	D2272L - _ - _ - _ -	single pedestal desk left file/file pedestal modesty insert	36	72	29	class 125 cwt 253 lb cu ft 4
	D2266R - _ - _ - _ -	single pedestal desk right file/file pedestal modesty insert	36	66	29	class 125 cwt 260 lb cu ft 48
	D2266L - _ - _ - _ -	single pedestal desk left file/file pedestal modesty insert	36	66	29	class 125 cwt 260 lb cu ft 48
	D226630R - _ - _ - _ -	single pedestal desk right file/file pedestal modesty insert	30	66	29	class 125 cwt 250 lb cu ft 45

**top material**  
P laminate top  
W veneer top

**modesty option key**  
W= veneer  
L= laminate  
D= durasyn  
C.O.M.  
A= acrilux  
F= fabric  
C= chemcast™

**grade 1** wood, laminate,  
durasyn, c.o.m.  
**grade 2** acrilux (5 unit minimum),  
fabric  
**grade 3** chemcast™

**edge**

**wood top & chassis finish**

**laminate top finish**

**spacer & frame finish**

**6LC-W** light cherry on birch  
**7MC-W** medium cherry on birch  
**8DC-W** dark cherry on birch  
**MB-W** mocha birch on birch  
**NB-W** natural birch on birch  
**CB-W** cherry birch on birch  
**2ML-W** natural maple on birch  
**3ML-W** light maple on birch  
**4ML-W** medium maple on birch  
**5ML-W** cherry maple on birch

**6LC-P** light cherry on birch  
**7MC-P** medium cherry on birch  
**8DC-P** dark cherry on birch  
**NB-P** natural on birch  
**MB-P** mocha on birch  
**CB-P** cherry on birch  
**2ML-P** natural maple on birch  
**3ML-P** light maple on birch  
**4ML-P** medium maple on birch  
**5ML-P** cherry maple on birch  
**EW-P** eggshell white (EW Durasyn on chassis)

**B** black  
**EW** eggshell white  
**S** silver

**durasyn**  
modesty  
grade 1

**chemcast™**  
modesty  
grade 3

**INSERTS**  
**BP** black pearl  
**BL** black  
**CH** chinchilla  
**CT** cactus  
**EW** eggshell white  
**FG** fog  
**NB** natural beige  
**NG** northsea gray  
**PE** pearl  
**RK** rock  
**SD** sand  
**ST** sunset  
**TW** tumbleweed

**2025** black  
**2069** blue  
**2247** white  
**2370** bronze  
**P-95** clear

**pulls** all brio units ship standard with (square) pulls  
optional (twisted) pulls are available for no  
upcharge - specify (OP) for optional pull

G



veneer top grade 1 insert		veneer top grade 2 insert		veneer top grade 3 insert		laminate top grade 1 insert		laminate top grade 2 insert		laminate top grade 3 insert	
list pricing zone 1	zone 2	list pricing zone 1	zone 2	list pricing zone 1	zone 2	list pricing zone 1	zone 2	list pricing zone 1	zone 2	list pricing zone 1	zone 2
1,647	1,780					1,416	1,530				
2,986	3,225	3,081	3,327	3,286	3,549	2,754	2,975	2,850	3,078	3,055	3,299
2,986	3,225	3,081	3,327	3,286	3,549	2,754	2,975	2,850	3,078	3,055	3,299
2,892	3,123	2,985	3,223	3,189	3,445	2,698	2,914	2,793	3,017	3,036	3,279
2,892	3,123	2,985	3,223	3,189	3,445	2,698	2,914	2,793	3,017	3,036	3,279
2,820	3,046	2,913	3,147	3,118	3,367	2,637	2,848	2,734	2,952	3,018	3,260

laminat	INSERTS	veneer	INSERTS	fabric	INSERTS	momentum	INSERTS
modesty grade 1	<b>NB-P</b> natural birch on birch <b>CB-P</b> cherry birch on birch <b>2ML-P</b> natural maple on birch <b>3ML-P</b> light maple on birch <b>4ML-P</b> medium maple on birch <b>5ML-P</b> cherry on maple on birch <b>6LC-P</b> light cherry on birch <b>7MC-P</b> medium cherry on birch <b>8DC-P</b> dark cherry on birch <b>3L-P</b> saddle on walnut <b>4L-P</b> dark mahogany on walnut <b>25B-P</b> ebony on walnut <b>25M-P</b> mahogany on walnut <b>MB-P</b> mocha on birch <b>BA</b> black ashwood <b>BB</b> bethany beige <b>CF</b> copper fusion <b>CL</b> chili <b>CM</b> cardamom fiber <b>CN</b> cinnamon <b>CO</b> coriander fiber <b>CU</b> curacao fiber <b>EW</b> eggshell white <b>GS</b> graphite specktrum <b>GV</b> galvan <b>NV</b> negotiating in geneva <b>NV-G</b> negotiating in geneva gloss <b>OS</b> olive serenity <b>RA</b> rock of ages <b>SU</b> sugar fiber <b>TY</b> thyme fiber <b>WH</b> wheat fiber	<b>NB-W</b> natural birch on birch <b>CB-W</b> cherry birch on birch <b>6LC-W</b> light cherry on birch <b>7MC-W</b> medium cherry on birch <b>8DC-W</b> dark cherry on birch <b>MB-W</b> mocha birch on birch <b>2ML-W</b> natural maple on birch <b>3ML-W</b> light maple on birch <b>4ML-W</b> medium maple on birch <b>5ML-W</b> cherry on birch <b>1NC-W</b> natural cherry on cherry <b>2HC-W</b> honey cherry on cherry <b>9BC-W</b> burgundy cherry on cherry <b>88M-W</b> mahogany on cherry <b>2KL-W</b> sepia on walnut <b>3L-W</b> saddle on walnut <b>4L-W</b> dark mahogany on walnut <b>25C-W</b> cherry on walnut <b>25M-W</b> mahogany on walnut <b>25B-W</b> ebony on walnut <b>EW-W</b> eggshell white on birch <b>2ML-W</b> natural maple on birch <b>3ML-W</b> light maple on birch <b>4ML-W</b> medium maple on birch <b>5ML-W</b> cherry maple on birch	<b>modesty grade 2</b> mayer catalyst mayer equation mayer lunar mayer paramount mayer element	<b>322-001</b> rouge <b>322-009</b> copper <b>322-007</b> bronze <b>322-013</b> limelight <b>322-004</b> denim <b>322-000</b> taupe <b>323-001</b> rosewood <b>323-009</b> russet <b>323-019</b> amber <b>323-013</b> limelight <b>323-004</b> indigo <b>323-000</b> bronze <b>332-001</b> pomegranate <b>334-009</b> copper <b>334-007</b> moonbeam <b>334-013</b> limelight <b>334-004</b> cobalt <b>334-000</b> mocha <b>302-001</b> paprika <b>302-009</b> copper <b>302-002</b> bamboo <b>302-023</b> willow <b>302-014</b> admiral <b>302-000</b> chocolate <b>316-009</b> copper <b>316-019</b> red clay <b>316-008</b> plum <b>316-003</b> feldspar <b>316-024</b> turquoise <b>316-004</b> sapphire <b>316-010</b> taupe <b>316-006</b> smoke	<b>axis</b> <b>russo</b> <b>origin</b>	<b>09102740</b> paprika <b>09102773</b> summer <b>09102718</b> grove <b>09102707</b> denim <b>09102729</b> noir <b>09102751</b> truffie <b>09097955</b> ascot <b>09097966</b> coin <b>09098021</b> trellis <b>09097977</b> imperial <b>09098010</b> shadow <b>09097999</b> mocha <b>09067502</b> garnet <b>09067481</b> amethyst <b>09067497</b> eco <b>09067529</b> sapphire <b>09067518</b> jet <b>09067540</b> steel <b>09067486</b> bayou <b>09067525</b> myth <b>09067492</b> bottle <b>09067532</b> sodalite <b>09067512</b> iron <b>09067545</b> system	

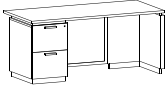
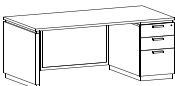
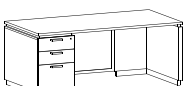
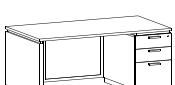
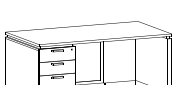
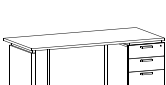
	model number	description	d	w	h	freight
	D226630L - _ _ _ _ _	single pedestal desk left file/file pedestal modesty insert	30	66	29	class 125 cwt 250 lb cu ft 45
	D2272R-3D - _ _ _ _ _	single pedestal desk right box/box/file pedestal modesty insert	36	72	29	class 125 cwt 270 lb cu ft 53
	D2272L-3D - _ _ _ _ _	single pedestal desk left box/box/file pedestal modesty insert	36	72	29	class 125 cwt 270 lb cu ft 53
	D2266R-3D - _ _ _ _ _	single pedestal desk right box/box/file pedestal modesty insert	36	66	29	class 125 cwt 260 lb cu ft 48
	D2266L-3D - _ _ _ _ _	single pedestal desk left box/box/file pedestal modesty insert	36	66	29	class 125 cwt 260 lb cu ft 48
	D226030R-3D - _ _ _ _ _	single pedestal desk right box/box/file pedestal modesty insert	30	60	29	class 125 cwt 250 lb cu ft 45

**top material**

**P** laminate top  
**W** veneer top

**modesty option key**

**W**= veneer  
**L**= laminate  
**D**= durasyn  
**C.O.M.**  
**A**= acrilux  
**F**= fabric  
**C**= chemcast™

**grade 1**

wood, laminate,  
durasyn, c.o.m.

**grade 2**

acrilux (5 unit minimum),  
fabric

**grade 3**

chemcast™

**edge**



**wood top & chassis finish**

**6LC-W** light cherry on birch  
**7MC-W** medium cherry on birch  
**8DC-W** dark cherry on birch  
**MB-W** mocha birch on birch  
**NB-W** natural birch on birch  
**CB-W** cherry birch on birch  
**2ML-W** natural maple on birch  
**3ML-W** light maple on birch  
**4ML-W** medium maple on birch  
**5ML-W** cherry maple on birch

**laminate top finish**

**6LC-P** light cherry on birch  
**7MC-P** medium cherry on birch  
**8DC-P** dark cherry on birch  
**NB-P** natural on birch  
**MB-P** mocha on birch  
**CB-P** cherry on birch  
**2ML-P** natural maple on birch  
**3ML-P** light maple on birch  
**4ML-P** medium maple on birch  
**5ML-P** cherry maple on birch  
**EW-P** eggshell white (EW Durasyn on chassis)

**spacer & frame finish**

**B** black  
**EW** eggshell white  
**S** silver

**durasyn**

modesty  
grade 1

**chemcast™**

modesty  
grade 3

**INSERTS**

**BP** black pearl  
**BL** black  
**CH** chinchilla  
**CT** cactus  
**EW** eggshell white  
**FG** fog  
**NB** natural beige  
**NG** northsea gray  
**PE** pearl  
**RK** rock  
**SD** sand  
**ST** sunset  
**TW** tumbleweed

**2025** black  
**2069** blue  
**2247** white  
**2370** bronze  
**P-95** clear

**pulls**

all brio units ship standard with (square) pulls  
optional (twisted) pulls are available for no  
upcharge - specify (OP) for optional pull





veneer top grade 1 insert		veneer top grade 2 insert		veneer top grade 3 insert		laminate top grade 1 insert		laminate top grade 2 insert		laminate top grade 3 insert	
list pricing zone 1	zone 2	list pricing zone 1	zone 2	list pricing zone 1	zone 2	list pricing zone 1	zone 2	list pricing zone 1	zone 2	list pricing zone 1	zone 2
2,820	3,046	2,913	3,147	3,118	3,367	2,637	2,848	2,734	2,952	3,018	3,260
3,237	3,497	3,333	3,600	3,537	3,821	3,006	3,247	3,102	3,351	3,307	3,572
3,237	3,497	3,333	3,600	3,537	3,821	3,006	3,247	3,102	3,351	3,307	3,572
3,145	3,396	3,236	3,496	3,441	3,716	2,950	3,185	3,046	3,290	3,288	3,552
3,145	3,396	3,236	3,496	3,441	3,716	2,950	3,185	3,046	3,290	3,288	3,552
3,072	3,318	3,164	3,418	3,369	3,638	2,890	3,121	2,986	3,225	3,270	3,531

laminat	INSERTS	veneer	INSERTS	fabric	INSERTS	momentum	INSERTS
modesty grade 1	<b>NB-P</b> natural birch on birch <b>CB-P</b> cherry birch on birch <b>2ML-P</b> natural maple on birch <b>3ML-P</b> light maple on birch <b>4ML-P</b> medium maple on birch <b>5ML-P</b> cherry on maple on birch <b>6LC-P</b> light cherry on birch <b>7MC-P</b> medium cherry on birch <b>8DC-P</b> dark cherry on birch <b>3L-P</b> saddle on walnut <b>4L-P</b> dark mahogany on walnut <b>25B-P</b> ebony on walnut <b>25M-P</b> mahogany on walnut <b>MB-P</b> mocha on birch <b>BA</b> black ashwood <b>BB</b> bethany beige <b>CF</b> copper fusion <b>CL</b> chili <b>CM</b> cardamom fiber <b>CN</b> cinnamon <b>CO</b> coriander fiber <b>CU</b> curacao fiber <b>EW</b> eggshell white <b>GS</b> graphite specktrum <b>GV</b> galvan <b>NV</b> negotiating in geneva <b>NV-G</b> negotiating in geneva gloss <b>OS</b> olive serenity <b>RA</b> rock of ages <b>SU</b> sugar fiber <b>TY</b> thyme fiber <b>WH</b> wheat fiber	modesty grade 1	<b>NB-W</b> natural birch on birch <b>CB-W</b> cherry birch on birch <b>6LC-W</b> light cherry on birch <b>7MC-W</b> medium cherry on birch <b>8DC-W</b> dark cherry on birch <b>MB-W</b> mocha birch on birch <b>2ML-W</b> natural maple on birch <b>3ML-W</b> light maple on birch <b>4ML-W</b> medium maple on birch <b>5ML-W</b> cherry on birch <b>1NC-W</b> natural cherry on cherry <b>2HC-W</b> honey cherry on cherry <b>9BC-W</b> burgundy cherry on cherry <b>88M-W</b> mahogany on cherry <b>2KL-W</b> sepia on walnut <b>3L-W</b> saddle on walnut <b>4L-W</b> dark mahogany on walnut <b>25C-W</b> cherry on walnut <b>25M-W</b> mahogany on walnut <b>25B-W</b> ebony on walnut <b>EW-W</b> eggshell white on birch <b>2ML-W</b> natural maple on birch <b>3ML-W</b> light maple on birch <b>4ML-W</b> medium maple on birch <b>5ML-W</b> cherry maple on birch	<b>322-001</b> rouge <b>322-009</b> copper <b>322-007</b> bronze <b>322-013</b> limelight <b>322-004</b> denim <b>322-000</b> taupe  <b>323-001</b> rosewood <b>323-009</b> russet <b>323-019</b> amber <b>323-013</b> limelight <b>323-004</b> indigo <b>323-000</b> bronze  <b>332-001</b> pomegranate <b>334-009</b> copper <b>334-007</b> moonbeam <b>334-013</b> limelight <b>334-004</b> cobalt <b>334-000</b> mocha  <b>302-001</b> paprika <b>302-009</b> copper <b>302-002</b> bamboo <b>302-023</b> willow <b>302-014</b> admiral <b>302-000</b> chocolate  <b>316-009</b> copper <b>316-019</b> red clay <b>316-008</b> plum <b>316-003</b> feldspar <b>316-024</b> turquoise <b>316-004</b> sapphire <b>316-010</b> taupe <b>316-006</b> smoke	axis  russo  origin	<b>09102740</b> paprika <b>09102773</b> summer <b>09102718</b> grove <b>09102707</b> denim <b>09102729</b> noir <b>09102751</b> truffie  <b>09097955</b> ascot <b>09097966</b> coin <b>09098021</b> trellis <b>09097977</b> imperial <b>09098010</b> shadow <b>09097999</b> mocha  <b>09067502</b> garnet <b>09067481</b> amethyst <b>09067497</b> eco <b>09067529</b> sapphire <b>09067518</b> jet <b>09067540</b> steel <b>09067486</b> bayou <b>09067525</b> myth <b>09067492</b> bottle <b>09067532</b> sodalite <b>09067512</b> iron <b>09067545</b> system	

## F2272-6B-W-B-F

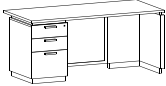
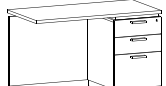
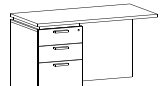
series - dimensions & unit identification (type) - **top/chassis finish** - **top material** - **spacer/frame finish** - **modesty**  
 modesty choice - select grade and insert description of material  
**no insert options on bridge or credenza**

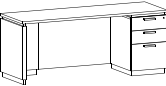
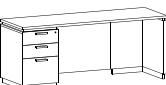
	model number	description	d	w	h	freight
	D226030L-3D - _ _ - _ - _ - _	single pedestal desk left box/box/file pedestal modesty insert	30	60	29	class 125 cwt 250 lb cu ft 45
	R2248R - _ _ - _ - _ - _	single pedestal return right box/box/file pedestal veneer modesty	24	48	29	class 125 cwt 160 lb cu ft 22
	R2248L - _ _ - _ - _ - _	single pedestal return left box/box/file pedestal veneer modesty	24	48	29	class 125 cwt 160 lb cu ft 22
	B2248 - _ _ - _ - _ - _	bridge open kneespace veneer modesty panel	24	48	29	class 125 cwt 105 lb cu ft 22
	C2272R - _ _ - _ - _ - _	single pedestal credenza right box/box/file pedestal veneer modesty	24	72	29	class 125 cwt 175 lb cu ft 35
	C2272L - _ _ - _ - _ - _	single pedestal credenza left box/box/file pedestal veneer modesty	24	72	29	class 125 cwt 175 lb cu ft 35

**top material**  
**P** laminate top  
**W** veneer top

**modesty option key**  
**W**= veneer  
**L**= laminate  
**D**= durasyn  
**C.O.M.**  
**A**= acrilux  
**F**= fabric  
**C**= chemcast™

**grade 1** wood, laminate,  
 durasyn, c.o.m.  
**grade 2** acrilux (5 unit minimum),  
 fabric  
**grade 3** chemcast™

**edge**

**wood top & chassis finish**

**laminate top finish**

**spacer & frame finish**

**6LC-W** light cherry on birch  
**7MC-W** medium cherry on birch  
**8DC-W** dark cherry on birch  
**MB-W** mocha birch on birch  
**NB-W** natural birch on birch  
**CB-W** cherry birch on birch  
**2ML-W** natural maple on birch  
**3ML-W** light maple on birch  
**4ML-W** medium maple on birch  
**5ML-W** cherry maple on birch

**6LC-P** light cherry on birch  
**7MC-P** medium cherry on birch  
**8DC-P** dark cherry on birch  
**NB-P** natural on birch  
**MB-P** mocha on birch  
**CB-P** cherry on birch  
**2ML-P** natural maple on birch  
**3ML-P** light maple on birch  
**4ML-P** medium maple on birch  
**5ML-P** cherry maple on birch  
**EW-P** eggshell white (EW Durasyn on chassis)

**B** black  
**EW** eggshell white  
**S** silver

**durasyn**  
 modesty grade 1

**chemcast™**  
 modesty grade 3

**INSERTS**  
**BP** black pearl  
**BL** black  
**CH** chinchilla  
**CT** cactus  
**EW** eggshell white  
**FG** fog  
**NB** natural beige  
**NG** northsea gray  
**PE** pearl  
**RK** rock  
**SD** sand  
**ST** sunset  
**TW** tumbleweed

**2025** black  
**2069** blue  
**2247** white  
**2370** bronze  
**P-95** clear

**pulls** all brio units ship standard with (square) pulls  
 optional (twisted) pulls are available for no  
 upcharge - specify (OP) for optional pull



brío

| 2200 series

| wood top, veneer chassis, veneer drawer fronts

| laminate top, veneer chassis, veneer drawer fronts



veneer top grade 1 insert		veneer top grade 2 insert		veneer top grade 3 insert		laminate top grade 1 insert		laminate top grade 2 insert		laminate top grade 3 insert	
list pricing zone 1	zone 2	list pricing zone 1	zone 2	list pricing zone 1	zone 2	list pricing zone 1	zone 2	list pricing zone 1	zone 2	list pricing zone 1	zone 2
3,072	3,318	3,164	3,418	3,369	3,638	2,890	3,121	2,986	3,225	3,270	3,531
1,718	1,854					1,556	1,680				
1,718	1,854					1,556	1,680				
1,012	1,092					850	918				
2,747	2,966					2,573	2,780				
2,747	2,966					2,573	2,780				

laminat	INSERTS	veneer	INSERTS	fabric	INSERTS	momentum	INSERTS
modesty grade 1	<b>NB-P</b> natural birch on birch <b>CB-P</b> cherry birch on birch <b>2ML-P</b> natural maple on birch <b>3ML-P</b> light maple on birch <b>4ML-P</b> medium maple on birch <b>5ML-P</b> cherry on maple on birch <b>6LC-P</b> light cherry on birch <b>7MC-P</b> medium cherry on birch <b>8DC-P</b> dark cherry on birch <b>3L-P</b> saddle on walnut <b>4L-P</b> dark mahogany on walnut <b>25B-P</b> ebony on walnut <b>25M-P</b> mahogany on walnut <b>MB-P</b> mocha on birch <b>BA</b> black ashwood <b>BB</b> bethany beige <b>CF</b> copper fusion <b>CL</b> chili <b>CM</b> cardamom fiber <b>CN</b> cinnamon <b>CO</b> coriander fiber <b>CU</b> curacao fiber <b>EW</b> eggshell white <b>GS</b> graphite specktrum <b>GV</b> galvan <b>NV</b> negotiating in geneva <b>NV-G</b> negotiating in geneva gloss <b>OS</b> olive serenity <b>RA</b> rock of ages <b>SU</b> sugar fiber <b>TY</b> thyme fiber <b>WH</b> wheat fiber	<b>NB-W</b> natural birch on birch <b>CB-W</b> cherry birch on birch <b>6LC-W</b> light cherry on birch <b>7MC-W</b> medium cherry on birch <b>8DC-W</b> dark cherry on birch <b>MB-W</b> mocha birch on birch <b>2ML-W</b> natural maple on birch <b>3ML-W</b> light maple on birch <b>4ML-W</b> medium maple on birch <b>5ML-W</b> cherry on birch <b>1NC-W</b> natural cherry on cherry <b>2HC-W</b> honey cherry on cherry <b>9BC-W</b> burgundy cherry on cherry <b>88M-W</b> mahogany on cherry <b>2KL-W</b> sepia on walnut <b>3L-W</b> saddle on walnut <b>4L-W</b> dark mahogany on walnut <b>25C-W</b> cherry on walnut <b>25M-W</b> mahogany on walnut <b>25B-W</b> ebony on walnut <b>EW-W</b> eggshell white on birch <b>2ML-W</b> natural maple on birch <b>3ML-W</b> light maple on birch <b>4ML-W</b> medium maple on birch <b>5ML-W</b> cherry maple on birch	<b>modesty</b> grade 2 <b>mayer</b> catalyst <b>mayer</b> equation <b>mayer</b> lunar <b>mayer</b> paramount <b>mayer</b> element	<b>322-001</b> rouge <b>322-009</b> copper <b>322-007</b> bronze <b>322-013</b> limelight <b>322-004</b> denim <b>322-000</b> taupe <b>323-001</b> rosewood <b>323-009</b> russet <b>323-019</b> amber <b>323-013</b> limelight <b>323-004</b> indigo <b>323-000</b> bronze <b>332-001</b> pomegranate <b>334-009</b> copper <b>334-007</b> moonbeam <b>334-013</b> limelight <b>334-004</b> cobalt <b>334-000</b> mocha <b>302-001</b> paprika <b>302-009</b> copper <b>302-002</b> bamboo <b>302-023</b> willow <b>302-014</b> admiral <b>302-000</b> chocolate <b>316-009</b> copper <b>316-019</b> red clay <b>316-008</b> plum <b>316-003</b> feldspar <b>316-024</b> turquoise <b>316-004</b> sapphire <b>316-010</b> taupe <b>316-006</b> smoke	<b>axis</b> <b>momentum</b> russo <b>momentum</b> origin	<b>09102740</b> paprika <b>09102773</b> summer <b>09102718</b> grove <b>09102707</b> denim <b>09102729</b> noir <b>09102751</b> truffie <b>09097955</b> ascot <b>09097966</b> coin <b>09098021</b> trellis <b>09097977</b> imperial <b>09098010</b> shadow <b>09097999</b> mocha <b>09067502</b> garnet <b>09067481</b> amethyst <b>09067497</b> eco <b>09067529</b> sapphire <b>09067518</b> jet <b>09067540</b> steel <b>09067486</b> bayou <b>09067525</b> myth <b>09067492</b> bottle <b>09067532</b> sodalite <b>09067512</b> iron <b>09067545</b> system	

brío  
2200



## F2272-6B-W-B-F

series - dimensions & unit identification (type) - top/chassis finish - top material - spacer/frame finish - modesty  
modesty choice - select grade and insert description of material  
no insert option on credenzas

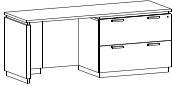
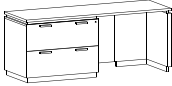
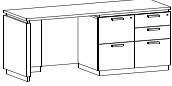
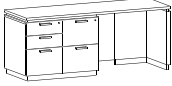
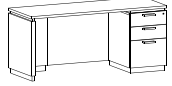
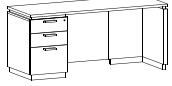
	model number	description	d	w	h	freight
	C2272R-2F - _ - _ - _	single pedestal credenza right lateral file pedestal veneer modesty	24	72	29	class 125 cwt 235 lb cu ft 35
	C2272L-2F - _ - _ - _	single pedestal credenza left lateral file pedestal veneer modesty	24	72	29	class 125 cwt 235 lb cu ft 35
	C2272R-5D - _ - _ - _	single pedestal credenza right multi-file pedestal veneer modesty	24	72	29	class 125 cwt 295 lb cu ft 28
	C2272L-5D - _ - _ - _	single pedestal credenza left multi-file pedestal veneer modesty	24	72	29	class 125 cwt 295 lb cu ft 28
	C2266R - _ - _ - _	single pedestal credenza right box/box/file pedestal veneer modesty	24	66	29	class 125 cwt 175 lb cu ft 48
	C2266L - _ - _ - _	single pedestal credenza left box/box/file pedestal veneer modesty	24	66	29	class 125 cwt 175 lb cu ft 48

**top material**  
P laminate top  
W veneer top

**modesty option key**  
W= veneer  
L= laminate  
D= durasyn  
C.O.M.  
A= acrilux  
F= fabric  
C= chemcast™

**grade 1** wood, laminate,  
durasyn, c.o.m.  
**grade 2** acrilux (5 unit minimum),  
fabric  
**grade 3** chemcast™

**edge**

G

**wood top & chassis finish**

**laminate top finish**

**spacer & frame finish**

**6LC-W** light cherry on birch  
**7MC-W** medium cherry on birch  
**8DC-W** dark cherry on birch  
**MB-W** mocha birch on birch  
**NB-W** natural birch on birch  
**CB-W** cherry birch on birch  
**2ML-W** natural maple on birch  
**3ML-W** light maple on birch  
**4ML-W** medium maple on birch  
**5ML-W** cherry maple on birch

**6LC-P** light cherry on birch  
**7MC-P** medium cherry on birch  
**8DC-P** dark cherry on birch  
**NB-P** natural on birch  
**MB-P** mocha on birch  
**CB-P** cherry on birch  
**2ML-P** natural maple on birch  
**3ML-P** light maple on birch  
**4ML-P** medium maple on birch  
**5ML-P** cherry maple on birch  
**EW-P** eggshell white (EW Durasyn on chassis)

**B** black  
**EW** eggshell white  
**S** silver

**pulls** all brio units ship standard with (square) pulls  
optional (twisted) pulls are available for no  
upcharge - specify (OP) for optional pull

**durasyn**  
modesty  
grade 1

**chemcast™**  
modesty  
grade 3

**INSERTS**  
**BP** black pearl  
**BL** black  
**CH** chinchilla  
**CT** cactus  
**EW** eggshell white  
**FG** fog  
**NB** natural beige  
**NG** northsea gray  
**PE** pearl  
**RK** rock  
**SD** sand  
**ST** sunset  
**TW** tumbleweed

**2025** black  
**2069** blue  
**2247** white  
**2370** bronze  
**P-95** clear

brío

| 2200 series

| wood top, veneer chassis, veneer drawer fronts

| laminate top, veneer chassis, veneer drawer fronts



veneer top grade 1 insert		veneer top grade 2 insert		veneer top grade 3 insert		laminate top grade 1 insert		laminate top grade 2 insert		laminate top grade 3 insert	
list pricing zone 1	zone 2	list pricing zone 1	zone 2	list pricing zone 1	zone 2	list pricing zone 1	zone 2	list pricing zone 1	zone 2	list pricing zone 1	zone 2
3,237	3,497					3,066	3,311				
3,237	3,497					3,066	3,311				
3,827	4,134					3,655	3,947				
3,827	4,134					3,655	3,947				
2,607	2,815					2,436	2,630				
2,607	2,815					2,436	2,630				

laminat	INSERTS	veneer	INSERTS	fabric	INSERTS	momentum	INSERTS
modesty grade 1	<b>NB-P</b> natural birch on birch <b>CB-P</b> cherry birch on birch <b>2ML-P</b> natural maple on birch <b>3ML-P</b> light maple on birch <b>4ML-P</b> medium maple on birch <b>5ML-P</b> cherry on maple on birch <b>6LC-P</b> light cherry on birch <b>7MC-P</b> medium cherry on birch <b>8DC-P</b> dark cherry on birch <b>3L-P</b> saddle on walnut <b>4L-P</b> dark mahogany on walnut <b>25B-P</b> ebony on walnut <b>25M-P</b> mahogany on walnut <b>MB-P</b> mocha on birch <b>BA</b> black ashwood <b>BB</b> bethany beige <b>CF</b> copper fusion <b>CL</b> chili <b>CM</b> cardamom fiber <b>CN</b> cinnamon <b>CO</b> coriander fiber <b>CU</b> curacao fiber <b>EW</b> eggshell white <b>GS</b> graphite specktrum <b>GV</b> galvan <b>NV</b> negotiating in geneva <b>NV-G</b> negotiating in geneva gloss <b>OS</b> olive serenity <b>RA</b> rock of ages <b>SU</b> sugar fiber <b>TY</b> thyme fiber <b>WH</b> wheat fiber	modesty grade 1	<b>NB-W</b> natural birch on birch <b>CB-W</b> cherry birch on birch <b>6LC-W</b> light cherry on birch <b>7MC-W</b> medium cherry on birch <b>8DC-W</b> dark cherry on birch <b>MB-W</b> mocha birch on birch <b>2ML-W</b> natural maple on birch <b>3ML-W</b> light maple on birch <b>4ML-W</b> medium maple on birch <b>5ML-W</b> cherry on birch <b>1NC-W</b> natural cherry on cherry <b>2HC-W</b> honey cherry on cherry <b>9BC-W</b> burgundy cherry on cherry <b>88M-W</b> mahogany on cherry <b>2KL-W</b> sepia on walnut <b>3L-W</b> saddle on walnut <b>4L-W</b> dark mahogany on walnut <b>25C-W</b> cherry on walnut <b>25M-W</b> mahogany on walnut <b>25B-W</b> ebony on walnut <b>EW-W</b> eggshell white on birch <b>2ML-W</b> natural maple on birch <b>3ML-W</b> light maple on birch <b>4ML-W</b> medium maple on birch <b>5ML-W</b> cherry maple on birch	<b>modesty</b> grade 2 <b>mayer</b> catalyst <b>mayer</b> equation <b>mayer</b> lunar <b>mayer</b> paramount <b>mayer</b> element	<b>322-001</b> rouge <b>322-009</b> copper <b>322-007</b> bronze <b>322-013</b> limelight <b>322-004</b> denim <b>322-000</b> taupe <b>323-001</b> rosewood <b>323-009</b> russet <b>323-019</b> amber <b>323-013</b> limelight <b>323-004</b> indigo <b>323-000</b> bronze <b>332-001</b> pomegranate <b>334-009</b> copper <b>334-007</b> moonbeam <b>334-013</b> limelight <b>334-004</b> cobalt <b>334-000</b> mocha <b>302-001</b> paprika <b>302-009</b> copper <b>302-002</b> bamboo <b>302-023</b> willow <b>302-014</b> admiral <b>302-000</b> chocolate <b>316-009</b> copper <b>316-019</b> red clay <b>316-008</b> plum <b>316-003</b> feldspar <b>316-024</b> turquoise <b>316-004</b> sapphire <b>316-010</b> taupe <b>316-006</b> smoke	<b>axis</b> <b>momentum</b> russo <b>momentum</b> origin	<b>09102740</b> paprika <b>09102773</b> summer <b>09102718</b> grove <b>09102707</b> denim <b>09102729</b> noir <b>09102751</b> truffie <b>09097955</b> ascot <b>09097966</b> coin <b>09098021</b> trellis <b>09097977</b> imperial <b>09098010</b> shadow <b>09097999</b> mocha <b>09067502</b> garnet <b>09067481</b> amethyst <b>09067497</b> eco <b>09067529</b> sapphire <b>09067518</b> jet <b>09067540</b> steel <b>09067486</b> bayou <b>09067525</b> myth <b>09067492</b> bottle <b>09067532</b> sodalite <b>09067512</b> iron <b>09067545</b> system

## F2272-6B-W-B-F

series - dimensions & unit identification (type) - top/chassis finish - top material - spacer/frame finish - modesty  
modesty choice - select grade and insert description of material  
wall hung units do not have option of wood or laminate tops

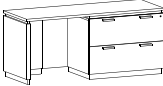
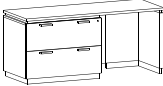
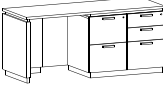
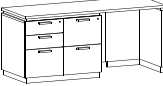
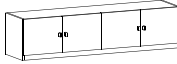
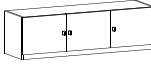
	model number	description	d	w	h	freight
	C2266R-2F - _ - _ - _	single pedestal credenza right lateral file pedestal veneer modesty	24	66	29	class 125 cwt 235 lb cu ft 35
	C2266L-2F - _ - _ - _	single pedestal credenza left lateral file pedestal veneer modesty	24	66	29	class 125 cwt 235 lb cu ft 35
	C2266R-5D - _ - _ - _	single pedestal credenza right multi-file pedestal veneer modesty	24	66	29	class 125 cwt 295 lb cu ft 28
	C2266L-5D - _ - _ - _	single pedestal credenza left multi-file pedestal veneer modesty	24	66	29	class 125 cwt 295 lb cu ft 28
	WH2266 - _ - _	66" wide wall hung overhead four wood doors	16	66	16	class 125 cwt 110 lb cu ft 13
	WH2254 - _ - _	54" wide wall hung overhead three wood doors	16	54	16	class 125 cwt 100 lb cu ft 11

**top material**  
P laminate top  
W veneer top

**modesty option key**  
W= veneer  
L= laminate  
D= durasyn  
C.O.M.  
A= acrilux  
F= fabric  
C= chemcast™

**grade 1** wood, laminate,  
durasyn, c.o.m.  
**grade 2** acrilux (5 unit minimum),  
fabric  
**grade 3** chemcast™

**edge**

G

**wood top & chassis finish**

**laminate top finish**

**spacer & frame finish**

**6LC-W** light cherry on birch  
**7MC-W** medium cherry on birch  
**8DC-W** dark cherry on birch  
**MB-W** mocha birch on birch  
**NB-W** natural birch on birch  
**CB-W** cherry birch on birch  
**2ML-W** natural maple on birch  
**3ML-W** light maple on birch  
**4ML-W** medium maple on birch  
**5ML-W** cherry maple on birch

**6LC-P** light cherry on birch  
**7MC-P** medium cherry on birch  
**8DC-P** dark cherry on birch  
**NB-P** natural on birch  
**MB-P** mocha on birch  
**CB-P** cherry on birch  
**2ML-P** natural maple on birch  
**3ML-P** light maple on birch  
**4ML-P** medium maple on birch  
**5ML-P** cherry maple on birch  
**EW-P** eggshell white (EW Durasyn on chassis)

**B** black  
**EW** eggshell white  
**S** silver

**pulls** all brio units ship standard with (square) pulls  
optional (twisted) pulls are available for no  
upcharge - specify (OP) for optional pull

**durasyn**  
modesty  
grade 1

**chemcast™**  
modesty  
grade 3

**INSERTS**  
BP black pearl  
BL black  
CH chinchilla  
CT cactus  
EW eggshell white  
FG fog  
NB natural beige  
NG northsea gray  
PE pearl  
RK rock  
SD sand  
ST sunset  
TW tumbleweed

**2025** black  
**2069** blue  
**2247** white  
**2370** bronze  
**P-95** clear

brío

| 2200 series

| wood top, veneer chassis, veneer drawer fronts

| laminate top, veneer chassis, veneer drawer fronts



veneer top grade 1 insert		veneer top grade 2 insert		veneer top grade 3 insert		laminate top grade 1 insert		laminate top grade 2 insert		laminate top grade 3 insert	
list pricing zone 1	zone 2	list pricing zone 1	zone 2	list pricing zone 1	zone 2	list pricing zone 1	zone 2	list pricing zone 1	zone 2	list pricing zone 1	zone 2
3,105	3,353					2,933	3,167				
3,105	3,353					2,933	3,167				
3,689	3,983					3,517	3,797				
3,689	3,983					3,517	3,797				
1,792	1,935										
1,618	1,747										

laminat	INSERTS	veneer	INSERTS	fabric	INSERTS	momentum	INSERTS
modesty grade 1	<b>NB-P</b> natural birch on birch <b>CB-P</b> cherry birch on birch <b>2ML-P</b> natural maple on birch <b>3ML-P</b> light maple on birch <b>4ML-P</b> medium maple on birch <b>5ML-P</b> cherry on maple on birch <b>6LC-P</b> light cherry on birch <b>7MC-P</b> medium cherry on birch <b>8DC-P</b> dark cherry on birch <b>3L-P</b> saddle on walnut <b>4L-P</b> dark mahogany on walnut <b>25B-P</b> ebony on walnut <b>25M-P</b> mahogany on walnut <b>MB-P</b> mocha on birch <b>BA</b> black ashwood <b>BB</b> bethany beige <b>CF</b> copper fusion <b>CL</b> chili <b>CM</b> cardamom fiber <b>CN</b> cinnamon <b>CO</b> coriander fiber <b>CU</b> curacao fiber <b>EW</b> eggshell white <b>GS</b> graphite specktrum <b>GV</b> galvan <b>NV</b> negotiating in geneva <b>NV-G</b> negotiating in geneva gloss <b>OS</b> olive serenity <b>RA</b> rock of ages <b>SU</b> sugar fiber <b>TY</b> thyme fiber <b>WH</b> wheat fiber	<b>NB-W</b> natural birch on birch <b>CB-W</b> cherry birch on birch <b>6LC-W</b> light cherry on birch <b>7MC-W</b> medium cherry on birch <b>8DC-W</b> dark cherry on birch <b>MB-W</b> mocha birch on birch <b>2ML-W</b> natural maple on birch <b>3ML-W</b> light maple on birch <b>4ML-W</b> medium maple on birch <b>5ML-W</b> cherry on birch <b>1NC-W</b> natural cherry on cherry <b>2HC-W</b> honey cherry on cherry <b>9BC-W</b> burgundy cherry on cherry <b>88M-W</b> mahogany on cherry <b>2KL-W</b> sepia on walnut <b>3L-W</b> saddle on walnut <b>4L-W</b> dark mahogany on walnut <b>25C-W</b> cherry on walnut <b>25M-W</b> mahogany on walnut <b>25B-W</b> ebony on walnut <b>EW-W</b> eggshell white on birch <b>2ML-W</b> natural maple on birch <b>3ML-W</b> light maple on birch <b>4ML-W</b> medium maple on birch <b>5ML-W</b> cherry maple on birch	<b>modesty</b> grade 2 <b>mayer</b> catalyst <b>mayer</b> equation <b>mayer</b> lunar <b>mayer</b> paramount <b>mayer</b> element	<b>322-001</b> rouge <b>322-009</b> copper <b>322-007</b> bronze <b>322-013</b> limelight <b>322-004</b> denim <b>322-000</b> taupe <b>323-001</b> rosewood <b>323-009</b> russet <b>323-019</b> amber <b>323-013</b> limelight <b>323-004</b> indigo <b>323-000</b> bronze <b>332-001</b> pomegranate <b>334-009</b> copper <b>334-007</b> moonbeam <b>334-013</b> limelight <b>334-004</b> cobalt <b>334-000</b> mocha <b>302-001</b> paprika <b>302-009</b> copper <b>302-002</b> bamboo <b>302-023</b> willow <b>302-014</b> admiral <b>302-000</b> chocolate <b>316-009</b> copper <b>316-019</b> red clay <b>316-008</b> plum <b>316-003</b> feldspar <b>316-024</b> turquoise <b>316-004</b> sapphire <b>316-010</b> taupe <b>316-006</b> smoke	<b>axis</b> <b>momentum</b> russo <b>momentum</b> origin	<b>09102740</b> paprika <b>09102773</b> summer <b>09102718</b> grove <b>09102707</b> denim <b>09102729</b> noir <b>09102751</b> truffie <b>09097955</b> ascot <b>09097966</b> coin <b>09098021</b> trellis <b>09097977</b> imperial <b>09098010</b> shadow <b>09097999</b> mocha <b>09067502</b> garnet <b>09067481</b> amethyst <b>09067497</b> eco <b>09067529</b> sapphire <b>09067518</b> jet <b>09067540</b> steel <b>09067486</b> bayou <b>09067525</b> myth <b>09067492</b> bottle <b>09067532</b> sodalite <b>09067512</b> iron <b>09067545</b> system	

## F2272-6B-W-B-F

series - dimensions & unit identification (type) - top/chassis finish - top material - spacer/frame finish - modesty

modesty choice - select grade and insert description of material

no spacers with these units - wall hung units do not have option of wood or laminate tops

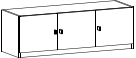
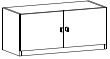
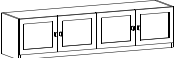
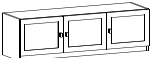
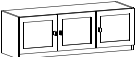
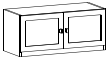
	model number	description	d	w	h	freight
	WH2248 - _ - _	48" wide wall hung overhead three wood doors	16	48	16	class 125 cwt 90 lb cu ft 10
	WH2236 - _ - _	36" wide wall hung overhead two wood doors	16	36	16	class 125 cwt 75 lb cu ft 8
	WHF2266 - _ - _	66" wide wall hung overhead four hinged wood doors with framed door "inserts"	16	66	16	class 125 cwt 100 lb cu ft 13
	WHF2254 - _ - _ - _	54" wide wall hung overhead three hinged wood doors with framed door "inserts"	16	54	16	class 125 cwt 100 lb cu ft 11
	WHF2248 - _ - _ - _	48" wide wall hung overhead three hinged wood doors with framed door "inserts"	16	48	16	class 125 cwt 90 lb cu ft 10
	WHF2236 - _ - _ - _	36" wide wall hung overhead two hinged wood doors with framed door "inserts"	16	36	16	class 125 cwt 75 lb cu ft 8

**top material**

**P** laminate top  
**W** veneer top

**modesty option key**

**W**= veneer  
**L**= laminate  
**D**= durasyn  
**C.O.M.**  
**A**= acrilux  
**F**= fabric  
**C**= chemcast™

**grade 1**

wood, laminate,  
durasyn, c.o.m.  
**grade 2** acrilux (5 unit minimum),  
fabric  
**grade 3** chemcast™

**edge**

**G**

**wood top & chassis finish**

**6LC-W** light cherry on birch  
**7MC-W** medium cherry on birch  
**8DC-W** dark cherry on birch  
**MB-W** mocha birch on birch  
**NB-W** natural birch on birch  
**CB-W** cherry birch on birch  
**2ML-W** natural maple on birch  
**3ML-W** light maple on birch  
**4ML-W** medium maple on birch  
**5ML-W** cherry maple on birch

**laminate top finish**

**6LC-P** light cherry on birch  
**7MC-P** medium cherry on birch  
**8DC-P** dark cherry on birch  
**NB-P** natural on birch  
**MB-P** mocha on birch  
**CB-P** cherry on birch  
**2ML-P** natural maple on birch  
**3ML-P** light maple on birch  
**4ML-P** medium maple on birch  
**5ML-P** cherry maple on birch  
**EW-P** eggshell white (EW Durasyn on chassis)

**spacer & frame finish**

**B** black  
**EW** eggshell white  
**S** silver

**durasyn**

modesty  
grade 1

**chemcast™**

modesty  
grade 3

**INSERTS**

**BP** black pearl  
**BL** black  
**CH** chinchilla  
**CT** cactus  
**EW** eggshell white  
**FG** fog  
**NB** natural beige  
**NG** northsea gray  
**PE** pearl  
**RK** rock  
**SD** sand  
**ST** sunset  
**TW** tumbleweed

**2025** black  
**2069** blue  
**2247** white  
**2370** bronze  
**P-95** clear

**pulls**

all brio units ship standard with (square) pulls  
optional (twisted) pulls are available for no  
upcharge - specify (OP) for optional pull

brío

| 2200 series

| wood top, veneer chassis, veneer drawer fronts

| laminate top, veneer chassis, veneer drawer fronts



veneer top grade 1 insert		veneer top grade 2 insert		veneer top grade 3 insert		laminate top grade 1 insert		laminate top grade 2 insert		laminate top grade 3 insert	
list pricing zone 1	zone 2	list pricing zone 1	zone 2	list pricing zone 1	zone 2	list pricing zone 1	zone 2	list pricing zone 1	zone 2	list pricing zone 1	zone 2
1,541	1,665										
1,010	1,090										
1,885	2,035	1,953	2,109	2,245	2,424						
1,628	1,758	1,687	1,823	1,939	2,094						
1,539	1,662	1,594	1,722	1,833	1,980						
1,209	1,306	1,252	1,353	1,437	1,552						

laminat	INSERTS	veneer	INSERTS	fabric	INSERTS	momentum	INSERTS
modesty grade 1	<b>NB-P</b> natural birch on birch <b>CB-P</b> cherry birch on birch <b>2ML-P</b> natural maple on birch <b>3ML-P</b> light maple on birch <b>4ML-P</b> medium maple on birch <b>5ML-P</b> cherry on maple on birch <b>6LC-P</b> light cherry on birch <b>7MC-P</b> medium cherry on birch <b>8DC-P</b> dark cherry on birch <b>3L-P</b> saddle on walnut <b>4L-P</b> dark mahogany on walnut <b>25B-P</b> ebony on walnut <b>25M-P</b> mahogany on walnut <b>MB-P</b> mocha on birch <b>BA</b> black ashwood <b>BB</b> bethany beige <b>CF</b> copper fusion <b>CL</b> chili <b>CM</b> cardamom fiber <b>CN</b> cinnamon <b>CO</b> coriander fiber <b>CU</b> curacao fiber <b>EW</b> eggshell white <b>GS</b> graphite specktrum <b>GV</b> galvan <b>NV</b> negotiating in geneva <b>NV-G</b> negotiating in geneva gloss <b>OS</b> olive serenity <b>RA</b> rock of ages <b>SU</b> sugar fiber <b>TY</b> thyme fiber <b>WH</b> wheat fiber	modesty grade 1	<b>NB-W</b> natural birch on birch <b>CB-W</b> cherry birch on birch <b>6LC-W</b> light cherry on birch <b>7MC-W</b> medium cherry on birch <b>8DC-W</b> dark cherry on birch <b>MB-W</b> mocha birch on birch <b>2ML-W</b> natural maple on birch <b>3ML-W</b> light maple on birch <b>4ML-W</b> medium maple on birch <b>5ML-W</b> cherry on birch <b>1NC-W</b> natural cherry on cherry <b>2HC-W</b> honey cherry on cherry <b>9BC-W</b> burgundy cherry on cherry <b>88M-W</b> mahogany on cherry <b>2KL-W</b> sepia on walnut <b>3L-W</b> saddle on walnut <b>4L-W</b> dark mahogany on walnut <b>25C-W</b> cherry on walnut <b>25M-W</b> mahogany on walnut <b>25B-W</b> ebony on walnut <b>EW-W</b> eggshell white on birch <b>2ML-W</b> natural maple on birch <b>3ML-W</b> light maple on birch <b>4ML-W</b> medium maple on birch <b>5ML-W</b> cherry maple on birch	<b>322-001</b> rouge <b>322-009</b> copper <b>322-007</b> bronze <b>322-013</b> limelight <b>322-004</b> denim <b>322-000</b> taupe  <b>323-001</b> rosewood <b>323-009</b> russet <b>323-019</b> amber <b>323-013</b> limelight <b>323-004</b> indigo <b>323-000</b> bronze  <b>332-001</b> pomegranate <b>334-009</b> copper <b>334-007</b> moonbeam <b>334-013</b> limelight <b>334-004</b> cobalt <b>334-000</b> mocha  <b>302-001</b> paprika <b>302-009</b> copper <b>302-002</b> bamboo <b>302-023</b> willow <b>302-014</b> admiral <b>302-000</b> chocolate  <b>316-009</b> copper <b>316-019</b> red clay <b>316-008</b> plum <b>316-003</b> feldspar <b>316-024</b> turquoise <b>316-004</b> sapphire <b>316-010</b> taupe <b>316-006</b> smoke	axis  russo  origin	<b>09102740</b> paprika <b>09102773</b> summer <b>09102718</b> grove <b>09102707</b> denim <b>09102729</b> noir <b>09102751</b> truffie  <b>09097955</b> ascot <b>09097966</b> coin <b>09098021</b> trellis <b>09097977</b> imperial <b>09098010</b> shadow <b>09097999</b> mocha  <b>09067502</b> garnet <b>09067481</b> amethyst <b>09067497</b> eco <b>09067529</b> sapphire <b>09067518</b> jet <b>09067540</b> steel <b>09067486</b> bayou <b>09067525</b> myth <b>09067492</b> bottle <b>09067532</b> sodalite <b>09067512</b> iron <b>09067545</b> system	

## F2272-6B-W-B-F

series - dimensions & unit identification (type) - top/chassis finish - top material - spacer/frame finish - modesty

modesty choice - select grade and insert description of material

no spacers with these units - wall hung units do not have option of wood or laminate tops

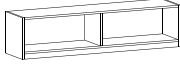
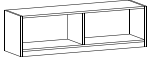
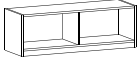
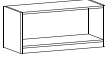
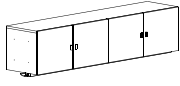
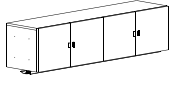
	model number	description	d	w	h	freight
	WHO2266 - _ - _	66" wide wall hung overhead open	15.25	66	16	class 125 cwt 90 lb cu ft 13
	WHO2254 - _ - _	54" wide wall hung overhead open	15.25	54	16	class 125 cwt 85 lb cu ft 12
	WHO2248 - _ - _	48" wide wall hung overhead open	15.25	48	16	class 125 cwt 75 lb cu ft 10
	WHO2236 - _ - - - -	36" wide wall hung overhead open	15.25	36	16	class 125 cwt 65 lb cu ft 8
	CHU2272 - _ - _	72" wide case hung overhead 4 wood doors  <i>CASE HUNG OVERHEAD UNITS ARE TO BE USED IN CONJUNCTION WITH CASE TOWERS, END PANELS OR HUTCHES: NOT FOR DIRECT APPLICATION TO WALLS.</i>	16	72	17	class 125 cwt 125 lb cu ft 16
	CHU2266 - _ - _	66" wide case hung overhead 4 wood doors  <i>CASE HUNG OVERHEAD UNITS ARE TO BE USED IN CONJUNCTION WITH CASE TOWERS, END PANELS OR HUTCHES: NOT FOR DIRECT APPLICATION TO WALLS.</i>	16	66	17	class 125 cwt 115 lb cu ft 15

**top material**  
P laminate top  
W veneer top

**modesty option key**  
W= veneer  
L= laminate  
D= durasyn  
C.O.M.  
A= acrilux  
F= fabric  
C= chemcast™

**grade 1** wood, laminate,  
durasyn, c.o.m.  
**grade 2** acrilux (5 unit minimum),  
fabric  
**grade 3** chemcast™

**edge**

**wood top & chassis finish**

**laminate top finish**

**spacer & frame finish**

**6LC-W** light cherry on birch  
**7MC-W** medium cherry on birch  
**8DC-W** dark cherry on birch  
**MB-W** mocha birch on birch  
**NB-W** natural birch on birch  
**CB-W** cherry birch on birch  
**2ML-W** natural maple on birch  
**3ML-W** light maple on birch  
**4ML-W** medium maple on birch  
**5ML-W** cherry maple on birch

**6LC-P** light cherry on birch  
**7MC-P** medium cherry on birch  
**8DC-P** dark cherry on birch  
**NB-P** natural on birch  
**MB-P** mocha on birch  
**CB-P** cherry on birch  
**2ML-P** natural maple on birch  
**3ML-P** light maple on birch  
**4ML-P** medium maple on birch  
**5ML-P** cherry maple on birch  
**EW-P** eggshell white (EW Durasyn on chassis)

**B** black  
**EW** eggshell white  
**S** silver

**pulls** all brio units ship standard with (square) pulls  
optional (twisted) pulls are available for no  
upcharge - specify (OP) for optional pull

**durasyn**  
modesty  
grade 1

**chemcast™**  
modesty  
grade 3

**INSERTS**  
**BP** black pearl  
**BL** black  
**CH** chinchilla  
**CT** cactus  
**EW** eggshell white  
**FG** fog  
**NB** natural beige  
**NG** northsea gray  
**PE** pearl  
**RK** rock  
**SD** sand  
**ST** sunset  
**TW** tumbleweed

**2025** black  
**2069** blue  
**2247** white  
**2370** bronze  
**P-95** clear







## F2272-6B-W-B-F

series - dimensions & unit identification (type) - **top/chassis finish** - **top material** - **spacer/frame finish** - **modesty**

modesty choice - select grade and insert description of material

**no spacers with these units - wall hung units do not have option of wood or laminate tops**

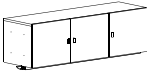
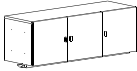
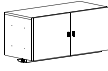
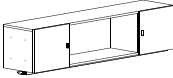
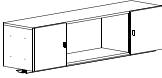
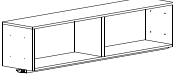
	model number	description	d	w	h	freight
	CHU2254 - _ - _	54" wide case hung overhead 3 wood doors  <i>CASE HUNG OVERHEAD UNITS ARE TO BE USED IN CONJUNCTION WITH CASE TOWERS, END PANELS OR HUTCHES: NOT FOR DIRECT APPLICATION TO WALLS.</i>	16	54	17	class 125 cwt 105 lb cu ft 14
	CHU2248 - _ - _	48" wide case hung overhead 3 wood doors  <i>CASE HUNG OVERHEAD UNITS ARE TO BE USED IN CONJUNCTION WITH CASE TOWERS, END PANELS OR HUTCHES: NOT FOR DIRECT APPLICATION TO WALLS.</i>	16	48	17	class 125 cwt 105 lb cu ft 14
	CHU2236 - _ - _	36" wide case hung overhead 2 wood doors  <i>CASE HUNG OVERHEAD UNITS ARE TO BE USED IN CONJUNCTION WITH CASE TOWERS, END PANELS OR HUTCHES: NOT FOR DIRECT APPLICATION TO WALLS.</i>	16	36	17	class 125 cwt 90 lb cu ft 12
	CHD2272 - _ - _	72" wide case hung overhead 2 wood doors open in the middle  <i>CASE HUNG OVERHEAD UNITS ARE TO BE USED IN CONJUNCTION WITH CASE TOWERS, END PANELS OR HUTCHES: NOT FOR DIRECT APPLICATION TO WALLS.</i>	16	72	17	class 125 cwt 120 lb cu ft 16
	CHD2266 - _ - _	66" wide case hung overhead 2 wood doors open in the middle  <i>CASE HUNG OVERHEAD UNITS ARE TO BE USED IN CONJUNCTION WITH CASE TOWERS, END PANELS OR HUTCHES: NOT FOR DIRECT APPLICATION TO WALLS.</i>	16	66	17	class 125 cwt 110 lb cu ft 15
	CHO2272 - _	72" wide case hung overhead open  <i>CASE HUNG OVERHEAD UNITS ARE TO BE USED IN CONJUNCTION WITH CASE TOWERS, END PANELS OR HUTCHES: NOT FOR DIRECT APPLICATION TO WALLS.</i>	15.25	72	17	class 125 cwt 115 lb cu ft 16

**top material**

**P** laminate top  
**W** veneer top

**modesty option key**

**W**= veneer  
**L**= laminate  
**D**= durasyn  
**C.O.M.**  
**A**= acrilux  
**F**= fabric  
**C**= chemcast™

**grade 1**

wood, laminate, durasyn, c.o.m.

**grade 2**

acrilux (5 unit minimum), fabric

**grade 3**

chemcast™

**wood top & chassis finish**

**6LC-W** light cherry on birch  
**7MC-W** medium cherry on birch  
**8DC-W** dark cherry on birch  
**MB-W** mocha birch on birch  
**NB-W** natural birch on birch  
**CB-W** cherry birch on birch  
**2ML-W** natural maple on birch  
**3ML-W** light maple on birch  
**4ML-W** medium maple on birch  
**5ML-W** cherry maple on birch

**laminate top finish**

**6LC-P** light cherry on birch  
**7MC-P** medium cherry on birch  
**8DC-P** dark cherry on birch  
**NB-P** natural on birch  
**MB-P** mocha on birch  
**CB-P** cherry on birch  
**2ML-P** natural maple on birch  
**3ML-P** light maple on birch  
**4ML-P** medium maple on birch  
**5ML-P** cherry maple on birch  
**EW-P** eggshell white (EW Durasyn on chassis)

**spacer & frame finish**

**B** black  
**EW** eggshell white  
**S** silver

**durasyn**

modesty grade 1

**chemcast™**

modesty grade 3

**INSERTS**

**BP** black pearl  
**BL** black  
**CH** chinchilla  
**CT** cactus  
**EW** eggshell white  
**FG** fog  
**NB** natural beige  
**NG** northsea gray  
**PE** pearl  
**RK** rock  
**SD** sand  
**ST** sunset  
**TW** tumbleweed  
  
**2025** black  
**2069** blue  
**2247** white  
**2370** bronze  
**P-95** clear

**edge**



**pulls**

all brio units ship standard with (square) pulls  
optional (twisted) pulls are available for no upcharge - specify (OP) for optional pull

brío

| 2200 series

| wood top, veneer chassis, veneer drawer fronts

| laminate top, veneer chassis, veneer drawer fronts



veneer top grade 1 insert		veneer top grade 2 insert		veneer top grade 3 insert		laminate top grade 1 insert		laminate top grade 2 insert		laminate top grade 3 insert	
list pricing zone 1	zone 2	list pricing zone 1	zone 2	list pricing zone 1	zone 2	list pricing zone 1	zone 2	list pricing zone 1	zone 2	list pricing zone 1	zone 2
1,177	1,271										
1,065	1,151										
775	838										
1,377	1,487										
1,206	1,302										
1,190	1,284										

laminat	INSERTS	veneer	INSERTS	fabric	INSERTS	momentum	INSERTS
modesty grade 1	<b>NB-P</b> natural birch on birch <b>CB-P</b> cherry birch on birch <b>2ML-P</b> natural maple on birch <b>3ML-P</b> light maple on birch <b>4ML-P</b> medium maple on birch <b>5ML-P</b> cherry on maple on birch <b>6LC-P</b> light cherry on birch <b>7MC-P</b> medium cherry on birch <b>8DC-P</b> dark cherry on birch <b>3L-P</b> saddle on walnut <b>4L-P</b> dark mahogany on walnut <b>25B-P</b> ebony on walnut <b>25M-P</b> mahogany on walnut <b>MB-P</b> mocha on birch <b>BA</b> black ashwood <b>BB</b> bethany beige <b>CF</b> copper fusion <b>CL</b> chili <b>CM</b> cardamom fiber <b>CN</b> cinnamon <b>CO</b> coriander fiber <b>CU</b> curacao fiber <b>EW</b> eggshell white <b>GS</b> graphite specktrum <b>GV</b> galvan <b>NV</b> negotiating in geneva <b>NV-G</b> negotiating in geneva gloss <b>OS</b> olive serenity <b>RA</b> rock of ages <b>SU</b> sugar fiber <b>TY</b> thyme fiber <b>WH</b> wheat fiber	<b>NB-W</b> natural birch on birch <b>CB-W</b> cherry birch on birch <b>6LC-W</b> light cherry on birch <b>7MC-W</b> medium cherry on birch <b>8DC-W</b> dark cherry on birch <b>MB-W</b> mocha birch on birch <b>2ML-W</b> natural maple on birch <b>3ML-W</b> light maple on birch <b>4ML-W</b> medium maple on birch <b>5ML-W</b> cherry on birch <b>1NC-W</b> natural cherry on cherry <b>2HC-W</b> honey cherry on cherry <b>9BC-W</b> burgundy cherry on cherry <b>88M-W</b> mahogany on cherry <b>2KL-W</b> sepia on walnut <b>3L-W</b> saddle on walnut <b>4L-W</b> dark mahogany on walnut <b>25C-W</b> cherry on walnut <b>25M-W</b> mahogany on walnut <b>25B-W</b> ebony on walnut <b>EW-W</b> eggshell white on birch <b>2ML-W</b> natural maple on birch <b>3ML-W</b> light maple on birch <b>4ML-W</b> medium maple on birch <b>5ML-W</b> cherry maple on birch	<b>modesty</b> grade 2 <b>mayer</b> catalyst <b>mayer</b> equation <b>mayer</b> lunar <b>mayer</b> paramount <b>mayer</b> element	<b>322-001</b> rouge <b>322-009</b> copper <b>322-007</b> bronze <b>322-013</b> limelight <b>322-004</b> denim <b>322-000</b> taupe <b>323-001</b> rosewood <b>323-009</b> russet <b>323-019</b> amber <b>323-013</b> limelight <b>323-004</b> indigo <b>323-000</b> bronze <b>332-001</b> pomegranate <b>334-009</b> copper <b>334-007</b> moonbeam <b>334-013</b> limelight <b>334-004</b> cobalt <b>334-000</b> mocha <b>302-001</b> paprika <b>302-009</b> copper <b>302-002</b> bamboo <b>302-023</b> willow <b>302-014</b> admiral <b>302-000</b> chocolate <b>316-009</b> copper <b>316-019</b> red clay <b>316-008</b> plum <b>316-003</b> feldspar <b>316-024</b> turquoise <b>316-004</b> sapphire <b>316-010</b> taupe <b>316-006</b> smoke	<b>axis</b> <b>momentum</b> russo <b>momentum</b> origin	<b>09102740</b> paprika <b>09102773</b> summer <b>09102718</b> grove <b>09102707</b> denim <b>09102729</b> noir <b>09102751</b> truffie <b>09097955</b> ascot <b>09097966</b> coin <b>09098021</b> trellis <b>09097977</b> imperial <b>09098010</b> shadow <b>09097999</b> mocha <b>09067502</b> garnet <b>09067481</b> amethyst <b>09067497</b> eco <b>09067529</b> sapphire <b>09067518</b> jet <b>09067540</b> steel <b>09067486</b> bayou <b>09067525</b> myth <b>09067492</b> bottle <b>09067532</b> sodalite <b>09067512</b> iron <b>09067545</b> system	

brío  
2200

## F2272-6B-W-B-F

series - dimensions & unit identification (type) - **top/chassis finish** - **top material** - **spacer/frame finish** - **modesty**  
 modesty choice - select grade and insert description of material  
**no spacers on OU units - wall hung units do not have option of wood or laminate tops**

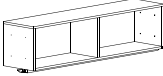
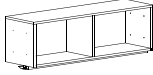
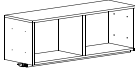
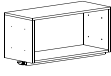
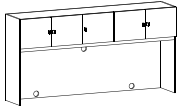
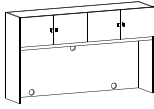
	model number	description	d w h	freight
	CHO2266 - __	66" wide case hung overhead open  <i>CASE HUNG OVERHEAD UNITS ARE TO BE USED IN CONJUNCTION WITH CASE TOWERS, END PANELS OR HUTCHES: NOT FOR DIRECT APPLICATION TO WALLS.</i>	15.25 66 17	class 125 cwt 105 lb cu ft 15
	CHO2254 - __	54" wide case hung overhead open  <i>CASE HUNG OVERHEAD UNITS ARE TO BE USED IN CONJUNCTION WITH CASE TOWERS, END PANELS OR HUTCHES: NOT FOR DIRECT APPLICATION TO WALLS.</i>	15.25 54 17	class 125 cwt 75 lb cu ft 10
	CHO2248 - __	48" wide case hung overhead open  <i>CASE HUNG OVERHEAD UNITS ARE TO BE USED IN CONJUNCTION WITH CASE TOWERS, END PANELS OR HUTCHES: NOT FOR DIRECT APPLICATION TO WALLS.</i>	15.25 48 17	class 125 cwt 75 lb cu ft 10
	CHO2236 - __	36" wide case hung overhead open  <i>CASE HUNG OVERHEAD UNITS ARE TO BE USED IN CONJUNCTION WITH CASE TOWERS, END PANELS OR HUTCHES: NOT FOR DIRECT APPLICATION TO WALLS.</i>	15.25 36 17	class 125 cwt 50 lb cu ft 8
	OU2284 - __ - __	84" overhead storage unit five hinged doors three wire management grommets	16.5 83.75 42.5	class 125 cwt 205 lb cu ft 40
	OU2272 - __ - __	72" overhead storage unit four hinged doors three wire management grommets	16.5 72 42.5	class 125 cwt 205 lb cu ft 40

**top material**  
**P** laminate top  
**W** veneer top

**modesty option key**  
**W**= veneer  
**L**= laminate  
**D**= durasyn  
**C.O.M.**  
**A**= acrilux  
**F**= fabric  
**C**= chemcast™

**grade 1** wood, laminate,  
 durasyn, c.o.m.  
**grade 2** acrilux (5 unit minimum),  
 fabric  
**grade 3** chemcast™

**edge**

**wood top & chassis finish**

**laminate top finish**

**spacer & frame finish**

**6LC-W** light cherry on birch  
**7MC-W** medium cherry on birch  
**8DC-W** dark cherry on birch  
**MB-W** mocha birch on birch  
**NB-W** natural birch on birch  
**CB-W** cherry birch on birch  
**2ML-W** natural maple on birch  
**3ML-W** light maple on birch  
**4ML-W** medium maple on birch  
**5ML-W** cherry maple on birch

**6LC-P** light cherry on birch  
**7MC-P** medium cherry on birch  
**8DC-P** dark cherry on birch  
**NB-P** natural on birch  
**MB-P** mocha on birch  
**CB-P** cherry on birch  
**2ML-P** natural maple on birch  
**3ML-P** light maple on birch  
**4ML-P** medium maple on birch  
**5ML-P** cherry maple on birch  
**EW-P** eggshell white (EW Durasyn on chassis)

**B** black  
**EW** eggshell white  
**S** silver

**durasyn**  
 modesty grade 1

**chemcast™**  
 modesty grade 3

**INSERTS**  
**BP** black pearl  
**BL** black  
**CH** chinchilla  
**CT** cactus  
**EW** eggshell white  
**FG** fog  
**NB** natural beige  
**NG** northsea gray  
**PE** pearl  
**RK** rock  
**SD** sand  
**ST** sunset  
**TW** tumbleweed

**2025** black  
**2069** blue  
**2247** white  
**2370** bronze  
**P-95** clear

**pulls** all brio units ship standard with (square) pulls  
 optional (twisted) pulls are available for no  
 upcharge - specify (OP) for optional pull



brío

| 2200 series

| wood top, veneer chassis, veneer drawer fronts

| laminate top, veneer chassis, veneer drawer fronts



veneer top grade 1 insert		veneer top grade 2 insert		veneer top grade 3 insert		laminate top grade 1 insert		laminate top grade 2 insert		laminate top grade 3 insert	
list pricing zone 1	zone 2	list pricing zone 1	zone 2	list pricing zone 1	zone 2	list pricing zone 1	zone 2	list pricing zone 1	zone 2	list pricing zone 1	zone 2
1,026	1,108										
607	656										
539	582										
403	437										
3,350	3,618										
2,599	2,808										

laminat	INSERTS	veneer	INSERTS	fabric	INSERTS	momentum	INSERTS
modesty grade 1	<b>NB-P</b> natural birch on birch <b>CB-P</b> cherry birch on birch <b>2ML-P</b> natural maple on birch <b>3ML-P</b> light maple on birch <b>4ML-P</b> medium maple on birch <b>5ML-P</b> cherry on maple on birch <b>6LC-P</b> light cherry on birch <b>7MC-P</b> medium cherry on birch <b>8DC-P</b> dark cherry on birch <b>3L-P</b> saddle on walnut <b>4L-P</b> dark mahogany on walnut <b>25B-P</b> ebony on walnut <b>25M-P</b> mahogany on walnut <b>MB-P</b> mocha on birch <b>BA</b> black ashwood <b>BB</b> bethany beige <b>CF</b> copper fusion <b>CL</b> chili <b>CM</b> cardamom fiber <b>CN</b> cinnamon <b>CO</b> coriander fiber <b>CU</b> curacao fiber <b>EW</b> eggshell white <b>GS</b> graphite specktrum <b>GV</b> galvan <b>NV</b> negotiating in geneva <b>NV-G</b> negotiating in geneva gloss <b>OS</b> olive serenity <b>RA</b> rock of ages <b>SU</b> sugar fiber <b>TY</b> thyme fiber <b>WH</b> wheat fiber	<b>NB-W</b> natural birch on birch <b>CB-W</b> cherry birch on birch <b>6LC-W</b> light cherry on birch <b>7MC-W</b> medium cherry on birch <b>8DC-W</b> dark cherry on birch <b>MB-W</b> mocha birch on birch <b>2ML-W</b> natural maple on birch <b>3ML-W</b> light maple on birch <b>4ML-W</b> medium maple on birch <b>5ML-W</b> cherry on birch <b>1NC-W</b> natural cherry on cherry <b>2HC-W</b> honey cherry on cherry <b>9BC-W</b> burgundy cherry on cherry <b>88M-W</b> mahogany on cherry <b>2KL-W</b> sepia on walnut <b>3L-W</b> saddle on walnut <b>4L-W</b> dark mahogany on walnut <b>25C-W</b> cherry on walnut <b>25M-W</b> mahogany on walnut <b>25B-W</b> ebony on walnut <b>EW-W</b> eggshell white on birch <b>2ML-W</b> natural maple on birch <b>3ML-W</b> light maple on birch <b>4ML-W</b> medium maple on birch <b>5ML-W</b> cherry maple on birch	<b>modesty</b> grade 2 <b>mayer</b> catalyst <b>mayer</b> equation <b>mayer</b> lunar <b>mayer</b> paramount <b>mayer</b> element	<b>322-001</b> rouge <b>322-009</b> copper <b>322-007</b> bronze <b>322-013</b> limelight <b>322-004</b> denim <b>322-000</b> taupe <b>323-001</b> rosewood <b>323-009</b> russet <b>323-019</b> amber <b>323-013</b> limelight <b>323-004</b> indigo <b>323-000</b> bronze <b>332-001</b> pomegranate <b>334-009</b> copper <b>334-007</b> moonbeam <b>334-013</b> limelight <b>334-004</b> cobalt <b>334-000</b> mocha <b>302-001</b> paprika <b>302-009</b> copper <b>302-002</b> bamboo <b>302-023</b> willow <b>302-014</b> admiral <b>302-000</b> chocolate <b>316-009</b> copper <b>316-019</b> red clay <b>316-008</b> plum <b>316-003</b> feldspar <b>316-024</b> turquoise <b>316-004</b> sapphire <b>316-010</b> taupe <b>316-006</b> smoke	<b>axis</b> <b>momentum</b> russo <b>momentum</b> origin	<b>09102740</b> paprika <b>09102773</b> summer <b>09102718</b> grove <b>09102707</b> denim <b>09102729</b> noir <b>09102751</b> truffie <b>09097955</b> ascot <b>09097966</b> coin <b>09098021</b> trellis <b>09097977</b> imperial <b>09098010</b> shadow <b>09097999</b> mocha <b>09067502</b> garnet <b>09067481</b> amethyst <b>09067497</b> eco <b>09067529</b> sapphire <b>09067518</b> jet <b>09067540</b> steel <b>09067486</b> bayou <b>09067525</b> myth <b>09067492</b> bottle <b>09067532</b> sodalite <b>09067512</b> iron <b>09067545</b> system	

## F2272-6B-W-B-F

series - dimensions & unit identification (type) - top/chassis finish - top material - spacer/frame finish - modesty  
modesty choice - select grade and insert description of material  
no spacers on OU units - wall hung and overhead storage does not have an option of wood or laminate tops

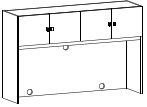
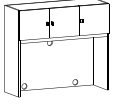
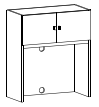
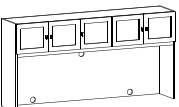
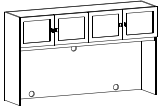
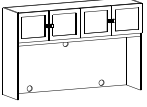
	model number	description	d	w	h	freight
	OU2266 - _ - _	66" overhead storage unit four hinged doors three wire management grommets	16.5	66	42.5	class 125 cwt 180 lb cu ft 26
	OU2248 - _ - _	48" overhead storage unit three hinged doors three wire management grommets	16.5	48	42.5	class 125 cwt 150 lb cu ft 26
	OU2236 - _ - _	36" overhead storage unit two hinged doors two wire management grommets	16.5	36	42.5	class 125 cwt 115 lb cu ft 19
	OUF2284 - _ - _ - _	84" overhead storage unit five hinged doors with framed door "inserts" three wire management grommets	16.5	83.75	42.5	class 125 cwt 205 lb cu ft 40
	OUF2272 - _ - _ - _	72" overhead storage unit four hinged doors with framed door "inserts" three wire management grommets	16.5	72	42.5	class 125 cwt 205 lb cu ft 40
	OUF2266 - _ - _ - _	66" overhead storage unit four hinged doors with framed door "inserts" three wire management grommets	16.5	66	42.5	class 125 cwt 175 lb cu ft 38

**top material**  
P laminate top  
W veneer top

**modesty option key**  
W= veneer  
L= laminate  
D= durasyn  
C.O.M.  
A= acrilux  
F= fabric  
C= chemcast™

**grade 1** wood, laminate,  
durasyn, c.o.m.  
**grade 2** acrilux (5 unit minimum),  
fabric  
**grade 3** chemcast™

**edge**

**wood top & chassis finish**

**laminate top finish**

**spacer & frame finish**

**6LC-W** light cherry on birch  
**7MC-W** medium cherry on birch  
**8DC-W** dark cherry on birch  
**MB-W** mocha birch on birch  
**NB-W** natural birch on birch  
**CB-W** cherry birch on birch  
**2ML-W** natural maple on birch  
**3ML-W** light maple on birch  
**4ML-W** medium maple on birch  
**5ML-W** cherry maple on birch

**6LC-P** light cherry on birch  
**7MC-P** medium cherry on birch  
**8DC-P** dark cherry on birch  
**NB-P** natural on birch  
**MB-P** mocha on birch  
**CB-P** cherry on birch  
**2ML-P** natural maple on birch  
**3ML-P** light maple on birch  
**4ML-P** medium maple on birch  
**5ML-P** cherry maple on birch  
**EW-P** eggshell white (EW Durasyn on chassis)

**B** black  
**EW** eggshell white  
**S** silver

**durasyn**  
modesty  
grade 1

**chemcast™**  
modesty  
grade 3

**INSERTS**  
BP black pearl  
BL black  
CH chinchilla  
CT cactus  
EW eggshell white  
FG fog  
NB natural beige  
NG northsea gray  
PE pearl  
RK rock  
SD sand  
ST sunset  
TW tumbleweed

**2025** black  
**2069** blue  
**2247** white  
**2370** bronze  
**P-95** clear

**pulls** all brio units ship standard with (square) pulls  
optional (twisted) pulls are available for no  
upcharge - specify (OP) for optional pull

for **tackboard options**, see pages 486-487  
for standard fabrics available on tackboards,  
see page 472





veneer top grade 1 insert		veneer top grade 2 insert		veneer top grade 3 insert		laminate top grade 1 insert		laminate top grade 2 insert		laminate top grade 3 insert	
list pricing zone 1	zone 2	list pricing zone 1	zone 2	list pricing zone 1	zone 2	list pricing zone 1	zone 2	list pricing zone 1	zone 2	list pricing zone 1	zone 2
2,411	2,604										
2,087	2,253										
1,717	1,853										
3,559	3,843	3,655	3,939	4,036	4,321						
2,766	2,989	2,842	3,070	3,145	3,396						
2,570	2,776	2,638	2,850	2,929	3,164						

laminat	INSERTS	veneer	INSERTS	fabric	INSERTS	momentum	INSERTS
modesty grade 1	NB-P natural birch on birch CB-P cherry birch on birch 2ML-P natural maple on birch 3ML-P light maple on birch 4ML-P medium maple on birch 5ML-P cherry on maple on birch 6LC-P light cherry on birch 7MC-P medium cherry on birch 8DC-P dark cherry on birch 3L-P saddle on walnut 4L-P dark mahogany on walnut 25B-P ebony on walnut 25M-P mahogany on walnut MB-P mocha on birch BA black ashwood BB bethany beige CF copper fusion CL chili CM cardamom fiber CN cinnamon CO coriander fiber CU curacao fiber EW eggshell white GS graphite specktrum GV galvan NV negotiating in geneva NV-G negotiating in geneva gloss OS olive serenity RA rock of ages SU sugar fiber TY thyme fiber WH wheat fiber	modesty grade 1	NB-W natural birch on birch CB-W cherry birch on birch 6LC-W light cherry on birch 7MC-W medium cherry on birch 8DC-W dark cherry on birch MB-W mocha birch on birch 2ML-W natural maple on birch 3ML-W light maple on birch 4ML-W medium maple on birch 5ML-W cherry on birch 1NC-W natural cherry on cherry 2HC-W honey cherry on cherry 9BC-W burgundy cherry on cherry 88M-W mahogany on cherry 2KL-W sepia on walnut 3L-W saddle on walnut 4L-W dark mahogany on walnut 25C-W cherry on walnut 25M-W mahogany on walnut 25B-W ebony on walnut EW-W eggshell white on birch 2ML-W natural maple on birch 3ML-W light maple on birch 4ML-W medium maple on birch 5ML-W cherry maple on birch	modesty grade 2	322-001 rouge 322-009 copper 322-007 bronze 322-013 limelight 322-004 denim 322-000 taupe 323-001 rosewood 323-009 russet 323-019 amber 323-013 limelight 323-004 indigo 323-000 bronze 332-001 pomegranate 334-009 copper 334-007 moonbeam 334-013 limelight 334-004 cobalt 334-000 mocha 302-001 paprika 302-009 copper 302-002 bamboo 302-023 willow 302-014 admiral 302-000 chocolate 316-009 copper 316-019 red clay 316-008 plum 316-003 feldspar 316-024 turquoise 316-004 sapphire 316-010 taupe 316-006 smoke	momentum axis	09102740 paprika 09102773 summer 09102718 grove 09102707 denim 09102729 noir 09102751 truffie 09097955 ascot 09097966 coin 09098021 trellis 09097977 imperial 09098010 shadow 09097999 mocha 09067502 garnet 09067481 amethyst 09067497 eco 09067529 sapphire 09067518 jet 09067540 steel 09067486 bayou 09067525 myth 09067492 bottle 09067532 sodalite 09067512 iron 09067545 system

## F2272-6B-W-B-F

series - dimensions & unit identification (type) - **top/chassis finish** - **top material** - **spacer/frame finish** - **modesty**  
 modesty choice - select grade and insert description of material  
**no spacers on OU units - overhead units do not have an option of wood or laminate tops**

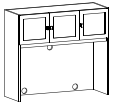
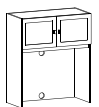
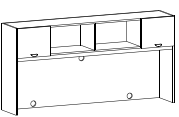
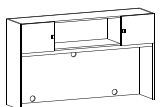
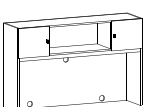
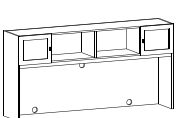
	model number	description	d	w	h	freight
	OUF2248 - _ - _ - _	48" overhead storage unit three hinged doors with framed door "inserts" three wire management grommets	16.5	48	42.5	class 125 cwt 150 lb cu ft 29
	OUF2236 - _ - _ - _	36" overhead storage unit two hinged doors with framed door "inserts" two wire management grommets	16.5	36	42.5	class 125 cwt 150 lb cu ft 26
	OD2284 - _ - _	84" overhead storage unit open center, one hinged door on each end three wire management grommets	16.5	83.75	42.5	class 125 cwt 195 lb cu ft 40
	OD2272 - _ - _	72" overhead storage unit open center, one hinged door on each end three wire management grommets	16.5	72	42.5	class 125 cwt 195 lb cu ft 40
	OD2266 - _ - _	66" overhead storage unit open center, one hinged door on each end three wire management grommets	16.5	66	42.5	class 125 cwt 165 lb cu ft 38
	ODF2284 - _ - _ - _	84" overhead storage unit with framed door "inserts" open center, one hinged door on each end three wire management grommets	16.5	83.75	42.5	class 125 cwt 195 lb cu ft 40

**top material**

**P** laminate top  
**W** veneer top

**modesty option key**

**W**= veneer  
**L**= laminate  
**D**= durasyn  
**C.O.M.**  
**A**= acrilux  
**F**= fabric  
**C**= chemcast™

**grade 1**

wood, laminate, durasyn, c.o.m.

**grade 2**

acrilux (5 unit minimum), fabric

**grade 3**

chemcast™

**edge**



**wood top & chassis finish**

**6LC-W** light cherry on birch  
**7MC-W** medium cherry on birch  
**8DC-W** dark cherry on birch  
**MB-W** mocha birch on birch  
**NB-W** natural birch on birch  
**CB-W** cherry birch on birch  
**2ML-W** natural maple on birch  
**3ML-W** light maple on birch  
**4ML-W** medium maple on birch  
**5ML-W** cherry maple on birch

**laminate top finish**

**6LC-P** light cherry on birch  
**7MC-P** medium cherry on birch  
**8DC-P** dark cherry on birch  
**NB-P** natural on birch  
**MB-P** mocha on birch  
**CB-P** cherry on birch  
**2ML-P** natural maple on birch  
**3ML-P** light maple on birch  
**4ML-P** medium maple on birch  
**5ML-P** cherry maple on birch  
**EW-P** eggshell white (EW Durasyn on chassis)

**spacer & frame finish**

**B** black  
**EW** eggshell white  
**S** silver

**durasyn**  
modesty grade 1

**chemcast™**  
modesty grade 3

**INSERTS**  
**BP** black pearl  
**BL** black  
**CH** chinchilla  
**CT** cactus  
**EW** eggshell white  
**FG** fog  
**NB** natural beige  
**NG** northsea gray  
**PE** pearl  
**RK** rock  
**SD** sand  
**ST** sunset  
**TW** tumbleweed

**2025** black  
**2069** blue  
**2247** white  
**2370** bronze  
**P-95** clear

**pulls**

all brio units ship standard with (square) pulls  
optional (twisted) pulls are available for no upcharge - specify (OP) for optional pull

for **tackboard options**, see pages 486-487  
for standard fabrics available on tackboards, see page 472

brío

| 2200 series

| wood top, veneer chassis, veneer drawer fronts

| laminate top, veneer chassis, veneer drawer fronts



veneer top grade 1 insert		veneer top grade 2 insert		veneer top grade 3 insert		laminate top grade 1 insert		laminate top grade 2 insert		laminate top grade 3 insert	
list pricing zone 1	zone 2	list pricing zone 1	zone 2	list pricing zone 1	zone 2	list pricing zone 1	zone 2	list pricing zone 1	zone 2	list pricing zone 1	zone 2
2,454	2,650	2,509	2,710	2,804	3,028						
1,786	1,930	1,830	1,978	2,016	2,176						
3,257	3,518										
2,505	2,706										
2,317	2,503										
3,361	3,629	3,456	3,724	3,838	4,107						

laminat	INSERTS	veneer	INSERTS	fabric	INSERTS	momentum	INSERTS
modesty grade 1	<b>NB-P</b> natural birch on birch <b>CB-P</b> cherry birch on birch <b>2ML-P</b> natural maple on birch <b>3ML-P</b> light maple on birch <b>4ML-P</b> medium maple on birch <b>5ML-P</b> cherry on maple on birch <b>6LC-P</b> light cherry on birch <b>7MC-P</b> medium cherry on birch <b>8DC-P</b> dark cherry on birch <b>3L-P</b> saddle on walnut <b>4L-P</b> dark mahogany on walnut <b>25B-P</b> ebony on walnut <b>25M-P</b> mahogany on walnut <b>MB-P</b> mocha on birch <b>BA</b> black ashwood <b>BB</b> bethany beige <b>CF</b> copper fusion <b>CL</b> chili <b>CM</b> cardamom fiber <b>CN</b> cinnamon <b>CO</b> coriander fiber <b>CU</b> curacao fiber <b>EW</b> eggshell white <b>GS</b> graphite specktrum <b>GV</b> galvan <b>NV</b> negotiating in geneva <b>NV-G</b> negotiating in geneva gloss <b>OS</b> olive serenity <b>RA</b> rock of ages <b>SU</b> sugar fiber <b>TY</b> thyme fiber <b>WH</b> wheat fiber	<b>NB-W</b> natural birch on birch <b>CB-W</b> cherry birch on birch <b>6LC-W</b> light cherry on birch <b>7MC-W</b> medium cherry on birch <b>8DC-W</b> dark cherry on birch <b>MB-W</b> mocha birch on birch <b>2ML-W</b> natural maple on birch <b>3ML-W</b> light maple on birch <b>4ML-W</b> medium maple on birch <b>5ML-W</b> cherry on birch <b>1NC-W</b> natural cherry on cherry <b>2HC-W</b> honey cherry on cherry <b>9BC-W</b> burgundy cherry on cherry <b>88M-W</b> mahogany on cherry <b>2KL-W</b> sepia on walnut <b>3L-W</b> saddle on walnut <b>4L-W</b> dark mahogany on walnut <b>25C-W</b> cherry on walnut <b>25M-W</b> mahogany on walnut <b>25B-W</b> ebony on walnut <b>EW-W</b> eggshell white on birch <b>2ML-W</b> natural maple on birch <b>3ML-W</b> light maple on birch <b>4ML-W</b> medium maple on birch <b>5ML-W</b> cherry maple on birch	<b>modesty</b> grade 2 <b>mayer</b> catalyst <b>mayer</b> equation <b>mayer</b> lunar <b>mayer</b> paramount <b>mayer</b> element	<b>322-001</b> rouge <b>322-009</b> copper <b>322-007</b> bronze <b>322-013</b> limelight <b>322-004</b> denim <b>322-000</b> taupe <b>323-001</b> rosewood <b>323-009</b> russet <b>323-019</b> amber <b>323-013</b> limelight <b>323-004</b> indigo <b>323-000</b> bronze <b>332-001</b> pomegranate <b>334-009</b> copper <b>334-007</b> moonbeam <b>334-013</b> limelight <b>334-004</b> cobalt <b>334-000</b> mocha <b>302-001</b> paprika <b>302-009</b> copper <b>302-002</b> bamboo <b>302-023</b> willow <b>302-014</b> admiral <b>302-000</b> chocolate <b>316-009</b> copper <b>316-019</b> red clay <b>316-008</b> plum <b>316-003</b> feldspar <b>316-024</b> turquoise <b>316-004</b> sapphire <b>316-010</b> taupe <b>316-006</b> smoke	<b>axis</b> <b>momentum</b> russo <b>momentum</b> origin	<b>09102740</b> paprika <b>09102773</b> summer <b>09102718</b> grove <b>09102707</b> denim <b>09102729</b> noir <b>09102751</b> truffie <b>09097955</b> ascot <b>09097966</b> coin <b>09098021</b> trellis <b>09097977</b> imperial <b>09098010</b> shadow <b>09097999</b> mocha <b>09067502</b> garnet <b>09067481</b> amethyst <b>09067497</b> eco <b>09067529</b> sapphire <b>09067518</b> jet <b>09067540</b> steel <b>09067486</b> bayou <b>09067525</b> myth <b>09067492</b> bottle <b>09067532</b> sodalite <b>09067512</b> iron <b>09067545</b> system	



## F2272-6B-W-B-F

series - dimensions & unit identification (type) - **top/chassis finish** - **top material** - **spacer/frame finish** - **modesty**  
 modesty choice - select grade and insert description of material  
**no spacers on OU units - overhead units do not have an option of wood or laminate tops**

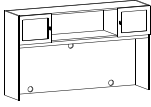
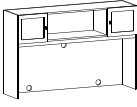
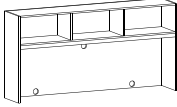
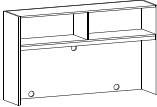
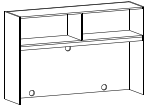
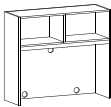
	model number	description	d	w	h	freight
	ODF2272 - _ - _ - _	72" overhead storage unit with framed door "inserts" open center, one hinged door on each side three wire management grommets	16.5	72	42.5	class 125 cwt 195 lb cu ft 40
	ODF2266 - _ - _ - _	66" overhead storage unit with framed door "inserts" open center, one hinged door on each side three wire management grommets	16.5	66	42.5	class 125 cwt 165 lb cu ft 38
	OO2284 - _ - _	84" open overhead storage unit three wire management grommets	16.5	83.75	42.5	class 125 cwt 185 lb cu ft 40
	OO2272 - _ - _	72" open overhead storage unit three wire management grommets	16.5	72	42.5	class 125 cwt 185 lb cu ft 40
	OO2266 - _ - _	66" open overhead storage unit three wire management grommets	16.5	66	42.5	class 125 cwt 155 lb cu ft 38
	OO2248 - _ - _	48" open overhead storage unit three wire management grommets	16.5	48	42.5	class 125 cwt 145 lb cu ft 26

**top material**  
**P** laminate top  
**W** veneer top

**modesty option key**  
**W**= veneer  
**L**= laminate  
**D**= durasyn  
**C.O.M.**  
**A**= acrilux  
**F**= fabric  
**C**= chemcast™

**grade 1** wood, laminate,  
 durasyn, c.o.m.  
**grade 2** acrilux (5 unit minimum),  
 fabric  
**grade 3** chemcast™

**edge**

**G**

**wood top & chassis finish**

**laminate top finish**

**spacer & frame finish**

**6LC-W** light cherry on birch  
**7MC-W** medium cherry on birch  
**8DC-W** dark cherry on birch  
**MB-W** mocha birch on birch  
**NB-W** natural birch on birch  
**CB-W** cherry birch on birch  
**2ML-W** natural maple on birch  
**3ML-W** light maple on birch  
**4ML-W** medium maple on birch  
**5ML-W** cherry maple on birch

**6LC-P** light cherry on birch  
**7MC-P** medium cherry on birch  
**8DC-P** dark cherry on birch  
**NB-P** natural on birch  
**MB-P** mocha on birch  
**CB-P** cherry on birch  
**2ML-P** natural maple on birch  
**3ML-P** light maple on birch  
**4ML-P** medium maple on birch  
**5ML-P** cherry maple on birch  
**EW-P** eggshell white (EW Durasyn on chassis)

**B** black  
**EW** eggshell white  
**S** silver

**pulls** all brio units ship standard with (square) pulls optional (twisted) pulls are available for no upcharge - specify (OP) for optional pull

**durasyn**  
 modesty grade 1

**chemcast™**  
 modesty grade 3

**INSERTS**  
**BP** black pearl  
**BL** black  
**CH** chinchilla  
**CT** cactus  
**EW** eggshell white  
**FG** fog  
**NB** natural beige  
**NG** northsea gray  
**PE** pearl  
**RK** rock  
**SD** sand  
**ST** sunset  
**TW** tumbleweed

**2025** black  
**2069** blue  
**2247** white  
**2370** bronze  
**P-95** clear

for **tackboard options**, see pages 486-487 for standard fabrics available on tackboards, see page 472

brío

| 2200 series





| wood top, veneer chassis, veneer drawer fronts

| laminate top, veneer chassis, veneer drawer fronts

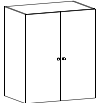
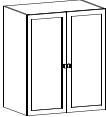

veneer top grade 1 insert		veneer top grade 2 insert		veneer top grade 3 insert		laminate top grade 1 insert		laminate top grade 2 insert		laminate top grade 3 insert	
list pricing zone 1	zone 2	list pricing zone 1	zone 2	list pricing zone 1	zone 2	list pricing zone 1	zone 2	list pricing zone 1	zone 2	list pricing zone 1	zone 2
2,591	2,797	2,629	2,839	2,781	3,003						
2,399	2,592	2,481	2,680	2,625	2,837						
3,162	3,415										
2,389	2,605										
2,203	2,402										
1,669	1,801										

laminat	INSERTS	veneer	INSERTS	fabric	INSERTS	momentum	INSERTS
modesty grade 1	<b>NB-P</b> natural birch on birch <b>CB-P</b> cherry birch on birch <b>2ML-P</b> natural maple on birch <b>3ML-P</b> light maple on birch <b>4ML-P</b> medium maple on birch <b>5ML-P</b> cherry on maple on birch <b>6LC-P</b> light cherry on birch <b>7MC-P</b> medium cherry on birch <b>8DC-P</b> dark cherry on birch <b>3L-P</b> saddle on walnut <b>4L-P</b> dark mahogany on walnut <b>25B-P</b> ebony on walnut <b>25M-P</b> mahogany on walnut <b>MB-P</b> mocha on birch <b>BA</b> black ashwood <b>BB</b> bethany beige <b>CF</b> copper fusion <b>CL</b> chili <b>CM</b> cardamom fiber <b>CN</b> cinnamon <b>CO</b> coriander fiber <b>CU</b> curacao fiber <b>EW</b> eggshell white <b>GS</b> graphite specktrum <b>GV</b> galvan <b>NV</b> negotiating in geneva <b>NV-G</b> negotiating in geneva gloss <b>OS</b> olive serenity <b>RA</b> rock of ages <b>SU</b> sugar fiber <b>TY</b> thyme fiber <b>WH</b> wheat fiber	<b>NB-W</b> natural birch on birch <b>CB-W</b> cherry birch on birch <b>6LC-W</b> light cherry on birch <b>7MC-W</b> medium cherry on birch <b>8DC-W</b> dark cherry on birch <b>MB-W</b> mocha birch on birch <b>2ML-W</b> natural maple on birch <b>3ML-W</b> light maple on birch <b>4ML-W</b> medium maple on birch <b>5ML-W</b> cherry on birch <b>1NC-W</b> natural cherry on cherry <b>2HC-W</b> honey cherry on cherry <b>9BC-W</b> burgundy cherry on cherry <b>88M-W</b> mahogany on cherry <b>2KL-W</b> sepia on walnut <b>3L-W</b> saddle on walnut <b>4L-W</b> dark mahogany on walnut <b>25C-W</b> cherry on walnut <b>25M-W</b> mahogany on walnut <b>25B-W</b> ebony on walnut <b>EW-W</b> eggshell white on birch <b>2ML-W</b> natural maple on birch <b>3ML-W</b> light maple on birch <b>4ML-W</b> medium maple on birch <b>5ML-W</b> cherry maple on birch	<b>modesty</b> grade 2 <b>mayer</b> catalyst <b>mayer</b> equation <b>mayer</b> lunar <b>mayer</b> paramount <b>mayer</b> element	<b>322-001</b> rouge <b>322-009</b> copper <b>322-007</b> bronze <b>322-013</b> limelight <b>322-004</b> denim <b>322-000</b> taupe <b>323-001</b> rosewood <b>323-009</b> russet <b>323-019</b> amber <b>323-013</b> limelight <b>323-004</b> indigo <b>323-000</b> bronze <b>332-001</b> pomegranate <b>334-009</b> copper <b>334-007</b> moonbeam <b>334-013</b> limelight <b>334-004</b> cobalt <b>334-000</b> mocha <b>302-001</b> paprika <b>302-009</b> copper <b>302-002</b> bamboo <b>302-023</b> willow <b>302-014</b> admiral <b>302-000</b> chocolate <b>316-009</b> copper <b>316-019</b> red clay <b>316-008</b> plum <b>316-003</b> feldspar <b>316-024</b> turquoise <b>316-004</b> sapphire <b>316-010</b> taupe <b>316-006</b> smoke	<b>axis</b> <b>momentum</b> russo <b>momentum</b> origin	<b>09102740</b> paprika <b>09102773</b> summer <b>09102718</b> grove <b>09102707</b> denim <b>09102729</b> noir <b>09102751</b> truffie <b>09097955</b> ascot <b>09097966</b> coin <b>09098021</b> trellis <b>09097977</b> imperial <b>09098010</b> shadow <b>09097999</b> mocha <b>09067502</b> garnet <b>09067481</b> amethyst <b>09067497</b> eco <b>09067529</b> sapphire <b>09067518</b> jet <b>09067540</b> steel <b>09067486</b> bayou <b>09067525</b> myth <b>09067492</b> bottle <b>09067532</b> sodalite <b>09067512</b> iron <b>09067545</b> system	

	model number	description	d	w	h	freight
	OO2236 - _ - _	36" open overhead storage unit three wire management grommets	16.5	36	42.5	class 125 cwt 145 lb cu ft 26
	HW2236-42 - _ - _	hutch with two wood doors 2 adjustable shelves  <i>SOLID WOOD SHELVES (EACH) \$28</i> <i>EXTRA SHELF (EACH) \$92</i>	24	36	42.5	class 125 cwt 95 lb cu ft 20
	HWF2236-42 - _ - _ - _ - _	hutch with two framed doors with "inserts" 2 adjustable shelves  <i>SOLID WOOD SHELVES (EACH) \$28</i> <i>EXTRA SHELF (EACH) \$92</i>	24	36	42.5	class 125 cwt 95 lb cu ft 20
	2FD2236 - _ - _ - _	20" deep lateral file two drawer standard anti-tip locking mechanism	20	36	29	class 125 cwt 175 lb cu ft 17
	2FD223624 - _ - _ - _	24" deep two drawer lateral file pedestal standard anti-tip locking mechanism	24	36	29	class 125 cwt 158 lb cu ft 19
	5D223624R - _ - _ - _	24" deep multi-file pedestal file/file and box/box file	24	36	29	class 125 cwt 160 lb cu ft 18

<b>top material</b>	<b>P</b> laminate top <b>W</b> veneer top	<b>wood top &amp; chassis finish</b>	<b>6LC-W</b> light cherry on birch <b>7MC-W</b> medium cherry on birch <b>8DC-W</b> dark cherry on birch <b>MB-W</b> mocha birch on birch <b>NB-W</b> natural birch on birch <b>CB-W</b> cherry birch on birch <b>2ML-W</b> natural maple on birch <b>3ML-W</b> light maple on birch <b>4ML-W</b> medium maple on birch <b>5ML-W</b> cherry maple on birch	<b>durasyn</b> modesty grade 1	<b>BP</b> black pearl <b>BL</b> black <b>CH</b> chinchilla <b>CT</b> cactus <b>EW</b> eggshell white <b>FG</b> fog <b>NB</b> natural beige <b>NG</b> northsea gray <b>PE</b> pearl <b>RK</b> rock <b>SD</b> sand <b>ST</b> sunset <b>TW</b> tumbleweed
<b>modesty option key</b>	<b>W</b> = veneer <b>L</b> = laminate <b>D</b> = durasyn <b>C.O.M.</b> <b>A</b> = acrilux <b>F</b> = fabric <b>C</b> = chemcast™	<b>laminate top finish</b>	<b>6LC-P</b> light cherry on birch <b>7MC-P</b> medium cherry on birch <b>8DC-P</b> dark cherry on birch <b>NB-P</b> natural on birch <b>MB-P</b> mocha on birch <b>CB-P</b> cherry on birch <b>2ML-P</b> natural maple on birch <b>3ML-P</b> light maple on birch <b>4ML-P</b> medium maple on birch <b>5ML-P</b> cherry maple on birch <b>EW-P</b> eggshell white (EW Durasyn on chassis)	<b>chemcast™</b> modesty grade 3	<b>2025</b> black <b>2069</b> blue <b>2247</b> white <b>2370</b> bronze <b>P-95</b> clear
<b>grade 1</b>	wood, laminate, durasyn, c.o.m.	<b>spacer &amp; frame finish</b>	<b>B</b> black <b>EW</b> eggshell white <b>S</b> silver		
<b>grade 2</b>	acrilux (5 unit minimum), fabric				
<b>grade 3</b>	chemcast™				
<b>edge</b>	<b>G</b>	<b>pulls</b>	all brio units ship standard with (square) pulls optional (twisted) pulls are available for no upcharge - specify (OP) for optional pull		

brío

| 2200 series







| wood top, veneer chassis, veneer drawer fronts

| laminate top, veneer chassis, veneer drawer fronts

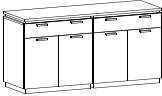

veneer top grade 1 insert		veneer top grade 2 insert		veneer top grade 3 insert		laminate top grade 1 insert		laminate top grade 2 insert		laminate top grade 3 insert	
list pricing zone 1	zone 2	list pricing zone 1	zone 2	list pricing zone 1	zone 2	list pricing zone 1	zone 2	list pricing zone 1	zone 2	list pricing zone 1	zone 2
1,438	1,553										
1,833	1,980										
1,992	2,151	2,060	2,226	2,352	2,541						
1,780	1,922					1,641	1,773				
2,118	2,286					1,979	2,137				
3,012	3,253					2,873	3,104				

laminat	INSERTS	veneer	INSERTS	fabric	INSERTS	momentum	INSERTS
modesty grade 1	NB-P natural birch on birch CB-P cherry birch on birch 2ML-P natural maple on birch 3ML-P light maple on birch 4ML-P medium maple on birch 5ML-P cherry on maple on birch 6LC-P light cherry on birch 7MC-P medium cherry on birch 8DC-P dark cherry on birch 3L-P saddle on walnut 4L-P dark mahogany on walnut 25B-P ebony on walnut 25M-P mahogany on walnut MB-P mocha on birch BA black ashwood BB bethany beige CF copper fusion CL chili CM cardamom fiber CN cinnamon CO coriander fiber CU curacao fiber EW eggshell white GS graphite specktrum GV galvan NV negotiating in geneva NV-G negotiating in geneva gloss OS olive serenity RA rock of ages SU sugar fiber TY thyme fiber WH wheat fiber	modesty grade 1	NB-W natural birch on birch CB-W cherry birch on birch 6LC-W light cherry on birch 7MC-W medium cherry on birch 8DC-W dark cherry on birch MB-W mocha birch on birch 2ML-W natural maple on birch 3ML-W light maple on birch 4ML-W medium maple on birch 5ML-W cherry on birch 1NC-W natural cherry on cherry 2HC-W honey cherry on cherry 9BC-W burgundy cherry on cherry 88M-W mahogany on cherry 2KL-W sepia on walnut 3L-W saddle on walnut 4L-W dark mahogany on walnut 25C-W cherry on walnut 25M-W mahogany on walnut 25B-W ebony on walnut EW-W eggshell white on birch 2ML-W natural maple on birch 3ML-W light maple on birch 4ML-W medium maple on birch 5ML-W cherry maple on birch	modesty grade 2	322-001 rouge 322-009 copper 322-007 bronze 322-013 limelight 322-004 denim 322-000 taupe 323-001 rosewood 323-009 russet 323-019 amber 323-013 limelight 323-004 indigo 323-000 bronze 332-001 pomegranate 334-009 copper 334-007 moonbeam 334-013 limelight 334-004 cobalt 334-000 mocha 302-001 paprika 302-009 copper 302-002 bamboo 302-023 willow 302-014 admiral 302-000 chocolate 316-009 copper 316-019 red clay 316-008 plum 316-003 feldspar 316-024 turquoise 316-004 sapphire 316-010 taupe 316-006 smoke	momentum axis	09102740 paprika 09102773 summer 09102718 grove 09102707 denim 09102729 noir 09102751 truffie 09097955 ascot 09097966 coin 09098021 trellis 09097977 imperial 09098010 shadow 09097999 mocha 09067502 garnet 09067481 amethyst 09067497 eco 09067529 sapphire 09067518 jet 09067540 steel 09067486 bayou 09067525 myth 09067492 bottle 09067532 sodalite 09067512 iron 09067545 system

	model number	description	d	w	h	freight
	5D223624L - _ - _ - _	24" deep multi-file pedestal box/box/file and file/file	24	36	29	class 125 cwt 160 lb cu ft 18
	2F221824 - _ - _ - _	24" deep file/file pedestal	24	18	29	class 125 cwt 100 lb cu ft 9
	MP222F - _ - _	mobile file/file pedestal black organizer top will fit under 29" surface	18.9	15.6	27.3	class 125 cwt 80 lb cu ft 7
	MP223D - _ - _	mobile box/box/file pedestal black organizer top will fit under 29" surface	18.9	15.6	27.3	class 125 cwt 80 lb cu ft 7
	4HW2272D-36 - _ - _	serving height credenza two sets of hinged doors one adjustable shelf on each side, two drawers above	20	72	36	class 125 cwt 405 lb cu ft 37
	3FD2236 - _ - _ - _	20" deep lateral file three drawer standard anti-tip locking mechanism	20	36	72	class 125 cwt 285 lb cu ft 42

**top material**  
P laminate top  
W veneer top

**modesty option key**  
W= veneer  
L= laminate  
D= durasyn  
C.O.M.  
A= acrilux  
F= fabric  
C= chemcast™

**grade 1** wood, laminate,  
durasyn, c.o.m.  
**grade 2** acrilux (5 unit minimum),  
fabric  
**grade 3** chemcast™

**edge**

**wood top & chassis finish**

**laminate top finish**

**spacer & frame finish**

**6LC-W** light cherry on birch  
**7MC-W** medium cherry on birch  
**8DC-W** dark cherry on birch  
**MB-W** mocha birch on birch  
**NB-W** natural birch on birch  
**CB-W** cherry birch on birch  
**2ML-W** natural maple on birch  
**3ML-W** light maple on birch  
**4ML-W** medium maple on birch  
**5ML-W** cherry maple on birch

**6LC-P** light cherry on birch  
**7MC-P** medium cherry on birch  
**8DC-P** dark cherry on birch  
**NB-P** natural on birch  
**MB-P** mocha on birch  
**CB-P** cherry on birch  
**2ML-P** natural maple on birch  
**3ML-P** light maple on birch  
**4ML-P** medium maple on birch  
**5ML-P** cherry maple on birch  
**EW-P** eggshell white (EW Durasyn on chassis)

**B** black  
**EW** eggshell white  
**S** silver

**pulls** all brio units ship standard with (square) pulls optional (twisted) pulls are available for no upcharge - specify (OP) for optional pull

**durasyn**  
modesty grade 1

**chemcast™**  
modesty grade 3

**INSERTS**  
**BP** black pearl  
**BL** black  
**CH** chinchilla  
**CT** cactus  
**EW** eggshell white  
**FG** fog  
**NB** natural beige  
**NG** northsea gray  
**PE** pearl  
**RK** rock  
**SD** sand  
**ST** sunset  
**TW** tumbleweed

**2025** black  
**2069** blue  
**2247** white  
**2370** bronze  
**P-95** clear



brío

| 2200 series

| wood top, veneer chassis, veneer drawer fronts

| laminate top, veneer chassis, veneer drawer fronts





veneer top grade 1 insert		veneer top grade 2 insert		veneer top grade 3 insert		laminate top grade 1 insert		laminate top grade 2 insert		laminate top grade 3 insert	
list pricing zone 1	zone 2	list pricing zone 1	zone 2	list pricing zone 1	zone 2	list pricing zone 1	zone 2	list pricing zone 1	zone 2	list pricing zone 1	zone 2
3,012	3,253					2,873	3,104				
1,451	1,567					1,435	1,549				
1,217	1,315										
1,232	1,331										
5,456	5,881					5,066	5,471				
2,458	2,655					2,265	2,447				

laminat	INSERTS	veneer	INSERTS	fabric	INSERTS	momentum	INSERTS
modesty grade 1	NB-P natural birch on birch CB-P cherry birch on birch 2ML-P natural maple on birch 3ML-P light maple on birch 4ML-P medium maple on birch 5ML-P cherry on maple on birch 6LC-P light cherry on birch 7MC-P medium cherry on birch 8DC-P dark cherry on birch 3L-P saddle on walnut 4L-P dark mahogany on walnut 25B-P ebony on walnut 25M-P mahogany on walnut MB-P mocha on birch BA black ashwood BB bethany beige CF copper fusion CL chili CM cardamom fiber CN cinnamon CO coriander fiber CU curacao fiber EW eggshell white GS graphite specktrum GV galvan NV negotiating in geneva NV-G negotiating in geneva gloss OS olive serenity RA rock of ages SU sugar fiber TY thyme fiber WH wheat fiber	modesty grade 1	NB-W natural birch on birch CB-W cherry birch on birch 6LC-W light cherry on birch 7MC-W medium cherry on birch 8DC-W dark cherry on birch MB-W mocha birch on birch 2ML-W natural maple on birch 3ML-W light maple on birch 4ML-W medium maple on birch 5ML-W cherry on birch 1NC-W natural cherry on cherry 2HC-W honey cherry on cherry 9BC-W burgundy cherry on cherry 88M-W mahogany on cherry 2KL-W sepia on walnut 3L-W saddle on walnut 4L-W dark mahogany on walnut 25C-W cherry on walnut 25M-W mahogany on walnut 25B-W ebony on walnut EW-W eggshell white on birch 2ML-W natural maple on birch 3ML-W light maple on birch 4ML-W medium maple on birch 5ML-W cherry maple on birch	modesty grade 2	322-001 rouge 322-009 copper 322-007 bronze 322-013 limelight 322-004 denim 322-000 taupe 323-001 rosewood 323-009 russet 323-019 amber 323-013 limelight 323-004 indigo 323-000 bronze 332-001 pomegranate 334-009 copper 334-007 moonbeam 334-013 limelight 334-004 cobalt 334-000 mocha 302-001 paprika 302-009 copper 302-002 bamboo 302-023 willow 302-014 admiral 302-000 chocolate 316-009 copper 316-019 red clay 316-008 plum 316-003 feldspar 316-024 turquoise 316-004 sapphire 316-010 taupe 316-006 smoke	momentum axis	09102740 paprika 09102773 summer 09102718 grove 09102707 denim 09102729 noir 09102751 truffie 09097955 ascot 09097966 coin 09098021 trellis 09097977 imperial 09098010 shadow 09097999 mocha 09067502 garnet 09067481 amethyst 09067497 eco 09067529 sapphire 09067518 jet 09067540 steel 09067486 bayou 09067525 myth 09067492 bottle 09067532 sodalite 09067512 iron 09067545 system

## F2272-6B-W-B-F

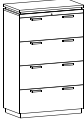
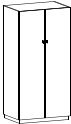
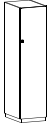
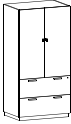
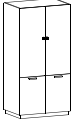
series - dimensions & unit identification (type) - top/chassis finish - top material - spacer/frame finish - modesty  
modesty choice - select grade and insert description of material

	model number	description	d	w	h	freight
	4FD2236 - _ - _ - _	20" deep lateral file four drawer standard anti-tip locking mechanism	20	36	56	class 125 cwt 265 lb cu ft 29
	CT2272-WD - _ - _ - _	case tower wardrobe two hinged doors right side coat storage left side three adjustable shelves storage shelf above includes 1 fixed shelf <i>SOLID WOOD SHELVES (EACH) \$28</i> <i>EXTRA SHELF (EACH) \$92</i>	24	36	72	class 125 cwt 285 lb cu ft 42
	CTWD2272R-18 - _ - _ - _ CTWD2272L-18 - _ - _ - _	case tower (R) hinge on right/knob on left (L) hinge on left/knob on right  <i>SOLID WOOD SHELVES (EACH) \$28</i> <i>EXTRA SHELF (EACH) \$92</i>	24	18	72	class 125 cwt 200 lb cu ft 29
	CT2272-AV2F - _ - _ - _	case tower AV access hinged doors above lateral file below	24	36	72	class 125 cwt 310 lb cu ft 42
	CT2272-AVHW - _ - _ - _	case tower with AV access hinged doors above hinged doors below with 1 adjustable shelf <i>SOLID WOOD SHELVES (EACH) \$28</i> <i>EXTRA SHELF (EACH) \$92</i>	24	36	72	class 125 cwt 310 lb cu ft 42
	HD2236 - _ - _ - _	double hinged door 20" cabinet adjustable shelf  <i>SOLID WOOD SHELVES (EACH) \$28</i> <i>EXTRA SHELF (EACH) \$92</i>	20	36	29	class 125 cwt 175 lb cu ft 17

**top material**

**P** laminate top  
**W** veneer top

**modesty option key**

**W**= veneer  
**L**= laminate  
**D**= durasyn  
**C.O.M.**  
**A**= acrilux  
**F**= fabric  
**C**= chemcast™

**grade 1**

wood, laminate,  
durasyn, c.o.m.

**grade 2**

acrilux (5 unit minimum),  
fabric

**grade 3**

chemcast™

**wood top & chassis finish**

**6LC-W** light cherry on birch  
**7MC-W** medium cherry on birch  
**8DC-W** dark cherry on birch  
**MB-W** mocha birch on birch  
**NB-W** natural birch on birch  
**CB-W** cherry birch on birch  
**2ML-W** natural maple on birch  
**3ML-W** light maple on birch  
**4ML-W** medium maple on birch  
**5ML-W** cherry maple on birch

**laminate top finish**

**6LC-P** light cherry on birch  
**7MC-P** medium cherry on birch  
**8DC-P** dark cherry on birch  
**NB-P** natural on birch  
**MB-P** mocha on birch  
**CB-P** cherry on birch  
**2ML-P** natural maple on birch  
**3ML-P** light maple on birch  
**4ML-P** medium maple on birch  
**5ML-P** cherry maple on birch  
**EW-P** eggshell white (EW Durasyn on chassis)

**spacer & frame finish**

**B** black  
**EW** eggshell white  
**S** silver

**durasyn**  
modesty  
grade 1

**BP** black pearl  
**BL** black  
**CH** chinchilla  
**CT** cactus  
**EW** eggshell white  
**FG** fog  
**NB** natural beige  
**NG** northsea gray  
**PE** pearl  
**RK** rock  
**SD** sand  
**ST** sunset  
**TW** tumbleweed

**chemcast™**  
modesty  
grade 3

**2025** black  
**2069** blue  
**2247** white  
**2370** bronze  
**P-95** clear

**edge**



**pulls**

all brio units ship standard with (square) pulls  
optional (twisted) pulls are available for no  
upcharge - specify (OP) for optional pull

brío

| 2200 series

| wood top, veneer chassis, veneer drawer fronts

| laminate top, veneer chassis, veneer drawer fronts



veneer top grade 1 insert		veneer top grade 2 insert		veneer top grade 3 insert		laminate top grade 1 insert		laminate top grade 2 insert		laminate top grade 3 insert	
list pricing zone 1	zone 2	list pricing zone 1	zone 2	list pricing zone 1	zone 2	list pricing zone 1	zone 2	list pricing zone 1	zone 2	list pricing zone 1	zone 2
3,139	3,390					2,943	3,178				
2,727	2,946										
2,137	2,308										
4,351	4,699										
4,653	5,027										
1,553	1,677					1,414	1,528				

laminat modesty grade 1	INSERTS
NB-P	natural birch on birch
CB-P	cherry birch on birch
2ML-P	natural maple on birch
3ML-P	light maple on birch
4ML-P	medium maple on birch
5ML-P	cherry on maple on birch
6LC-P	light cherry on birch
7MC-P	medium cherry on birch
8DC-P	dark cherry on birch
3L-P	saddle on walnut
4L-P	dark mahogany on walnut
25B-P	ebony on walnut
25M-P	mahogany on walnut
MB-P	mocha on birch
BA	black ashwood
BB	bethany beige
CF	copper fusion
CL	chili
CM	cardamom fiber
CN	cinnamon
CO	coriander fiber
CU	curacao fiber
EW	eggshell white
GS	graphite specktrum
GV	galvan
NV	negotiating in geneva
NV-G	negotiating in geneva gloss
OS	olive serenity
RA	rock of ages
SU	sugar fiber
TY	thyme fiber
WH	wheat fiber

veneer modesty grade 1	INSERTS
NB-W	natural birch on birch
CB-W	cherry birch on birch
6LC-W	light cherry on birch
7MC-W	medium cherry on birch
8DC-W	dark cherry on birch
MB-W	mocha birch on birch
2ML-W	natural maple on birch
3ML-W	light maple on birch
4ML-W	medium maple on birch
5ML-W	cherry on birch
1NC-W	natural cherry on cherry
2HC-W	honey cherry on cherry
9BC-W	burgundy cherry on cherry
88M-W	mahogany on cherry
2KL-W	sepia on walnut
3L-W	saddle on walnut
4L-W	dark mahogany on walnut
25C-W	cherry on walnut
25M-W	mahogany on walnut
25B-W	ebony on walnut
EW-W	eggshell white on birch
2ML-W	natural maple on birch
3ML-W	light maple on birch
4ML-W	medium maple on birch
5ML-W	cherry maple on birch

fabric modesty grade 2	INSERTS
322-001	rouge
322-009	copper
322-007	bronze
322-013	limelight
322-004	denim
322-000	taupe
323-001	rosewood
323-009	russet
323-019	amber
323-013	limelight
323-004	indigo
323-000	bronze
332-001	pomegranate
334-009	copper
334-007	moonbeam
334-013	limelight
334-004	cobalt
334-000	mocha
302-001	paprika
302-009	copper
302-002	bamboo
302-023	willow
302-014	admiral
302-000	chocolate
316-009	copper
316-019	red clay
316-008	plum
316-003	feldspar
316-024	turquoise
316-004	sapphire
316-010	taupe
316-006	smoke

momentum axis	INSERTS
09102740	paprika
09102773	summer
09102718	grove
09102707	denim
09102729	noir
09102751	truffe
09097955	ascot
09097966	coin
09098021	trellis
09097977	imperial
09098010	shadow
09097999	mocha
09067502	garnet
09067481	amethyst
09067497	eco
09067529	sapphire
09067518	jet
09067540	steel
09067486	bayou
09067525	myth
09067492	bottle
09067532	sodalite
09067512	iron
09067545	system



## F2272-6B-W-B-F

series - dimensions & unit identification (type) - top/chassis finish - top material - spacer/frame finish - modesty  
modesty choice - select grade and insert description of material

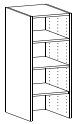
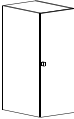
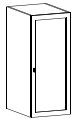
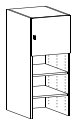
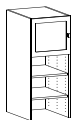
	model number	description	d	w	h	freight
	HD223624 - _ - _ - _	double hinged door 24" cabinet adjustable shelf SOLID WOOD SHELVES (EACH) \$28 EXTRA SHELF (EACH) \$92	24	36	29	class 125 cwt 115 lb cu ft 18
	HO2218 - _ - _ -	open shelf unit 3 adjustable shelves SOLID WOOD SHELVES (EACH) \$28 EXTRA SHELF (EACH) \$92	16	18	42.5	class 125 cwt 60 lb cu ft 10
	HW2218R - _ - _ - HW2218L - _ - _ -	hutch with door (R) hinge on right/knob on left (L) hinge on left/knob on right 2 adjustable shelves SOLID WOOD SHELVES (EACH) \$28 EXTRA SHELF (EACH) \$92	16	18	42.5	class 125 cwt 80 lb cu ft 10
	HWF2218R - _ - _ - - HWF2218L - _ - _ - -	hutch with framed door "inserts" (R) hinge on right/knob on left (L) hinge on left/knob on right 2 adjustable shelves SOLID WOOD SHELVES (EACH) \$28 EXTRA SHELF (EACH) \$92	16	18	42.5	class 125 cwt 80 lb cu ft 10
	HWO2218R - _ - _ - HWO2218L - _ - _ -	hutch with wood door above open below (R) hinge on right/knob on left (L) hinge on left/knob on right 2 adjustable shelves SOLID WOOD SHELVES (EACH) \$28 EXTRA SHELF (EACH) \$92	16	18	42.5	class 125 cwt 70 lb cu ft 10
	HWO2218R - _ - _ - - HWO2218L - _ - _ - -	hutch with framed door "inserts" open below (R)hinge on right/knob on left (L)hinge on left/knob on right 2 adjustable shelves SOLID WOOD SHELVES (EACH) \$28 EXTRA SHELF (EACH) \$92	16	18	42.5	class 125 cwt 70 lb cu ft 10

<b>top material</b>	<b>P</b> laminate top <b>W</b> veneer top	<b>wood top &amp; chassis finish</b>	<b>6LC-W</b> light cherry on birch <b>7MC-W</b> medium cherry on birch <b>8DC-W</b> dark cherry on birch <b>MB-W</b> mocha birch on birch <b>NB-W</b> natural birch on birch <b>CB-W</b> cherry birch on birch <b>2ML-W</b> natural maple on birch <b>3ML-W</b> light maple on birch <b>4ML-W</b> medium maple on birch <b>5ML-W</b> cherry maple on birch	<b>durasyn</b> modesty grade 1	<b>BP</b> black pearl <b>BL</b> black <b>CH</b> chinchilla <b>CT</b> cactus <b>EW</b> eggshell white <b>FG</b> fog <b>NB</b> natural beige <b>NG</b> northsea gray <b>PE</b> pearl <b>RK</b> rock <b>SD</b> sand <b>ST</b> sunset <b>TW</b> tumbleweed
<b>modesty option key</b>	<b>W</b> = veneer <b>L</b> = laminate <b>D</b> = durasyn <b>C.O.M.</b> <b>A</b> = acrilux <b>F</b> = fabric <b>C</b> = chemcast™	<b>laminate top finish</b>	<b>6LC-P</b> light cherry on birch <b>7MC-P</b> medium cherry on birch <b>8DC-P</b> dark cherry on birch <b>NB-P</b> natural on birch <b>MB-P</b> mocha on birch <b>CB-P</b> cherry on birch <b>2ML-P</b> natural maple on birch <b>3ML-P</b> light maple on birch <b>4ML-P</b> medium maple on birch <b>5ML-P</b> cherry maple on birch <b>EW-P</b> eggshell white (EW Durasyn on chassis)	<b>chemcast™</b> modesty grade 3	<b>2025</b> black <b>2069</b> blue <b>2247</b> white <b>2370</b> bronze <b>P-95</b> clear
<b>grade 1</b>	wood, laminate, durasyn, c.o.m.	<b>spacer &amp; frame finish</b>	<b>B</b> black <b>EW</b> eggshell white <b>S</b> silver		
<b>grade 2</b>	acrilux (5 unit minimum), fabric				
<b>grade 3</b>	chemcast™				
<b>edge</b>	<b>G</b>	<b>pulls</b>	all brio units ship standard with (square) pulls optional (twisted) pulls are available for no upcharge - specify (OP) for optional pull		







veneer top grade 1 insert		veneer top grade 2 insert		veneer top grade 3 insert		laminate top grade 1 insert		laminate top grade 2 insert		laminate top grade 3 insert	
list pricing zone 1	zone 2	list pricing zone 1	zone 2	list pricing zone 1	zone 2	list pricing zone 1	zone 2	list pricing zone 1	zone 2	list pricing zone 1	zone 2
1,862	2,011					1,666	1,860				
1,301	1,405										
1,530	1,652										
1,825	1,970	1,873	2,022	1,970	2,128						
875	946										
960	1,036	1,267	1,368	1,359	1,467						

laminat modesty grade 1	INSERTS
NB-P	natural birch on birch
CB-P	cherry birch on birch
2ML-P	natural maple on birch
3ML-P	light maple on birch
4ML-P	medium maple on birch
5ML-P	cherry on maple on birch
6LC-P	light cherry on birch
7MC-P	medium cherry on birch
8DC-P	dark cherry on birch
3L-P	saddle on walnut
4L-P	dark mahogany on walnut
25B-P	ebony on walnut
25M-P	mahogany on walnut
MB-P	mocha on birch
BA	black ashwood
BB	bethany beige
CF	copper fusion
CL	chili
CM	cardamom fiber
CN	cinnamon
CO	coriander fiber
CU	curacao fiber
EW	eggshell white
GS	graphite specktrum
GV	galvan
NV	negotiating in geneva
NV-G	negotiating in geneva gloss
OS	olive serenity
RA	rock of ages
SU	sugar fiber
TY	thyme fiber
WH	wheat fiber

veneer modesty grade 1	INSERTS
NB-W	natural birch on birch
CB-W	cherry birch on birch
6LC-W	light cherry on birch
7MC-W	medium cherry on birch
8DC-W	dark cherry on birch
MB-W	mocha birch on birch
2ML-W	natural maple on birch
3ML-W	light maple on birch
4ML-W	medium maple on birch
5ML-W	cherry on birch
1NC-W	natural cherry on cherry
2HC-W	honey cherry on cherry
9BC-W	burgundy cherry on cherry
88M-W	mahogany on cherry
2KL-W	sepia on walnut
3L-W	saddle on walnut
4L-W	dark mahogany on walnut
25C-W	cherry on walnut
25M-W	mahogany on walnut
25B-W	ebony on walnut
EW-W	eggshell white on birch
2ML-W	natural maple on birch
3ML-W	light maple on birch
4ML-W	medium maple on birch
5ML-W	cherry maple on birch

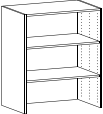
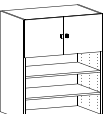
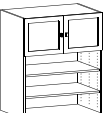
fabric modesty grade 2	INSERTS
322-001	rouge
322-009	copper
322-007	bronze
322-013	limelight
322-004	denim
322-000	taupe
323-001	rosewood
323-009	russet
323-019	amber
323-013	limelight
323-004	indigo
323-000	bronze
332-001	pomegranate
334-009	copper
334-007	moonbeam
334-013	limelight
334-004	cobalt
334-000	mocha
302-001	paprika
302-009	copper
302-002	bamboo
302-023	willow
302-014	admiral
302-000	chocolate
316-009	copper
316-019	red clay
316-008	plum
316-003	feldspar
316-024	turquoise
316-004	sapphire
316-010	taupe
316-006	smoke

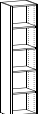
momentum axis	INSERTS
09102740	paprika
09102773	summer
09102718	grove
09102707	denim
09102729	noir
09102751	truffe
09097955	ascot
09097966	coin
09098021	trellis
09097977	imperial
09098010	shadow
09097999	mocha
09067502	garnet
09067481	amethyst
09067497	eco
09067529	sapphire
09067518	jet
09067540	steel
09067486	bayou
09067525	myth
09067492	bottle
09067532	sodalite
09067512	iron
09067545	system

	model number	description	d	w	h	freight
	HO2236 - _ - _	open hutch 2 adjustable shelves SOLID WOOD SHELVES (EACH) \$28 EXTRA SHELF (EACH) \$92	24	36	42.5	class 125 cwt 100 lb cu ft 19
	HWO2236 - _ - _	hutch with wood doors open below 2 adjustable shelves SOLID WOOD SHELVES (EACH) \$28 EXTRA SHELF (EACH) \$92	24	36	42.5	class 125 cwt 100 lb cu ft 19
	HWOF2236 - _ - _	hutch with framed door "inserts" open below 2 adjustable shelves SOLID WOOD SHELVES (EACH) \$28 EXTRA SHELF (EACH) \$92	24	36	42.5	class 125 cwt 100 lb cu ft 19
	EP2272 - _	24" d x 72" h case end panel USED TO MOUNT CASE HUNG OVERHEAD UNITS WHEN NOT USING CASE TOWER FOR SUPPORT	24	1.25	72	class 125 cwt 65 lb cu ft 3
	CT2272-BC - _ - _	case tower open bookcase 4 adjustable shelves SOLID WOOD SHELVES (EACH) \$28 EXTRA SHELF (EACH) \$92	15.25	17.25	72	class 125 cwt 200 lb cu ft 29
	CT2272-BC2F - _ - _ - _	case tower open bookcase above file/file below 2 adjustable shelves SOLID WOOD SHELVES (EACH) \$28 EXTRA SHELF (EACH) \$92	24	18	72	class 125 cwt 230 lb cu ft 29

**top material**  
P laminate top  
W veneer top

**modesty option key**  
W= veneer  
L= laminate  
D= durasyn  
C.O.M.  
A= acrilux  
F= fabric  
C= chemcast™

**grade 1** wood, laminate,  
durasyn, c.o.m.  
**grade 2** acrilux (5 unit minimum),  
fabric  
**grade 3** chemcast™

**edge**

G

**wood top & chassis finish**

**laminate top finish**

**spacer & frame finish**

**6LC-W** light cherry on birch  
**7MC-W** medium cherry on birch  
**8DC-W** dark cherry on birch  
**MB-W** mocha birch on birch  
**NB-W** natural birch on birch  
**CB-W** cherry birch on birch  
**2ML-W** natural maple on birch  
**3ML-W** light maple on birch  
**4ML-W** medium maple on birch  
**5ML-W** cherry maple on birch

**6LC-P** light cherry on birch  
**7MC-P** medium cherry on birch  
**8DC-P** dark cherry on birch  
**NB-P** natural on birch  
**MB-P** mocha on birch  
**CB-P** cherry on birch  
**2ML-P** natural maple on birch  
**3ML-P** light maple on birch  
**4ML-P** medium maple on birch  
**5ML-P** cherry maple on birch  
**EW-P** eggshell white (EW Durasyn on chassis)

**B** black  
**EW** eggshell white  
**S** silver

**pulls** all brio units ship standard with (square) pulls  
optional (twisted) pulls are available for no  
upcharge - specify (OP) for optional pull

**durasyn**  
modesty  
grade 1

**chemcast™**  
modesty  
grade 3

**INSERTS**  
**BP** black pearl  
**BL** black  
**CH** chinchilla  
**CT** cactus  
**EW** eggshell white  
**FG** fog  
**NB** natural beige  
**NG** northsea gray  
**PE** pearl  
**RK** rock  
**SD** sand  
**ST** sunset  
**TW** tumbleweed

**2025** black  
**2069** blue  
**2247** white  
**2370** bronze  
**P-95** clear

brío

| 2200 series

| wood top, veneer chassis, veneer drawer fronts

| laminate top, veneer chassis, veneer drawer fronts







veneer top grade 1 insert		veneer top grade 2 insert		veneer top grade 3 insert		laminate top grade 1 insert		laminate top grade 2 insert		laminate top grade 3 insert	
list pricing zone 1	zone 2	list pricing zone 1	zone 2	list pricing zone 1	zone 2	list pricing zone 1	zone 2	list pricing zone 1	zone 2	list pricing zone 1	zone 2
1,502	1,619										
2,016	2,086										
2,087	2,253	2,142	2,311	2,253	2,434						
455	492										
1,024	1,106										
1,940	2,095					1,295	1,399				

laminat modesty grade 1	INSERTS
NB-P	natural birch on birch
CB-P	cherry birch on birch
2ML-P	natural maple on birch
3ML-P	light maple on birch
4ML-P	medium maple on birch
5ML-P	cherry on maple on birch
6LC-P	light cherry on birch
7MC-P	medium cherry on birch
8DC-P	dark cherry on birch
3L-P	saddle on walnut
4L-P	dark mahogany on walnut
25B-P	ebony on walnut
25M-P	mahogany on walnut
MB-P	mocha on birch
BA	black ashwood
BB	bethany beige
CF	copper fusion
CL	chili
CM	cardamom fiber
CN	cinnamon
CO	coriander fiber
CU	curacao fiber
EW	eggshell white
GS	graphite specktrum
GV	galvan
NV	negotiating in geneva
NV-G	negotiating in geneva gloss
OS	olive serenity
RA	rock of ages
SU	sugar fiber
TY	thyme fiber
WH	wheat fiber

veneer modesty grade 1	INSERTS
NB-W	natural birch on birch
CB-W	cherry birch on birch
6LC-W	light cherry on birch
7MC-W	medium cherry on birch
8DC-W	dark cherry on birch
MB-W	mocha birch on birch
2ML-W	natural maple on birch
3ML-W	light maple on birch
4ML-W	medium maple on birch
5ML-W	cherry on birch
1NC-W	natural cherry on cherry
2HC-W	honey cherry on cherry
9BC-W	burgundy cherry on cherry
88M-W	mahogany on cherry
2KL-W	sepia on walnut
3L-W	saddle on walnut
4L-W	dark mahogany on walnut
25C-W	cherry on walnut
25M-W	mahogany on walnut
25B-W	ebony on walnut
EW-W	eggshell white on birch
2ML-W	natural maple on birch
3ML-W	light maple on birch
4ML-W	medium maple on birch
5ML-W	cherry maple on birch

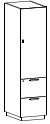
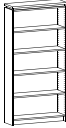
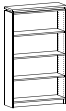
fabric modesty grade 2	INSERTS
322-001	rouge
322-009	copper
322-007	bronze
322-013	limelight
322-004	denim
322-000	taupe
323-001	rosewood
323-009	russet
323-019	amber
323-013	limelight
323-004	indigo
323-000	bronze
332-001	pomegranate
334-009	copper
334-007	moonbeam
334-013	limelight
334-004	cobalt
334-000	mocha
302-001	paprika
302-009	copper
302-002	bamboo
302-023	willow
302-014	admiral
302-000	chocolate
316-009	copper
316-019	red clay
316-008	plum
316-003	feldspar
316-024	turquoise
316-004	sapphire
316-010	taupe
316-006	smoke

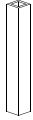
momentum axis	INSERTS
09102740	paprika
09102773	summer
09102718	grove
09102707	denim
09102729	noir
09102751	truffe
09097955	ascot
09097966	coin
09098021	trellis
09097977	imperial
09098010	shadow
09097999	mocha
09067502	garnet
09067481	amethyst
09067497	eco
09067529	sapphire
09067518	jet
09067540	steel
09067486	bayou
09067525	myth
09067492	bottle
09067532	sodalite
09067512	iron
09067545	system

	model number	description	d	w	h	freight
	CT2272R-HW2F - _ - _ - _ - CT2272L-HW2F - _ - _ - _ -	case tower hinge door cabinet above file/file below (R) hinge on right/knob on left (L) hinge on left/knob on right 2 adjustable shelves SOLID WOOD SHELVES (EACH) \$28 EXTRA SHELF (EACH) \$92	24	18	72	class 125 cwt 240 lb cu ft 29
	BC2272 - _ - _ -	bookcase three adjustable shelves one fixed shelf in center SOLID WOOD SHELVES (EACH) \$28 EXTRA SHELF (EACH) \$92	12	36	72	class 125 cwt 130 lb cu ft 24
	BC2260 - _ - _ -	bookcase two adjustable shelves one fixed shelf in center SOLID WOOD SHELVES (EACH) \$28 EXTRA SHELF (EACH) \$92	12	36	60	class 125 cwt 115 lb cu ft 20
	BC2248 - _ - _ -	bookcase one adjustable shelf one fixed shelf in center SOLID WOOD SHELVES (EACH) \$28 EXTRA SHELF (EACH) \$92	12	36	48	class 125 cwt 96 lb cu ft 16
	PLB - _ -	post leg base	4" dia			class 70 cwt 11 lb
	SQT2236 - _ - _ - _ -	36" square table with x-style base	36	36	29	class 125 cwt 70 lb

<b>top material</b>	<b>P</b> laminate top <b>W</b> veneer top	<b>wood top &amp; chassis finish</b>	<b>6LC-W</b> light cherry on birch <b>7MC-W</b> medium cherry on birch <b>8DC-W</b> dark cherry on birch <b>MB-W</b> mocha birch on birch <b>NB-W</b> natural birch on birch <b>CB-W</b> cherry birch on birch <b>2ML-W</b> natural maple on birch <b>3ML-W</b> light maple on birch <b>4ML-W</b> medium maple on birch <b>5ML-W</b> cherry maple on birch	<b>durasyn</b> modesty grade 1	<b>BP</b> black pearl <b>BL</b> black <b>CH</b> chinchilla <b>CT</b> cactus <b>EW</b> eggshell white <b>FG</b> fog <b>NB</b> natural beige <b>NG</b> northsea gray <b>PE</b> pearl <b>RK</b> rock <b>SD</b> sand <b>ST</b> sunset <b>TW</b> tumbleweed
<b>modesty option key</b>	<b>W</b> = veneer <b>L</b> = laminate <b>D</b> = durasyn <b>C.O.M.</b> <b>A</b> = acrilux <b>F</b> = fabric <b>C</b> = chemcast™	<b>laminate top finish</b>	<b>6LC-P</b> light cherry on birch <b>7MC-P</b> medium cherry on birch <b>8DC-P</b> dark cherry on birch <b>NB-P</b> natural on birch <b>MB-P</b> mocha on birch <b>CB-P</b> cherry on birch <b>2ML-P</b> natural maple on birch <b>3ML-P</b> light maple on birch <b>4ML-P</b> medium maple on birch <b>5ML-P</b> cherry maple on birch <b>EW-P</b> eggshell white (EW Durasyn on chassis)	<b>chemcast™</b> modesty grade 3	<b>2025</b> black <b>2069</b> blue <b>2247</b> white <b>2370</b> bronze <b>P-95</b> clear
<b>grade 1</b>	wood, laminate, durasyn, c.o.m.	<b>spacer &amp; frame finish</b>	<b>B</b> black <b>EW</b> eggshell white <b>S</b> silver		
<b>grade 2</b>	acrilux (5 unit minimum), fabric				
<b>grade 3</b>	chemcast™				
<b>edge</b>	<b>G</b>	<b>pulls</b>	all brio units ship standard with (square) pulls optional (twisted) pulls are available for no upcharge - specify (OP) for optional pull		

brío

| 2200 series



| wood top, veneer chassis, veneer drawer fronts

| laminate top, veneer chassis, veneer drawer fronts



veneer top grade 1 insert		veneer top grade 2 insert		veneer top grade 3 insert		laminate top grade 1 insert		laminate top grade 2 insert		laminate top grade 3 insert	
list pricing zone 1	zone 2	list pricing zone 1	zone 2	list pricing zone 1	zone 2	list pricing zone 1	zone 2	list pricing zone 1	zone 2	list pricing zone 1	zone 2
2,224	2,402										
1,699	1,836					1,556	1,679				
1,439	1,556					1,295	1,399				
1,185	1,280					1,040	1,123				
477	515										
1,755	1,895					825	891				

laminat	INSERTS	veneer	INSERTS	fabric	INSERTS	momentum	INSERTS
modesty grade 1	<b>NB-P</b> natural birch on birch <b>CB-P</b> cherry birch on birch <b>2ML-P</b> natural maple on birch <b>3ML-P</b> light maple on birch <b>4ML-P</b> medium maple on birch <b>5ML-P</b> cherry on maple on birch <b>6LC-P</b> light cherry on birch <b>7MC-P</b> medium cherry on birch <b>8DC-P</b> dark cherry on birch <b>3L-P</b> saddle on walnut <b>4L-P</b> dark mahogany on walnut <b>25B-P</b> ebony on walnut <b>25M-P</b> mahogany on walnut <b>MB-P</b> mocha on birch <b>BA</b> black ashwood <b>BB</b> bethany beige <b>CF</b> copper fusion <b>CL</b> chili <b>CM</b> cardamom fiber <b>CN</b> cinnamon <b>CO</b> coriander fiber <b>CU</b> curacao fiber <b>EW</b> eggshell white <b>GS</b> graphite specktrum <b>GV</b> galvan <b>NV</b> negotiating in geneva <b>NV-G</b> negotiating in geneva gloss <b>OS</b> olive serenity <b>RA</b> rock of ages <b>SU</b> sugar fiber <b>TY</b> thyme fiber <b>WH</b> wheat fiber	<b>NB-W</b> natural birch on birch <b>CB-W</b> cherry birch on birch <b>6LC-W</b> light cherry on birch <b>7MC-W</b> medium cherry on birch <b>8DC-W</b> dark cherry on birch <b>MB-W</b> mocha birch on birch <b>2ML-W</b> natural maple on birch <b>3ML-W</b> light maple on birch <b>4ML-W</b> medium maple on birch <b>5ML-W</b> cherry on birch <b>1NC-W</b> natural cherry on cherry <b>2HC-W</b> honey cherry on cherry <b>9BC-W</b> burgundy cherry on cherry <b>88M-W</b> mahogany on cherry <b>2KL-W</b> sepia on walnut <b>3L-W</b> saddle on walnut <b>4L-W</b> dark mahogany on walnut <b>25C-W</b> cherry on walnut <b>25M-W</b> mahogany on walnut <b>25B-W</b> ebony on walnut <b>EW-W</b> eggshell white on birch <b>2ML-W</b> natural maple on birch <b>3ML-W</b> light maple on birch <b>4ML-W</b> medium maple on birch <b>5ML-W</b> cherry maple on birch	<b>322-001</b> rouge <b>322-009</b> copper <b>322-007</b> bronze <b>322-013</b> limelight <b>322-004</b> denim <b>322-000</b> taupe <b>323-001</b> rosewood <b>323-009</b> russet <b>323-019</b> amber <b>323-013</b> limelight <b>323-004</b> indigo <b>323-000</b> bronze <b>332-001</b> pomegranate <b>334-009</b> copper <b>334-007</b> moonbeam <b>334-013</b> limelight <b>334-004</b> cobalt <b>334-000</b> mocha <b>302-001</b> paprika <b>302-009</b> copper <b>302-002</b> bamboo <b>302-023</b> willow <b>302-014</b> admiral <b>302-000</b> chocolate <b>316-009</b> copper <b>316-019</b> red clay <b>316-008</b> plum <b>316-003</b> feldspar <b>316-024</b> turquoise <b>316-004</b> sapphire <b>316-010</b> taupe <b>316-006</b> smoke	<b>09102740</b> paprika <b>09102773</b> summer <b>09102718</b> grove <b>09102707</b> denim <b>09102729</b> noir <b>09102751</b> truffie <b>09097955</b> ascot <b>09097966</b> coin <b>09098021</b> trellis <b>09097977</b> imperial <b>09098010</b> shadow <b>09097999</b> mocha <b>09067502</b> garnet <b>09067481</b> amethyst <b>09067497</b> eco <b>09067529</b> sapphire <b>09067518</b> jet <b>09067540</b> steel <b>09067486</b> bayou <b>09067525</b> myth <b>09067492</b> bottle <b>09067532</b> sodalite <b>09067512</b> iron <b>09067545</b> system			

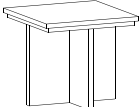
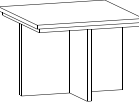
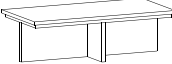
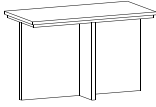
	model number	description	d	w	h	freight
	SQT2242 - _ - _ - _	42" square table with x-style base	42	42	29	class 125 cwt 80 lb
	SQT2248 - _ - _ - _	48" square table with x-style base	48	48	29	class 125 cwt 85 lb
	T2224-22 - _ - _ - _	lamp table with wood x base	24	24	22	class 125 cwt 35 lb cu ft 2
	T2230-22 - _ - _ - _	lamp table with wood x base	30	30	22	class 125 cwt 45 lb cu ft 3
	T2248-15 - _ - _ - _	sofa table with wood x base	24	48	15	class 125 cwt 60 lb cu ft 3
	T2248-29 - _ - _ - _	table with wood x base	24	48	29	class 125 cwt 65 lb cu ft 3

**top material**  
P laminate top  
W veneer top

**modesty option key**  
W= veneer  
L= laminate  
D= durasyn  
C.O.M.  
A= acrilux  
F= fabric  
C= chemcast™

**grade 1** wood, laminate,  
durasyn, c.o.m.  
**grade 2** acrilux (5 unit minimum),  
fabric  
**grade 3** chemcast™

**edge**

G

**wood top & chassis finish**

**laminate top finish**

**spacer & frame finish**

**6LC-W** light cherry on birch  
**7MC-W** medium cherry on birch  
**8DC-W** dark cherry on birch  
**MB-W** mocha birch on birch  
**NB-W** natural birch on birch  
**CB-W** cherry birch on birch  
**2ML-W** natural maple on birch  
**3ML-W** light maple on birch  
**4ML-W** medium maple on birch  
**5ML-W** cherry maple on birch

**6LC-P** light cherry on birch  
**7MC-P** medium cherry on birch  
**8DC-P** dark cherry on birch  
**NB-P** natural on birch  
**MB-P** mocha on birch  
**CB-P** cherry on birch  
**2ML-P** natural maple on birch  
**3ML-P** light maple on birch  
**4ML-P** medium maple on birch  
**5ML-P** cherry maple on birch  
**EW-P** eggshell white (EW Durasyn on chassis)

**B** black  
**EW** eggshell white  
**S** silver

**pulls** all brio units ship standard with (square) pulls  
optional (twisted) pulls are available for no  
upcharge - specify (OP) for optional pull

**durasyn**  
modesty  
grade 1



**chemcast™**  
modesty  
grade 3

**BP** black pearl  
**BL** black  
**CH** chinchilla  
**CT** cactus  
**EW** eggshell white  
**FG** fog  
**NB** natural beige  
**NG** northsea gray  
**PE** pearl  
**RK** rock  
**SD** sand  
**ST** sunset  
**TW** tumbleweed

**2025** black  
**2069** blue  
**2247** white  
**2370** bronze  
**P-95** clear



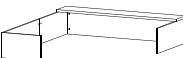
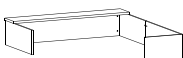
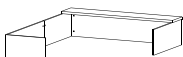

	model number	description	d w h	freight
	TD2272 - __	desk top transaction counter for use with 72" unit only	12 72 15.25	class 125 cwt 100 lb cu ft 8
	TD2266 - __	desk top transaction counter for use with 66" unit only	12 66 15.25	class 125 cwt 84 lb cu ft 6
	TD226630 - __	desk top transaction counter for use with 30" x 66" desk unit only	12 66 15.25	class 125 cwt 84 lb cu ft 6
	TM2272L - __	desk top transaction/reception gallery for use with executive 72" L unit	12 72 15.25	class 125 cwt 100 lb cu ft 8
	TM2272R - __	desk top transaction/reception gallery for use with executive 72" L unit	12 72 15.25	class 125 cwt 100 lb cu ft 8
	TM2266L - __	desk top transaction/reception gallery for use with executive 66" L unit	12 66 15.25	class 125 cwt 100 lb cu ft 8

<b>top material</b>	<b>P</b> laminate top <b>W</b> veneer top	<b>wood top &amp; chassis finish</b>	<b>6LC-W</b> light cherry on birch <b>7MC-W</b> medium cherry on birch <b>8DC-W</b> dark cherry on birch <b>MB-W</b> mocha birch on birch <b>NB-W</b> natural birch on birch <b>CB-W</b> cherry birch on birch <b>2ML-W</b> natural maple on birch <b>3ML-W</b> light maple on birch <b>4ML-W</b> medium maple on birch <b>5ML-W</b> cherry maple on birch	<b>durasyn</b> modesty grade 1	<b>BP</b> black pearl <b>BL</b> black <b>CH</b> chinchilla <b>CT</b> cactus <b>EW</b> eggshell white <b>FG</b> fog <b>NB</b> natural beige <b>NG</b> northsea gray <b>PE</b> pearl <b>RK</b> rock <b>SD</b> sand <b>ST</b> sunset <b>TW</b> tumbleweed
<b>modesty option key</b>	<b>W</b> = veneer <b>L</b> = laminate <b>D</b> = durasyn <b>C.O.M.</b> <b>A</b> = acrilux <b>F</b> = fabric <b>C</b> = chemcast™	<b>laminate top finish</b>	<b>6LC-P</b> light cherry on birch <b>7MC-P</b> medium cherry on birch <b>8DC-P</b> dark cherry on birch <b>NB-P</b> natural on birch <b>MB-P</b> mocha on birch <b>CB-P</b> cherry on birch <b>2ML-P</b> natural maple on birch <b>3ML-P</b> light maple on birch <b>4ML-P</b> medium maple on birch <b>5ML-P</b> cherry maple on birch <b>EW-P</b> eggshell white (EW Durasyn on chassis)	<b>chemcast™</b> modesty grade 3	<b>2025</b> black <b>2069</b> blue <b>2247</b> white <b>2370</b> bronze <b>P-95</b> clear
<b>grade 1</b>	wood, laminate, durasyn, c.o.m.	<b>spacer &amp; frame finish</b>	<b>B</b> black <b>EW</b> eggshell white <b>S</b> silver		
<b>grade 2</b>	acrilux (5 unit minimum), fabric				
<b>grade 3</b>	chemcast™				
<b>edge</b>	<b>G</b>	<b>pulls</b>	all brio units ship standard with (square) pulls optional (twisted) pulls are available for no upcharge - specify (OP) for optional pull		

brío

| 2200 series

| wood top, veneer chassis, veneer drawer fronts



| laminate top, veneer chassis, veneer drawer fronts



veneer top grade 1 insert		veneer top grade 2 insert		veneer top grade 3 insert		laminate top grade 1 insert		laminate top grade 2 insert		laminate top grade 3 insert	
list pricing zone 1	zone 2	list pricing zone 1	zone 2	list pricing zone 1	zone 2	list pricing zone 1	zone 2	list pricing zone 1	zone 2	list pricing zone 1	zone 2
882	953					882	953				
882	953					882	953				
882	953					882	953				
1,310	1,415					1,310	1,415				
1,310	1,415					1,310	1,415				
1,310	1,415					1,310	1,415				

laminat	INSERTS	veneer	INSERTS	fabric	INSERTS	momentum	INSERTS
modesty grade 1	<b>NB-P</b> natural birch on birch <b>CB-P</b> cherry birch on birch <b>2ML-P</b> natural maple on birch <b>3ML-P</b> light maple on birch <b>4ML-P</b> medium maple on birch <b>5ML-P</b> cherry on maple on birch <b>6LC-P</b> light cherry on birch <b>7MC-P</b> medium cherry on birch <b>8DC-P</b> dark cherry on birch <b>3L-P</b> saddle on walnut <b>4L-P</b> dark mahogany on walnut <b>25B-P</b> ebony on walnut <b>25M-P</b> mahogany on walnut <b>MB-P</b> mocha on birch <b>BA</b> black ashwood <b>BB</b> bethany beige <b>CF</b> copper fusion <b>CL</b> chili <b>CM</b> cardamom fiber <b>CN</b> cinnamon <b>CO</b> coriander fiber <b>CU</b> curacao fiber <b>EW</b> eggshell white <b>GS</b> graphite specktrum <b>GV</b> galvan <b>NV</b> negotiating in geneva <b>NV-G</b> negotiating in geneva gloss <b>OS</b> olive serenity <b>RA</b> rock of ages <b>SU</b> sugar fiber <b>TY</b> thyme fiber <b>WH</b> wheat fiber	<b>NB-W</b> natural birch on birch <b>CB-W</b> cherry birch on birch <b>6LC-W</b> light cherry on birch <b>7MC-W</b> medium cherry on birch <b>8DC-W</b> dark cherry on birch <b>MB-W</b> mocha birch on birch <b>2ML-W</b> natural maple on birch <b>3ML-W</b> light maple on birch <b>4ML-W</b> medium maple on birch <b>5ML-W</b> cherry on birch <b>1NC-W</b> natural cherry on cherry <b>2HC-W</b> honey cherry on cherry <b>9BC-W</b> burgundy cherry on cherry <b>88M-W</b> mahogany on cherry <b>2KL-W</b> sepia on walnut <b>3L-W</b> saddle on walnut <b>4L-W</b> dark mahogany on walnut <b>25C-W</b> cherry on walnut <b>25M-W</b> mahogany on walnut <b>25B-W</b> ebony on walnut <b>EW-W</b> eggshell white on birch <b>2ML-W</b> natural maple on birch <b>3ML-W</b> light maple on birch <b>4ML-W</b> medium maple on birch <b>5ML-W</b> cherry maple on birch	<b>modesty</b> grade 2 <b>mayer</b> catalyst <b>mayer</b> equation <b>mayer</b> lunar <b>mayer</b> paramount <b>mayer</b> element	<b>322-001</b> rouge <b>322-009</b> copper <b>322-007</b> bronze <b>322-013</b> limelight <b>322-004</b> denim <b>322-000</b> taupe <b>323-001</b> rosewood <b>323-009</b> russet <b>323-019</b> amber <b>323-013</b> limelight <b>323-004</b> indigo <b>323-000</b> bronze <b>332-001</b> pomegranate <b>334-009</b> copper <b>334-007</b> moonbeam <b>334-013</b> limelight <b>334-004</b> cobalt <b>334-000</b> mocha <b>302-001</b> paprika <b>302-009</b> copper <b>302-002</b> bamboo <b>302-023</b> willow <b>302-014</b> admiral <b>302-000</b> chocolate <b>316-009</b> copper <b>316-019</b> red clay <b>316-008</b> plum <b>316-003</b> feldspar <b>316-024</b> turquoise <b>316-004</b> sapphire <b>316-010</b> taupe <b>316-006</b> smoke	<b>axis</b> <b>momentum</b> russo <b>momentum</b> origin	<b>09102740</b> paprika <b>09102773</b> summer <b>09102718</b> grove <b>09102707</b> denim <b>09102729</b> noir <b>09102751</b> truffie <b>09097955</b> ascot <b>09097966</b> coin <b>09098021</b> trellis <b>09097977</b> imperial <b>09098010</b> shadow <b>09097999</b> mocha <b>09067502</b> garnet <b>09067481</b> amethyst <b>09067497</b> eco <b>09067529</b> sapphire <b>09067518</b> jet <b>09067540</b> steel <b>09067486</b> bayou <b>09067525</b> myth <b>09067492</b> bottle <b>09067532</b> sodalite <b>09067512</b> iron <b>09067545</b> system	

brío  
2200

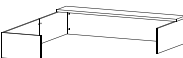
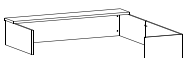
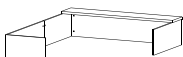
	model number	description	d w h	freight
	TD2272 - __	desk top transaction counter for use with 72" unit only	12 72 15.25	class 125 cwt 100 lb cu ft 8
	TD2266 - __	desk top transaction counter for use with 66" unit only	12 66 15.25	class 125 cwt 84 lb cu ft 6
	TD226630 - __	desk top transaction counter for use with 30" x 66" desk unit only	12 66 15.25	class 125 cwt 84 lb cu ft 6
	TM2272L - __	desk top transaction/reception gallery for use with executive 72" L unit	12 72 15.25	class 125 cwt 100 lb cu ft 8
	TM2272R - __	desk top transaction/reception gallery for use with executive 72" L unit	12 72 15.25	class 125 cwt 100 lb cu ft 8
	TM2266L - __	desk top transaction/reception gallery for use with executive 66" L unit	12 66 15.25	class 125 cwt 100 lb cu ft 8

<b>top material</b>	<b>P</b> laminate top <b>W</b> veneer top	<b>wood top &amp; chassis finish</b>	<b>6LC-W</b> light cherry on birch <b>7MC-W</b> medium cherry on birch <b>8DC-W</b> dark cherry on birch <b>MB-W</b> mocha birch on birch <b>NB-W</b> natural birch on birch <b>CB-W</b> cherry birch on birch <b>2ML-W</b> natural maple on birch <b>3ML-W</b> light maple on birch <b>4ML-W</b> medium maple on birch <b>5ML-W</b> cherry maple on birch	<b>durasyn</b> modesty grade 1	<b>BP</b> black pearl <b>BL</b> black <b>CH</b> chinchilla <b>CT</b> cactus <b>EW</b> eggshell white <b>FG</b> fog <b>NB</b> natural beige <b>NG</b> northsea gray <b>PE</b> pearl <b>RK</b> rock <b>SD</b> sand <b>ST</b> sunset <b>TW</b> tumbleweed
<b>modesty option key</b>	<b>W</b> = veneer <b>L</b> = laminate <b>D</b> = durasyn <b>C.O.M.</b> <b>A</b> = acrilux <b>F</b> = fabric <b>C</b> = chemcast™	<b>laminate top finish</b>	<b>6LC-P</b> light cherry on birch <b>7MC-P</b> medium cherry on birch <b>8DC-P</b> dark cherry on birch <b>NB-P</b> natural on birch <b>MB-P</b> mocha on birch <b>CB-P</b> cherry on birch <b>2ML-P</b> natural maple on birch <b>3ML-P</b> light maple on birch <b>4ML-P</b> medium maple on birch <b>5ML-P</b> cherry maple on birch <b>EW-P</b> eggshell white (EW Durasyn on chassis)	<b>chemcast™</b> modesty grade 3	<b>2025</b> black <b>2069</b> blue <b>2247</b> white <b>2370</b> bronze <b>P-95</b> clear
<b>grade 1</b>	wood, laminate, durasyn, c.o.m.	<b>spacer &amp; frame finish</b>	<b>B</b> black <b>EW</b> eggshell white <b>S</b> silver		
<b>grade 2</b>	acrilux (5 unit minimum), fabric				
<b>grade 3</b>	chemcast™				
<b>edge</b>	<b>G</b>	<b>pulls</b>	all brio units ship standard with (square) pulls optional (twisted) pulls are available for no upcharge - specify (OP) for optional pull		

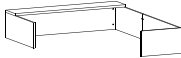
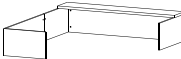
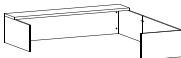
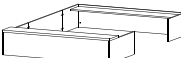
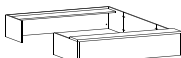
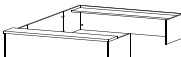

	model number	description	d w h	freight
	TM2266R - __	desk top transaction/reception gallery for use with executive 66" L unit	12 66 15.25	class 125 cwt 100 lb cu ft 8
	TM226630L - __	desk top transaction/reception gallery for use with executive 30" X 66" L unit	12 66 15.25	class 125 cwt 100 lb cu ft 8
	TM226630R - __	desk top transaction/reception gallery for use with executive 30" X 66" L unit	12 66 15.25	class 125 cwt 100 lb cu ft 8
	TU2272R - __	desk top transaction/reception gallery for use with executive 72" U unit	12 72 15.25	class 125 cwt 140 lb cu ft 10
	TU2272L - __	desk top transaction/reception gallery for use with executive 72" U unit	12 72 15.25	class 125 cwt 140 lb cu ft 10
	TU226630R - __	desk top transaction/reception gallery for use with 30" x 66" U unit	12 66 15.25	class 125 cwt 140 lb cu ft 10

<b>top material</b>	<b>P</b> laminate top <b>W</b> veneer top	<b>wood top &amp; chassis finish</b>	<b>6LC-W</b> light cherry on birch <b>7MC-W</b> medium cherry on birch <b>8DC-W</b> dark cherry on birch <b>MB-W</b> mocha birch on birch <b>NB-W</b> natural birch on birch <b>CB-W</b> cherry birch on birch <b>2ML-W</b> natural maple on birch <b>3ML-W</b> light maple on birch <b>4ML-W</b> medium maple on birch <b>5ML-W</b> cherry maple on birch	<b>durasyn</b> modesty grade 1	<b>BP</b> black pearl <b>BL</b> black <b>CH</b> chinchilla <b>CT</b> cactus <b>EW</b> eggshell white <b>FG</b> fog <b>NB</b> natural beige <b>NG</b> northsea gray <b>PE</b> pearl <b>RK</b> rock <b>SD</b> sand <b>ST</b> sunset <b>TW</b> tumbleweed
<b>modesty option key</b>	<b>W</b> = veneer <b>L</b> = laminate <b>D</b> = durasyn <b>C.O.M.</b> <b>A</b> = acrilux <b>F</b> = fabric <b>C</b> = chemcast™	<b>laminate top finish</b>	<b>6LC-P</b> light cherry on birch <b>7MC-P</b> medium cherry on birch <b>8DC-P</b> dark cherry on birch <b>NB-P</b> natural on birch <b>MB-P</b> mocha on birch <b>CB-P</b> cherry on birch <b>2ML-P</b> natural maple on birch <b>3ML-P</b> light maple on birch <b>4ML-P</b> medium maple on birch <b>5ML-P</b> cherry maple on birch <b>EW-P</b> eggshell white (EW Durasyn on chassis)	<b>chemcast™</b> modesty grade 3	<b>2025</b> black <b>2069</b> blue <b>2247</b> white <b>2370</b> bronze <b>P-95</b> clear
<b>grade 1</b>	wood, laminate, durasyn, c.o.m.	<b>spacer &amp; frame finish</b>	<b>B</b> black <b>EW</b> eggshell white <b>S</b> silver		
<b>grade 2</b>	acrilux (5 unit minimum), fabric				
<b>grade 3</b>	chemcast™				
<b>edge</b>	<b>G</b>	<b>pulls</b>	all brio units ship standard with (square) pulls optional (twisted) pulls are available for no upcharge - specify (OP) for optional pull		

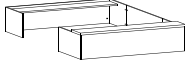
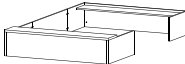
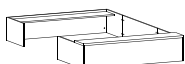

	model number	description	d w h	freight
	TU226630L - __	desk top transaction/reception gallery for use with 30" x 66" U unit	12 66 15.25	class 125 cwt 140 lb cu ft 10
	TU2266R - __	desk top transaction/reception gallery for use with 66" U unit	12 66 15.25	class 125 cwt 140 lb cu ft 10
	TU2266L - __	desk top transaction/reception gallery for use with 66" U unit	12 66 15.25	class 125 cwt 140 lb cu ft 10

**top material**  
P laminate top  
W veneer top

**modesty option key**  
W= veneer  
L= laminate  
D= durasyn  
C.O.M.  
A= acrilux  
F= fabric  
C= chemcast™

**grade 1** wood, laminate,  
durasyn, c.o.m.  
**grade 2** acrilux (5 unit minimum),  
fabric  
**grade 3** chemcast™

**edge**

G

**wood top & chassis finish**

**laminate top finish**

**spacer & frame finish**

**6LC-W** light cherry on birch  
**7MC-W** medium cherry on birch  
**8DC-W** dark cherry on birch  
**MB-W** mocha birch on birch  
**NB-W** natural birch on birch  
**CB-W** cherry birch on birch  
**2ML-W** natural maple on birch  
**3ML-W** light maple on birch  
**4ML-W** medium maple on birch  
**5ML-W** cherry maple on birch

**6LC-P** light cherry on birch  
**7MC-P** medium cherry on birch  
**8DC-P** dark cherry on birch  
**NB-P** natural on birch  
**MB-P** mocha on birch  
**CB-P** cherry on birch  
**2ML-P** natural maple on birch  
**3ML-P** light maple on birch  
**4ML-P** medium maple on birch  
**5ML-P** cherry maple on birch  
**EW-P** eggshell white (EW Durasyn on chassis)

**B** black  
**EW** eggshell white  
**S** silver

**pulls** all brío units ship standard with (square) pulls  
optional (twisted) pulls are available for no  
upcharge - specify (OP) for optional pull

**durasyn**  
modesty  
grade 1

**chemcast™**  
modesty  
grade 3

**INSERTS**  
**BP** black pearl  
**BL** black  
**CH** chinchilla  
**CT** cactus  
**EW** eggshell white  
**FG** fog  
**NB** natural beige  
**NG** northsea gray  
**PE** pearl  
**RK** rock  
**SD** sand  
**ST** sunset  
**TW** tumbleweed

**2025** black  
**2069** blue  
**2247** white  
**2370** bronze  
**P-95** clear

brío

| 2200 series

| wood top, veneer chassis, veneer drawer fronts

| laminate top, veneer chassis, veneer drawer fronts







veneer top grade 1 insert		veneer top grade 2 insert		veneer top grade 3 insert		laminate top grade 1 insert		laminate top grade 2 insert		laminate top grade 3 insert	
list pricing zone 1	zone 2	list pricing zone 1	zone 2	list pricing zone 1	zone 2	list pricing zone 1	zone 2	list pricing zone 1	zone 2	list pricing zone 1	zone 2
1,756	1,898					1,756	1,898				
1,310	1,415					1,310	1,415				
1,310	1,415					1,310	1,415				

laminat	INSERTS	veneer	INSERTS	fabric	INSERTS	momentum	INSERTS
modesty grade 1	<b>NB-P</b> natural birch on birch <b>CB-P</b> cherry birch on birch <b>2ML-P</b> natural maple on birch <b>3ML-P</b> light maple on birch <b>4ML-P</b> medium maple on birch <b>5ML-P</b> cherry on maple on birch <b>6LC-P</b> light cherry on birch <b>7MC-P</b> medium cherry on birch <b>8DC-P</b> dark cherry on birch <b>3L-P</b> saddle on walnut <b>4L-P</b> dark mahogany on walnut <b>25B-P</b> ebony on walnut <b>25M-P</b> mahogany on walnut <b>MB-P</b> mocha on birch <b>BA</b> black ashwood <b>BB</b> bethany beige <b>CF</b> copper fusion <b>CL</b> chili <b>CM</b> cardamom fiber <b>CN</b> cinnamon <b>CO</b> coriander fiber <b>CU</b> curacao fiber <b>EW</b> eggshell white <b>GS</b> graphite specktrum <b>GV</b> galvan <b>NV</b> negotiating in geneva <b>NV-G</b> negotiating in geneva gloss <b>OS</b> olive serenity <b>RA</b> rock of ages <b>SU</b> sugar fiber <b>TY</b> thyme fiber <b>WH</b> wheat fiber	modesty grade 1	<b>NB-W</b> natural birch on birch <b>CB-W</b> cherry birch on birch <b>6LC-W</b> light cherry on birch <b>7MC-W</b> medium cherry on birch <b>8DC-W</b> dark cherry on birch <b>MB-W</b> mocha birch on birch <b>2ML-W</b> natural maple on birch <b>3ML-W</b> light maple on birch <b>4ML-W</b> medium maple on birch <b>5ML-W</b> cherry on birch <b>1NC-W</b> natural cherry on cherry <b>2HC-W</b> honey cherry on cherry <b>9BC-W</b> burgundy cherry on cherry <b>88M-W</b> mahogany on cherry <b>2KL-W</b> sepia on walnut <b>3L-W</b> saddle on walnut <b>4L-W</b> dark mahogany on walnut <b>25C-W</b> cherry on walnut <b>25M-W</b> mahogany on walnut <b>25B-W</b> ebony on walnut <b>EW-W</b> eggshell white on birch <b>2ML-W</b> natural maple on birch <b>3ML-W</b> light maple on birch <b>4ML-W</b> medium maple on birch <b>5ML-W</b> cherry maple on birch	<b>modesty grade 2</b> <b>mayer catalyst</b> <b>mayer equation</b> <b>mayer lunar</b> <b>mayer paramount</b> <b>mayer element</b>	<b>322-001</b> rouge <b>322-009</b> copper <b>322-007</b> bronze <b>322-013</b> limelight <b>322-004</b> denim <b>322-000</b> taupe <b>323-001</b> rosewood <b>323-009</b> russet <b>323-019</b> amber <b>323-013</b> limelight <b>323-004</b> indigo <b>323-000</b> bronze <b>332-001</b> pomegranate <b>334-009</b> copper <b>334-007</b> moonbeam <b>334-013</b> limelight <b>334-004</b> cobalt <b>334-000</b> mocha <b>302-001</b> paprika <b>302-009</b> copper <b>302-002</b> bamboo <b>302-023</b> willow <b>302-014</b> admiral <b>302-000</b> chocolate <b>316-009</b> copper <b>316-019</b> red clay <b>316-008</b> plum <b>316-003</b> feldspar <b>316-024</b> turquoise <b>316-004</b> sapphire <b>316-010</b> taupe <b>316-006</b> smoke	<b>axis</b> <b>momentum russo</b> <b>momentum origin</b>	<b>09102740</b> paprika <b>09102773</b> summer <b>09102718</b> grove <b>09102707</b> denim <b>09102729</b> noir <b>09102751</b> truffie <b>09097955</b> ascot <b>09097966</b> coin <b>09098021</b> trellis <b>09097977</b> imperial <b>09098010</b> shadow <b>09097999</b> mocha <b>09067502</b> garnet <b>09067481</b> amethyst <b>09067497</b> eco <b>09067529</b> sapphire <b>09067518</b> jet <b>09067540</b> steel <b>09067486</b> bayou <b>09067525</b> myth <b>09067492</b> bottle <b>09067532</b> sodalite <b>09067512</b> iron <b>09067545</b> system

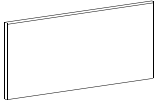

zoned pricing

	model number	description	d	w	h	freight	list \$ zone 1	zone 2
	USU84 - __	underside paper storage for use with 84" overhead storage unit does not prevent the use of task lights or tackboards  <i>NOT AVAILABLE ON WALL MOUNT UNITS FACTORY INSTALLED</i>	15.5	82	4		512	554
	USU72 - __	underside paper storage for use with 72" overhead storage units does not prevent the use of task lights or tackboards  <i>NOT AVAILABLE ON WALL MOUNT UNITS FACTORY INSTALLED</i>	15.5	70	4		498	536
	USU66 - __	underside paper storage for use with 66" overhead storage units does not prevent the use of task lights or tackboards  <i>NOT AVAILABLE ON WALL MOUNT UNITS FACTORY INSTALLED</i>	15.5	64	4		498	536
	USU48 - __	underside paper storage for use with 48" overhead storage units does not prevent the use of task lights or tackboards  <i>NOT AVAILABLE ON WALL MOUNT UNITS FACTORY INSTALLED</i>	15.5	46	4		292	315
	USU36 - __	underside paper storage for use with 36" overhead storage units does not prevent the use of task lights or tackboards  <i>NOT AVAILABLE ON WALL MOUNT UNITS FACTORY INSTALLED</i>	15.5	34	4		292	315
	TP2272 - __	tack panel USED WITH CASE HUNG OVERHEAD UNITS  COM Yardage: 2.25 Yards	.5	73.5	30	class 125 cwt 35 lb cu ft 4	388 396 416 425 439 450 460	416 426 450 459 474 486 498

**top material**  
P laminate top  
W veneer top

**modesty option key**  
W= veneer  
L= laminate  
D= durasyn  
C.O.M.  
A= acrilux  
F= fabric  
C= chemcast™

**grade 1** wood, laminate,  
durasyn, c.o.m.  
**grade 2** acrilux (5 unit minimum),  
fabric  
**grade 3** chemcast™

**edge**

G

**wood top & chassis finish**

**laminate top finish**

**spacer & frame finish**

**6LC-W** light cherry on birch  
**7MC-W** medium cherry on birch  
**8DC-W** dark cherry on birch  
**MB-W** mocha birch on birch  
**NB-W** natural birch on birch  
**CB-W** cherry birch on birch  
**2ML-W** natural maple on birch  
**3ML-W** light maple on birch  
**4ML-W** medium maple on birch  
**5ML-W** cherry maple on birch

**6LC-P** light cherry on birch  
**7MC-P** medium cherry on birch  
**8DC-P** dark cherry on birch  
**NB-P** natural on birch  
**MB-P** mocha on birch  
**CB-P** cherry on birch  
**2ML-P** natural maple on birch  
**3ML-P** light maple on birch  
**4ML-P** medium maple on birch  
**5ML-P** cherry maple on birch  
**EW-P** eggshell white (EW Durasyn on chassis)

**B** black  
**EW** eggshell white  
**S** silver

**pulls** all brio units ship standard with (square) pulls  
optional (twisted) pulls are available for no  
upcharge - specify (OP) for optional pull

**durasyn**  
modesty  
grade 1

**chemcast™**  
modesty  
grade 3

**BP** black pearl  
**BL** black  
**CH** chinchilla  
**CT** cactus  
**EW** eggshell white  
**FG** fog  
**NB** natural beige  
**NG** northsea gray  
**PE** pearl  
**RK** rock  
**SD** sand  
**ST** sunset  
**TW** tumbleweed

**2025** black  
**2069** blue  
**2247** white  
**2370** bronze  
**P-95** clear



	model number	description	d	w	h	freight	list \$ zone 1	zone 2
	TP2266 -	tack panel USED WITH CASE HUNG OVERHEAD UNITS  COM Yardage: 2 Yards	.5	67.5	30	class 125 cwt 32 lb cu ft 3	367 372 390 397 407 416 424	396 402 421 427 440 449 458
	TP2254 -	tack panel USED WITH CASE HUNG OVERHEAD UNITS  COM Yardage: 2 Yards	.5	55.5	30	class 125 cwt 27 lb cu ft 2	292 296 312 319 328 338 346	314 320 338 345 355 364 372
	TP2248 -	tack panel USED WITH CASE HUNG OVERHEAD UNITS  COM Yardage: 1.5 Yards	.5	37.5	30	class 125 cwt 19 lb cu ft 2	258 264 277 284 293 299 307	279 285 299 306 316 323 330
	TP2236 -	tack panel USED WITH CASE HUNG OVERHEAD UNITS  COM Yardage: 1.25 Yards	.5	37.5	30	class 125 cwt 19 lb cu ft 2	194 195 197 208 219 223 231	209 211 213 226 237 243 248
	RO7236 LB4	rectangular top with LB4 base  single post leg 4" diameter (black) 4 ea for above top	72	36	36	class 70 cwt 121 lb	2,285	2,467  as shown
	HS9646 LB2	hourglass table top with LB2 legs  single post leg 2" diameter (black) 4 ea for above top	96	46	36	class 70 cwt 190 lb	1,756	1,902  as shown

laminat	modesty	grade 1	veneer	modesty	grade 1	fabric	modesty	grade 2	mayer	catalyst	mayer	equation	mayer	lunar	mayer	paramount	mayer	element	momentum	axis	momentum	russo	momentum	origin	momentum	axis			
<b>INSERTS</b>	NB-P	natural birch on birch	<b>INSERTS</b>	NB-W	natural birch on birch	<b>INSERTS</b>	322-001	rouge	momentum	09102740	paprika	09102740	paprika	09102740	paprika	09102740	paprika	09102740	momentum	09102740	axis	09102740	axis	09102740	axis	09102740	axis		
CB-P	cherry birch on birch	CB-W	cherry birch on birch	322-009	copper	09102773	summer	322-007	bronze	09102718	grove	09102718	grove	322-013	limelight	09102707	denim	09102707	momentum	09098021	russo	09098021	russo	09098021	russo	09098021	russo		
2ML-P	natural maple on birch	6LC-W	light cherry on birch	322-013	limelight	09102729	noir	8DC-W	denim	09102729	noir	09102729	noir	322-004	taupe	09102751	truffe	09102751	momentum	09097955	ascot	09097955	ascot	09097955	ascot	09097955	ascot		
3ML-P	light maple on birch	7MC-W	medium cherry on birch	322-000	taupe	09098010	mocha	MB-W	taupe	09098010	mocha	09098010	mocha	2ML-W	natural maple on birch	323-001	rosewood	09097955	momentum	09097966	coin	09097966	coin	09097966	coin	09097966	coin		
4ML-P	medium maple on birch	8DC-W	dark cherry on birch	323-001	rosewood	09098021	trellis	3ML-W	rosewood	09098021	trellis	09098021	trellis	4ML-W	medium maple on birch	323-009	russet	09097977	momentum	09097977	imperial	09097977	imperial	09097977	imperial	09097977	imperial		
5ML-P	cherry on maple on birch	1NC-W	cherry on birch	323-019	amber	09098010	shadow	4ML-W	amber	09098010	shadow	09098010	shadow	5ML-W	cherry on birch	323-013	limelight	09097910	momentum	09098010	mocha	09098010	mocha	09098010	mocha	09098010	mocha		
6LC-P	light cherry on birch	2HC-W	natural cherry on cherry	323-004	indigo	09097999	mocha	5ML-W	indigo	09097999	mocha	09097999	mocha	BA	natural cherry on cherry	323-000	bronze	09097502	momentum	09067502	garnet	09067502	garnet	09067502	garnet	09067502	garnet		
7MC-P	medium cherry on birch	9BC-W	burgundy cherry on cherry	332-001	pomegranate	09067481	amethyst	2HC-W	pomegranate	09067481	amethyst	09067481	amethyst	BB	honey cherry on cherry	334-009	copper	09067497	momentum	09067497	eco	09067497	eco	09067497	eco	09067497	eco		
8DC-P	dark cherry on birch	88M-W	mahogany on cherry	334-007	moonbeam	09067529	sapphire	9BC-W	moonbeam	09067529	sapphire	09067529	sapphire	CF	mahogany on cherry	334-013	limelight	09067518	momentum	09067518	jet	09067518	jet	09067518	jet	09067518	jet		
3L-P	saddle on walnut	2KL-W	sepia on walnut	334-004	cobalt	09067540	steel	88M-W	limelight	09067540	steel	09067540	steel	CL	saddle on walnut	334-000	mocha	09067486	momentum	09067486	bayou	09067486	bayou	09067486	bayou	09067486	bayou		
4L-P	dark mahogany on walnut	3L-W	saddle on walnut	302-001	paprika	09067525	myth	2KL-W	mocha	09067525	myth	09067525	myth	CM	dark mahogany on walnut	302-009	copper	09067492	momentum	09067492	bottle	09067492	bottle	09067492	bottle	09067492	bottle		
25B-P	ebony on walnut	4L-W	dark mahogany on walnut	302-002	copper	09067532	sodalite	3L-W	copper	09067532	sodalite	09067532	sodalite	CN	cherry on walnut	302-000	bamboo	09067512	momentum	09067512	iron	09067512	iron	09067512	iron	09067512	iron		
25M-P	mahogany on walnut	2ML-W	natural maple on birch	302-023	willow	09067545	system	4L-W	bamboo	09067545	system	09067545	system	CO	cherry on walnut	302-014	admiral												
MB-P	mocha on birch	3ML-W	light maple on birch	302-000	chocolate			2ML-W	chocolate					CU	cherry on walnut	316-009	copper												
BA	black ashwood	4ML-W	medium maple on birch	316-019	red clay			EW-W	red clay					CS	cherry on walnut	316-008	plum												
BB	bethany beige	5ML-W	cherry maple on birch	316-003	feldspar			EW-W	plum					GS	cherry on walnut	316-024	turquoise												
CF	copper fusion			316-004	sapphire			EW-W	feldspar					GV	cherry on walnut	316-010	taupe												
CL	chili			316-006	smoke			EW-W	turquoise					NV	cherry on walnut														
CM	cardamom fiber							EW-W	taupe					NV-G	cherry on walnut														
CN	cinnamon							EW-W	smoke					OS	cherry on walnut														
CO	coriander fiber							EW-W						RA	cherry on walnut														
CU	curacao fiber							EW-W						SU	cherry on walnut														
EW	eggshell white							EW-W						TY	cherry on walnut														
GS	graphite specktrum							EW-W						WH	cherry on walnut														
GV	galvan							EW-W																					
NV	negotiating in geneva							EW-W																					
NV-G	negotiating in geneva gloss							EW-W																					
OS	olive serenity							EW-W																					
RA	rock of ages							EW-W																					
SU	sugar fiber							EW-W																					
TY	thyme fiber							EW-W																					
WH	wheat fiber							EW-W																					

# inwood

OFFICE  
ENVIRONMENTS

## price list

effective 01 january 2012

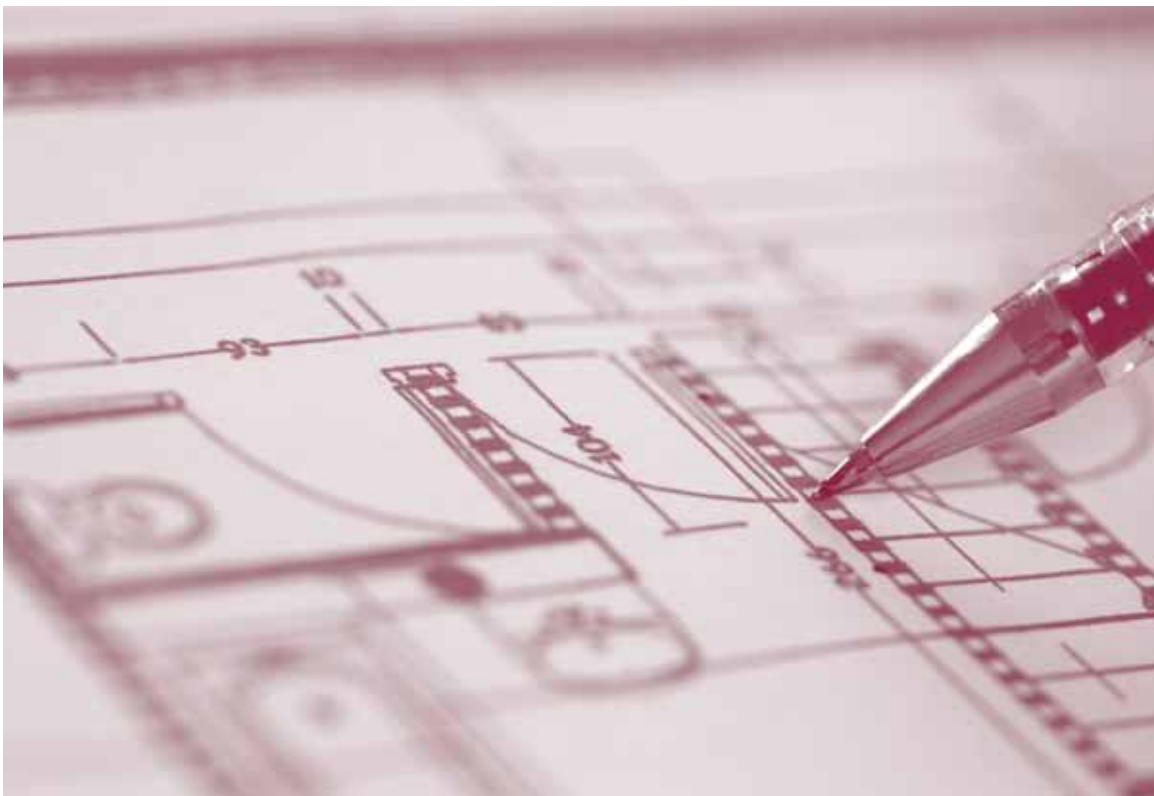

account # \_\_\_\_\_  
discount \_\_\_\_\_  
zone \_\_\_\_\_  
c.s.r. \_\_\_\_\_  
sales rep. \_\_\_\_\_

## ovation/bravo

2300/2100

[click here for warranty  
and terms information](#)

zones one and two



# inwood

OFFICE  
ENVIRONMENTS

---



ovation/bravo  
2300/2100

### ovation/bravo 2300/2100 series specifications

#### materials:

All wood is thoroughly air and kiln dried to a moisture content not to exceed 8% at the time of assembly.

#### top work surfaces:

- **Veneer tops** are 1 1/4" thick, 5-ply construction; consisting of 1/40" thick Walnut veneer work surface and a backing. The top core material is a 45 lb. density particleboard, with a choice of top edge shape solid wood sides. All exposed surfaces are plain sliced Cherry, American Black Walnut or White Maple Veneer. Walnut veneers are carefully book-matched. Cherry and Maple veneers are slip-matched. All drawer fronts, doors, end panels, and modesty panels are vertical grain.
- **Laminate tops** are 1 1/4" thick, 3-ply construction; consisting of a high-pressure laminate work surface and a 45 lb. density flake board core. The under side of the top has a smooth surface Gator-Ply backing sheet. Top rims are 3/4" hardwood with a choice of top edge shape on all four sides.

#### modesty panels:

3/4" thick, 3-ply construction with a vertical book matched veneer on exposed surfaces and a 45 lb. density flake board core. Desk modesty panels are full to the floor.

#### construction:

Uses a mortise & tenon and glue to join panels and modesty panels. All joints are reinforced with glue blocks. Each desk pedestal has an easy slide out dictation arm/mousing slide mounted above the drawers for more work surface area (exception is the 24x48" desks). All pedestals have a side route finger drawer pulls. Bookcase shelves are standard 3/4" thick.

#### drawers:

Drawer fronts are 3/4" thick, 3-ply construction with vertical book matched veneer. Drawer edges are veneered on top and sides with matching wood veneers. All drawer sides and backs are plywood, dovetailed front and back with 3-ply drawer bottoms. Drawer bottoms are framed on four sides and stapled from the bottom side. Drawer interiors are finished with a clear coat sealer to prevent swelling or shrinkage. Box drawers have a high grade Sterling metal ball-bearing drawer suspension. File drawers have a high grade Sterling metal ball bearing full progressive suspension and are equipped with metal rods for hanging file folders. All drawers have smooth quiet operation.

#### inside drawer dimensions:

box drawers: 4" H x 12 1/8" W x 15 9/16" L  
 4" H x 12 1/8" W x 22 1/8" L  
 file drawers: 9 1/2" H x 12 1/8" W x 15 9/16" L  
 9 1/2" H x 12 1/8" W x 25 3/8" L  
 lateral files: 9 1/2" H x 32 5/8" W x 16" L

#### locking:

Each pedestal has its own lock and is keyed alike for each unit. Each unit is equipped with two keys. Units may be keyed alike in groups (per office, if requested) for an additional charge of \$37 list per unit.

#### finish:

All Inwood finishes are catalyzed varnish and have excellent durability. Our multi-step satin finishes leave a beautiful natural look to the furniture, and are available in the following finishes: (3L) saddle on walnut, (2KL) sepia on walnut, (25M) mahogany on walnut, (4L) dark mahogany on walnut, (25C) cherry on walnut, (2ML) natural maple on maple, (3ML) light maple on maple, (4ML) medium maple on maple, (5ML) cherry finish on maple, (6LC) light cherry on cherry, (7MC) medium cherry on cherry, (8DC) dark cherry on cherry, (9BC) burgundy cherry on cherry, (25B) ebony on walnut.

#### pulls/grommets:

\$138 list upcharge for putting any additional pulls on a 2300/2100 unit if no optional pulls specified, black grommets will be used. If optional pulls specified, silver grommets will be used.

forte:



allegro:



presto:

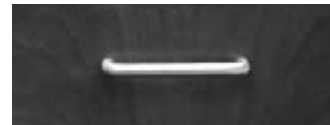

#### modesty and overhead door options:



glass (doors only)



veneer

ovation/bravo

2300 series  
2100 series

| wood top, veneer chassis, veneer drawer fronts  
| laminate top, veneer chassis, veneer drawer fronts



ovation/bravo

letter  
front to back

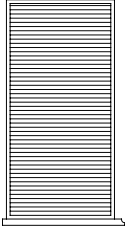

letter  
side to side

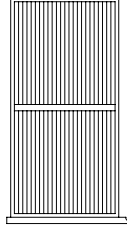

letter/legal  
combination

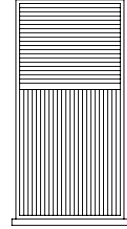

returns  
and  
credenzas

letter  
front to back

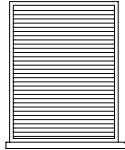

letter  
side to side

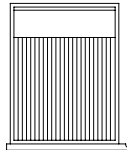

letter  
front to back

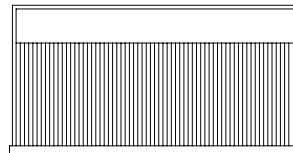
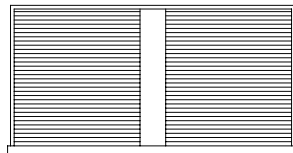
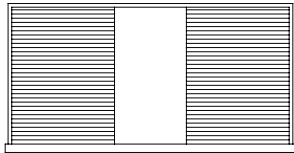



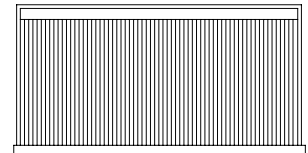

legal  
side to side

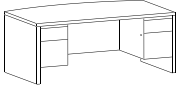
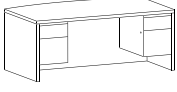
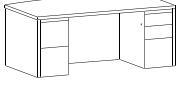
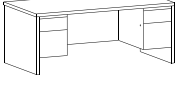
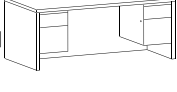
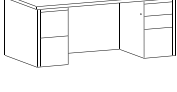

## FBT2372-3Q-3L-W-E

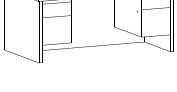
unit identification (type), top dimension, chassis option - chassis & top finish - top material - edge option

	model number	description	d w h	freight	list \$ zone 1	list \$ zone 2
	<b>FBT2372-3Q</b> - _ - _ - _ <b>FBT2172-3Q</b> - _ - _ - _	bow front double pedestal desk left and right box/file pedestals pull-out slide over each pedestal	42 72 29 <i>APPROACH: 13"</i> <i>KNEESPACE: 40"</i>	class 125 cwt 320 lb cu ft 55	<b>4,848 W</b>  <b>4,429 P</b>	<b>5,243 W</b>  <b>4,764 P</b>
	<b>FBT2372-FM</b> - _ - _ - _ <b>FBT2172-FM</b> - _ - _ - _	bow front double pedestal desk left and right box/file pedestals pull-out slide over each pedestal	42 72 29 <i>APPROACH: 13"</i> <i>KNEESPACE: 40"</i>	class 125 cwt 330 lb cu ft 55	<b>5,018 W</b>  <b>4,576 P</b>	<b>5,416 W</b>  <b>4,924 P</b>
	<b>FBT2372-FP</b> - _ - _ - _ <b>FBT2172-FP</b> - _ - _ - _	bow front double pedestal desk left file/file pedestal right box/box/file pedestal pull-out slide over each pedestal	42 72 29 <i>APPROACH: 13"</i> <i>KNEESPACE: 40"</i>	class 125 cwt 370 lb cu ft 55	<b>5,688 W</b>  <b>4,989 P</b>	<b>6,135 W</b>  <b>5,566 P</b>
	<b>F2372-3Q</b> - _ - _ - _ <b>F2172-3Q</b> - _ - _ - _	double pedestal desk left and right box/file pedestals pull-out slide over each pedestal	36 72 29 <i>APPROACH: 7"</i> <i>KNEESPACE: 40"</i>	class 125 cwt 315 lb cu ft 53	<b>3,415 W</b>  <b>2,855 P</b>	<b>3,688 W</b>  <b>3,110 P</b>
[ QS ] 	<b>F2372-FM</b> - _ - _ - _ <b>F2172-FM</b> - _ - _ - _  Quick Ship available in 8DC dark cherry with B edge	double pedestal desk left and right box/file pedestals pull-out slide over each pedestal	36 72 29 <i>APPROACH: 7"</i> <i>KNEESPACE: 40"</i>	class 125 cwt 325 lb cu ft 53	<b>3,483 W</b>  <b>2,892 P</b>	<b>3,762 W</b>  <b>3,235 P</b>
[ QS ] 	<b>F2372-FP</b> - _ - _ - _ <b>F2172-FP</b> - _ - _ - _  Quick Ship available in 25M mahogany with C edge	double pedestal desk left file/file pedestal right box/box/file pedestal pull-out slide over each pedestal	36 72 29 <i>APPROACH: 7"</i> <i>KNEESPACE: 40"</i>	class 125 cwt 365 lb cu ft 53	<b>3,851 W</b>  <b>3,453 P</b>	<b>4,153 W</b>  <b>3,728 P</b>
	<b>F2366-3Q</b> - _ - _ - _ <b>F2166-3Q</b> - _ - _ - _	double pedestal desk left and right box/file pedestals pull-out slide over each pedestal	36 66 29 <i>APPROACH: 7"</i> <i>KNEESPACE: 34"</i>	class 125 cwt 300 lb cu ft 48	<b>3,266 W</b>  <b>2,816 P</b>	<b>3,528 W</b>  <b>3,044 P</b>
	<b>F2366-FM</b> - _ - _ - _ <b>F2166-FM</b> - _ - _ - _	double pedestal desk left and right box/file pedestals pull-out slide over each pedestal	36 66 29 <i>APPROACH: 7"</i> <i>KNEESPACE: 34"</i>	class 125 cwt 310 lb cu ft 48	<b>3,368 W</b>  <b>2,883 P</b>	<b>3,637 W</b>  <b>3,113 P</b>
	<b>F2366-FP</b> - _ - _ - _ <b>F2166-FP</b> - _ - _ - _	double pedestal desk left file/file pedestal right box/box/file pedestal pull-out slide over each pedestal	36 66 29 <i>APPROACH: 7"</i> <i>KNEESPACE: 34"</i>	class 125 cwt 335 lb cu ft 48	<b>3,749 W</b>  <b>3,414 P</b>	<b>4,047 W</b>  <b>3,686 P</b>

top

laminat  
topveneer top

\$138 list upcharge for putting any additional pulls on a  
2300/2100 unit → allegro → forte → presto



ovation/bravo | 2300 series  
2100 series

| wood top, veneer chassis, veneer drawer fronts  
| laminate top, veneer chassis, veneer drawer fronts

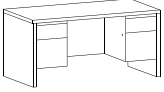
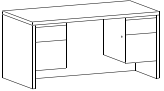
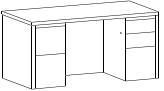
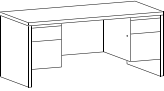
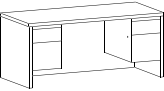
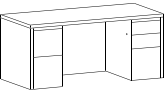
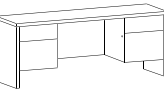
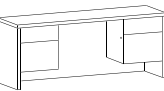
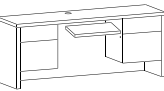

ovation/bravo  
2300/2100

	model number	description	30 60 29 APPROACH: 6" KNEESPACE: 28"	freight class 125 cwt 245 lb cu ft 37	list \$ zone 1 2,765 W	zone 2 2,986 W
	<b>F2360-3Q</b> - _ - _ - _ <b>F2160-3Q</b> - _ - _ - _	double pedestal desk left and right box/file pedestals pull-out slide over each pedestal			<b>2,401 P</b>	<b>2,580 P</b>
	<b>F2360-FM</b> - _ - _ - _ <b>F2160-FM</b> - _ - _ - _	double pedestal desk left and right box/file pedestals pull-out slide over each pedestal			<b>2,527 P</b>	<b>2,717 P</b>
	<b>F2360-FP</b> - _ - _ - _ <b>F2160-FP</b> - _ - _ - _	double pedestal desk left file/file pedestal right box/box/file pedestal pull-out slide over each pedestal			<b>2,928 P</b>	<b>3,149 P</b>
	<b>F236630-3Q</b> - _ - _ - _ <b>F216630-3Q</b> - _ - _ - _	double pedestal desk left and right box/file pedestals pull-out slide over each pedestal			<b>2,573 P</b>	<b>2,777 P</b>
	<b>F236630-FM</b> - _ - _ - _ <b>F216630-FM</b> - _ - _ - _	double pedestal desk left and right box/file pedestals pull-out slide over each pedestal			<b>2,638 P</b>	<b>2,849 P</b>
	<b>F236630-FP</b> - _ - _ - _ <b>F216630-FP</b> - _ - _ - _	double pedestal desk left file/file pedestal right box/box/file pedestal pull-out slide over each pedestal			<b>3,012 P</b>	<b>3,253 P</b>
	<b>CR2372-3Q</b> - _ - _ - _ <b>CR2172-3Q</b> - _ - _ - _	kneespace credenza left and right box/file pedestals			<b>2,256 P</b>	<b>2,425 P</b>
	<b>CR2372-FM</b> - _ - _ - _ <b>CR2172-FM</b> - _ - _ - _	kneespace credenza left and right box/file pedestals			<b>2,301 P</b>	<b>2,564 P</b>
	<b>CR2372-FMKB</b> - _ - _ - _ <b>CR2172-FMKB</b> - _ - _ - _	kneespace credenza - keyboard left and right box/file pedestals grommet			<b>2,664 P</b>	<b>2,958 P</b>

[ QS ]

Quick Ship available in 8DC dark cherry with B edge

**chassis models**

<b>3Q</b> 3/4 pedestal 3/4 modesty	<b>3L-P</b> saddle on walnut <b>4L-P</b> dark mahogany on walnut <b>25M-P</b> mahogany on walnut <b>25B-P</b> ebony on walnut <b>25C-P</b> cherry on walnut <b>2ML-P</b> natural maple <b>3ML-P</b> light maple <b>4ML-P</b> medium maple <b>5ML-P</b> cherry on maple <b>6LC-P</b> light cherry on cherry <b>7MC-P</b> medium cherry on cherry <b>8DC-P</b> dark cherry on cherry	<b>veneer</b> top and chassis finish	<b>3L-W</b> saddle on walnut <b>2KL-W</b> sepia on walnut <b>4L-W</b> dark mahogany on walnut <b>25M-W</b> mahogany on walnut <b>25B-W</b> ebony on walnut <b>25C-W</b> cherry on walnut <b>2ML-W</b> natural maple <b>3ML-W</b> light maple <b>4ML-W</b> medium maple <b>5ML-W</b> cherry on maple <b>6LC-W</b> light cherry on cherry <b>1NC-W</b> natural cherry on cherry <b>2HC-W</b> honey cherry on cherry	<b>7MC-W</b> medium cherry on cherry <b>8DC-W</b> dark cherry on cherry <b>9BC-W</b> burgundy cherry on cherry
---------------------------------------	---	---	---	--



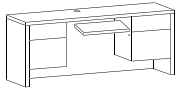

**model number**

CR237224-FMKB - \_ - \_

- - -

CR217224-FMKB - \_ - \_

- - -

**description**

kneespace credenza - keyboard  
left and right box/file pedestals  
grommet

**d w h**

24 72 29

*KNEESPACE: 40"*

**freight**

class 125  
cwt 250 lb  
cu ft 28

**list \$ zone 1**

**3,364 W**

**3,193 P**

**list \$ zone 2**

**3,644 W**

**3,446 P**

[ QS ]

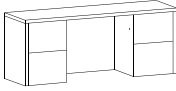

CR2372-FP - \_ - \_ - \_

Quick ship available in 25m mahogany  
with C edge with KB platform add  
\$370.00 list for KB platform.

CR2172-FP - \_ - \_ - \_

kneespace credenza  
left and right file/file pedestals

20 72 29

*KNEESPACE: 40"*

class 125  
cwt 285 lb  
cu ft 28

**3,121 W**

**2,598 P**

**3,371 W**

**2,805 P**

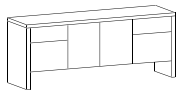

CR2372D-3Q - \_ - \_ - \_

- - -

CR2172D-3Q - \_ - \_ - \_

- - -

storage credenza  
left and right box/file pedestals  
double hinged door center  
one adjustable shelf

20 72 29

class 125  
cwt 250 lb  
cu ft 28

**2,747 W**

**2,466 P**

**2,968 W**

**2,652 P**

ADDITIONAL SHELVES (EACH) **\$92**  
SOLID WOOD SHELVES (EACH) **\$434**

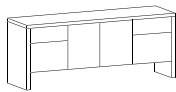

CR237224D-3Q - \_ - \_ - \_

- - -

CR217224D-3Q - \_ - \_ - \_

- - -

storage credenza  
left and right box/file pedestals  
double hinged door center  
one adjustable shelf

24 72 29

class 125  
cwt 250 lb  
cu ft 28

**3,097 W**

**2,871 P**

**3,345 W**

**3,102 P**

ADDITIONAL SHELVES (EACH) **\$92**  
SOLID WOOD SHELVES (EACH) **\$434**

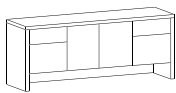

CR2372D-FM - \_ - \_ - \_

- - -

CR2172D-FM - \_ - \_ - \_

- - -

storage credenza  
left and right box/file pedestals  
double hinged door center  
one adjustable shelf

20 72 29

class 125  
cwt 260 lb  
cu ft 28

**2,805 W**

**2,577 P**

**3,029 W**

**2,770 P**

ADDITIONAL SHELVES (EACH) **\$92**  
SOLID WOOD SHELVES (EACH) **\$434**

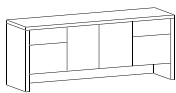

CR237224D-FM - \_ - \_ - \_

- - -

CR217224D-FM - \_ - \_ - \_

- - -

storage credenza  
left and right box/file pedestals  
double hinged door center  
one adjustable shelf

24 72 29

class 125  
cwt 260 lb  
cu ft 28

**3,172 W**

**2,947 P**

**3,425 W**

**3,182 P**

ADDITIONAL SHELVES (EACH) **\$92**  
SOLID WOOD SHELVES (EACH) **\$434**

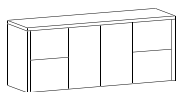

CR2372D-FP - \_ - \_ - \_

- - -

CR2172D-FP - \_ - \_ - \_

- - -

storage credenza  
left and right file/file pedestals  
double hinged door center  
one adjustable shelf

20 72 29

class 125  
cwt 290 lb  
cu ft 28

**3,421 W**

**2,928 P**

**3,608 W**

**3,149 P**

ADDITIONAL SHELVES (EACH) **\$92**  
SOLID WOOD SHELVES (EACH) **\$434**

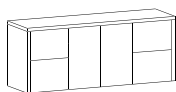

CR237224D-FP - \_ - \_ - \_

- - -

CR217224D-FP - \_ - \_ - \_

- - -

storage credenza  
left and right file/file pedestals  
double hinged door center  
one adjustable shelf

24 72 29

class 125  
cwt 290 lb  
cu ft 28

**3,807 W**

**3,581 P**

**4,111 W**

**3,868 P**

ADDITIONAL SHELVES (EACH) **\$92**  
SOLID WOOD SHELVES (EACH) **\$434**

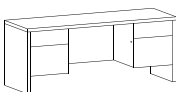

CR237224-3Q - \_ - \_ - \_

- - -

CR217224-3Q - \_ - \_ - \_

- - -

kneespace credenza  
computer depth  
left and right box/file pedestals

24 72 29

*KNEESPACE: 40"*

class 125  
cwt 230 lb  
cu ft 34

**2,840 W**

**2,661 P**

**3,068 W**

**2,860 P**

**top**

laminat  
topveneer top

\$138 list upcharge for putting any additional pulls on a  
2300/2100 unit → allegro → forte → presto



ovation/bravo | 2300 series  
2100 series

| wood top, veneer chassis, veneer drawer fronts  
| laminate top, veneer chassis, veneer drawer fronts



ovation/bravo  
2300/2100

	model number	description		freight	list \$ zone 1	zone 2
	CR237224-FM - _ - _ - _	kneespace credenza computer depth left and right box/file pedestals	24 72 29 KNEESPACE: 40"	class 125 cwt 260 lb cu ft 34	2,987 W	3,226 W
	CR217224-FM - _ - _ - _				2,815 P	3,026 P
	CR237224-FP - _ - _ - _	kneespace credenza computer depth left and right file/file pedestals	24 72 29 KNEESPACE: 40"	class 125 cwt 270 lb cu ft 34	3,230 W	3,491 W
	CR217224-FP - _ - _ - _				2,982 P	3,354 P
	CR2366-3Q - _ - _ - _	kneespace credenza left and right box/file pedestals	20 66 29 KNEESPACE: 34"	class 125 cwt 210 lb cu ft 26	2,365 W	2,555 W
	CR2166-3Q - _ - _ - _				2,089 P	2,249 P
	CR2366-FM - _ - _ - _	kneespace credenza left and right box/file pedestals	20 66 29 KNEESPACE: 34"	class 125 cwt 235 lb cu ft 26	2,448 W	2,644 W
	CR2166-FM - _ - _ - _				2,189 P	2,353 P
	CR2366-FP - _ - _ - _	kneespace credenza left and right file/file pedestals	20 66 29 KNEESPACE: 34"	class 125 cwt 260 lb cu ft 26	2,860 W	3,093 W
	CR2166-FP - _ - _ - _				2,508 P	2,696 P
	CR2366D-3Q - _ - _ - _	storage credenza left and right box/file pedestals double hinged door center one adjustable shelf	20 66 29	class 125 cwt 225 lb cu ft 26	2,642 W	2,850 W
	CR2166D-3Q - _ - _ - _	ADDITIONAL SHELVES (EACH) \$92 SOLID WOOD SHELVES (EACH) \$434			2,302 P	2,475 P
	CR236624D-3Q - _ - _ - _	storage credenza left and right box/file pedestals double hinged door center one adjustable shelf	24 66 29	class 125 cwt 225 lb cu ft 26	2,994 W	3,233 W
	CR216624D-3Q - _ - _ - _	ADDITIONAL SHELVES (EACH) \$92 SOLID WOOD SHELVES (EACH) \$434			2,814 P	3,040 P
	CR2366D-FM - _ - _ - _	storage credenza left and right box/file pedestals double hinged door center one adjustable shelf	20 66 29	class 125 cwt 230 lb cu ft 26	2,696 W	2,912 W
	CR2166D-FM - _ - _ - _	ADDITIONAL SHELVES (EACH) \$92 SOLID WOOD SHELVES (EACH) \$434			2,455 P	2,640 P
	CR236624D-FM - _ - _ - _	storage credenza left and right box/file pedestals double hinged door center one adjustable shelf	24 66 29	class 125 cwt 230 lb cu ft 26	3,061 W	3,307 W
	CR216624D-FM - _ - _ - _	ADDITIONAL SHELVES (EACH) \$92 SOLID WOOD SHELVES (EACH) \$434			2,892 P	3,123 P

chassis models

<b>3Q</b> 3/4 pedestal 3/4 modesty	<b>laminate</b> tops only	<b>3L-P</b> saddle on walnut <b>4L-P</b> dark mahogany on walnut <b>25M-P</b> mahogany on walnut <b>25B-P</b> ebony on walnut <b>25C-P</b> cherry on walnut <b>2ML-P</b> natural maple <b>3ML-P</b> light maple <b>4ML-P</b> medium maple <b>5ML-P</b> cherry on maple <b>6LC-P</b> light cherry on cherry <b>7MC-P</b> medium cherry on cherry <b>8DC-P</b> dark cherry on cherry	<b>veneer</b> top and chassis finish	<b>3L-W</b> saddle on walnut <b>2KL-W</b> sepia on walnut <b>4L-W</b> dark mahogany on walnut <b>25M-W</b> mahogany on walnut <b>25B-W</b> ebony on walnut <b>25C-W</b> cherry on walnut <b>2ML-W</b> natural maple <b>3ML-W</b> light maple <b>4ML-W</b> medium maple <b>5ML-W</b> cherry on maple <b>6LC-W</b> light cherry on cherry <b>1NC-W</b> natural cherry on cherry <b>2HC-W</b> honey cherry on cherry	<b>7MC-W</b> medium cherry on cherry <b>8DC-W</b> dark cherry on cherry <b>9BC-W</b> burgundy cherry on cherry
---------------------------------------	------------------------------	---	---	---	--

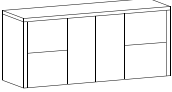
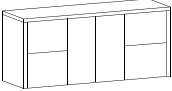
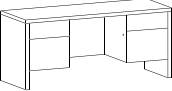
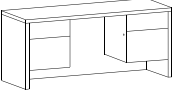
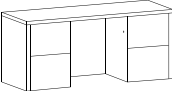
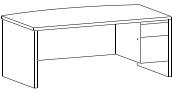
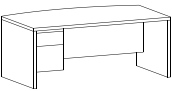
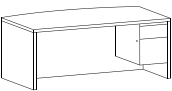
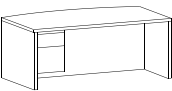
	model number	description	d	w	h	freight	list \$ zone 1	list \$ zone 2
	<b>CR2366D-FP</b> - _ - _ - _ <b>CR2166D-FP</b> - _ - _ - _	storage credenza left and right file/file pedestals double hinged door center one adjustable shelf  <i>ADDITIONAL SHELVES (EACH) \$92</i> <i>SOLID WOOD SHELVES (EACH) \$434</i>	20	66	29	class 125 cwt 235 lb cu ft 26	<b>3,215 W</b>  <b>2,816 P</b>	<b>3,469 W</b>  <b>3,028 P</b>
	<b>CR236624D-FP</b> - _ - _ - _ - _ <b>CR216624D-FP</b> - _ - _ - _ - _	storage credenza left and right file/file pedestals double hinged door center one adjustable shelf  <i>ADDITIONAL SHELVES (EACH) \$92</i> <i>SOLID WOOD SHELVES (EACH) \$434</i>	24	66	29	class 125 cwt 235 lb cu ft 26	<b>3,383 W</b>  <b>3,201 P</b>	<b>3,654 W</b>  <b>3,456 P</b>
	<b>CR236624-3Q</b> - _ - _ - _ <b>CR216624-3Q</b> - _ - _ - _	kneespace credenza left and right box/file pedestals	24	66	29 <i>KNEESPACE: 34"</i>	class 125 cwt 225 lb cu ft 30	<b>2,717 W</b>  <b>2,495 P</b>	<b>2,935 W</b>  <b>2,685 P</b>
	<b>CR236624-FM</b> - _ - _ - _ <b>CR216624-FM</b> - _ - _ - _	kneespace credenza left and right box/file pedestals	24	66	29 <i>KNEESPACE: 34"</i>	class 125 cwt 245 lb cu ft 30	<b>2,814 W</b>  <b>2,625 P</b>	<b>3,041 W</b>  <b>2,814 P</b>
	<b>CR236624-FP</b> - _ - _ - _ <b>CR216624-FP</b> - _ - _ - _	kneespace credenza left and right file/file pedestals	24	66	29 <i>KNEESPACE: 34"</i>	class 125 cwt 270 lb cu ft 30	<b>2,971 W</b>  <b>2,892 P</b>	<b>3,245 W</b>  <b>3,209 P</b>
	<b>DBT2372R-3Q</b> - _ - _ - _ <b>DBT2172R-3Q</b> - _ - _ - _	bow front single pedestal desk right box/file pedestal pull out slide	42	72	29	class 125 cwt 270 lb cu ft 55	<b>4,617 W</b>  <b>3,922 P</b>	<b>4,986 W</b>  <b>4,238 P</b>
	<b>DBT2372L-3Q</b> - _ - _ - _ <b>DBT2172L-3Q</b> - _ - _ - _	bow front single pedestal desk left box/file pedestal pull out slide	42	72	29	class 125 cwt 270 lb cu ft 55	<b>4,617 W</b>  <b>3,922 P</b>	<b>4,986 W</b>  <b>4,238 P</b>
	<b>DBT2372R-FM</b> - _ - _ - _ <b>DBT2172R-FM</b> - _ - _ - _	bow front single pedestal desk right box/file pedestal pull out slide	42	72	29	class 125 cwt 275 lb cu ft 55	<b>4,749 W</b>  <b>4,045 P</b>	<b>5,129 W</b>  <b>4,369 P</b>
	<b>DBT2372L-FM</b> - _ - _ - _ <b>DBT2172L-FM</b> - _ - _ - _	bow front single pedestal desk left box/file pedestal pull out slide	42	72	29	class 125 cwt 275 lb cu ft 55	<b>4,749 W</b>  <b>4,045 P</b>	<b>5,129 W</b>  <b>4,369 P</b>

top

laminat  
topveneer top

\$138 list upcharge for putting any additional pulls on a  
2300/2100 unit → allegro → forte → presto



ovation/bravo | 2300 series  
2100 series

| wood top, veneer chassis, veneer drawer fronts  
| laminate top, veneer chassis, veneer drawer fronts



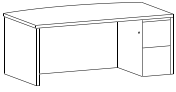
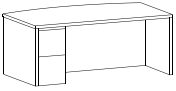
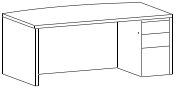
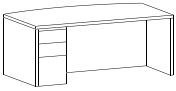
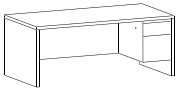
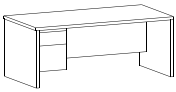
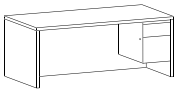
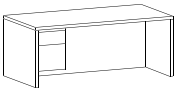
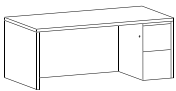

ovation/bravo  
2300/2100

	model number	description		freight	list \$ zone 1	zone 2
	<b>DBT2372R-FP</b> - _ - _ - _ <b>DBT2172R-FP</b> - _ - _ - _	bow front single pedestal desk right file/file pedestal pull out slide	42 72 29	class 125 cwt 295 lb cu ft 55	<b>4,957 W</b> <b>4,201 P</b>	<b>5,354 W</b> <b>4,537 P</b>
	<b>DBT2372L-FP</b> - _ - _ - _ <b>DBT2172L-FP</b> - _ - _ - _	bow front single pedestal desk left file/file pedestal pull out slide	42 72 29	class 125 cwt 295 lb cu ft 55	<b>4,957 W</b> <b>4,201 P</b>	<b>5,354 W</b> <b>4,537 P</b>
	<b>DBT2372R-FP3D</b> - _ - _ - _ <b>DBT2172R-FP3D</b> - _ - _ - _	bow front single pedestal desk right box/box/file pedestal pull out slide	42 72 29	class 125 cwt 295 lb cu ft 55	<b>5,226 W</b> <b>4,684 P</b>	<b>5,646 W</b> <b>5,059 P</b>
	<b>DBT2372L-FP3D</b> - _ - _ - _ <b>DBT2172L-FP3D</b> - _ - _ - _	bow front single pedestal desk left box/box/file pedestal pull out slide	42 72 29	class 125 cwt 295 lb cu ft 55	<b>5,226 W</b> <b>4,684 P</b>	<b>5,646 W</b> <b>5,059 P</b>
	<b>D2372R-3Q</b> - _ - _ - _ <b>D2172R-3Q</b> - _ - _ - _	single pedestal desk right box/file pedestal pull out slide	36 72 29	class 125 cwt 265 lb cu ft 53	<b>2,935 W</b> <b>2,387 P</b>	<b>3,170 W</b> <b>2,514 P</b>
	<b>D2372L-3Q</b> - _ - _ - _ <b>D2172L-3Q</b> - _ - _ - _	single pedestal desk left box/file pedestal pull out slide	36 72 29	class 125 cwt 265 lb cu ft 53	<b>2,935 W</b> <b>2,387 P</b>	<b>3,170 W</b> <b>2,514 P</b>
[ QS ] 	<b>D2372R-FM</b> - _ - _ - _ <b>D2172R-FM</b> - _ - _ - _ Quick Ship available in 8DC dark cherry with B edge	single pedestal desk right box/file pedestal pull out slide	36 72 29	class 125 cwt 270 lb cu ft 53	<b>3,067 W</b> <b>2,470 P</b>	<b>3,313 W</b> <b>2,670 P</b>
[ QS ] 	<b>D2372L-FM</b> - _ - _ - _ <b>D2172L-FM</b> - _ - _ - _ Quick Ship available in 8DC dark cherry with B edge	single pedestal desk left box/file pedestal pull out slide	36 72 29	class 125 cwt 270 lb cu ft 53	<b>3,067 W</b> <b>2,470 P</b>	<b>3,313 W</b> <b>2,670 P</b>
	<b>D2372R-FP</b> - _ - _ - _ <b>D2172R-FP</b> - _ - _ - _	single pedestal desk right file/file pedestal pull out slide	36 72 29	class 125 cwt 290 lb cu ft 53	<b>3,274 W</b> <b>2,664 P</b>	<b>3,536 W</b> <b>2,878 P</b>

**chassis models**

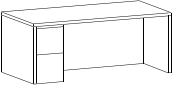
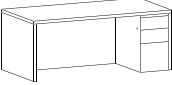
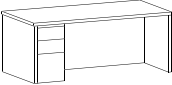
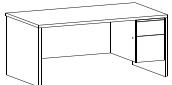
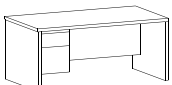
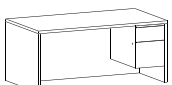
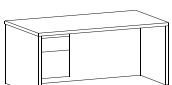
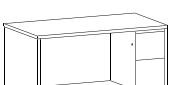
<b>3Q</b> 3/4 pedestal 3/4 modesty	<b>laminate</b> tops only	<b>3L-P</b> saddle on walnut <b>4L-P</b> dark mahogany on walnut <b>25M-P</b> mahogany on walnut <b>25B-P</b> ebony on walnut <b>25C-P</b> cherry on walnut <b>2ML-P</b> natural maple <b>3ML-P</b> light maple <b>4ML-P</b> medium maple <b>5ML-P</b> cherry on maple <b>6LC-P</b> light cherry on cherry <b>7MC-P</b> medium cherry on cherry <b>8DC-P</b> dark cherry on cherry	<b>veneer</b> top and chassis finish	<b>3L-W</b> saddle on walnut <b>2KL-W</b> sepia on walnut <b>4L-W</b> dark mahogany on walnut <b>25M-W</b> mahogany on walnut <b>25B-W</b> ebony on walnut <b>25C-W</b> cherry on walnut <b>2ML-W</b> natural maple <b>3ML-W</b> light maple <b>4ML-W</b> medium maple <b>5ML-W</b> cherry on maple <b>6LC-W</b> light cherry on cherry <b>1NC-W</b> natural cherry on cherry <b>2HC-W</b> honey cherry on cherry	<b>7MC-W</b> medium cherry on cherry <b>8DC-W</b> dark cherry on cherry <b>9BC-W</b> burgundy cherry on cherry
---------------------------------------	------------------------------	---	---	---	--

	model number	description	d	w	h	freight	list \$ zone 1	list \$ zone 2
	<b>D2372L-FP</b> - _ - _ - _ <b>D2172L-FP</b> - _ - _ - _	single pedestal desk left file/file pedestal pull out slide	36	72	29	class 125 cwt 290 lb cu ft 53	<b>3,274 W</b> <b>2,664 P</b>	<b>3,536 W</b> <b>2,878 P</b>
	<b>D2372R-FP3D</b> - _ - _ - _ <b>D2172R-FP3D</b> - _ - _ - _	single pedestal desk right box/box/file pedestal pull out slide	36	72	29	class 125 cwt 290 lb cu ft 53	<b>3,545 W</b> <b>2,935 P</b>	<b>3,828 W</b> <b>3,168 P</b>
	<b>D2372L-FP3D</b> - _ - _ - _ <b>D2172L-FP3D</b> - _ - _ - _	single pedestal desk left box/box/file pedestal pull out slide	36	72	29	class 125 cwt 290 lb cu ft 53	<b>3,545 W</b> <b>2,935 P</b>	<b>3,828 W</b> <b>3,168 P</b>
	<b>D2366R-3Q</b> - _ - _ - _ <b>D2166R-3Q</b> - _ - _ - _	single pedestal desk right box/file pedestal pull out slide	36	66	29	class 125 cwt 255 lb cu ft 48	<b>2,778 W</b> <b>2,323 P</b>	<b>3,003 W</b> <b>2,508 P</b>
	<b>D2366L-3Q</b> - _ - _ - _ <b>D2166L-3Q</b> - _ - _ - _	single pedestal desk left box/file pedestal pull out slide	36	66	29	class 125 cwt 255 lb cu ft 48	<b>2,778 W</b> <b>2,323 P</b>	<b>3,003 W</b> <b>2,508 P</b>
	<b>D2366R-FM</b> - _ - _ - _ <b>D2166R-FM</b> - _ - _ - _	single pedestal desk right box/file pedestal pull out slide	36	66	29	class 125 cwt 260 lb cu ft 48	<b>2,907 W</b> <b>2,341 P</b>	<b>3,139 W</b> <b>2,528 P</b>
	<b>D2366L-FM</b> - _ - _ - _ <b>D2166L-FM</b> - _ - _ - _	single pedestal desk left box/file pedestal pull out slide	36	66	29	class 125 cwt 260 lb cu ft 48	<b>2,907 W</b> <b>2,341 P</b>	<b>3,139 W</b> <b>2,528 P</b>
	<b>D2366R-FP</b> - _ - _ - _ <b>D2166R-FP</b> - _ - _ - _	single pedestal desk right file/file pedestal pull out slide	36	66	29	class 125 cwt 280 lb cu ft 48	<b>3,086 W</b> <b>2,636 P</b>	<b>3,331 W</b> <b>2,847 P</b>
	<b>D2366L-FP</b> - _ - _ - _ <b>D2166L-FP</b> - _ - _ - _	single pedestal desk left file/file pedestal pull out slide	36	66	29	class 125 cwt 280 lb cu ft 48	<b>3,086 W</b> <b>2,636 P</b>	<b>3,331 W</b> <b>2,847 P</b>

top

laminat  
topvener top

\$138 list upcharge for putting any additional pulls on a  
2300/2100 unit → allegro → forte → presto



ovation/bravo | 2300 series | wood top, veneer chassis, veneer drawer fronts  
 2100 series | laminate top, veneer chassis, veneer drawer fronts



ovation/bravo  
2300/2100

	model number	description		freight	list \$ zone 1	zone 2
	D2366R-FP3D - _ - _ - _	single pedestal desk right box/box/file pedestal pull out slide	36 66 29	class 125 cwt 280 lb cu ft 48	<b>3,337 W</b>	<b>3,606 W</b>
	D2166R-FP3D - _ - _ - _				<b>2,803 P</b>	<b>3,102 P</b>
	D2366L-FP3D - _ - _ - _	single pedestal desk left box/box/file pedestal pull out slide	36 66 29	class 125 cwt 280 lb cu ft 48	<b>3,337 W</b>	<b>3,606 W</b>
	D2166L-FP3D - _ - _ - _				<b>2,803 P</b>	<b>3,102 P</b>
	D236630R-3Q - _ - _ - _	single pedestal desk right box/file pedestal pull out slide	30 66 29	class 125 cwt 240 lb cu ft 40	<b>2,367 W</b>	<b>2,593 W</b>
	D216630R-3Q - _ - _ - _				<b>1,951 P</b>	<b>2,106 P</b>
	D236630L-3Q - _ - _ - _	single pedestal desk left box/file pedestal pull out slide	30 66 29	class 125 cwt 240 lb cu ft 40	<b>2,367 W</b>	<b>2,593 W</b>
	D216630L-3Q - _ - _ - _				<b>1,951 P</b>	<b>2,106 P</b>
	D236630R-FM - _ - _ - _	single pedestal desk right box/file pedestal pull out slide	30 66 29	class 125 cwt 245 lb cu ft 40	<b>2,398 W</b>	<b>2,591 W</b>
	D216630R-FM - _ - _ - _				<b>1,980 P</b>	<b>2,138 P</b>
	D236630L-FM - _ - _ - _	single pedestal desk left box/file pedestal pull out slide	30 66 29	class 125 cwt 245 lb cu ft 40	<b>2,398 W</b>	<b>2,591 W</b>
	D216630L-FM - _ - _ - _				<b>1,980 P</b>	<b>2,138 P</b>
	D236630R-FP - _ - _ - _	single pedestal desk right file/file pedestal pull out slide	30 66 29	class 125 cwt 265 lb cu ft 40	<b>2,939 W</b>	<b>3,174 W</b>
	D216630R-FP - _ - _ - _				<b>2,196 P</b>	<b>2,370 P</b>
	D236630L-FP - _ - _ - _	single pedestal desk left file/file pedestal pull out slide	30 66 29	class 125 cwt 265 lb cu ft 40	<b>2,939 W</b>	<b>3,174 W</b>
	D216630L-FP - _ - _ - _				<b>2,196 P</b>	<b>2,370 P</b>
	D236630R-FP3D - _ - _ - _	single pedestal desk right box/box/file pedestal pull out slide	30 66 29	class 125 cwt 265 lb cu ft 40	<b>3,086 W</b>	<b>3,331 W</b>
	D216630R-FP3D - _ - _ - _				<b>2,304 P</b>	<b>2,490 P</b>

**chassis models**

<p><b>3Q</b> 3/4 pedestal 3/4 modesty</p> <p><b>FM</b> 3/4 pedestal full modesty</p> <p><b>FP</b> full pedestal full modesty</p>	<p><b>laminate</b> tops only</p> <p><b>3L-P</b> saddle on walnut <b>4L-P</b> dark mahogany on walnut <b>25M-P</b> mahogany on walnut <b>25B-P</b> ebony on walnut <b>25C-P</b> cherry on walnut <b>2ML-P</b> natural maple <b>3ML-P</b> light maple <b>4ML-P</b> medium maple <b>5ML-P</b> cherry on maple <b>6LC-P</b> light cherry on cherry <b>7MC-P</b> medium cherry on cherry <b>8DC-P</b> dark cherry on cherry</p>	<p><b>veneer</b> top and chassis finish</p> <p><b>3L-W</b> saddle on walnut <b>2KL-W</b> sepia on walnut <b>4L-W</b> dark mahogany on walnut <b>25M-W</b> mahogany on walnut <b>25B-W</b> ebony on walnut <b>25C-W</b> cherry on walnut <b>2ML-W</b> natural maple <b>3ML-W</b> light maple <b>4ML-W</b> medium maple <b>5ML-W</b> cherry on maple <b>6LC-W</b> light cherry on cherry <b>1NC-W</b> natural cherry on cherry <b>2HC-W</b> honey cherry on cherry</p>	<p><b>7MC-W</b> medium cherry on cherry <b>8DC-W</b> dark cherry on cherry <b>9BC-W</b> burgundy cherry on cherry</p>
--	--	--	---

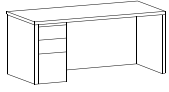
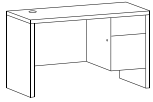
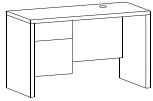
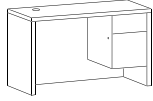
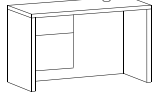
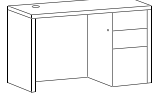
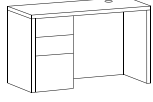
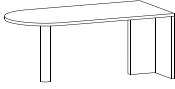
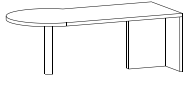
	model number	description	d	w	h	freight	list \$ zone 1	list \$ zone 2
	D236630L-FP3D - _ - _ - _ - D216630L-FP3D - _ - _ - _ -	single pedestal desk left box/box/file pedestal pull out slide	30	66	29	class 125 cwt 265 lb cu ft 40	3,086 W  2,304 P	3,331 W  2,490 P
	D2348R-3Q - _ - _ - _ D2148R-3Q - _ - _ - _	single pedestal desk right box/file pedestal grommet in top for wire management	24	48	29	class 125 cwt 170 lb cu ft 24	2,006 W  1,495 P	2,164 W  1,617 P
	D2348L-3Q - _ - _ - _ D2148L-3Q - _ - _ - _	single pedestal desk left box/file pedestal grommet in top for wire management	24	48	29	class 125 cwt 170 lb cu ft 24	2,006 W  1,495 P	2,164 W  1,617 P
	D2348R-FM - _ - _ - _ D2148R-FM - _ - _ - _	single pedestal desk right box/file pedestal grommet in top for wire management	24	48	29	class 125 cwt 175 lb cu ft 24	2,110 W  1,528 P	2,278 W  1,649 P
	D2348L-FM - _ - _ - _ D2148L-FM - _ - _ - _	single pedestal desk left box/file pedestal grommet in top for wire management	24	48	29	class 125 cwt 175 lb cu ft 24	2,110 W  1,528 P	2,278 W  1,649 P
	D2348R-FP - _ - _ - _ D2148R-FP - _ - _ - _	single pedestal desk right box/box/file pedestal grommet in top for wire management	24	48	29	class 125 cwt 225 lb cu ft 24	2,514 W  1,762 P	2,714 W  1,902 P
	D2348L-FP - _ - _ - _ D2148L-FP - _ - _ - _	single pedestal desk left box/box/file pedestal grommet in top for wire management	24	48	29	class 125 cwt 225 lb cu ft 24	2,514 W  1,762 P	2,714 W  1,902 P
	BT2372 - _ - _ - _ BT2172 - _ - _ - _	bullet top "T" support end black metal support column  <i>MODESTY \$218 UPCHARGE</i>	36	72	29	class 125 cwt 170 lb cu ft 23	4,100 W  3,252 P	4,430 W  3,512 P
	PT2384R - _ - _ - _ PT2184R - _ - _ - _	p-top "T" support end black metal support column  <i>MODESTY \$218 UPCHARGE</i>	42	84	29	class 125 cwt 177 lb cu ft 23	4,226 W  3,669 P	4,565 W  3,964 P

**top**

laminat  
topveneer top

\$217 list upcharge for (TH) Typing Height

\$138 list upcharge for putting any additional pulls on a  
2300/2100 unit → allegro → forte → presto



ovation/bravo | 2300 series  
2100 series

| wood top, veneer chassis, veneer drawer fronts  
| laminate top, veneer chassis, veneer drawer fronts

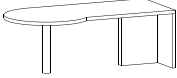
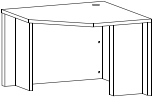
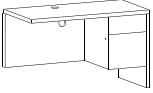
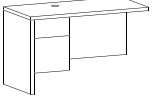
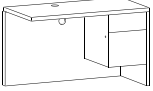
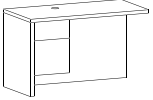
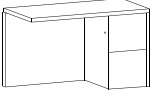
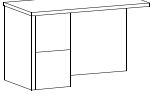
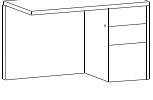

ovation/bravo  
2300/2100

	model number	description		freight	list \$ zone 1	zone 2
	<b>PT2384L</b> - - - - -	p-top "T" support end black metal support column	42 84 29	class 125 cwt 177 lb cu ft 23	<b>4,226 W</b>	<b>4,565 W</b>
	<b>PT2184L</b> - - - - -	<i>MODESTY \$218 UPCHARGE</i>			<b>3,669 P</b>	<b>3,964 P</b>
	<b>CU2342</b> - - - - -	corner unit grommet	42 42 29	class 85 kd cwt 188 lb cu ft 7	<b>2,410 W</b>	<b>2,603 W</b>
	<b>CU2142</b> - - - - -	<i>USE A 24" RETURN</i>			<b>1,863 P</b>	<b>2,011 P</b>
	<b>R2324R-3Q</b> - - - - -	single pedestal return right box/file pedestal	24 48 29	class 125 cwt 150 lb cu ft 23	<b>1,514 W</b>	<b>1,601 W</b>
	<b>R2124R-3Q</b> - - - - -	<i>FOR USE ONLY WITH 42" CORNER UNIT</i>			<b>1,344 P</b>	<b>1,448 P</b>
	<b>R2324L-3Q</b> - - - - -	single pedestal return left box/file pedestal	24 48 29	class 125 cwt 150 lb cu ft 23	<b>1,514 W</b>	<b>1,601 W</b>
	<b>R2124L-3Q</b> - - - - -	<i>FOR USE ONLY WITH 42" CORNER UNIT</i>			<b>1,344 P</b>	<b>1,448 P</b>
[ QS ] 	<b>R2324R-FM</b> - - - - -	single pedestal return right box/file pedestal	24 48 29	class 125 cwt 155 lb cu ft 23	<b>1,586 W</b>	<b>1,715 W</b>
	<b>R2124R-FM</b> - - - - -	<i>FOR USE ONLY WITH 42" CORNER UNIT</i> Quick Ship available in 8DC dark cherry with B edge			<b>1,389 P</b>	<b>1,500 P</b>
[ QS ] 	<b>R2324L-FM</b> - - - - -	single pedestal return left box/file pedestal	24 48 29	class 125 cwt 155 lb cu ft 23	<b>1,586 W</b>	<b>1,715 W</b>
	<b>R2124L-FM</b> - - - - -	<i>FOR USE ONLY WITH 42" CORNER UNIT</i> Quick Ship available in 8DC dark cherry with B edge			<b>1,389 P</b>	<b>1,500 P</b>
	<b>R2324R-2D</b> - - - - -	single pedestal return right file/file pedestal	24 48 29	class 125 cwt 175 lb cu ft 23	<b>1,693 W</b>	<b>1,836 W</b>
	<b>R2124R-2D</b> - - - - -	<i>FOR USE ONLY WITH 42" CORNER UNIT</i>			<b>1,413 P</b>	<b>1,533 P</b>
	<b>R2324L-2D</b> - - - - -	single pedestal return left file/file pedestal	24 48 29	class 125 cwt 175 lb cu ft 23	<b>1,693 W</b>	<b>1,836 W</b>
	<b>R2124L-2D</b> - - - - -	<i>FOR USE ONLY WITH 42" CORNER UNIT</i>			<b>1,413 P</b>	<b>1,533 P</b>
	<b>R2324R-3D</b> - - - - -	single pedestal return right box/box/file pedestal	24 48 29	class 125 cwt 175 lb cu ft 23	<b>1,777 W</b>	<b>1,922 W</b>
	<b>R2124R-3D</b> - - - - -	<i>FOR USE ONLY WITH 42" CORNER UNIT</i>			<b>1,497 P</b>	<b>1,618 P</b>

**chassis models**

<b>3Q</b> 3/4 pedestal 3/4 modesty	<b>laminate</b> tops only	<b>3L-P</b> saddle on walnut <b>4L-P</b> dark mahogany on walnut <b>25M-P</b> mahogany on walnut <b>25B-P</b> ebony on walnut <b>25C-P</b> cherry on walnut <b>2ML-P</b> natural maple <b>3ML-P</b> light maple <b>4ML-P</b> medium maple <b>5ML-P</b> cherry on maple <b>6LC-P</b> light cherry on cherry <b>7MC-P</b> medium cherry on cherry <b>8DC-P</b> dark cherry on cherry	<b>veneer</b> top and chassis finish	<b>3L-W</b> saddle on walnut <b>2KL-W</b> sepia on walnut <b>4L-W</b> dark mahogany on walnut <b>25M-W</b> mahogany on walnut <b>25B-W</b> ebony on walnut <b>25C-W</b> cherry on walnut <b>2ML-W</b> natural maple <b>3ML-W</b> light maple <b>4ML-W</b> medium maple <b>5ML-W</b> cherry on maple <b>6LC-W</b> light cherry on cherry <b>1NC-W</b> natural cherry on cherry <b>2HC-W</b> honey cherry on cherry	<b>7MC-W</b> medium cherry on cherry <b>8DC-W</b> dark cherry on cherry <b>9BC-W</b> burgundy cherry on cherry
---------------------------------------	------------------------------	---	---	---	--



## FBT2372-3Q-3L-W-E

unit identification (type), top dimension, chassis option - chassis & top finish - top material - edge option

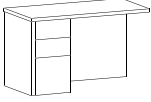
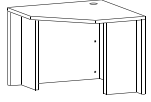
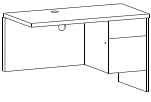
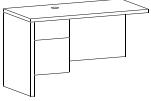
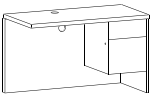
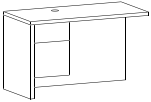
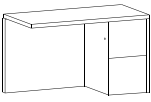
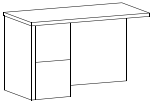
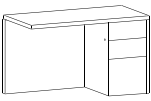
	model number	description	d	w	h	freight	list \$ zone 1	list \$ zone 2
	R2324L-3D - _ _ _ _	single pedestal return left box/box/file pedestal	24	48	29	class 125 cwt 175 lb cu ft 23	1,777 W	1,922 W
	R2124L-3D - _ _ _ _	<i>FOR USE ONLY WITH 42" CORNER UNIT</i>					1,497 P	1,618 P
	CU2338 - _ _ _ _	corner unit grommet	38	38	29	class 85 kd cwt 100 lb cu ft 7	2,054 W	2,221 W
	CU2138 - _ _ _ _	<i>USE A 20" RETURN</i>					1,686 P	1,822 P
	R2320R-3Q - _ _ _ _	single pedestal return right box/file pedestal	20	48	29	class 125 cwt 150 lb cu ft 23	1,514 W	1,601 W
	R2120R-3Q - _ _ _ _	<i>FOR USE ONLY WITH 38" CORNER UNIT</i>					1,344 P	1,448 P
	R2320L-3Q - _ _ _ _	single pedestal return left box/file pedestal	20	48	29	class 125 cwt 150 lb cu ft 23	1,514 W	1,601 W
	R2120L-3Q - _ _ _ _	<i>FOR USE ONLY WITH 38" CORNER UNIT</i>					1,344 P	1,448 P
	R2320R-FM - _ _ _ _	single pedestal return right box/file pedestal	20	48	29	class 125 cwt 155 lb cu ft 23	1,586 W	1,715 W
	R2120R-FM - _ _ _ _	<i>FOR USE ONLY WITH 38" CORNER UNIT</i>					1,389 P	1,500 P
	R2320L-FM - _ _ _ _	single pedestal return left box/file pedestal	20	48	29	class 125 cwt 155 lb cu ft 23	1,586 W	1,715 W
	R2120L-FM - _ _ _ _	<i>FOR USE ONLY WITH 38" CORNER UNIT</i>					1,389 P	1,500 P
	R2320R-2D - _ _ _ _	single pedestal return right file/file pedestal	20	48	29	class 125 cwt 175 lb cu ft 23	1,693 W	1,836 W
	R2120R-2D - _ _ _ _	<i>FOR USE ONLY WITH 38" CORNER UNIT</i>					1,413 P	1,533 P
	R2320L-2D - _ _ _ _	single pedestal return left file/file pedestal	20	48	29	class 125 cwt 175 lb cu ft 23	1,693 W	1,836 W
	R2120L-2D - _ _ _ _	<i>FOR USE ONLY WITH 38" CORNER UNIT</i>					1,413 P	1,533 P
	R2320R-3D - _ _ _ _	single pedestal return right box/box/file pedestal	20	48	29	class 125 cwt 175 lb cu ft 23	1,777 W	1,922 W
	R2120R-3D - _ _ _ _	<i>FOR USE ONLY WITH 38" CORNER UNIT</i>					1,497 P	1,618 P

top

laminat  
topvener top

\$217 list upcharge for (TH) Typing Height

\$138 list upcharge for putting any additional pulls on a  
2300/2100 unit → allegro → forte → presto



ovation/bravo | 2300 series  
2100 series

| wood top, veneer chassis, veneer drawer fronts  
| laminate top, veneer chassis, veneer drawer fronts



ovation/bravo  
2300/2100

	model number	description		freight	list \$ zone 1	zone 2
	R2320L-3D - - - - -	single pedestal return left box/box/file pedestal	20 48 29	class 125 cwt 175 lb cu ft 23	1,777 W	1,922 W
	R2120L-3D - - - - -	<i>FOR USE ONLY WITH 38" CORNER UNIT</i>			1,497 P	1,618 P
	R2348R-EH3Q - - - - -	single pedestal return right box/file pedestal	24 48 29	class 125 cwt 150 lb cu ft 23	1,514 W	1,601 W
	R2148R-EH3Q - - - - -	<i>FOR USE WITH ANY SINGLE PEDESTAL DESK OR CREDENZA</i>			1,344 P	1,448 P
	R2348L-EH3Q - - - - -	single pedestal return left box/file pedestal	24 48 29	class 125 cwt 150 lb cu ft 23	1,514 W	1,601 W
	R2148L-EH3Q - - - - -	<i>FOR USE WITH ANY SINGLE PEDESTAL DESK OR CREDENZA</i>			1,344 P	1,448 P
	R2348R-EHFM - - - - -	single pedestal return right box/file pedestal	24 48 29	class 125 cwt 155 lb cu ft 23	1,586 W	1,715 W
	R2148R-EHFM - - - - -	<i>FOR USE WITH ANY SINGLE PEDESTAL DESK OR CREDENZA</i>			1,389 P	1,500 P
	R2348L-EFHM - - - - -	single pedestal return left box/file pedestal	24 48 29	class 125 cwt 155 lb cu ft 23	1,586 W	1,715 W
	R2148L-EFHM - - - - -	<i>FOR USE WITH ANY SINGLE PEDESTAL DESK OR CREDENZA</i>			1,389 P	1,500 P
	R2348R-EHFP - - - - -	single pedestal return right box/box/file pedestal	24 48 29	class 125 cwt 175 lb cu ft 23	1,777 W	1,922 W
	R2148R-EHFP - - - - -	<i>FOR USE WITH ANY SINGLE PEDESTAL DESK OR CREDENZA</i>			1,497 P	1,618 P
	R2348L-EHFP - - - - -	single pedestal return left box/box/file pedestal	24 48 29	class 125 cwt 175 lb cu ft 23	1,777 W	1,922 W
	R2148L-EHFP - - - - -	<i>FOR USE WITH ANY SINGLE PEDESTAL DESK OR CREDENZA</i>			1,497 P	1,618 P
	R2348R-2D-EHFP - - -	single pedestal return right file/file pedestal	24 48 29	class 125 cwt 175 lb cu ft 23	1,693 W	1,836 W
	R2148R-2D-EHFP - - -	<i>FOR USE WITH ANY SINGLE PEDESTAL DESK OR CREDENZA</i>			1,413 P	1,527 P
	R2348L-2D-EHFP - - -	single pedestal return left file/file pedestal	24 48 29	class 125 cwt 175 lb cu ft 23	1,693 W	1,836 W
	R2148L-2D-EHFP - - -	<i>FOR USE WITH ANY SINGLE PEDESTAL DESK OR CREDENZA</i>			1,413 P	1,527 P

**chassis models**

<b>3Q</b> 3/4 pedestal 3/4 modesty	<b>laminate</b> tops only	<b>3L-P</b> saddle on walnut <b>4L-P</b> dark mahogany on walnut <b>25M-P</b> mahogany on walnut <b>25B-P</b> ebony on walnut <b>25C-P</b> cherry on walnut <b>2ML-P</b> natural maple <b>3ML-P</b> light maple <b>4ML-P</b> medium maple <b>5ML-P</b> cherry on maple <b>6LC-P</b> light cherry on cherry <b>7MC-P</b> medium cherry on cherry <b>8DC-P</b> dark cherry on cherry	<b>veneer</b> top and chassis finish	<b>3L-W</b> saddle on walnut <b>2KL-W</b> sepia on walnut <b>4L-W</b> dark mahogany on walnut <b>25M-W</b> mahogany on walnut <b>25B-W</b> ebony on walnut <b>25C-W</b> cherry on walnut <b>2ML-W</b> natural maple <b>3ML-W</b> light maple <b>4ML-W</b> medium maple <b>5ML-W</b> cherry on maple <b>6LC-W</b> light cherry on cherry <b>1NC-W</b> natural cherry on cherry <b>2HC-W</b> honey cherry on cherry	<b>7MC-W</b> medium cherry on cherry <b>8DC-W</b> dark cherry on cherry <b>9BC-W</b> burgundy cherry on cherry
---------------------------------------	------------------------------	---	---	---	--

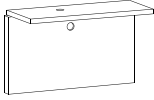
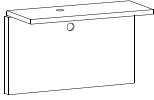
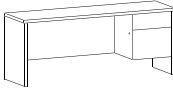
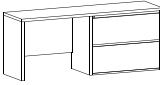
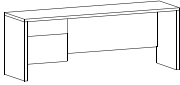
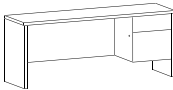
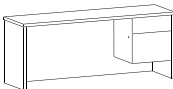
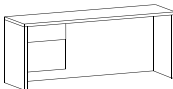
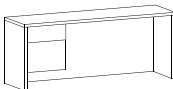
	model number	description	d	w	h	freight	list \$ zone 1	list \$ zone 2
	<b>B2348-EH</b> - - - - -  <b>B2148-EH</b> - - - - -	bridge open kneespace	20	48	29	class 125 kd cwt 65 lb cu ft 6	<b>1,080 W</b>  <b>580 P</b>	<b>1,166 W</b>  <b>628 P</b>
	<b>B234824-EH</b> - - - - -  <b>B214824-EH</b> - - - - -	bridge open kneespace	24	48	29	class 125 kd cwt 65 lb cu ft 6	<b>1,090 W</b>  <b>602 P</b>	<b>1,177 W</b>  <b>649 P</b>
	<b>C2372R-3Q</b> - - - - -  <b>C2172R-3Q</b> - - - - -	single pedestal credenza right box/file pedestal	20	72	29	class 125 cwt 210 lb cu ft 28	<b>1,839 W</b>  <b>1,689 P</b>	<b>1,987 W</b>  <b>1,825 P</b>
	<b>C237224R-3Q</b> - - - - -  <b>C217224R-3Q</b> - - - - -	single pedestal credenza right box/file pedestal	24	72	29	class 125 cwt 210 lb cu ft 28	<b>2,101 W</b>  <b>1,992 P</b>	<b>2,270 W</b>  <b>2,151 P</b>
	<b>C2372L-3Q</b> - - - - -  <b>C2172L-3Q</b> - - - - -	single pedestal credenza left box/file pedestal	20	72	29	class 125 cwt 210 lb cu ft 28	<b>1,839 W</b>  <b>1,689 P</b>	<b>1,987 W</b>  <b>1,825 P</b>
	<b>C237224L-3Q</b> - - - - -  <b>C217224L-3Q</b> - - - - -	single pedestal credenza left box/file pedestal	24	72	29	class 125 cwt 210 lb cu ft 28	<b>2,101 W</b>  <b>1,992 P</b>	<b>2,270 W</b>  <b>2,151 P</b>
	<b>C2372R-FM</b> - - - - -  <b>C2172R-FM</b> - - - - -	single pedestal credenza right box/file pedestal	20	72	29	class 125 cwt 215 lb cu ft 28	<b>2,017 W</b>  <b>1,774 P</b>	<b>2,177 W</b>  <b>1,917 P</b>
	<b>C237224R-FM</b> - - - - -  <b>C217224R-FM</b> - - - - -	single pedestal credenza right box/file pedestal	24	72	29	class 125 cwt 215 lb cu ft 28	<b>2,292 W</b>  <b>2,052 P</b>	<b>2,476 W</b>  <b>2,217 P</b>
	<b>C2372L-FM</b> - - - - -  <b>C2172L-FM</b> - - - - -	single pedestal credenza left box/file pedestal	20	72	29	class 125 cwt 215 lb cu ft 28	<b>2,017 W</b>  <b>1,774 P</b>	<b>2,177 W</b>  <b>1,917 P</b>

**top**

laminat  
topveneer top

\$217 list upcharge for (TH) Typing Height

\$138 list upcharge for putting any additional pulls on a  
2300/2100 unit → allegro → forte → presto



ovation/bravo | 2300 series  
2100 series

| wood top, veneer chassis, veneer drawer fronts  
| laminate top, veneer chassis, veneer drawer fronts

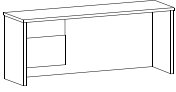
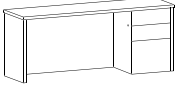
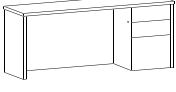
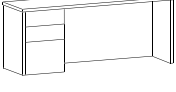
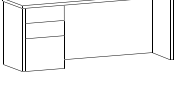
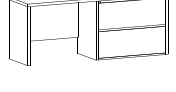
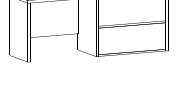
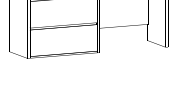
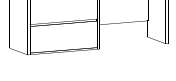

ovation/bravo  
2300/2100

	model number	description		freight	list \$ zone 1	zone 2
	C237224L-FM - _ - _ - _	single pedestal credenza left box/file pedestal	24 72 29	class 125 cwt 215 lb cu ft 28	<b>2,292 W</b>	<b>2,476 W</b>
	C217224L-FM - _ - _ - _				<b>2,052 P</b>	<b>2,217 P</b>
	C2372R-FP - _ - _ - _	single pedestal credenza right box/box/file pedestal	20 72 29	class 125 cwt 225 lb cu ft 28	<b>2,462 W</b>	<b>2,656 W</b>
	C2172R-FP - _ - _ - _				<b>2,155 P</b>	<b>2,327 P</b>
	C237224R-FP - _ - _ - _	single pedestal credenza right box/box/file pedestal	24 72 29	class 125 cwt 225 lb cu ft 28	<b>2,571 W</b>	<b>2,777 W</b>
	C217224R-FP - _ - _ - _				<b>2,444 P</b>	<b>2,640 P</b>
	C2372L-FP - _ - _ - _	single pedestal credenza left box/box/file pedestal	20 72 29	class 125 cwt 225 lb cu ft 28	<b>2,462 W</b>	<b>2,656 W</b>
	C2172L-FP - _ - _ - _				<b>2,155 P</b>	<b>2,327 P</b>
	C237224L-FP - _ - _ - _	single pedestal credenza left box/box/file pedestal	24 72 29	class 125 cwt 225 lb cu ft 28	<b>2,571 W</b>	<b>2,777 W</b>
	C217224L-FP - _ - _ - _				<b>2,444 P</b>	<b>2,640 P</b>
	C2372R-3Q2F - _ - _ - _	single pedestal credenza right lateral file pedestal	20 72 29	class 125 cwt 290 lb cu ft 28	<b>2,144 W</b>	<b>2,315 W</b>
	C2172R-3Q2F - _ - _ - _				<b>2,092 P</b>	<b>2,259 P</b>
	C237224R-3Q2F - _ - _ - _	single pedestal credenza right lateral file pedestal	24 72 29	class 125 cwt 290 lb cu ft 28	<b>2,406 W</b>	<b>2,598 W</b>
	C217224R-3Q2F - _ - _ - _				<b>2,370 P</b>	<b>2,561 P</b>
	C2372L-3Q2F - _ - _ - _	single pedestal credenza left lateral file pedestal	20 72 29	class 125 cwt 290 lb cu ft 28	<b>2,144 W</b>	<b>2,315 W</b>
	C2172L-3Q2F - _ - _ - _				<b>2,092 P</b>	<b>2,259 P</b>
	C237224L-3Q2F - _ - _ - _	single pedestal credenza left lateral file pedestal	24 72 29	class 125 cwt 290 lb cu ft 28	<b>2,406 W</b>	<b>2,598 W</b>
	C217224L-3Q2F - _ - _ - _				<b>2,370 P</b>	<b>2,561 P</b>

**chassis models**

<b>3Q</b> 3/4 pedestal 3/4 modesty	<b>laminate</b> tops only	<b>3L-P</b> saddle on walnut <b>4L-P</b> dark mahogany on walnut <b>25M-P</b> mahogany on walnut <b>25B-P</b> ebony on walnut <b>25C-P</b> cherry on walnut <b>2ML-P</b> natural maple <b>3ML-P</b> light maple <b>4ML-P</b> medium maple <b>5ML-P</b> cherry on maple <b>6LC-P</b> light cherry on cherry <b>7MC-P</b> medium cherry on cherry <b>8DC-P</b> dark cherry on cherry	<b>veneer</b> top and chassis finish	<b>3L-W</b> saddle on walnut <b>2KL-W</b> sepia on walnut <b>4L-W</b> dark mahogany on walnut <b>25M-W</b> mahogany on walnut <b>25B-W</b> ebony on walnut <b>25C-W</b> cherry on walnut <b>2ML-W</b> natural maple <b>3ML-W</b> light maple <b>4ML-W</b> medium maple <b>5ML-W</b> cherry on maple <b>6LC-W</b> light cherry on cherry <b>1NC-W</b> natural cherry on cherry <b>2HC-W</b> honey cherry on cherry	<b>7MC-W</b> medium cherry on cherry <b>8DC-W</b> dark cherry on cherry <b>9BC-W</b> burgundy cherry on cherry
---------------------------------------	------------------------------	---	---	---	--

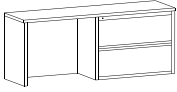
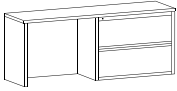
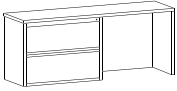
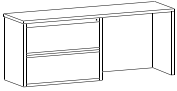
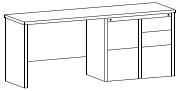
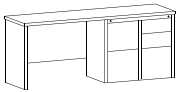
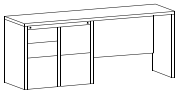
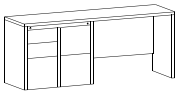
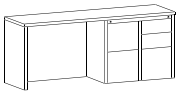
	model number	description	d	w	h	freight	list \$ zone 1	list \$ zone 2
	<b>C2372R-FM2F</b> - _ - _ - <b>C2172R-FM2F</b> - _ - _ -	single pedestal credenza right lateral file pedestal	20	72	29	class 125 cwt 295 lb cu ft 28	<b>2,317 W</b>  <b>2,201 P</b>	<b>2,502 W</b>  <b>2,379 P</b>
	<b>C237224R-FM2F</b> - _ - _ - - _ - <b>C217224R-FM2F</b> - _ - _ - - _ -	single pedestal credenza right lateral file pedestal	24	72	29	class 125 cwt 295 lb cu ft 28	<b>2,594 W</b>  <b>2,481 P</b>	<b>2,802 W</b>  <b>2,679 P</b>
	<b>C2372L-FM2F</b> - _ - _ - <b>C2172L-FM2F</b> - _ - _ -	single pedestal credenza left lateral file pedestal	20	72	29	class 125 cwt 295 lb cu ft 28	<b>2,317 W</b>  <b>2,201 P</b>	<b>2,502 W</b>  <b>2,379 P</b>
	<b>C237224L-FM2F</b> - _ - _ - - _ - <b>C217224L-FM2F</b> - _ - _ - - _ -	single pedestal credenza left lateral file pedestal	24	72	29	class 125 cwt 295 lb cu ft 28	<b>2,594 W</b>  <b>2,481 P</b>	<b>2,802 W</b>  <b>2,679 P</b>
	<b>C2372R-3Q5D</b> - _ - _ - <b>C2172R-3Q5D</b> - _ - _ -	single pedestal credenza left multi-file pedestal	20	72	29	class 125 cwt 290 lb cu ft 28	<b>2,458 W</b>  <b>2,341 P</b>	<b>2,655 W</b>  <b>2,529 P</b>
	<b>C237224R-3Q5D</b> - _ - _ - - _ - <b>C217224R-3Q5D</b> - _ - _ - - _ -	single pedestal credenza right multi-file pedestal	24	72	29	class 125 cwt 290 lb cu ft 28	<b>2,720 W</b>  <b>2,620 P</b>	<b>2,938 W</b>  <b>2,831 P</b>
	<b>C2372L-3Q5D</b> - _ - _ - <b>C2172L-3Q5D</b> - _ - _ -	single pedestal credenza left multi-file pedestal	20	72	29 <small>KNEESPACE: 18.75"</small>	class 125 cwt 290 lb cu ft 28	<b>2,458 W</b>  <b>2,341 P</b>	<b>2,655 W</b>  <b>2,529 P</b>
	<b>C237224L-3Q5D</b> - _ - _ - - _ - <b>C217224L-3Q5D</b> - _ - _ - - _ -	single pedestal credenza left multi-file pedestal	24	72	29	class 125 cwt 290 lb cu ft 28	<b>2,720 W</b>  <b>2,620 P</b>	<b>2,938 W</b>  <b>2,831 P</b>
	<b>C2372R-FM5D</b> - _ - _ - <b>C2172R-FM5D</b> - _ - _ -	single pedestal credenza right multi-file pedestal	20	72	29	class 125 cwt 295 lb cu ft 28	<b>2,632 W</b>  <b>2,515 P</b>	<b>2,842 W</b>  <b>2,715 P</b>

top

laminat  
topveneer top

\$138 list upcharge for putting any additional pulls on a  
2300/2100 unit → allegro → forte → presto

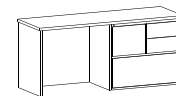

We offer a 4D  
configuration option  
(as shown). For  
information please call  
customer service.



ovation/bravo | 2300 series  
2100 series

| wood top, veneer chassis, veneer drawer fronts  
| laminate top, veneer chassis, veneer drawer fronts

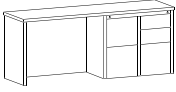
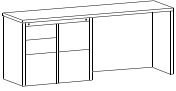
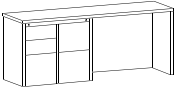
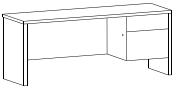
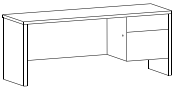
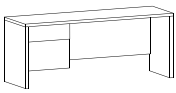
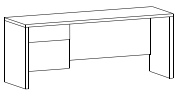
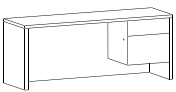
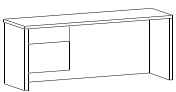

ovation/bravo  
2300/2100

	model number	description		freight	list \$ zone 1	zone 2
	C237224R-FM5D - _ - - - - -	single pedestal credenza right multi-file pedestal	24 72 29	class 125 cwt 295 lb cu ft 28	<b>2,908 W</b>	<b>3,140 W</b>
	C217224R-FM5D - _ - - - - -				<b>2,794 P</b>	<b>3,018 P</b>
	C2372L-FM5D - _ - - - - - - -	single pedestal credenza left multi-file pedestal	20 72 29	class 125 cwt 295 lb cu ft 28	<b>2,632 W</b>	<b>2,842 W</b>
	C2172L-FM5D - _ - - - - - - -				<b>2,515 P</b>	<b>2,715 P</b>
	C237224L-FM5D - _ - - - - -	single pedestal credenza left multi-file pedestal	24 72 29	class 125 cwt 295 lb cu ft 28	<b>2,908 W</b>	<b>3,140 W</b>
	C217224L-FM5D - _ - - - - -				<b>2,794 P</b>	<b>3,018 P</b>
	C2366R-3Q - _ - - - - - - -	single pedestal credenza right box/file pedestal	20 66 29	class 125 cwt 200 lb cu ft 26	<b>1,858 W</b>	<b>2,006 W</b>
	C2166R-3Q - _ - - - - - - -				<b>1,571 P</b>	<b>1,697 P</b>
	C236624R-3Q - _ - - - - - - -	single pedestal credenza right box/file pedestal	24 66 29	class 125 cwt 200 lb cu ft 26	<b>2,123 W</b>	<b>2,292 W</b>
	C216624R-3Q - _ - - - - - - -				<b>1,876 P</b>	<b>2,025 P</b>
	C2366L-3Q - _ - - - - - - -	single pedestal credenza left box/file pedestal	20 66 29	class 125 cwt 200 lb cu ft 26	<b>1,858 W</b>	<b>2,006 W</b>
	C2166L-3Q - _ - - - - - - -				<b>1,571 P</b>	<b>1,697 P</b>
	C236624L-3Q - _ - - - - - - -	single pedestal desk left box/file pedestal	24 66 29	class 125 cwt 200 lb cu ft 26	<b>2,123 W</b>	<b>2,292 W</b>
	C216624L-3Q - _ - - - - - - -				<b>1,876 P</b>	<b>2,025 P</b>
	C2366R-FM - _ - - - - - - -	single pedestal credenza right box/file pedestal	20 66 29	class 125 cwt 205 lb cu ft 26	<b>2,024 W</b>	<b>2,185 W</b>
	C2166R-FM - _ - - - - - - -				<b>1,803 P</b>	<b>1,948 P</b>
	C236624R-FM - _ - - - - - - -	single pedestal credenza right box/file pedestal	24 66 29	class 125 cwt 205 lb cu ft 26	<b>2,299 W</b>	<b>2,483 W</b>
	C216624R-FM - _ - - - - - - -				<b>2,131 P</b>	<b>2,302 P</b>

**chassis models**

<b>3Q</b> 3/4 pedestal 3/4 modesty	<b>laminate</b> tops only	<b>3L-P</b> saddle on walnut <b>4L-P</b> dark mahogany on walnut <b>25M-P</b> mahogany on walnut <b>25B-P</b> ebony on walnut <b>25C-P</b> cherry on walnut <b>2ML-P</b> natural maple <b>3ML-P</b> light maple <b>4ML-P</b> medium maple <b>5ML-P</b> cherry on maple <b>6LC-P</b> light cherry on cherry <b>7MC-P</b> medium cherry on cherry <b>8DC-P</b> dark cherry on cherry	<b>veneer</b> top and chassis finish	<b>3L-W</b> saddle on walnut <b>2KL-W</b> sepia on walnut <b>4L-W</b> dark mahogany on walnut <b>25M-W</b> mahogany on walnut <b>25B-W</b> ebony on walnut <b>25C-W</b> cherry on walnut <b>2ML-W</b> natural maple <b>3ML-W</b> light maple <b>4ML-W</b> medium maple <b>5ML-W</b> cherry on maple <b>6LC-W</b> light cherry on cherry <b>1NC-W</b> natural cherry on cherry <b>2HC-W</b> honey cherry on cherry	<b>7MC-W</b> medium cherry on cherry <b>8DC-W</b> dark cherry on cherry <b>9BC-W</b> burgundy cherry on cherry
---------------------------------------	------------------------------	---	---	---	--

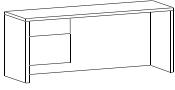
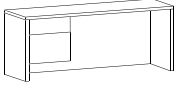
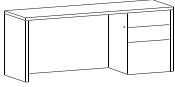
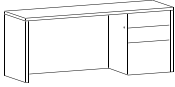
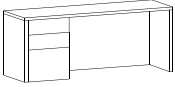
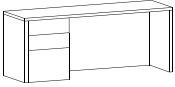
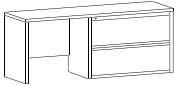
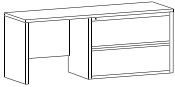
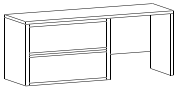
	model number	description	d	w	h	freight	list \$ zone 1	list \$ zone 2
	<b>C2366L-FM</b> - _ - _ - _  <b>C2166L-FM</b> - _ - _ - _	single pedestal credenza left box/file pedestal	20	66	29	class 125 cwt 205 lb cu ft 26	<b>2,024 W</b>  <b>1,803 P</b>	<b>2,185 W</b>  <b>1,948 P</b>
	<b>C236624L-FM</b> - _ - _ - _  <b>C216624L-FM</b> - _ - _ - _	single pedestal credenza left box/file pedestal	24	66	29	class 125 cwt 205 lb cu ft 26	<b>2,299 W</b>  <b>2,131 P</b>	<b>2,483 W</b>  <b>2,302 P</b>
	<b>C2366R-FP</b> - _ - _ - _  <b>C2166R-FP</b> - _ - _ - _	single pedestal credenza right box/box/file pedestal	20	66	29	class 125 cwt 215 lb cu ft 26	<b>2,275 W</b>  <b>1,971 P</b>	<b>2,458 W</b>  <b>2,130 P</b>
	<b>C236624R-FP</b> - _ - _ - _  <b>C216624R-FP</b> - _ - _ - _	single pedestal credenza right box/box/file pedestal	24	66	29	class 125 cwt 215 lb cu ft 26	<b>2,386 W</b>  <b>2,259 P</b>	<b>2,577 W</b>  <b>2,440 P</b>
	<b>C2366L-FP</b> - _ - _ - _  <b>C2166L-FP</b> - _ - _ - _	single pedestal credenza left box/box/file pedestal	20	66	29	class 125 cwt 215 lb cu ft 26	<b>2,275 W</b>  <b>1,971 P</b>	<b>2,458 W</b>  <b>2,130 P</b>
	<b>C236624L-FP</b> - _ - _ - _  <b>C216624L-FP</b> - _ - _ - _	single pedestal credenza left box/box/file pedestal	24	66	29	class 125 cwt 215 lb cu ft 26	<b>2,386 W</b>  <b>2,259 P</b>	<b>2,577 W</b>  <b>2,440 P</b>
	<b>C2366R-3Q2F</b> - _ - _ - _  <b>C2166R-3Q2F</b> - _ - _ - _	single pedestal credenza right lateral file pedestal	20	66	29	class 125 cwt 280 lb cu ft 26	<b>1,974 W</b>  <b>1,762 P</b>	<b>2,142 W</b>  <b>1,903 P</b>
	<b>C236624R-3Q2F</b> - _ - _ - _ - _ <b>C216624R-3Q2F</b> - _ - _ - _ - _	single pedestal credenza right lateral file pedestal	24	66	29	class 125 cwt 280 lb cu ft 26	<b>2,238 W</b>  <b>2,067 P</b>	<b>2,417 W</b>  <b>2,232 P</b>
	<b>C2366L-3Q2F</b> - _ - _ - _  <b>C2166L-3Q2F</b> - _ - _ - _	single pedestal credenza left lateral file pedestal	20	66	29	class 125 cwt 280 lb cu ft 26	<b>1,974 W</b>  <b>1,762 P</b>	<b>2,142 W</b>  <b>1,903 P</b>

top

laminat  
topvener top

\$138 list upcharge for putting any additional pulls on a  
2300/2100 unit → allegro → forte → presto

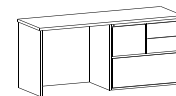

We offer a 4D  
configuration option  
(as shown). For  
information please call  
customer service.



ovation/bravo | 2300 series  
2100 series

| wood top, veneer chassis, veneer drawer fronts  
| laminate top, veneer chassis, veneer drawer fronts



ovation/bravo  
2300/2100

	model number	description		freight	list \$ zone 1	zone 2
	C236624L-3Q2F - _ - _	single pedestal credenza left lateral file pedestal	24 66 29	class 125 cwt 280 lb cu ft 26	<b>2,238 W</b>	<b>2,417 W</b>
	C216624L-3Q2F - _ - _				<b>2,067 P</b>	<b>2,232 P</b>
	C2366R-FM2F - _ - _ - _	single pedestal credenza right lateral file pedestal	20 66 29	class 125 cwt 285 lb cu ft 26	<b>2,150 W</b>	<b>2,323 W</b>
	C2166R-FM2F - _ - _ - _				<b>1,930 P</b>	<b>2,084 P</b>
	C236624R-FM2F - _ - _	single pedestal credenza right lateral file pedestal	24 66 29	class 125 cwt 285 lb cu ft 26	<b>2,425 W</b>	<b>2,619 W</b>
	C216624R-FM2F - _ - _				<b>2,257 P</b>	<b>2,438 P</b>
	C2366L-FM2F - _ - _ - _	single pedestal credenza left lateral file pedestal	20 66 29	class 125 cwt 285 lb cu ft 26	<b>2,150 W</b>	<b>2,323 W</b>
	C2166L-FM2F - _ - _ - _				<b>1,930 P</b>	<b>2,084 P</b>
	C236624L-FM2F - _ - _	single pedestal credenza left lateral file pedestal	24 66 29	class 125 cwt 285 lb cu ft 26	<b>2,425 W</b>	<b>2,619 W</b>
	C216624L-FM2F - _ - _				<b>2,257 P</b>	<b>2,438 P</b>
	C2366R-3Q5D - _ - _ - _	single pedestal credenza right multi-file pedestal	20 66 29	class 125 cwt 280 lb cu ft 26	<b>2,836 W</b>	<b>3,061 W</b>
	C2166R-3Q5D - _ - _ - _				<b>2,645 P</b>	<b>2,856 P</b>
	C236624R-3Q5D - _ - _	single pedestal credenza right multi-file pedestal	24 66 29	class 125 cwt 280 lb cu ft 26	<b>3,100 W</b>	<b>3,348 W</b>
	C216624R-3Q5D - _ - _				<b>2,949 P</b>	<b>3,184 P</b>
	C2366L-3Q5D - _ - _ - _	single pedestal credenza left multi-file pedestal	20 66 29	class 125 cwt 280 lb cu ft 26	<b>2,836 W</b>	<b>3,061 W</b>
	C2166L-3Q5D - _ - _ - _				<b>2,645 P</b>	<b>2,856 P</b>
	C236624L-3Q5D - _ - _	single pedestal credenza left multi-file pedestal	24 66 29	class 125 cwt 280 lb cu ft 26	<b>3,100 W</b>	<b>3,348 W</b>
	C216624L-3Q5D - _ - _				<b>2,949 P</b>	<b>3,184 P</b>

**chassis models**

<b>3Q</b> 3/4 pedestal 3/4 modesty	<b>laminated</b> tops only	<b>3L-P</b> saddle on walnut <b>4L-P</b> dark mahogany on walnut <b>25M-P</b> mahogany on walnut <b>25B-P</b> ebony on walnut <b>25C-P</b> cherry on walnut <b>2ML-P</b> natural maple <b>3ML-P</b> light maple <b>4ML-P</b> medium maple <b>5ML-P</b> cherry on maple <b>6LC-P</b> light cherry on cherry <b>7MC-P</b> medium cherry on cherry <b>8DC-P</b> dark cherry on cherry	<b>veneer</b> top and chassis finish	<b>3L-W</b> saddle on walnut <b>2KL-W</b> sepia on walnut <b>4L-W</b> dark mahogany on walnut <b>25M-W</b> mahogany on walnut <b>25B-W</b> ebony on walnut <b>25C-W</b> cherry on walnut <b>2ML-W</b> natural maple <b>3ML-W</b> light maple <b>4ML-W</b> medium maple <b>5ML-W</b> cherry on maple <b>6LC-W</b> light cherry on cherry <b>1NC-W</b> natural cherry on cherry <b>2HC-W</b> honey cherry on cherry	<b>7MC-W</b> medium cherry on cherry <b>8DC-W</b> dark cherry on cherry <b>9BC-W</b> burgundy cherry on cherry
---------------------------------------	-------------------------------	---	---	---	--

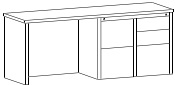
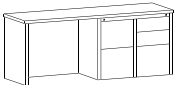
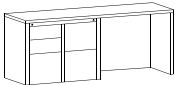
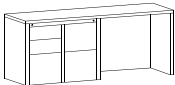
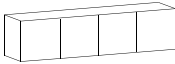
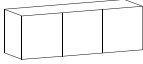
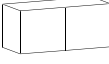
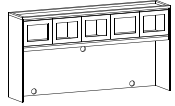
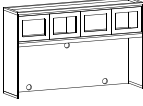

	model number	description	d	w	h	freight	list \$ zone 1	list \$ zone 2
	<b>C2366R-FM5D</b> - _ - _ -	single pedestal credenza right multi-file pedestal	20	66	29	class 125 cwt 285 lb cu ft 26	<b>3,003 W</b>	<b>3,243 W</b>
	<b>C2166R-FM5D</b> - _ - _ -						<b>2,812 P</b>	<b>3,038 P</b>
	<b>C236624R-FM5D</b> - _ - - - -	single pedestal credenza right multi-file pedestal	24	66	29	class 125 cwt 285 lb cu ft 26	<b>3,278 W</b>	<b>3,539 W</b>
	<b>C216624R-FM5D</b> - _ - - - -						<b>3,140 P</b>	<b>3,392 P</b>
	<b>C2366L-FM5D</b> - _ - _ -	single pedestal credenza left multi-file pedestal	20	66	29	class 125 cwt 285 lb cu ft 26	<b>3,003 W</b>	<b>3,243 W</b>
	<b>C2166L-FM5D</b> - _ - _ -						<b>2,812 P</b>	<b>3,038 P</b>
	<b>C236624L-FM5D</b> - _ - - - -	single pedestal credenza left multi-file pedestal	24	66	29	class 125 cwt 285 lb cu ft 26	<b>3,278 W</b>	<b>3,539 W</b>
	<b>C216624L-FM5D</b> - _ - - - -						<b>3,140 P</b>	<b>3,392 P</b>
	<b>WH66</b> - _	66" wide wall hung unit overhead four hinged doors  <i>OPTIONAL FRAMED FROSTED GLASS DOORS \$520</i> <i>OPTIONAL FRAMED GLASS DOORS \$414</i> <i>OPTIONAL FRAMED CHEMCAST DOORS \$360</i>	16	66	16	class 125 cwt 110 lb cu ft 13	<b>1,792</b>	<b>1,935</b>
	<b>WH48</b> - _	48" wide wall hung unit overhead three hinged doors  <i>OPTIONAL FRAMED FROSTED GLASS DOOR \$443</i> <i>OPTIONAL FRAMED GLASS DOORS \$275</i> <i>OPTIONAL FRAMED CHEMCAST DOORS \$240</i>	16	48	16	class 125 cwt 90 lb cu ft 10	<b>1,541</b>	<b>1,665</b>
	<b>WH36</b> - _	36" wide wall hung unit overhead two hinged doors  <i>OPTIONAL FRAMED FROSTED GLASS DOOR \$295</i> <i>OPTIONAL FRAMED GLASS DOORS \$182</i> <i>OPTIONAL FRAMED CHEMCAST DOORS \$115</i>	16	36	16	class 125 cwt 75 lb cu ft 7	<b>1,010</b>	<b>1,090</b>
	<b>OUGL2384</b> - _ - -	84" wide overhead storage unit with framed glass doors "FG" frosted glass "GL" standard glass three wire management grommets  <i>TOUCH LATCH UNLESS OPTIONAL PULLS ORDERED</i>	16.5	82.5	43.25	class 125 cwt 210 lb cu ft 40	opening: 25.9"	<b>4,065</b>
	<b>OUGL2184</b> - _ - -							<b>4,391</b>
	<b>OUFG2384</b> - _ - -							<b>4,165</b>
	<b>OUFG2184</b> - _ - -							<b>4,498</b>
	<b>OUGL2372</b> - _ - -	72" wide overhead storage unit with framed glass doors "FG" frosted glass "GL" standard glass three wire management grommets  <i>TOUCH LATCH UNLESS OPTIONAL PULLS ORDERED</i>	16.5	70.25	43.25	class 125 cwt 210 lb cu ft 40	opening: 25.9"	<b>3,183</b>
	<b>OUGL2172</b> - _ - -							<b>3,387</b>
	<b>OUFG2372</b> - _ - -							<b>3,263</b>
	<b>OUFG2172</b> - _ - -							<b>3,466</b>

**top**

laminated  
top veneer top

for **tackboard options**, see pages 522-523  
for standard fabrics available on tackboards, see page 504

\$138 list upcharge for putting any additional pulls on a  
2300/2100 unit → allegro → forte → presto

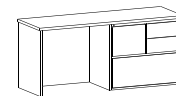

We offer a 4D  
configuration option  
(as shown). For  
information please call  
customer service.





ovation/bravo | 2300 series  
2100 series

| wood top, veneer chassis, veneer drawer fronts  
| laminate top, veneer chassis, veneer drawer fronts

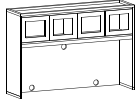
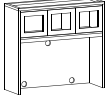

ovation/bravo  
2300/2100

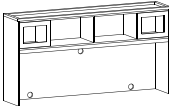
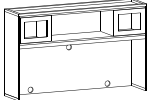
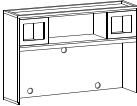
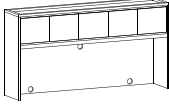
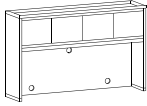
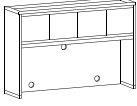
	model number	description	freight	list \$ zone 1	zone 2
	<b>OUGL2366</b> - - - <b>OUGL2166</b> - - -  <b>OUEG2366</b> - - - <b>OUEG2166</b> - - -	66" wide overhead storage unit with framed glass doors "FG" frosted glass "GL" standard glass three wire management grommets  <i>TOUCH LATCH UNLESS OPTIONAL PULLS ORDERED</i>	16.5 64.25 43.25  opening: 25.9"	class 125 cwt 190 lb cu ft 38  3,094  3,173	3,293  3,371
	<b>OUGL2348</b> - - - <b>OUGL2148</b> - - -  <b>OUEG2348</b> - - - <b>OUEG2148</b> - - -	48" wide overhead storage unit with framed glass doors "FG" frosted glass "GL" standard glass three wire management grommets  <i>TOUCH LATCH UNLESS OPTIONAL PULLS ORDERED</i>	16.5 48 43.25  opening: 25.9"	class 125 cwt 190 lb cu ft 38  2,461  2,520	2,658  2,722
	<b>OUGL2336</b> - - - <b>OUGL2136</b> - - -  <b>OUEG2336</b> - - - <b>OUEG2136</b> - - -	36" wide overhead storage unit with framed glass doors "FG" frosted glass "GL" standard glass two wire management grommets  <i>TOUCH LATCH UNLESS OPTIONAL PULLS ORDERED</i>	16.5 36 43.25  opening: 25.9"	class 125 cwt 190 lb cu ft 38  2,073  2,113	2,238  2,282
	<b>ODGL2384</b> - - - <b>ODGL2184</b> - - -  <b>ODFG2384</b> - - - <b>ODFG2184</b> - - -	84" wide overhead storage unit with framed glass doors "FG" frosted glass "GL" standard glass three wire management grommets  <i>TOUCH LATCH UNLESS OPTIONAL PULLS ORDERED</i>	16.5 84 43.25  opening: 25.9"	class 125 cwt 200 lb cu ft 40  3,414  3,454	3,686  3,730
	<b>ODGL2372</b> - - - <b>ODGL2172</b> - - -  <b>ODFG2372</b> - - - <b>ODFG2172</b> - - -	72" wide overhead storage unit with framed glass doors "FG" frosted glass "GL" standard glass three wire management grommets  <i>TOUCH LATCH UNLESS OPTIONAL PULLS ORDERED</i>	16.5 70.25 43.25  opening: 25.9"	class 125 cwt 200 lb cu ft 40  2,662  2,702	2,792  2,832
	<b>ODGL2366</b> - - - <b>ODGL2166</b> - - -  <b>ODFG2366</b> - - - <b>ODFG2166</b> - - -	66" wide overhead storage unit with framed glass doors "FG" frosted glass "GL" standard glass three wire management grommets  <i>TOUCH LATCH UNLESS OPTIONAL PULLS ORDERED</i>	16.5 64.25 43.25  opening: 25.9"	class 125 cwt 175 lb cu ft 38  2,491  2,530	2,671  2,710
	<b>OU2384</b> - - -  <b>OU2184</b> - - -	84" wide overhead storage unit five hinged doors three wire management grommets  <i>TOUCH LATCH UNLESS OPTIONAL PULLS ORDERED</i>	16.5 82.5 43.25  opening: 25.9"	class 125 cwt 210 lb cu ft 40  3,413 W  3,413 P	3,685 W  3,685 P
[ QS ] 	<b>OU2372</b> - - - Quick Ship available in 25M mahogany with C edge  <b>OU2172</b> - - - Quick Ship available in 8DC dark cherry with B edge	72" wide overhead storage unit four hinged doors three wire management grommets  <i>TOUCH LATCH UNLESS OPTIONAL PULLS ORDERED</i>	16.5 70.25 43.25  opening: 25.9"	class 125 cwt 210 lb cu ft 40  2,661 W  2,661 P	2,864 W  2,864 P
	<b>OU2366</b> - - -  <b>OU2166</b> - - -	66" wide overhead storage unit four hinged doors three wire management grommets  <i>TOUCH LATCH UNLESS OPTIONAL PULLS ORDERED</i>	16.5 64.25 43.25  opening: 25.9"	class 125 cwt 190 lb cu ft 38  2,571 W  2,571 P	2,770 W  2,770 P

**chassis models**

**3Q** 3/4 pedestal  
3/4 modesty  
  
**FM** 3/4 pedestal  
full modesty  
**FP** full pedestal  
full modesty

**laminate**  
tops only



**3L-P** saddle on walnut  
**4L-P** dark mahogany on walnut  
**25M-P** mahogany on walnut  
**25B-P** ebony on walnut  
**25C-P** cherry on walnut  
**2ML-P** natural maple  
**3ML-P** light maple  
**4ML-P** medium maple  
**5ML-P** cherry on maple  
**6LC-P** light cherry on cherry  
**7MC-P** medium cherry on cherry  
**8DC-P** dark cherry on cherry

**veneer**  
top and  
chassis  
finish

**3L-W** saddle on walnut  
**2KL-W** sepia on walnut  
**4L-W** dark mahogany on walnut  
**25M-W** mahogany on walnut  
**25B-W** ebony on walnut  
**25C-W** cherry on walnut  
**2ML-W** natural maple  
**3ML-W** light maple  
**4ML-W** medium maple  
**5ML-W** cherry on maple  
**6LC-W** light cherry on cherry  
**1NC-W** natural cherry on cherry  
**2HC-W** honey cherry on cherry

**7MC-W** medium cherry on cherry  
**8DC-W** dark cherry on cherry  
**9BC-W** burgundy cherry on cherry

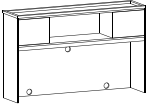
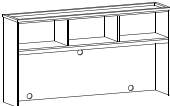
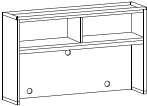
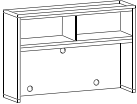
chemcast overhead doors in place  
of wood doors  
- 2 doors, \$219 list upcharge  
- 3-4 doors, \$346 list upcharge  
- 5 doors, \$436 list upcharge

	model number	description	d w h	freight	list \$ zone 1	list \$ zone 2
	<b>OU2348</b> - _ - _  <b>OU2148</b> - _ - _	48" wide overhead with three doors three wire management grommets  <i>TOUCH LATCH UNLESS OPTIONAL PULLS ORDERED</i>	16.5 48 43.25  opening: 25.9"	class 125 cwt 150 lb cu ft 26	<b>2,070 W</b>  <b>2,070 P</b>	<b>2,240 W</b>  <b>2,240 P</b>
	<b>OU2336</b> - _ - _  <b>OU2136</b> - _ - _	36" wide overhead with two doors two wire management grommets  <i>TOUCH LATCH UNLESS OPTIONAL PULLS ORDERED</i>	16.5 35 43.25  opening: 25.9"	class 125 cwt 115 lb cu ft 19	<b>1,812 W</b>  <b>1,812 P</b>	<b>1,965 W</b>  <b>1,965 P</b>
	<b>OD2384</b> - _ - _  <b>OD2184</b> - _ - _	84" wide overhead storage unit with open center one hinged door on each end three wire management grommets  <i>TOUCH LATCH UNLESS OPTIONAL PULLS ORDERED</i>	16.5 82.5 43.25  opening: 25.9"	class 125 cwt 200 lb cu ft 40	<b>3,153 W</b>  <b>3,153 P</b>	<b>3,405 W</b>  <b>3,405 P</b>
	<b>OD2372</b> - _ - _  <b>OD2172</b> - _ - _	72" wide overhead storage unit with open center one hinged door on each end three wire management grommets  <i>TOUCH LATCH UNLESS OPTIONAL PULLS ORDERED</i>	16.5 70.25 43.25  opening: 25.9"	class 125 cwt 200 lb cu ft 40	<b>2,402 W</b>  <b>2,402 P</b>	<b>2,531 W</b>  <b>2,531 P</b>
	<b>OD2366</b> - _ - _  <b>OD2166</b> - _ - _	66" wide storage unit with open center one hinged door on each end three wire management grommets  <i>TOUCH LATCH UNLESS OPTIONAL PULLS ORDERED</i>	16.5 64.25 43.25  opening: 25.9"	class 125 cwt 175 lb cu ft 38	<b>2,230 W</b>  <b>2,230 P</b>	<b>2,410 W</b>  <b>2,410 P</b>
	<b>OO2384</b> - _ - _  <b>OO2184</b> - _ - _	84" wide open overhead storage unit with open center three wire management grommets	16.5 82.5 43.25  opening: 25.9"	class 125 cwt 195 lb cu ft 40	<b>2,734 W</b>  <b>2,734 P</b>	<b>2,952 W</b>  <b>2,952 P</b>
	<b>OO2372</b> - _ - _  <b>OO2172</b> - _ - _	72" wide open overhead storage unit with open center three wire management grommets	16.5 70.25 43.25  opening: 25.9"	class 125 cwt 195 lb cu ft 40	<b>1,983 W</b>  <b>1,983 P</b>	<b>2,142 W</b>  <b>2,142 P</b>
	<b>OO2366</b> - _ - _  <b>OO2166</b> - _ - _	66" wide open overhead storage unit with open center three wire management grommets	16.5 64.25 43.25  opening: 25.9"	class 125 cwt 170 lb cu ft 38	<b>1,910 W</b>  <b>1,910 P</b>	<b>2,064 W</b>  <b>2,064 P</b>
	<b>OO2348</b> - _ - _  <b>OO2148</b> - _ - _	48" wide open overhead storage unit with open center three wire management grommets	16.5 48 43.25  opening: 25.9"	class 125 cwt 115 lb cu ft 19	<b>1,561 W</b>  <b>1,561 P</b>	<b>1,686 W</b>  <b>1,686 P</b>

top

laminat  
topvene  
er top

\$138 list upcharge for putting any additional pulls on a  
2300/2100 unit → allegro → forte → presto

chemcast overhead doors in place  
of wood doors  
→ 2 doors, \$219 list upcharge  
→ 3-4 doors, \$346 list upcharge  
→ 5 doors, \$436 list upcharge









ovation/bravo | 2300 series  
2100 series

| wood top, veneer chassis, veneer drawer fronts  
| laminate top, veneer chassis, veneer drawer fronts

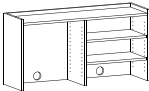
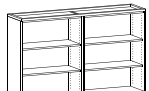
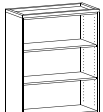

ovation/bravo  
2300/2100

	model number	description		freight	list \$	zone 1	zone 2
	<b>OO2336</b> - _ - _  <b>OO2136</b> - _ - _	36" wide open overhead storage unit with open center three wire management grommets	16.5 36 43.25	class 125 cwt 105 lb cu ft 26	<b>1,435</b>		<b>1,549</b>
	<b>USU84</b> - _	underside paper storage for use with 84" overhead storage units does not prevent the use of task lights or tackboards  <i>FACTORY INSTALLED</i>	15.5 82 4	class cwt lb cu ft	<b>512</b>		<b>554</b>
	<b>USU72</b> - _	underside paper storage for use with 72" overhead storage units does not prevent the use of task lights or tackboards  <i>FACTORY INSTALLED</i>	15.5 70 4	class cwt lb cu ft	<b>498</b>		<b>536</b>
	<b>USU66</b> - _	underside paper storage for use with 66" overhead storage units does not prevent the use of task lights or tackboards  <i>FACTORY INSTALLED</i>	15.5 64 4	class cwt lb cu ft	<b>498</b>		<b>536</b>
	<b>USU48</b> - _	underside paper storage for use with 48" overhead storage units does not prevent the use of task lights or tackboards  <i>FACTORY INSTALLED</i>	15.5 46 4	class cwt lb cu ft	<b>292</b>		<b>315</b>
	<b>USU36</b> - _	underside paper storage for use with 36" overhead storage units does not prevent the use of task lights or tackboards  <i>FACTORY INSTALLED</i>	15.5 34 4	class cwt lb cu ft	<b>292 W</b>  <b>P</b>		<b>315 W</b>  <b>P</b>
	<b>H2348</b> - _  <b>H2148</b> - _	hutch with wire management grommets with two adjustable shelves  <i>CAN BE USED WITH A 48" DESK OR COMPUTER PRINTER STAND</i> <i>ADDITIONAL SHELVES (EACH) \$92</i> <i>SOLID WOOD SHELVES (EACH) \$434</i>	14 47 24	class 125 cwt 90 lb cu ft 12	<b>1,084</b>		<b>1,168</b>
	<b>HO2371</b> - _ - _  <b>HO2171</b> - _ - _	hutch two adjustable shelves on each side  <i>TO SET ON 4HW2374, 4FD2374, 4HW2174, 4FD2174, CR2372D, OR CR2172P</i> <i>ADDITIONAL SHELVES (EACH) \$92</i> <i>SOLID WOOD SHELVES (EACH) \$434</i>	16.5 70 43.25	class 125 cwt 235 lb cu ft 42	<b>3,129</b>		<b>3,561</b>
	<b>HO2336</b> - _ - _  <b>HO2136</b> - _ - _	hutch two adjustable shelves on each side  <i>TO SET ON HW2337, 2FD2337, HW2137 OR 2FD2137</i> <i>ADDITIONAL SHELVES (EACH) \$92</i> <i>SOLID WOOD SHELVES (EACH) \$434</i>	16.5 35 43.25	class 125 cwt 100 lb cu ft 21	<b>1,549</b>		<b>1,763</b>

**chassis models**

<b>3Q</b> 3/4 pedestal 3/4 modesty	<b>laminate</b> tops only	<b>3L-P</b> saddle on walnut <b>4L-P</b> dark mahogany on walnut <b>25M-P</b> mahogany on walnut <b>25B-P</b> ebony on walnut <b>25C-P</b> cherry on walnut <b>2ML-P</b> natural maple <b>3ML-P</b> light maple <b>4ML-P</b> medium maple <b>5ML-P</b> cherry on maple <b>6LC-P</b> light cherry on cherry <b>7MC-P</b> medium cherry on cherry <b>8DC-P</b> dark cherry on cherry	<b>veneer</b> top and chassis finish	<b>3L-W</b> saddle on walnut <b>2KL-W</b> sepia on walnut <b>4L-W</b> dark mahogany on walnut <b>25M-W</b> mahogany on walnut <b>25B-W</b> ebony on walnut <b>25C-W</b> cherry on walnut <b>2ML-W</b> natural maple <b>3ML-W</b> light maple <b>4ML-W</b> medium maple <b>5ML-W</b> cherry on maple <b>6LC-W</b> light cherry on cherry <b>1NC-W</b> natural cherry on cherry <b>2HC-W</b> honey cherry on cherry	<b>7MC-W</b> medium cherry on cherry <b>8DC-W</b> dark cherry on cherry <b>9BC-W</b> burgundy cherry on cherry
---------------------------------------	------------------------------	---	---	---	--

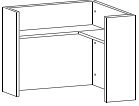
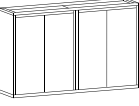
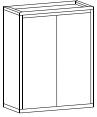
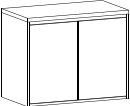
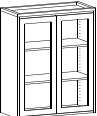
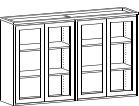
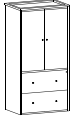
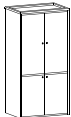
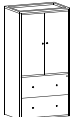
	model number	description	d	w	h	freight	list \$ zone 1	list \$ zone 2
	CUH - _ _	corner unit hutch  <i>FOR USE WITH CU2338 OR CU2138</i>	38	12	32	class 85 kd cwt 105 lb cu ft 20	1,812	1,994
	HW2371 - _ _ _ HW2171 - _ _ _	hinged door cabinet wood doors two adjustable shelves in each side  <i>TO SET ON 4HW2374, 4FD2374, 4HW2174, 4FD2174, CR2372D OR CR2172D</i> ADDITIONAL SHELVES (EACH) \$92 SOLID WOOD SHELVES (EACH) \$434	16.5	70	43.25	class 125 cwt 250 lb cu ft 42	4,549	4,925
	HW2336 - _ _ _ HW2136 - _ _ _	hinged door cabinet wood doors two adjustable shelves  <i>TO SET ON HW2337, 2FD2337, HW2137 OR 2FD2137</i> ADDITIONAL SHELVES (EACH) \$92 SOLID WOOD SHELVES (EACH) \$434	16.5	35	43.25	class 125 cwt 125 lb cu ft 21	2,275	2,463
	HW2337 - _ _ _ _ HW2137 - _ _ _ _	hinged door cabinet wood doors one adjustable shelf  ADDITIONAL SHELVES (EACH) \$92 SOLID WOOD SHELVES (EACH) \$434	20	36	29	class 125 cwt 175 lb cu ft 16	1,958	2,111
	HD2336 - _ _ _ HD2136 - _ _ _	hinged door cabinet glass doors, two adjustable wood shelves in each side  <i>TO SET ON HW2337, 2FD2337, HW2137 OR 2FD2137</i> ADDITIONAL SHELVES (EACH) \$92 SOLID WOOD SHELVES (EACH) \$434	16.5	35	43.25	class 125 cwt 250 lb cu ft 42	2,572	2,761
	HD2371 - _ _ _ HD2171 - _ _ _	hinged door cabinet glass doors 4 adjustable wood shelves  <i>TO SET ON 4HW2374, 4FD2374, 4HW2174, 4FD2174, CR2372D OR CR2172D</i> ADDITIONAL SHELVES (EACH) \$92 SOLID WOOD SHELVES (EACH) \$434	16.5	70	43.25	class 125 cwt 125 lb cu ft 21	5,146	5,521
	AV23722F - _ _ _ AV21722F - _ _ _	tv cabinet pocket doors with pull-out swivel tv tray upper lateral file below	24	36	72	class 125 cwt 340 lb cu ft 43	5,957	6,433
	AV2372HW - _ _ _ AV2172HW - _ _ _	tv cabinet pocket doors with pull-out swivel tv tray upper hinged doors below with one adjustable shelf  ADDITIONAL SHELVES (EACH) \$92 SOLID WOOD SHELVES (EACH) \$434	24	36	72	class 125 cwt 290 lb cu ft 43	5,754	6,217
	HW23722F - _ _ _ HW21722F - _ _ _	storage cabinet hinged doors with two adjustable shelves upper lateral file below  ADDITIONAL SHELVES (EACH) \$92 SOLID WOOD SHELVES (EACH) \$434	24	36	72	class 125 cwt 320 lb cu ft 43	5,199	5,615

top

laminat  
topveneer top

\$138 list upcharge for putting any additional pulls on a  
2300/2100 unit → allegro → forte → presto





ovation/bravo | 2300 series  
2100 series

| wood top, veneer chassis, veneer drawer fronts  
| laminate top, veneer chassis, veneer drawer fronts

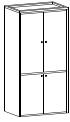
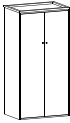

ovation/bravo  
2300/2100

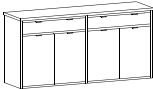
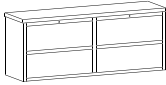
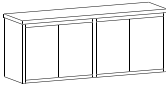
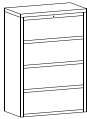
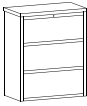
	model number	description		freight	list \$ zone 1	zone 2
	<b>HW2372HW</b> - _ - _	storage cabinet hinged doors with two adjustable shelves upper and one adjustable shelf in lower cabinet	24 36 72	class 125 cwt 270 lb cu ft 43	<b>4,980</b>	<b>5,384</b>
	<b>HW2172HW</b> - _ - _	<i>ADDITIONAL SHELVES (EACH) \$92</i> <i>SOLID WOOD SHELVES (EACH) \$434</i>			<b>4,980</b>	<b>5,384</b>
	<b>WD2372</b> - _ - _	wardrobe two hinged doors, right side coat storage	24 36 72	class 125 cwt 320 lb cu ft 42	<b>3,728</b>	<b>4,027</b>
	<b>WD2172</b> - _ - _	left side three adjustable shelves storage shelf above one fixed shelf <i>INSIDE DIMENSIONS: 21 x 33 x 69</i>			<b>3,728</b>	<b>4,027</b>
	<b>WD2372R-18</b> - _	wardrobe one hinged door hinge on right/knob on left coat storage	24 18 72	class 125 cwt 170 lb cu ft 23	<b>2,682</b>	<b>2,938</b>
	<b>WD2172R-18</b> - _	<i>INSIDE DIMENSIONS: 21 x 16.5 x 69</i> <i>SOLID WOOD SHELVES (EACH) \$434</i>			<b>2,682</b>	<b>2,938</b>
	<b>WD2372L-18</b> - _	wardrobe one hinged door hinge on left/knob on right coat storage	24 18 72	class 125 cwt 170 lb cu ft 23	<b>2,682</b>	<b>2,938</b>
	<b>WD2172L-18</b> - _	<i>INSIDE DIMENSIONS: 21 x 16.5 x 69</i> <i>SOLID WOOD SHELVES (EACH) \$434</i>			<b>2,682</b>	<b>2,938</b>
	<b>4HW2374D-36</b> - _ - _ - _	serving height credenza two sets of hinged doors with one adjustable shelf on each side two drawers above	20 72 36	class 125 cwt 405 lb cu ft 37	<b>4,561 W</b>	<b>4,927 W</b>
	<b>4HW2174D-36</b> - _ - _ - _	<i>ADDITIONAL SHELVES (EACH) \$92</i> <i>SOLID WOOD SHELVES (EACH) \$434</i>			<b>3,992 P</b>	<b>4,307 P</b>
	<b>4FD2374</b> - _ - _ - _	lateral file/four drawers two drawers side by side under common top standard anti-tip locking mechanism	20 72 29	class 125 cwt 340 lb cu ft 30	<b>4,338 W</b>	<b>4,671 W</b>
	<b>4FD2174</b> - _ - _ - _	<i>ADDITIONAL SHELVES (EACH) \$92</i> <i>SOLID WOOD SHELVES (EACH) \$434</i>			<b>3,685 P</b>	<b>3,964 P</b>
	<b>4HW2374</b> - _ - _ - _	2-hinged door cabinets under common top with one adjustable shelf each	20 72 29	class 125 cwt 260 lb cu ft 32	<b>3,920 W</b>	<b>4,222 W</b>
	<b>4HW2174</b> - _ - _ - _	<i>INSIDE DIMENSIONS: 18 x 34.5 x 27</i> <i>ADDITIONAL SHELVES (EACH) \$92</i> <i>SOLID WOOD SHELVES (EACH) \$434</i>			<b>3,330 P</b>	<b>3,582 P</b>
	<b>4FD2337</b> - _ - _ - _	lateral file with four drawers standard anti-tip locking system	20 36 54.75	class 125 cwt 265 lb cu ft 29	<b>3,204 W</b>	<b>3,458 W</b>
	<b>4FD2137</b> - _ - _ - _				<b>2,856 P</b>	<b>3,209 P</b>
	<b>3FD2337</b> - _ - _ - _	lateral file with three drawers standard anti-tip locking system	20 36 41	class 125 cwt 255 lb cu ft 25	<b>2,995 W</b>	<b>3,225 W</b>
	<b>3FD2137</b> - _ - _ - _				<b>2,543 P</b>	<b>2,734 P</b>

**chassis models**

<b>3Q</b> 3/4 pedestal 3/4 modesty	<b>laminated</b> tops only	<b>3L-P</b> saddle on walnut <b>4L-P</b> dark mahogany on walnut <b>25M-P</b> mahogany on walnut <b>25B-P</b> ebony on walnut <b>25C-P</b> cherry on walnut <b>2ML-P</b> natural maple <b>3ML-P</b> light maple <b>4ML-P</b> medium maple <b>5ML-P</b> cherry on maple <b>6LC-P</b> light cherry on cherry <b>7MC-P</b> medium cherry on cherry <b>8DC-P</b> dark cherry on cherry	<b>veneer</b> top and chassis finish	<b>3L-W</b> saddle on walnut <b>2KL-W</b> sepia on walnut <b>4L-W</b> dark mahogany on walnut <b>25M-W</b> mahogany on walnut <b>25B-W</b> ebony on walnut <b>25C-W</b> cherry on walnut <b>2ML-W</b> natural maple <b>3ML-W</b> light maple <b>4ML-W</b> medium maple <b>5ML-W</b> cherry on maple <b>6LC-W</b> light cherry on cherry <b>1NC-W</b> natural cherry on cherry <b>2HC-W</b> honey cherry on cherry	<b>7MC-W</b> medium cherry on cherry <b>8DC-W</b> dark cherry on cherry <b>9BC-W</b> burgundy cherry on cherry
---------------------------------------	-------------------------------	---	---	---	--

[ QS ]	model number	description	d	w	h	freight	list \$ zone 1	list \$ zone 2
[ QS ]	<b>2FD2337</b> - _ - _ - _ Quick Ship available in 25M mahogany with C edge	lateral file with two drawers standard anti-tip locking system	20	36	29	class 125 cwt 175 lb cu ft 16	<b>2,169</b>	<b>2,337</b>
[ QS ]	<b>2FD2137</b> - _ - _ - _ Quick Ship available in 8DC dark cherry with B edge						<b>1,793</b>	<b>1,962</b>
	<b>MP232F</b> - _ - <b>MP212F</b> - _ -	mobile peestal file/file drawers with locking casters for use under an 29" surface black tray top  <i>NO OPTIONAL EDGE</i>	18.9	16.6	27.3	class 125 cwt 75 lb cu ft 6	<b>1,217</b>	<b>1,315</b>
	<b>MP233D</b> - _ - <b>MP213D</b> - _ -	mobile pedestal box/box/file drawers with locking casters for use under any 29" surface black tray top  <i>NO OPTIONAL EDGE</i>	18.9	16.6	27.3	class 125 cwt 75 lb cu ft 6	<b>1,232</b>	<b>1,331</b>
	<b>HW2FD2337</b> - _ - _ - _ <b>HW2FD2137</b> - _ - _ - _	hutch and lateral file wood doors and two adjustable shelves, two drawer lateral file with standard anti-tip locking mechanism  <i>ADDITIONAL SHELVES (EACH) \$92</i> <i>SOLID WOOD SHELVES (EACH) \$434</i>	20	36	72.5	class 125 cwt 300 lb cu ft 27	<b>4,443 W</b>  <b>4,065 P</b>	<b>4,799 W</b>  <b>4,424 P</b>
	<b>HWHW2337</b> - _ - _ - _ <b>HWHW2137</b> - _ - _ - _	hutch and hinged door cabinet wood doors and two adjustable shelves, hinged wood door cabinet has one adjustable shelf  <i>ADDITIONAL SHELVES (EACH) \$92</i> <i>SOLID WOOD SHELVES (EACH) \$434</i>	20	36	72.5	class 125 cwt 300 lb cu ft 37	<b>4,235 W</b>  <b>3,939 P</b>	<b>4,574 W</b>  <b>4,254 P</b>
	<b>HO2FD2337</b> - _ - _ - _ <b>HO2FD2137</b> - _ - _ - _	open hutch and lateral file two adjustable shelves, two drawer lateral file with standard anti-tip locking mechanism  <i>ADDITIONAL SHELVES (EACH) \$92</i> <i>SOLID WOOD SHELVES (EACH) \$434</i>	20	36	72.5	class 125 cwt 280 lb cu ft 37	<b>3,716 W</b>  <b>3,341 P</b>	<b>4,098 W</b>  <b>3,724 P</b>
	<b>HOHW2337</b> - _ - _ - _ <b>HOHW2137</b> - _ - _ - _	open hutch and hinged door cabinet two adjustable shelves, hinged wood door cabinet has one adjustable shelf  <i>ADDITIONAL SHELVES (EACH) \$92</i> <i>SOLID WOOD SHELVES (EACH) \$434</i>	20	36	72.5	class 125 cwt 280 lb cu ft 37	<b>3,508 W</b>  <b>3,213 P</b>	<b>3,875 W</b>  <b>3,555 P</b>
	<b>P2330</b> - _ - _ - _ <b>P2130</b> - _ - _ - _	printer stand with paper slot one adjustable shelf  <i>ADDITIONAL SHELVES (EACH) \$92</i>	20	30	29	class 125 cwt 95 lb cu ft 18	<b>1,089 W</b>  <b>925 P</b>	<b>1,177 W</b>  <b>996 P</b>
	<b>CRP23483Q-29</b> - _ - _ - _ - <b>CRP21483Q-29</b> - _ - _ - _ -	computer printer stand one fixed shelf  <i>KNEESPACE: 45"</i>	24	48	29	class 150 cwt 125 lb cu ft 22	<b>1,880 W</b>  <b>1,596 P</b>	<b>2,022 W</b>  <b>1,717 P</b>

top

laminat  
topveneer top

**returns & bridges** custom length return and bridge sizes are available up to 65" with the grain direction running lengthwise (opposite the desk grain), add \$452 list and specify length.  
\$217 list upcharge for (TH) Typing Height  
\$138 list upcharge for putting any additional pulls on a 2300/2100 unit → allegro → forte → presto



ovation/bravo | 2300 series  
2100 series

| wood top, veneer chassis, veneer drawer fronts  
| laminate top, veneer chassis, veneer drawer fronts



ovation/bravo  
2300/2100

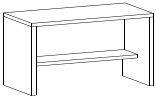
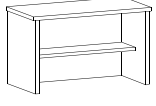
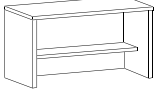
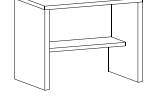
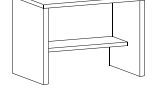
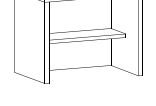
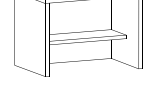
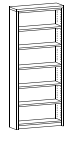
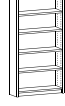



	model number	description		freight	list \$ zone 1	zone 2
	<b>CRP23483Q</b> - _ - _ - _  <b>CRP21483Q</b> - _ - _ - _	computer printer stand with one fixed shelf  <i>SPECIFY FOR LOCKING DUAL WHEEL CASTERS FOR UNIT HEIGHT OF 26.25" \$28</i> <i>SPECIFY FOR LOCKING DUAL WHEEL CASTERS FOR UNIT HEIGHT OF 28.25" \$28</i>	24 48 26.25 <i>KNEESPACE: 45"</i>	class 150 cwt 125 lb cu ft 22	<b>1,880 W</b>  <b>1,596 P</b>	<b>2,022 W</b>  <b>1,717 P</b>
	<b>CRP2348FM-29</b> - _ - _ - _  <b>CRP2148FM-29</b> - _ - _ - _	computer printer stand with one fixed shelf	24 48 29 <i>KNEESPACE: 45"</i>	class 150 cwt 125 lb cu ft 22	<b>1,880 W</b>  <b>1,596 P</b>	<b>2,022 W</b>  <b>1,717 P</b>
	<b>CRP2348FM</b> - _ - _ - _  <b>CRP2148FM</b> - _ - _ - _	computer printer stand with one fixed shelf  <i>SPECIFY FOR LOCKING DUAL WHEEL CASTERS FOR UNIT HEIGHT OF 26.25" \$28</i> <i>SPECIFY FOR LOCKING DUAL WHEEL CASTERS FOR UNIT HEIGHT OF 28.25" \$28</i>	24 48 26.25 <i>KNEESPACE: 45"</i>	class 150 cwt 125 lb cu ft 22	<b>1,880 W</b>  <b>1,596 P</b>	<b>2,022 W</b>  <b>1,717 P</b>
	<b>CRP23363Q-29</b> - _ - _ - _  <b>CRP21363Q-29</b> - _ - _ - _	computer printer stand with one fixed shelf	24 36 29 <i>KNEESPACE: 33"</i>	class 125 cwt 115 lb cu ft 17	<b>1,345 W</b>  <b>1,142 P</b>	<b>1,448 W</b>  <b>1,228 P</b>
	<b>CRP23363Q</b> - _ - _ - _  <b>CRP21363Q</b> - _ - _ - _	computer printer stand with one fixed shelf  <i>SPECIFY FOR LOCKING DUAL WHEEL CASTERS FOR UNIT HEIGHT OF 26.25" \$28</i> <i>SPECIFY FOR LOCKING DUAL WHEEL CASTERS FOR UNIT HEIGHT OF 28.25" \$28</i>	24 36 26.25 <i>KNEESPACE: 33"</i>	class 125 cwt 115 lb cu ft 17	<b>1,345 W</b>  <b>1,142 P</b>	<b>1,448 W</b>  <b>1,228 P</b>
	<b>CRP2336FM-29</b> - _ - _ - _  <b>CRP2136FM-29</b> - _ - _ - _	computer printer stand with one fixed shelf	24 36 29 <i>KNEESPACE: 33"</i>	class 125 cwt 115 lb cu ft 17	<b>1,345 W</b>  <b>1,142 P</b>	<b>1,448 W</b>  <b>1,228 P</b>
	<b>CRP2336FM</b> - _ - _ - _  <b>CRP2136FM</b> - _ - _ - _	computer printer stand with one fixed shelf  <i>SPECIFY FOR LOCKING DUAL WHEEL CASTERS FOR UNIT HEIGHT OF 26.25" \$28</i> <i>SPECIFY FOR LOCKING DUAL WHEEL CASTERS FOR UNIT HEIGHT OF 28.25" \$28</i>	24 36 26.25 <i>KNEESPACE: 33"</i>	class 125 cwt 115 lb cu ft 17	<b>1,345 W</b>  <b>1,142 P</b>	<b>1,448 W</b>  <b>1,228 P</b>
	<b>BC2384</b> - _ - _ - _  <b>BC2184</b> - _ - _ - _	bookcase four adjustable shelves one fixed shelf in center  <i>ADDITIONAL SHELVES (EACH) \$92</i> <i>SOLID WOOD SHELVES (EACH) \$434</i>	12 36 84	class 125 cwt 145 lb cu ft 24	<b>1,774 W</b>  <b>1,508 P</b>	<b>1,910 W</b>  <b>1,621 P</b>
	<b>BC2372</b> - _ - _ - _  <b>BC2172</b> - _ - _ - _	bookcase three adjustable shelves one fixed shelf in center  <i>ADDITIONAL SHELVES (EACH) \$92</i> <i>SOLID WOOD SHELVES (EACH) \$434</i>  Quick Ship available in 8DC dark cherry with B edge	12 36 72	class 125 cwt 130 lb cu ft 24	<b>1,566 W</b>  <b>1,330 P</b>	<b>1,618 W</b>  <b>1,433 P</b>

[ QS ]

**chassis models**

<b>3Q</b> 3/4 pedestal 3/4 modesty	<b>laminate</b> tops only	<b>3L-P</b> saddle on walnut <b>4L-P</b> dark mahogany on walnut <b>25M-P</b> mahogany on walnut <b>25B-P</b> ebony on walnut <b>25C-P</b> cherry on walnut <b>2ML-P</b> natural maple <b>3ML-P</b> light maple <b>4ML-P</b> medium maple <b>5ML-P</b> cherry on maple <b>6LC-P</b> light cherry on cherry <b>7MC-P</b> medium cherry on cherry <b>8DC-P</b> dark cherry on cherry	<b>veneer</b> top and chassis finish	<b>3L-W</b> saddle on walnut <b>2KL-W</b> sepia on walnut <b>4L-W</b> dark mahogany on walnut <b>25M-W</b> mahogany on walnut <b>25B-W</b> ebony on walnut <b>25C-W</b> cherry on walnut <b>2ML-W</b> natural maple <b>3ML-W</b> light maple <b>4ML-W</b> medium maple <b>5ML-W</b> cherry on maple <b>6LC-W</b> light cherry on cherry <b>1NC-W</b> natural cherry on cherry <b>2HC-W</b> honey cherry on cherry	<b>7MC-W</b> medium cherry on cherry <b>8DC-W</b> dark cherry on cherry <b>9BC-W</b> burgundy cherry on cherry
---------------------------------------	------------------------------	---	---	---	--



	model number	description	d	w	h	freight	list \$ zone 1	list \$ zone 2
	<b>BC2360</b> - _ - _ - _	bookcase two adjustable shelves one fixed shelf in center	12	36	60	class 125 cwt 115 lb cu ft 20	<b>1,426</b>	<b>1,536</b>
	<b>BC2160</b> - _ - _ - _	ADDITIONAL SHELVES (EACH) <b>\$92</b> SOLID WOOD SHELVES (EACH) <b>\$434</b>					<b>1,213</b>	<b>1,305</b>
	<b>BC2348</b> - _ - _ - _	bookcase one adjustable shelf one fixed shelf	12	36	48	class 125 cwt 96 lb cu ft 16	<b>1,234</b>	<b>1,330</b>
	<b>BC2148</b> - _ - _ - _	ADDITIONAL SHELVES (EACH) <b>\$92</b> SOLID WOOD SHELVES (EACH) <b>\$434</b>					<b>1,050</b>	<b>1,129</b>
	<b>BC2336</b> - _ - _ - _	bookcase two adjustable shelves	12	36	36	class 125 cwt 85 lb cu ft 12	<b>1,078</b>	<b>1,161</b>
	<b>BC2136</b> - _ - _ - _	ADDITIONAL SHELVES (EACH) <b>\$92</b> SOLID WOOD SHELVES (EACH) <b>\$434</b>					<b>916</b>	<b>986</b>
	<b>BC2330</b> - _ - _ - _	bookcase one adjustable shelf	12	36	30	class 125 cwt 80 lb cu ft 11	<b>1,010</b>	<b>1,087</b>
	<b>BC2130</b> - _ - _ - _	ADDITIONAL SHELVES (EACH) <b>\$92</b> SOLID WOOD SHELVES (EACH) <b>\$434</b>					<b>858</b>	<b>924</b>

top

laminat  
topveneer top

\$138 list upcharge for putting any additional pulls on a  
2300/2100 unit → allegro → forte → presto



ovation/bravo | 2300 series  
2100 series

| wood top, veneer chassis, veneer drawer fronts  
| laminate top, veneer chassis, veneer drawer fronts





ovation/bravo  
2300/2100

	model number	description		freight	list \$ zone 1	zone 2
	<b>TD2372</b> - _ - _ - _	desk transaction counter for use with 72" desk unit only	12 72 15.25	class 85 cwt 90 lb cu ft 6	<b>1,118 W</b>	<b>1,202 W</b>
	<b>TD2172</b> - _ - _ - _				<b>1,118 P</b>	<b>1,202 P</b>
	<b>TD2366</b> - _ - _ - _	desk top transaction counter for use with 66" desk unit only	12 66 15.25	class 85 cwt 84 lb cu ft 6	<b>1,118 W</b>	<b>1,202 W</b>
	<b>TD2166</b> - _ - _ - _				<b>1,118 P</b>	<b>1,202 P</b>
	<b>TD236630</b> - _ - _ - _	desk top transaction counter for use with 30"x66" desk unit only	12 66 15.25	class 85 cwt 84 lb cu ft 6	<b>1,118 W</b>	<b>1,202 W</b>
	<b>TD216630</b> - _ - _ - _				<b>1,118 P</b>	<b>1,202 P</b>
	<b>TM2372R</b> - _ - _ - _	desk top transaction/reception gallery for use with 72" "I" unit	12 72 15.25	class 85 cwt 100 lb cu ft 8	<b>1,653 W</b>	<b>1,777 W</b>
	<b>TM2172R</b> - _ - _ - _	GALLERY 84x72x14			<b>1,653 P</b>	<b>1,777 P</b>
	<b>TM2372L</b> - _ - _ - _	desk top transaction/reception gallery for use with 72" "I" unit	12 72 15.25	class 85 cwt 100 lb cu ft 8	<b>1,653 W</b>	<b>1,777 W</b>
	<b>TM2172L</b> - _ - _ - _	GALLERY 84x72x14			<b>1,653 P</b>	<b>1,777 P</b>
	<b>TM2366R</b> - _ - _ - _	desk top transaction/reception gallery for use with 66" "I" unit	12 66 15.25	class 85 cwt 100 lb cu ft 8	<b>1,653 W</b>	<b>1,777 W</b>
	<b>TM2166R</b> - _ - _ - _	GALLERY 84x66x14			<b>1,653 P</b>	<b>1,777 P</b>
	<b>TM2366L</b> - _ - _ - _	desk top transaction/reception gallery for use with 66" "I" unit	12 66 15.25	class 85 cwt 100 lb cu ft 8	<b>1,653 W</b>	<b>1,777 W</b>
	<b>TM2166L</b> - _ - _ - _	GALLERY 84x66x14			<b>1,653 P</b>	<b>1,777 P</b>
	<b>TM236630R</b> - _ - _ - _	desk top transaction/reception gallery for use with 30"x66" "I" unit	12 66 15.25	class 85 cwt 94 lb cu ft 8	<b>1,653 W</b>	<b>1,777 W</b>
	<b>TM216630R</b> - _ - _ - _	GALLERY 78x66x14			<b>1,653 P</b>	<b>1,777 P</b>
	<b>TM236630L</b> - _ - _ - _	desk top transaction/reception gallery for use with 30"x66" "I" unit	12 66 15.25	class 85 cwt 94 lb cu ft 8	<b>1,653 W</b>	<b>1,777 W</b>
	<b>TM216630L</b> - _ - _ - _	GALLERY 78x66x14			<b>1,653 P</b>	<b>1,777 P</b>

**chassis models**

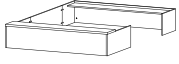
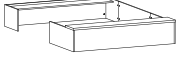
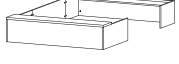
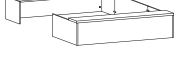
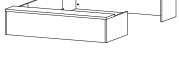
<b>3Q</b> 3/4 pedestal 3/4 modesty	<b>laminate</b> tops only	<b>3L-P</b> saddle on walnut <b>4L-P</b> dark mahogany on walnut <b>25M-P</b> mahogany on walnut <b>25B-P</b> ebony on walnut <b>25C-P</b> cherry on walnut <b>2ML-P</b> natural maple <b>3ML-P</b> light maple <b>4ML-P</b> medium maple <b>5ML-P</b> cherry on maple <b>6LC-P</b> light cherry on cherry <b>7MC-P</b> medium cherry on cherry <b>8DC-P</b> dark cherry on cherry	<b>veneer</b> top and chassis finish	<b>3L-W</b> saddle on walnut <b>2KL-W</b> sepia on walnut <b>4L-W</b> dark mahogany on walnut <b>25M-W</b> mahogany on walnut <b>25B-W</b> ebony on walnut <b>25C-W</b> cherry on walnut <b>2ML-W</b> natural maple <b>3ML-W</b> light maple <b>4ML-W</b> medium maple <b>5ML-W</b> cherry on maple <b>6LC-W</b> light cherry on cherry <b>1NC-W</b> natural cherry on cherry <b>2HC-W</b> honey cherry on cherry	<b>7MC-W</b> medium cherry on cherry <b>8DC-W</b> dark cherry on cherry <b>9BC-W</b> burgundy cherry on cherry
---------------------------------------	------------------------------	---	---	---	--

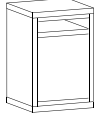
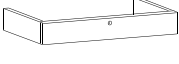
	model number	description	d	w	h	freight	list \$ zone 1	list \$ zone 2
	TU2372R - _ - _ - _	desk top transaction/reception gallery for use with 72" executive height "u" unit  <i>GALLERY 104x72x14</i>	12	72	15.25	class 85 cwt 150 lb cu ft 10	<b>2,234 W</b>	<b>2,406 W</b>
	TU2172R - _ - _ - _						<b>2,234 P</b>	<b>2,406 P</b>
	TU2372L - _ - _ - _	desk top transaction/reception gallery for use with 72" executive height "u" unit  <i>GALLERY 104x72x14</i>	12	72	15.25	class 85 cwt 150 lb cu ft 10	<b>2,234 W</b>	<b>2,406 W</b>
	TU2172L - _ - _ - _						<b>2,234 P</b>	<b>2,406 P</b>
	TU2366R - _ - _ - _	desk top transaction/reception gallery for use with 66" executive height "u" unit  <i>GALLERY 104x66x14</i>	12	66	15.25	class 85 cwt 140 lb cu ft 10	<b>2,234 W</b>	<b>2,406 W</b>
	TU2166R - _ - _ - _						<b>2,234 P</b>	<b>2,406 P</b>
	TU2366L - _ - _ - _	desk top transaction/reception gallery for use with 66" executive height "u" unit  <i>GALLERY 104x66x14</i>	12	66	15.25	class 85 cwt 140 lb cu ft 10	<b>2,234 W</b>	<b>2,406 W</b>
	TU2166L - _ - _ - _						<b>2,234 P</b>	<b>2,406 P</b>
	TU236630R - _ - _ - _	desk top transaction/reception gallery for use with 30"x66" executive height "u" unit  <i>GALLERY 98x66x14</i>	12	66	15.25	class 85 cwt 140 lb cu ft 10	<b>2,234 W</b>	<b>2,406 W</b>
	TU216630R - _ - _ - _						<b>2,234 P</b>	<b>2,406 P</b>
	TU236630L - _ - _ - _	desk top transaction/reception gallery for use with 30"x66" executive height "u" unit  <i>GALLERY 98x66x14</i>	12	66	15.25	class 85 cwt 140 lb cu ft 10	<b>2,234 W</b>	<b>2,406 W</b>
	TU216630L - _ - _ - _						<b>2,234 P</b>	<b>2,406 P</b>
	SC2137 - _ - _ - _	serving cart with hinged doors one adjustable shelf  <i>ADDITIONAL SHELVES (EACH) \$92</i> <i>SOLID WOOD SHELVES (EACH) \$434</i>	20	36.6	30.5	class 125 cwt 185 lb cu ft 16	<b>2,440 P</b>	<b>2,636 P</b>
	TC2320 - _ - _ - _	telephone cabinet opening with hinged door 1 adjustable shelf	19	19	29	class 125 cwt 75 lb cu ft 6	<b>1,375 W</b>	<b>1,487 W</b>
	TC2120 - _ - _ - _	<i>ADDITIONAL SHELVES (EACH) \$92</i> <i>SOLID WOOD SHELVES (EACH) \$434</i>					<b>1,190 P</b>	<b>1,284 P</b>
	KBKD2300 - _ - _ - _	flip-front keyboard drawer factory installed only	14	custom		class cwt lb cu ft	<b>585</b>	<b>636</b>
	KBKD2100 - _ - _ - _	<i>SPECIFY A GROMMET LOCATION</i>	3.5				<b>585</b>	<b>636</b>

top

laminat  
topveneer top

\$138 list upcharge for putting any additional pulls on a  
2300/2100 unit → allegro → forte → presto



ovation/bravo | 2300 series  
2100 series

| wood top, veneer chassis, veneer drawer fronts  
| laminate top, veneer chassis, veneer drawer fronts



ovation/bravo  
2300/2100

	model number	description		freight	list \$ zone 1	zone 2
	LT2348 - _ - _ - _	coffee table with wood legs <i>CAN SHIP UPS</i>	18.9 48 15	class 85 cwt 50 lb cu ft 6	812	876
	LT2148 - _ - _ - _				575	621
	LT2348-29 - _ - _ - _	coffee table with wood legs <i>CAN SHIP UPS</i>	18 48 29	class 18 cwt 48 lb cu ft 29	1,036	1,114
	LT2148-29 - _ - _ - _				795	863
	LT2330 - _ - _ - _	lamp table with wood legs <i>CAN SHIP UPS</i>	18 30 22	class 85 cwt 30 lb cu ft 3	647	697
	LT2130 - _ - _ - _				468	508
	LT2324 - _ - _ - _	lamp table with wood legs <i>CAN SHIP UPS</i>	24 24 22	class cwt lb cu ft	647	697
	LT2124 - _ - _ - _				468	508
	TL24	task light for use with overhead storage units <i>FIELD INSTALLED ONLY</i>	7 24 2	class 100 cwt 11 lb cu ft 1	335	364
	HMS48 - _ PLB - _	half moon top with wood post legs <i>(4) PLB FOR ABOVE TOP</i>	24 48	class cwt 35 lb cu ft 11	2,282	2,460
	HMS48 - _ PLB - _					
	EV7236 - _ XB-24 - _	elliptical top with x wood base <i>(2) WOOD X BASES FOR ABOVE</i>	72 36	class cwt 105 lb cu ft 70	3,175	3,423
	EV7236 - _ XB-24 - _					
	SO42 - _ - _ PDB-24 - _ - _	square top with post disc base base available in stardust or black	42 42	class cwt 50 lb cu ft	2,500	2,652
	SO42 - _ - _ PDB-24 - _ - _					

**chassis models**

**3Q** 3/4 pedestal  
3/4 modesty  
**FM** 3/4 pedestal  
full modesty  
**FP** full pedestal  
full modesty

**laminate**  
tops only

**3L-P** saddle on walnut  
**4L-P** dark mahogany on walnut  
**25M-P** mahogany on walnut  
**25B-P** ebony on walnut  
**25C-P** cherry on walnut  
**2ML-P** natural maple  
**3ML-P** light maple  
**4ML-P** medium maple  
**5ML-P** cherry on maple  
**6LC-P** light cherry on cherry  
**7MC-P** medium cherry on cherry  
**8DC-P** dark cherry on cherry

**veneer**  
top and  
chassis  
finish

**3L-W** saddle on walnut  
**2KL-W** sepia on walnut  
**4L-W** dark mahogany on walnut  
**25M-W** mahogany on walnut  
**25B-W** ebony on walnut  
**25C-W** cherry on walnut  
**2ML-W** natural maple  
**3ML-W** light maple  
**4ML-W** medium maple  
**5ML-W** cherry on maple  
**6LC-W** light cherry on cherry  
**1NC-W** natural cherry on cherry  
**2HC-W** honey cherry on cherry

**7MC-W** medium cherry on cherry  
**8DC-W** dark cherry on cherry  
**9BC-W** burgundy cherry on cherry

# inwood

OFFICE  
ENVIRONMENTS

## price list

effective 01 january 2012

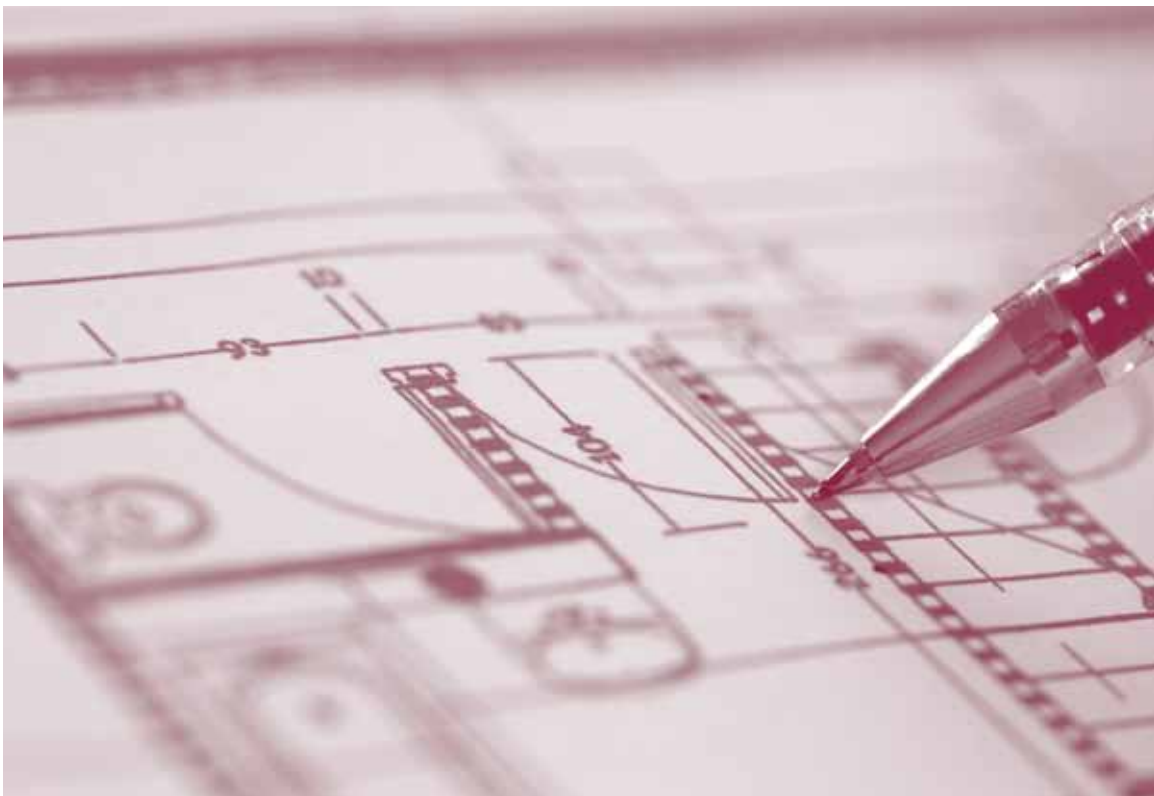

account # \_\_\_\_\_  
discount \_\_\_\_\_  
zone \_\_\_\_\_  
c.s.r. \_\_\_\_\_  
sales rep. \_\_\_\_\_

veer  
1400

[click here for warranty  
and terms information](#)

zones one and two



# inwood

OFFICE  
ENVIRONMENTS

---



veer  
1400

**veer 1400 series specifications****materials:**

All wood is thoroughly air and kiln dried to a moisture content not to exceed 8% at the time of assembly.

**veneers:**

All exposed surfaces are plain sliced cherry. Veneers are carefully slip-matched and balanced. All drawer fronts, doors, end panels, and modesty panels have vertical grain so that all wood grain runs the same direction on all items.

**top work surfaces:**

Wood veneer tops are 1 1/16" thick, 3-ply construction, consisting of 1/40" thick cherry veneer work surface and a gator-ply backing. The top core material is a 45 lb medium density fiberboard, with an optional edge detail on approach side only of desks and user side only of double pedestal credenzas. Optional plastic laminate tops 1 1/4" thick, 3-ply construction, consisting of a high pressure laminate work surface and a 45 lb density flake board core and a gator-ply backing. Tops are flush with end panels and pedestals (no overhang).

**modesty panels:**

Recessed 3/4" thick, 3-ply construction with a vertical veneer on exposed surfaces and a 45 lb density particle board core. An optional "mesh" panel can be attached to the flare tops. This modesty consists of a black wood frame with an insert of mesh fabric.

**construction:**

Uses mitered corners and glue to join pedestal sides and back. All joints are reinforced with glue blocks. All pedestals have box drawer, file drawer, with curved route finger inset drawer pulls. Each pedestal has a lock and is keyed alike.

**drawers:**

Drawer fronts are 3/4" thick, 3-ply construction with vertical slip matched veneer. Drawer edges are veneered on top with mitered sides with matching wood veneer. All drawer sides and backs are plywood, dovetailed front and back. Drawer bottoms are framed on four sides and stapled from the bottom side. Box drawers have a high grade Sterling metal ball-bearing telescoping drawer suspension. File drawers have a high grade Sterling metal ball bearing full progressive suspension and are equipped with metal rods for hanging file folders. All drawers have smooth quiet operation.

*NOTE: Optional center drawers available.*

**inside drawer dimensions:**

box drawers: 4" H x 12 1/8" W x 15 9/16" L  
4" H x 12 1/8" W x 22 1/8" L  
file drawers: 9 1/2" H x 12 1/8" W x 15 9/16" L  
9 1/2" H x 12 1/8" W x 25 3/8" L  
lateral files: 9 1/2" H x 32 5/8" W x 16" L

**locking:**

Each pedestal has its own lock and is keyed alike on each unit. Each unit is equipped with two keys. Units may be keyed alike for an upcharge.

**finish:**

All inwood finishes are a catalyzed varnish finish. Our multi-step satin finishes leave an open grain natural look to the furniture. Available in the following finishes: (6LC) light cherry on cherry, (7MC) medium cherry on cherry, (8DC) dark cherry on cherry. These colors are also available on matching high pressure laminate tops with veneer chassis.



**veer**

**desks**

letter  
front to back

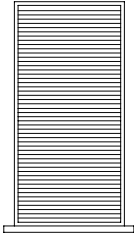

letter  
side to side

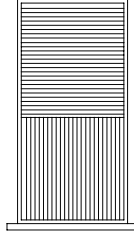

letter/legal  
combination

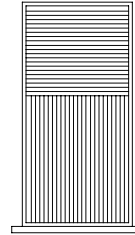

**returns  
and  
credenzas**

letter  
front to back

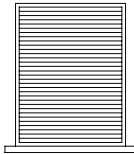

letter  
side to side

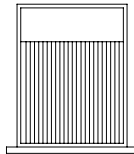

**lateral files**

letter  
front to back

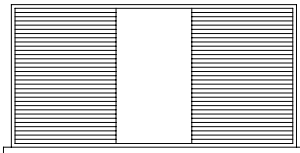

legal  
front to back

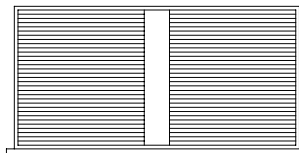

letter  
side to side

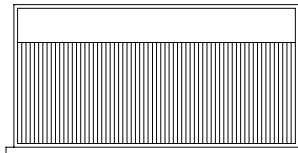

legal  
side to side

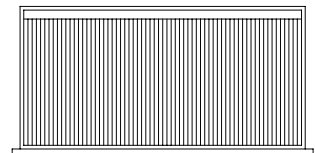



## F1472FP-6LC-P

unit identification (type), top dimension, chassis option - chassis & top finish - top material

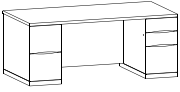
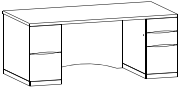
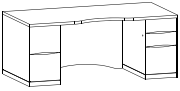
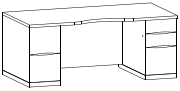
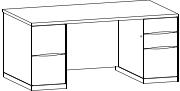
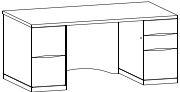
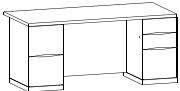
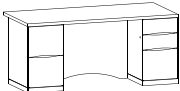
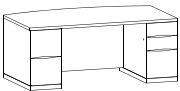
	model number	description	d w h	freight	list \$ zone 1	list \$ zone 2
	F1472 - _ - _	double pedestal desk left file/file right box/box/file <i>CHROME HIGHLIGHT ON MODESTY PANEL (LIST) \$154</i>	36 72 29 <i>KNEESPACE: 41"</i>	class 125 cwt 325 lb cu ft 53	2,954 W  2,625 P	3,190 W  2,836 P
	F1472-AM - _ - _	double pedestal desk with arc modesty left file/file right box/box/file	36 72 29 <i>KNEESPACE: 41"</i>	class 125 cwt 325 lb cu ft 53	3,237 W  2,909 P	3,497 W  3,141 P
	F1472A-AM - _ - _	double pedestal desk with arc modesty and acr top (user side) left file/file right box/box/file	36 72 29 <i>KNEESPACE: 41"</i>	class 125 cwt 325 lb cu ft 53	3,521 W  3,192 P	3,803 W  3,448 P
	F1472A - _ - _	double pedestal desk with arc top (user side) left file/file right box/box/file <i>CHROME HIGHLIGHT ON MODESTY PANEL (LIST) \$154</i>	36 72 29 <i>KNEESPACE: 41"</i>	class 125 cwt 325 lb cu ft 53	3,237 W  2,909 P	3,497 W  3,141 P
	F1466 - _ - _	double pedestal desk left file/file right box/box/file <i>CHROME HIGHLIGHT ON MODESTY PANEL (LIST) \$154</i>	36 66 29 <i>KNEESPACE: 35"</i>	class 125 cwt 310 lb cu ft 48	2,933 W  2,608 P	3,166 W  2,816 P
	F1466-AM - _ - _	double pedestal desk with arc modesty left file/file right box/box/file	36 66 29 <i>KNEESPACE: 35"</i>	class 125 cwt 310 lb cu ft 48	3,215 W  2,892 P	3,472 W  3,123 P
	F146630 - _ - _	double pedestal desk left file/file right box/box/file <i>CHROME HIGHLIGHT ON MODESTY PANEL (LIST) \$154</i>	36 66 29 <i>APPROACH: 9.5"</i> <i>KNEESPACE: 35"</i>	class 125 cwt 310 lb cu ft 48	2,810 W  2,490 P	3,035 W  2,689 P
	F146630-AM - _ - _	double pedestal desk with arc modesty left file/file right box/box/file	36 66 29 <i>APPROACH: 9.5"</i> <i>KNEESPACE: 35"</i>	class 125 cwt 310 lb cu ft 48	3,094 W  2,773 P	3,341 W  2,995 P
	FBT1472 - _ - _	bowfront double pedestal desk left file/file right box/box/file <i>CHROME HIGHLIGHT ON MODESTY PANEL (LIST) \$154</i>	42 72 29 <i>APPROACH: 9.5"</i> <i>KNEESPACE: 41"</i>	class 125 cwt 370 lb cu ft 55	3,985 W  3,294 P	4,303 W  3,557 P

top

P laminate top  
W wood top

pulls routed out (curved) finger pull standard

edge





veer

1400 series

laminated top, veneer chassis, veneer drawer fronts  
 veneer top, veneer chassis, veneer drawer fronts

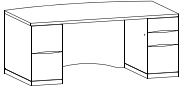
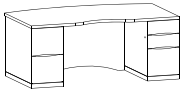
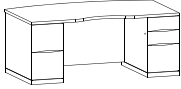
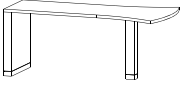
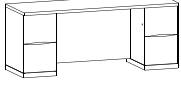
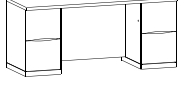
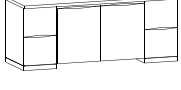

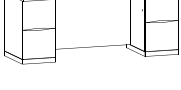
	model number	description	d w h	freight	list \$ zone 1	zone 2
	<b>FBT1472-AM</b> - _ - _	bowfront double pedestal desk with arc modesty left file/file right box/box/file	42 72 29  <i>APPROACH: 9.5"</i> <i>KNEESPACE: 41"</i>	class 125 cwt 370 lb cu ft 55	<b>4,269 W</b>  <b>3,577 P</b>	<b>4,610 W</b>  <b>3,864 P</b>
	<b>FBT1472A-AM</b> - _ - _	bowfront double pedestal desk with arc modesty and arc top (user side) left file/file right box/box/file	42 72 29  <i>APPROACH: 9.5"</i> <i>KNEESPACE: 41"</i>	class 125 cwt 370 lb cu ft 55	<b>4,552 W</b>  <b>3,861 P</b>	<b>4,916 W</b>  <b>4,169 P</b>
	<b>FBT1472A</b> - _ - _	bowfront double pedestal desk with arc top (user side) left file/file right box/box/file <i>CHROME HIGHLIGHT ON MODESTY PANEL (LIST) \$154</i>	42 72 29  <i>APPROACH: 9.5"</i> <i>KNEESPACE: 41"</i>	class 125 cwt 370 lb cu ft 55	<b>4,269 W</b>  <b>3,577 P</b>	<b>4,610 W</b>  <b>3,864 P</b>
	<b>E1472</b> - _ - _	flare extension top with wood square leg <i>MESH MODESTY (BLACK ONLY), ADD UPCHARGE (LIST) \$711</i>	24-36 72 29	class 125 cwt 100 lb cu ft 9	<b>1,926 W</b>  <b>1,618 P</b>	<b>2,078 W</b>  <b>1,747 P</b>
	<b>CR1472</b> - _ - _	double pedestal credenza left and right file/file pedestals	24 72 29  <i>KNEESPACE: 41"</i>	class 125 cwt 250 lb cu ft 28	<b>2,145 W</b>  <b>1,970 P</b>	<b>2,316 W</b>  <b>2,127 P</b>
	<b>CR1466</b> - _ - _	double pedestal credenza left and right file/file pedestals	24 66 29  <i>KNEESPACE: 35"</i>	class 125 cwt 250 lb cu ft 28	<b>2,085 W</b>  <b>1,904 P</b>	<b>2,251 W</b>  <b>2,057 P</b>
	<b>CR1472D</b> - _ - _	double pedestal storage credenza left and right file/file pedestals hinged doors with 1 adjustable shelf in center  <i>SOLID WOOD SHELVES (EACH) \$28</i> <i>ADDITIONAL SHELVES (EACH) \$92</i>	24 72 29	class 125 cwt 260 lb cu ft 28	<b>2,466 W</b>  <b>2,291 P</b>	<b>2,663 W</b>  <b>2,475 P</b>
	<b>CR1466D</b> - _ - _	double pedestal storage credenza left and right file/file pedestals hinged doors with 1 adjustable shelf in center  <i>SOLID WOOD SHELVES (EACH) \$28</i> <i>ADDITIONAL SHELVES (EACH) \$92</i>	24 66 29	class 125 cwt 260 lb cu ft 28	<b>2,387 W</b>  <b>2,206 P</b>	<b>2,578 W</b>  <b>2,383 P</b>
	<b>CR1472A</b> - _ - _	double pedestal credenza with arc top (user side) left and right file/file pedestals	24 72 29  <i>KNEESPACE: 41"</i>	class 125 cwt 250 lb cu ft 28	<b>2,426 W</b>  <b>2,251 P</b>	<b>2,620 W</b>  <b>2,432 P</b>

**laminated**

- 6LC-P** light cherry on cherry laminate
- 7MC-P** medium cherry on cherry laminate
- 8DC-P** dark cherry on cherry laminate

**veener**  
tops only

- 6LC-W** light cherry on cherry veneer
- 7MC-W** medium cherry on cherry veneer
- 8DC-W** dark cherry on cherry veneer

veer 1400

## F1472FP-6LC-P

unit identification (type), top dimension, chassis option - **chassis & top finish** - top material

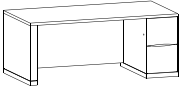
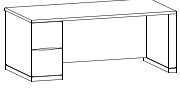
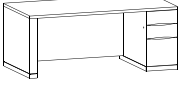
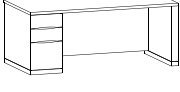
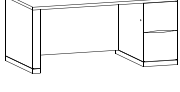
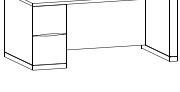
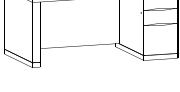
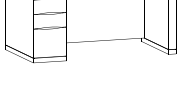
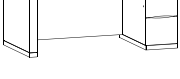
	model number	description	d w h	freight	list \$ zone 1	list \$ zone 2
	D1472R - _ - _	single pedestal desk right file/file pedestal	36 72 29 <i>KNEESPACE: 53"</i>	class 125 cwt 270 lb cu ft 53	2,370 W  2,042 P	2,561 W  2,205 P
	D1472L - _ - _	single pedestal desk left file/file pedestal	36 72 29 <i>KNEESPACE: 53"</i>	class 125 cwt 270 lb cu ft 53	2,370 W  2,042 P	2,561 W  2,205 P
	D1472R-3D - _ - _	single pedestal desk right box/box/file pedestal	36 72 29 <i>KNEESPACE: 53"</i>	class 125 cwt 290 lb cu ft 53	2,641 W  2,311 P	2,852 W  2,496 P
	D1472L-3D - _ - _	single pedestal desk left box/box/file pedestal	36 72 29 <i>KNEESPACE: 53"</i>	class 125 cwt 290 lb cu ft 53	2,641 W  2,311 P	2,852 W  2,496 P
	D1466R - _ - _	single pedestal desk right file/file pedestal	36 66 29 <i>KNEESPACE: 47"</i>	class 125 cwt 270 lb cu ft 53	2,360 W  2,032 P	2,549 W  2,194 P
	D1466L - _ - _	single pedestal desk left file/file pedestal	36 66 29 <i>KNEESPACE: 47"</i>	class 125 cwt 270 lb cu ft 53	2,360 W  2,032 P	2,549 W  2,194 P
	D1466R-3D - _ - _	single pedestal desk right box/box/file pedestal	36 66 29 <i>KNEESPACE: 47"</i>	class 125 cwt 270 lb cu ft 53	2,657 W  2,329 P	2,869 W  2,521 P
	D1466L-3D - _ - _	single pedestal desk left box/box/file pedestal	36 66 29 <i>KNEESPACE: 47"</i>	class 125 cwt 270 lb cu ft 53	2,657 W  2,329 P	2,869 W  2,521 P
	DBT1472R - _ - _	bowfront single pedestal desk right file/file pedestal	42 72 29 <i>APPROACH: 9.5"</i> <i>KNEESPACE: 53"</i>	class 125 cwt 295 lb cu ft 55	3,040 W  2,384 P	3,283 W  2,574 P

top

**P** laminate top  
**W** wood top

**pulls** routed out (curved) finger pull standard

edge



veer

1400 series

laminated top, veneer chassis, veneer drawer fronts  
 veneer top, veneer chassis, veneer drawer fronts



	model number	description	d w h	freight	list \$ zone 1	zone 2
	DBT1472L - _ - _	bowfront single pedestal desk left file/file pedestal	42 72 29  APPROACH: 9.5" KNEESPACE: 53"	class 125 cwt 295 lb cu ft 55	3,040 W  2,384 P	3,283 W  2,574 P
	DBT1472R-3D - _ - _	bowfront single pedestal desk right box/box/file pedestal	42 72 29  APPROACH: 9.5" KNEESPACE: 53"	class 125 cwt 295 lb cu ft 55	3,309 W  2,653 P	3,574 W  2,865 P
	DBT1472L-3D - _ - _	bowfront single pedestal desk left box/box/file pedestal	42 72 29  APPROACH: 9.5" KNEESPACE: 53"	class 125 cwt 295 lb cu ft 55	3,309 W  2,653 P	3,574 W  2,865 P
	DBT1472RA - _ - _	bowfront single pedestal desk with arc top (user side) right file/file pedestal	42 72 29  APPROACH: 9.5" KNEESPACE: 53"	class 125 cwt 295 lb cu ft 55	3,322 W  2,667 P	3,588 W  2,880 P
	DBT1472LA - _ - _	bowfront single pedestal desk with arc top (user side) left file/file pedestal	42 72 29  APPROACH: 9.5" KNEESPACE: 53"	class 125 cwt 295 lb cu ft 55	3,322 W  2,667 P	3,588 W  2,880 P
	DBT1472RA-3D - _ - _	bowfront single pedestal desk with arc top (user side) right box/box/file pedestal	42 72 29  APPROACH: 9.5" KNEESPACE: 53"	class 125 cwt 295 lb cu ft 55	3,591 W  2,937 P	3,879 W  3,171 P
	DBT1472LA-3D - _ - _	bowfront single pedestal desk with arc top (user side) left box/box/file pedestal	42 72 29  APPROACH: 9.5" KNEESPACE: 53"	class 125 cwt 295 lb cu ft 55	3,591 W  2,937 P	3,879 W  3,171 P
	D1472RA - _ - _	single pedestal desk with arc top (user side) right file/file pedestal	36 72 29  KNEESPACE: 53"	class 125 cwt 270 lb cu ft 53	2,654 W  2,326 P	2,867 W  2,511 P
	D1472LA - _ - _	single pedestal desk with arc top (user side) left file/file pedestal	36 72 29  KNEESPACE: 53"	class 125 cwt 270 lb cu ft 53	2,654 W  2,326 P	2,867 W  2,511 P

**laminated**

- 6LC-P light cherry on cherry laminated
- 7MC-P medium cherry on cherry laminated
- 8DC-P dark cherry on cherry laminated

**veener**  
tops only

- 6LC-W light cherry on cherry veneer
- 7MC-W medium cherry on cherry veneer
- 8DC-W dark cherry on cherry veneer

veer  
1400

## F1472FP-6LC-P

unit identification (type), top dimension, chassis option - **chassis & top finish** - top material

	model number	description	d w h	freight	list \$ zone 1	list \$ zone 2
	D1472RA-3D - __ - __	single pedestal desk with arc top (user side) right box/box/file pedestal	36 72 29 <i>KNEESPACE: 53"</i>	class 125 cwt 290 lb cu ft 53	2,923 W  2,595 P	3,137 W  2,781 P
	D1472LA-3D - __ - __	single pedestal desk with arc top (user side) left box/box/file pedestal	36 72 29 <i>KNEESPACE: 53"</i>	class 125 cwt 290 lb cu ft 53	2,923 W  2,595 P	3,137 W  2,781 P
	D146630R - __ - __	single pedestal desk right file/file pedestal	30 66 29 <i>KNEESPACE: 47"</i>	class 125 cwt 265 lb cu ft 40	2,280 W  1,959 P	2,462 W  2,117 P
	D146630L - __ - __	single pedestal desk left file/file pedestal	30 66 29 <i>KNEESPACE: 47"</i>	class 125 cwt 265 lb cu ft 40	2,280 W  1,959 P	2,462 W  2,117 P
	D146630R-3D - __ - __	single pedestal desk right box/box/file pedestal	30 66 29 <i>KNEESPACE: 47"</i>	class 125 cwt 265 lb cu ft 40	2,577 W  2,256 P	2,783 W  2,437 P
	D146630L-3D - __ - __	single pedestal desk left box/box/file pedestal	30 66 29 <i>KNEESPACE: 47"</i>	class 125 cwt 265 lb cu ft 40	2,577 W  2,256 P	2,783 W  2,437 P
	C1472R - __ - __	single pedestal credenza right box/box/file pedestal	24 72 29 <i>KNEESPACE: 53"</i>	class 125 cwt 225 lb cu ft 28	1,509 W  1,333 P	1,629 W  1,440 P
	C1472L - __ - __	single pedestal credenza left box/box/file pedestal	24 72 29 <i>KNEESPACE: 53"</i>	class 125 cwt 225 lb cu ft 28	1,509 W  1,333 P	1,629 W  1,440 P
	C1472RA - __ - __	single pedestal credenza with arc top (user side) right box/box.file pedestal	24 72 29 <i>KNEESPACE: 53"</i>	class 125 cwt 225 lb cu ft 28	1,792 W  1,617 P	1,935 W  1,746 P

top

**P** laminate top  
**W** wood top

**pulls** routed out (curved) finger pull standard

edge



veer

1400 series

laminated top, veneer chassis, veneer drawer fronts  
 veneer top, veneer chassis, veneer drawer fronts



	model number	description	d w h	freight	list \$ zone 1	zone 2
	C1472LA - _ - _	single pedestal credenza with arc top (user side) left box/box/file pedestal	24 72 29 <i>KNEESPACE: 53"</i>	class 125 cwt 225 lb cu ft 28	1,792 W  1,617 P	1,935 W  1,746 P
	C1466R - _ - _	single pedestal credenza right box/box/file pedestal	24 66 29 <i>KNEESPACE: 47"</i>	class 125 cwt 225 lb cu ft 28	1,501 W  1,321 P	1,621 W  1,427 P
	C1466L - _ - _	single pedestal credenza left box/box/file pedestal	24 66 29 <i>KNEESPACE: 47"</i>	class 125 cwt 225 lb cu ft 28	1,501 W  1,321 P	1,621 W  1,427 P
	C1472R-2F - _ - _	single pedestal credenza right lateral file pedestal	24 72 29 <i>KNEESPACE: 32.5"</i>	class 125 cwt 228 lb cu ft 28	2,176 W  2,042 P	2,350 W  2,205 P
	C1472L-2F - _ - _	single pedestal credenza left lateral file pedestal	24 72 29 <i>KNEESPACE: 32.5"</i>	class 125 cwt 228 lb cu ft 28	2,176 W  2,042 P	2,350 W  2,205 P
	C1466R-2F - _ - _	single pedestal credenza right lateral file pedestal	24 66 29 <i>KNEESPACE: 26.5"</i>	class 125 cwt 228 lb cu ft 28	1,984 W  1,851 P	2,142 W  1,999 P
	C1466L-2F - _ - _	single pedestal credenza left lateral file pedestal	24 66 29 <i>KNEESPACE: 26.5"</i>	class 125 cwt 228 lb cu ft 28	1,984 W  1,851 P	2,142 W  1,999 P
	B1448 - _ - _	bridge	24 48 29 <i>KNEESPACE: 48"</i>	class 125 cwt 65 lb cu ft 6	1,050 W  558 P	1,133 W  603 P
	R1448R - _ - _	return with right box/box/file pedestal	24 48 29 <i>KNEESPACE: 32.5"</i>	class 125 cwt 155 lb cu ft 23	1,526 W  1,246 P	1,647 W  1,348 P



**laminated**

6LC-P light cherry on cherry laminate  
 7MC-P medium cherry on cherry laminate  
 8DC-P dark cherry on cherry laminate

**veener**  
 tops only

6LC-W light cherry on cherry veneer  
 7MC-W medium cherry on cherry veneer  
 8DC-W dark cherry on cherry veneer

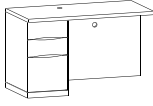
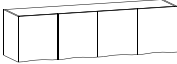
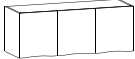
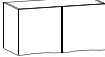
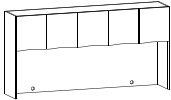
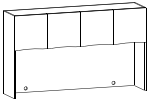
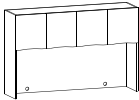
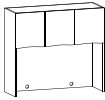
veer  
 1400

	model number	description	d	w	h	freight	list \$ zone 1	list \$ zone 2
	<b>R1448L</b> - _ - _	return with left box/box/file pedestal	24	48	29	class 125 cwt 155 lb cu ft 23  <i>KNEESPACE: 32.5"</i>	<b>1,526 W</b>  <b>1,246 P</b>	<b>1,647 W</b>  <b>1,348 P</b>
	<b>WH1466</b> - _ - _	66" wide wall hung overhead unit four hinged doors	16	66	16	class 125 cwt 110 lb cu ft 13	<b>1,792</b>	<b>1,935</b>
	<b>WH1448</b> - _ - _	48" wide wall hung overhead unit three hinged doors	16	48	16	class 125 cwt 90 lb cu ft 10	<b>1,541</b>	<b>1,665</b>
	<b>WH1436</b> - _ - _	36" wide wall hung overhead unit two hinged doors	16	36	16	class 125 cwt 75 lb cu ft 7	<b>1,010</b>	<b>1,090</b>
	<b>OU1484</b> - _ - _	overhead storage unit five hinged doors three wire management grommets	16.5	84	43	class 125 cwt 210 lb cu ft 40	<b>3,831</b>	<b>4,137</b>
	<b>OU1472</b> - _ - _	overhead storage unit four hinged doors three wire management grommets	16.5	72	43	class 125 cwt 210 lb cu ft 40	<b>3,050</b>	<b>3,294</b>
	<b>OU1466</b> - _ - _	overhead storage unit four hinged doors three wire management grommets	16.5	66	43	class 125 cwt 190 lb cu ft 38	<b>2,959</b>	<b>3,195</b>
	<b>OU1448</b> - _ - _	overhead storage unit three hinged doors three wire management grommets	16.5	48	43	class 125 cwt 150 lb cu ft 26	<b>2,282</b>	<b>2,464</b>
	<b>OU1436</b> - _ - _	overhead storage unit two hinged doors two wire management grommets	16.5	36	43	class 85 cwt 115 lb cu ft 19	<b>1,964</b>	<b>2,122</b>

top

**P** laminate top  
**W** wood top

**pulls** routed out (curved) finger pull standard

edge



veer

1400 series

laminated top, veneer chassis, veneer drawer fronts  
 veneer top, veneer chassis, veneer drawer fronts

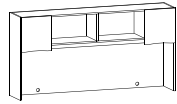

**model number**  
**OD1484** - \_ - \_

**description**  
 overhead storage unit  
 open center  
 one hinged door on each end  
 three wire management grommets

**d w h**  
 16.5 84 43

**freight**  
 class 125  
 cwt 200 lb  
 cu ft 40

**list \$ zone 1**  
**3,572**

**zone 2**  
**3,857**

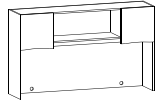

**OD1472** - \_ - \_

overhead storage unit  
 open center  
 one hinged door on each end  
 three wire management grommets

16.5 72 43

class 125  
 cwt 200 lb  
 cu ft 40

**2,790**

**3,013**

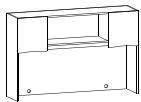

**OD1466** - \_ - \_

overhead storage unit  
 open center  
 one hinged door on each end  
 three wire management grommets

16.5 66 43

class 125  
 cwt 175 lb  
 cu ft 38

**2,699**

**2,914**

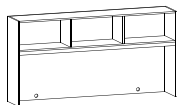

**OO1484** - \_ - \_

open overhead storage unit  
 three wire management grommets

16.5 84 43

class 125  
 cwt 195 lb  
 cu ft 40

**3,153**

**3,405**

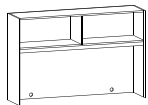

**OO1472** - \_ - \_

open overhead storage unit  
 three wire management grommets

16.5 72 43

class 125  
 cwt 195 lb  
 cu ft 40

**2,370**

**2,561**

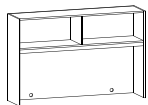

**OO1466** - \_ - \_

open overhead storage unit  
 three wire management grommets

16.5 66 43

class 125  
 cwt 170 lb  
 cu ft 38

**2,301**

**2,486**

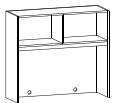

**OO1448** - \_ - \_

open overhead storage unit  
 three wire management grommets

16.5 48 43

class 125  
 cwt 115 lb  
 cu ft 19

**1,773**

**1,915**

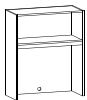

**OO1436** - \_ - \_

open overhead storage unit  
 two wire management grommets

16.5 36 43

class 125  
 cwt 110 lb  
 cu ft 26

**1,587**

**1,715**

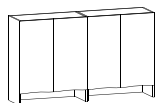

**HW1472-43** - \_ - \_

hinged door cabinet with two adjustable shelves  
 in each side with four doors  
*SOLID WOOD SHELVES (EACH) \$28*  
*ADDITIONAL SHELVES (EACH) \$92*

16.5 72 43

class 125  
 cwt 300 lb  
 cu ft 48

**4,576**

**4,941**

**laminated**





- 6LC-P** light cherry on cherry laminate
- 7MC-P** medium cherry on cherry laminate
- 8DC-P** dark cherry on cherry laminate

**veener**  
 tops only

- 6LC-W** light cherry on cherry veneer
- 7MC-W** medium cherry on cherry veneer
- 8DC-W** dark cherry on cherry veneer

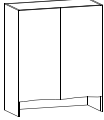
veer  
 1400

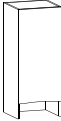
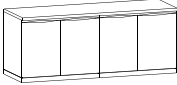
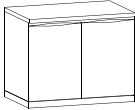

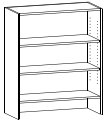
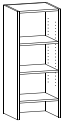
	model number	description	d	w	h	freight	list \$ zone 1	list \$ zone 2
	HW1436-43 - _ - _	hinged door cabinet with two adjustable shelves <i>SOLID WOOD SHELVES (EACH) \$28</i> <i>ADDITIONAL SHELVES (EACH) \$92</i>	16.5	36	43	class 125 cwt 125 lb cu ft 21	2,273	2,454
	HW1418R-43 - _ - _	hinged door cabinet with two adjustable shelves hinge on right <i>SOLID WOOD SHELVES (EACH) \$28</i> <i>ADDITIONAL SHELVES (EACH) \$92</i>	16.5	18	43	class 125 cwt 150 lb cu ft 16	724	783
	HW1418L-43 - _ - _	hinged door cabinet with two adjustable shelves hinge on left <i>SOLID WOOD SHELVES (EACH) \$28</i> <i>ADDITIONAL SHELVES (EACH) \$92</i>	16.5	18	43	class 125 cwt 150 lb cu ft 16	724	783
	4HW1472 - _ - _	hinged door cabinet with one adjustable shelf in each side <i>SOLID WOOD SHELVES (EACH) \$28</i> <i>ADDITIONAL SHELVES (EACH) \$92</i>	24	72	29	class 125 cwt 270 lb cu ft 43	4,053 W 3,402 P	4,378 W 3,676 P
	HW1436 - _ - _	hinged door cabinet with one adjustable shelf <i>SOLID WOOD SHELVES (EACH) \$28</i> <i>ADDITIONAL SHELVES (EACH) \$92</i>	24	36	29	class 125 cwt 125 lb cu ft 21	2,020 W 1,646 P	2,181 W 1,778 P
	HW1472HW - _ - _	storage cabinet hinged doors upper and lower with two adjustable shelves upper and one adjustable shelf lower standard black pulls <i>SOLID WOOD SHELVES (EACH) \$28</i> <i>ADDITIONAL SHELVES (EACH) \$92</i>	24	36	70.75	class 125 cwt 270 lb cu ft 43	4,980	5,377
	HW14722F - _ - _	storage cabinet hinged doors upper with two adjustable shelves two lateral files below standard black pulls <i>SOLID WOOD SHELVES (EACH) \$28</i> <i>ADDITIONAL SHELVES (EACH) \$92</i>	24	36	70.75	class 125 cwt 270 lb cu ft 43	5,199	5,615
	HO1436-43 - _ - _	open bookcase hutch two adjustable shelves <i>SOLID WOOD SHELVES (EACH) \$28</i> <i>ADDITIONAL SHELVES (EACH) \$92</i>	16.5	36	43	class 125 cwt 100 lb cu ft 21	1,549	1,763
	HO1418-43 - _ - _	open bookcase hutch two adjustable shelves <i>SOLID WOOD SHELVES (EACH) \$28</i> <i>ADDITIONAL SHELVES (EACH) \$92</i>	16.5	18	43	class 125 cwt 60 lb cu ft 10	669	721

top

**P** laminate top  
**W** wood top

**pulls** routed out (curved) finger pull standard

edge







veer

1400 series

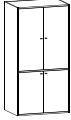
laminated top, veneer chassis, veneer drawer fronts  
 veneer top, veneer chassis, veneer drawer fronts

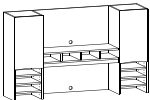
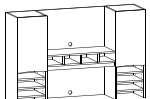
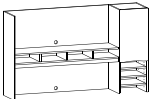
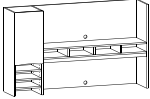

	model number	description	d	w	h	freight	list \$ zone 1	zone 2
	AV1472HW - _ - _	tv cabinet upper, pocket doors, pull-out swivel tv tray hinged door cabinet below with one adjustable shelf standard black pulls <i>SOLID WOOD SHELVES (EACH) \$28</i> <i>ADDITIONAL SHELVES (EACH) \$92</i>	24	36	70.75	class 125 cwt 290 lb cu ft 43	5,754	6,217
	AV14722F - _ - _	tv cabinet upper, pocket doors, pull-out swivel tv tray lateral file below standard black pulls	24	36	70.75	class 125 cwt 320 lb cu ft 43	5,957	6,422
	WD1472 - _ - _	wardrobe	24	36	72	class 125 cwt 320 lb cu ft 42	3,602	3,890
	WD1472R-18 - _ - _	18" wardrobe hinged right	24	18	72	class 125 cwt 170 lb cu ft 23	2,597	2,805
	WD1472L-18 - _ - _	18" wardrobe hinged left	24	18	72	class 125 cwt 170 lb cu ft 23	2,597	2,805
	TO1472 - _ - _	tower overhead with cabinets on sides open in center 1 shelf behind doors paper management slots <i>SOLID WOOD SHELVES (EACH) \$28</i> <i>ADDITIONAL SHELVES (EACH) \$92</i> <i>CHROME DETAIL STRIP ON BACK PANEL AND SHELF EDGES SPECIFY AND ADD (LIST) \$419</i>	16.5	72	43	class 125 cwt 260 lb cu ft 40	2,912	3,146
	TO1466 - _ - _	tower overhead with cabinets on sides open in center 1 shelf behind doors paper management slots <i>SOLID WOOD SHELVES (EACH) \$28</i> <i>ADDITIONAL SHELVES (EACH) \$92</i> <i>CHROME DETAIL STRIP ON BACK PANEL AND SHELF EDGES SPECIFY AND ADD (LIST) \$419</i>	16.5	66	43	class 125 cwt 247 lb cu ft 38	2,763	2,985
	TOR1472 - _ - _	tower overhead cabinet on right 1 shelf behind door paper management slots <i>SOLID WOOD SHELVES (EACH) \$28</i> <i>ADDITIONAL SHELVES (EACH) \$92</i> <i>CHROME DETAIL STRIP ON SHELF SUPPORTS SPECIFY AND ADD (LIST) \$154</i>	16.5	72	43	class 125 cwt 253 lb cu ft 40	2,424	2,619
	TOL1472 - _ - _	tower overhead cabinet on left 1 shelf behind door paper management slots <i>SOLID WOOD SHELVES (EACH) \$28</i> <i>ADDITIONAL SHELVES (EACH) \$92</i> <i>CHROME DETAIL STRIP ON SHELF SUPPORTS SPECIFY AND ADD (LIST) \$154</i>	16.5	72	43	class 125 cwt 253 lb cu ft 40	2,424	2,619

**laminated**

- 6LC-P light cherry on cherry laminate
- 7MC-P medium cherry on cherry laminate
- 8DC-P dark cherry on cherry laminate



**veener**  
tops only

- 6LC-W light cherry on cherry veneer
- 7MC-W medium cherry on cherry veneer
- 8DC-W dark cherry on cherry veneer

veer  
1400

## F1472FP-6LC-P

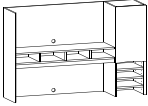
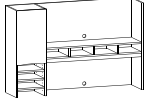
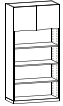
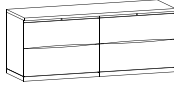
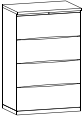
unit identification (type), top dimension, chassis option - chassis & top finish - top material

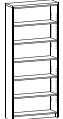
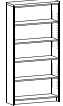
	model number	description	d	w	h	freight	list \$ zone 1	list \$ zone 2
	<b>TOR1466</b> - _ - _	tower overhead cabinet on right 1 shelf behind door paper management slots SOLID WOOD SHELVES (EACH) <b>\$28</b> ADDITIONAL SHELVES (EACH) <b>\$92</b> CHROME DETAIL STRIP ON SHELF SUPPORTS SPECIFY AND ADD (LIST) <b>\$154</b>	16.5	66	43	class 125 cwt 240 lb cu ft 38	<b>2,276</b>	<b>2,458</b>
	<b>TOL1466</b> - _ - _	tower overhead cabinet on left 1 shelf behind door paper management slots SOLID WOOD SHELVES (EACH) <b>\$28</b> ADDITIONAL SHELVES (EACH) <b>\$92</b> CHROME DETAIL STRIP ON SHELF SUPPORTS SPECIFY AND ADD (LIST) <b>\$154</b>	16.5	66	43	class 125 cwt 240 lb cu ft 38	<b>2,276</b>	<b>2,458</b>
	<b>BCW1472</b> - _ - _	bookcase with doors on top 3 adjustable shelves SOLID WOOD SHELVES (EACH) <b>\$28</b> ADDITIONAL SHELVES (EACH) <b>\$92</b>	16.5	36	72	class 125 cwt 280 lb cu ft 37	<b>1,884 W</b>	<b>2,035 W</b>
	<b>4FD1472</b> - _ - _	four drawer lateral file two drawers side by side all four drawers have letter and legal capacity anti-tip locking mechanism	24	72	29	class 125 cwt 265 lb cu ft 29	<b>4,307 W</b> <b>3,657 P</b>	<b>4,652 W</b> <b>3,949 P</b>
	<b>4FD1436</b> - _ - _	four drawer lateral file all four drawers have letter and legal capacity anti-tip locking mechanism	24	36	54.75	class 125 cwt 265 lb cu ft 29	<b>3,210 W</b> <b>2,837 P</b>	<b>3,467 W</b> <b>3,064 P</b>
	<b>3FD1436</b> - _ - _	three drawer lateral file all three drawers have letter and legal capacity anti-tip locking mechanism	24	36	41	class 125 cwt 255 lb cu ft 25	<b>2,897 W</b> <b>2,523 P</b>	<b>3,128 W</b> <b>2,725 P</b>
	<b>2FD1436</b> - _ - _	two drawer lateral file both drawers have letter and legal capacity anti-tip locking mechanism	24	36	29	class 125 cwt 175 lb cu ft 16	<b>2,147 W</b> <b>1,774 P</b>	<b>2,318 W</b> <b>1,916 P</b>
	<b>BC1484</b> - _ - _	84" bookcase four adjustable shelves one fixed shelf in center SOLID WOOD SHELVES (EACH) <b>\$28</b> ADDITIONAL SHELVES (EACH) <b>\$92</b>	12	36	84	class 125 cwt 145 lb cu ft 24	<b>1,774 W</b> <b>1,508 P</b>	<b>1,910 W</b> <b>1,621 P</b>
	<b>BC1472</b> - _ - _	72" bookcase three adjustable shelves one fixed shelf in center SOLID WOOD SHELVES (EACH) <b>\$28</b> ADDITIONAL SHELVES (EACH) <b>\$92</b>	12	36	72	class 125 cwt 130 lb cu ft 24	<b>1,566 W</b> <b>1,330 P</b>	<b>1,618 W</b> <b>1,433 P</b>

**top**  
P laminate top  
W wood top

**pulls** routed out (curved) finger pull standard

**edge**









veer

1400 series

laminated top, veneer chassis, veneer drawer fronts  
 veneer top, veneer chassis, veneer drawer fronts

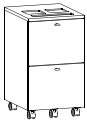

	model number	description	d	w	h	freight	list \$ zone 1	zone 2
	BC1460 - _ - _	60" bookcase two adjustable shelves one fixed shelf in center SOLID WOOD SHELVES (EACH) \$28 ADDITIONAL SHELVES (EACH) \$92	12	36	60	class 125 cwt 115 lb cu ft 20	1,426 W  1,213 P	1,536 W  1,305 P
	BC1448 - _ - _	48" bookcase one adjustable shelf one fixed shelf in center SOLID WOOD SHELVES (EACH) \$28 ADDITIONAL SHELVES (EACH) \$92	12	36	48	class 125 cwt 96 lb cu ft 16	1,234 W  1,050 P	1,330 W  1,129 P
	BC1436 - _ - _	36" bookcase two adjustable shelves SOLID WOOD SHELVES (EACH) \$28 ADDITIONAL SHELVES (EACH) \$92	12	36	36	class 125 cwt 85 lb cu ft 12	1,078 W  916 P	1,161 W  986 P
	BC1430 - _ - _	30" bookcase one adjustable shelf SOLID WOOD SHELVES (EACH) \$28 ADDITIONAL SHELVES (EACH) \$92	12	36	30	class 125 cwt 80 lb cu ft 11	1,010 W  858 P	1,087 W  924 P
	MP142F - _ - _	mobile pedestal file/file drawers with locking casters for use under any 29" surface black tray top standard black pulls	18.9	15.6	27.25	class 125 cwt 75 lb cu ft 6	1,217	1,315
	MP143D - _ - _	mobile pedestal box/box/file drawers with locking casters for use under any 29" surface black tray top standard black pulls	18.9	15.6	27.25	class 125 cwt 75 lb cu ft 6	1,232	1,331

veer  
1400

**laminated**

- 6LC-P light cherry on cherry laminated
- 7MC-P medium cherry on cherry laminated
- 8DC-P dark cherry on cherry laminated

**veener**  
tops only

- 6LC-W light cherry on cherry veneer
- 7MC-W medium cherry on cherry veneer
- 8DC-W dark cherry on cherry veneer

# inwood

OFFICE  
ENVIRONMENTS

## price list

effective 01 january 2012

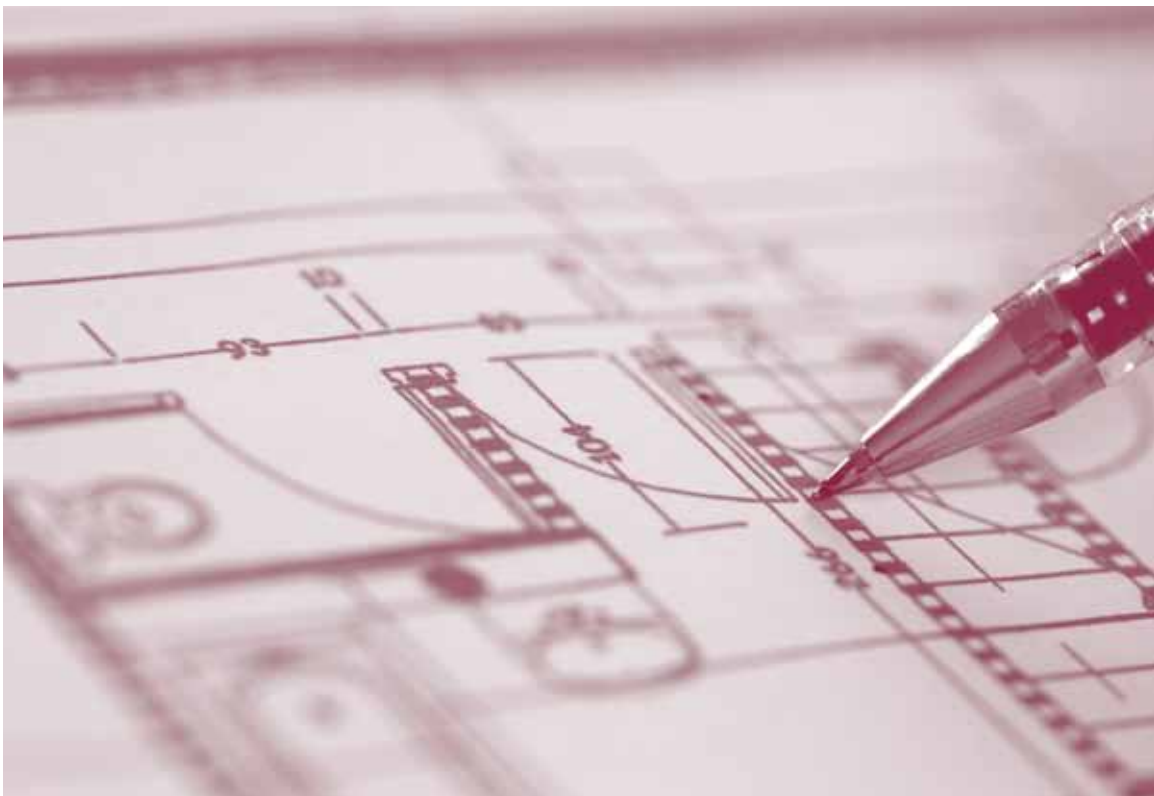

account # \_\_\_\_\_  
discount \_\_\_\_\_  
zone \_\_\_\_\_  
c.s.r. \_\_\_\_\_  
sales rep. \_\_\_\_\_

ebb  
1100

[click here for warranty  
and terms information](#)

zones one and two



# inwood

OFFICE  
ENVIRONMENTS

---



ebb  
1100

## ebb 1100 series specifications

### materials:

All wood is thoroughly air and kiln dried to a moisture content not to exceed 8% at the time of assembly.

### veneers:

All exposed surfaces are plain sliced Cherry. Veneers are carefully slip-matched and balanced. All drawer fronts, doors, end panels, and modesty panels are vertical grain.

### top work surfaces:

Laminate tops 1.25" thick, 3-ply construction, consisting of a high pressure laminate work surface and a 45 lb. density flake board core and a Gator-Ply backing.

### modesty panels:

Recessed 3/4" thick, 3-ply construction with a vertical veneer on exposed surfaces and a 45 lb density particle board core.

### construction:

Mortise and tenon and glue are used to join pedestal sides and back. All joints are reinforced with glue blocks. All pedestals have box drawers and file drawers with the option of black or satin nickel clamshell drawer pulls. Each pedestal has a lock and is keyed alike. All the bookcase shelves are standard 3/4" thick.

### drawers:

Drawer fronts are 3/4" thick, 3-ply construction with vertical book matched veneer. Drawer edges are veneered on top and sides with matching wood veneer. Box drawers have a high grade Sterling metal ball-bearing drawer suspension. File drawers have a high grade Sterling metal ball bearing full telescoping suspension and are equipped with metal rods for hanging file folders. All drawers have smooth quiet operation.

*NOTE: Optional center drawers available.*

### inside drawer dimensions:

box drawers: 4" H x 12 1/8" W x 15 9/16" L  
4" H x 12 1/8" W x 22 1/8" L  
file drawers: 9 1/2" H x 12 1/8" W x 15 9/16" L  
9 1/2" H x 12 1/8" W x 25 3/8" L  
lateral files: 9 1/2" H x 32 5/8" W x 16" L

### locking:

Each pedestal has its own lock and is keyed alike on each unit. Each unit is equipped with two keys. Units may be keyed alike in groups (per office, if requested) for an additional charge of \$36 list per unit.

### finish:

All Inwood finishes are a catalyzed varnish finish. Our multi-step satin finishes leave an open grain natural look to the furniture. Available in the following finishes: (6LC) light cherry on cherry, (7MC) medium cherry on cherry, (8DC) dark cherry on cherry and laminate tops only.

### pulls/grommets:

Standard silver (satin nickel) pull used. Optional black available (no upcharge) specify OB. When silver (satin nickel) pull used a silver grommet will be used. When optional black pull used optional black grommet will be used.



**ebb**

letter  
front to back

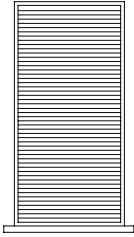

letter  
side to side

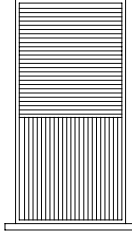

letter/legal  
combination

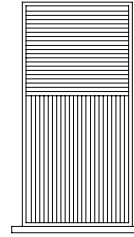

**returns  
and  
credenzas**

letter  
front to back

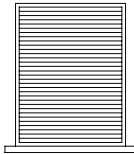

letter  
side to side

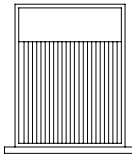

letter  
front to back

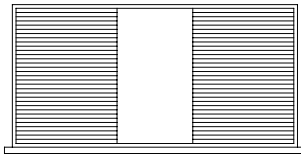

legal  
front to back

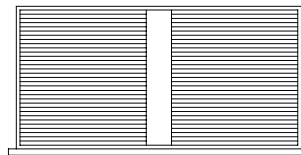

letter  
side to side

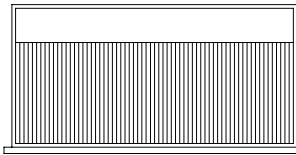

legal  
side to side

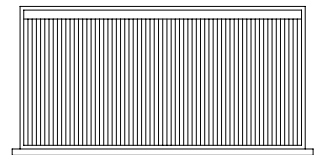



## F1172FP-8DC-P

unit identification (type), top dimension, chassis option - **chassis & top finish - top material - pull option**

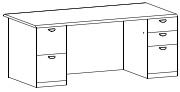
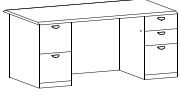
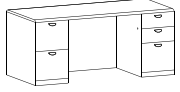
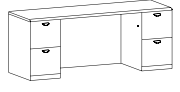
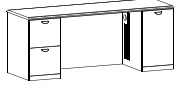
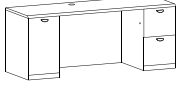
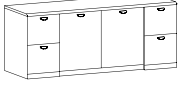
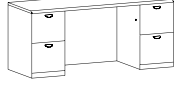
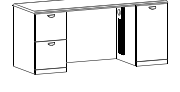
	model number	description	d w h	freight	list \$ zone 1	list \$ zone 2
[ QS ] 	<b>F1172FP</b> - - - Quick Ship available in 8DC dark cherry finish	double pedestal desk left file/file, right box/box/file file drawers have letter and legal capacity	36 72 29 <i>APPROACH: 6.25"</i> <i>KNEESPACE: 41"</i>	class 125 cwt 330 lb cu ft 53	<b>2,713 P</b>	<b>2,931 P</b>
	<b>F1166FP</b> - - -	double pedestal desk left file/file, right box/box/file file drawers have letter and legal capacity	36 66 29 <i>APPROACH: 6.25"</i> <i>KNEESPACE: 35"</i>	class 125 cwt 300 lb cu ft 48	<b>2,706 P</b>	<b>2,922 P</b>
	<b>F116630FP</b> - - -	double pedestal desk left file/file, right box/box/file file drawers have letter and legal capacity	30 66 29 <i>KNEESPACE: 35"</i>	class 125 cwt 285 lb cu ft 40	<b>2,647 P</b>	<b>2,859 P</b>
[ QS ] 	<b>CR117224FP</b> - - - Quick Ship available in 8DC dark cherry finish	kneespace credenza right and left file/file pedestals file drawers have letter and legal capacity	24 72 29 <i>KNEESPACE: 41"</i>	class 125 cwt 285 lb cu ft 34	<b>2,416 P</b>	<b>2,609 P</b>
	<b>CR117224RCFP</b> - - -	kneespace credenza left file/file pedestal right cpu storage	24 72 29 <i>KNEESPACE: 41"</i>	class 125 cwt 285 lb cu ft 34	<b>2,052 P</b>	<b>2,222 P</b>
	<b>CR117224LCFP</b> - - -	kneespace credenza right file/file pedestal left cpu storage	24 72 29 <i>KNEESPACE: 41"</i>	class 125 cwt 285 lb cu ft 34	<b>2,052 P</b>	<b>2,222 P</b>
	<b>CR117224DFP</b> - - -	storage credenza file drawers have letter and legal capacity (side filing) hinged doors enclose storage area with one adjustable shelf <i>SOLID WOOD SHELVES (EACH) \$28</i> <i>ADDITIONAL SHELVES (EACH) \$92</i>	24 72 29	class 125 cwt 315 lb cu ft 34	<b>2,801 P</b>	<b>3,023 P</b>
	<b>CR116624FP</b> - - -	kneespace credenza right and left file/file pedestals file drawers have letter and legal capacity	24 66 29 <i>KNEESPACE: 35"</i>	class 125 cwt 285 lb cu ft 34	<b>2,199 P</b>	<b>2,377 P</b>
	<b>CR116624RCFP</b> - - -	kneespace credenza left file/file pedestal right cpu storage	24 66 29 <i>KNEESPACE: 35"</i>	class 125 cwt 225 lb cu ft 30	<b>1,926 P</b>	<b>2,066 P</b>

top

lamine top

to add laptop ped in any desk (min 36" deep) add 1,162 zone 1 \ \$1,255 zone 2 list upcharge

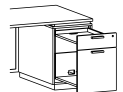

pulls

ebb standard satin nickel pulls (SP) are available in an optional black (OB) finish



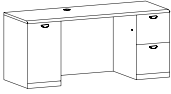
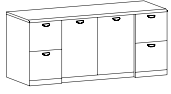
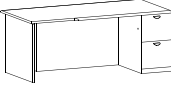
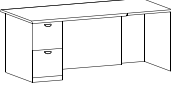
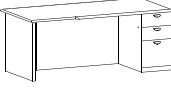
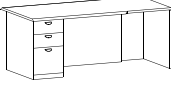
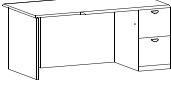
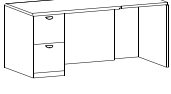
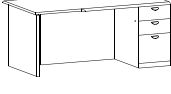

	model number	description	d w h	freight	list \$ zone 1	list \$ zone 2
	<b>CR116624LCFP</b> - - - -	kneespace credenza right file/file pedestal left cpu storage	24 66 29 <i>KNEESPACE: 35"</i>	class 125 cwt 225 lb cu ft 30	<b>1,926 P</b>	<b>2,066 P</b>
	<b>CR116624DFP</b> - - - -	storage credenza file drawers have letter and legal capacity hinged doors enclose storage area with one adjustable shelf <i>SOLID WOOD SHELVES (EACH) \$28</i> <i>ADDITIONAL SHELVES (EACH) \$92</i>	24 66 29	class 125 cwt 285 lb cu ft 30	<b>2,640 P</b>	<b>2,850 P</b>
[ QS ] 	<b>D1172R-FP</b> - - - Quick Ship available in 8DC dark cherry finish	single pedestal desk right file/file pedestal	36 72 29 <i>APPROACH: 6.25"</i> <i>KNEESPACE: 32"</i>	class 125 cwt 270 lb cu ft 53	<b>1,999 P</b>	<b>2,205 P</b>
[ QS ] 	<b>D1172L-FP</b> - - - Quick Ship available in 8DC dark cherry finish	single pedestal desk left file/file pedestal	36 72 29 <i>APPROACH: 6.25"</i> <i>KNEESPACE: 32"</i>	class 125 cwt 270 lb cu ft 53	<b>1,999 P</b>	<b>2,205 P</b>
	<b>D1172R-FP3D</b> - - - -	single pedestal desk right box/box/file pedestal	36 72 29 <i>APPROACH: 6.25"</i> <i>KNEESPACE: 32"</i>	class 125 cwt 270 lb cu ft 53	<b>1,953 P</b>	<b>2,109 P</b>
	<b>D1172L-FP3D</b> - - - -	single pedestal desk left box/box/file pedestal	36 72 29 <i>APPROACH: 6.25"</i> <i>KNEESPACE: 32"</i>	class 125 cwt 270 lb cu ft 53	<b>1,953 P</b>	<b>2,109 P</b>
	<b>D1166R-FP</b> - - - - - -	single pedestal desk right file/file pedestal	36 66 29 <i>APPROACH: 6.25"</i> <i>KNEESPACE: 26"</i>	class 125 cwt 260 lb cu ft 48	<b>1,838 P</b>	<b>1,986 P</b>
	<b>D1166L-FP</b> - - - - - -	single pedestal desk left file/file pedestal	36 66 29 <i>APPROACH: 6.25"</i> <i>KNEESPACE: 26"</i>	class 125 cwt 260 lb cu ft 48	<b>1,838 P</b>	<b>1,986 P</b>
	<b>D1166R-FP3D</b> - - - -	single pedestal desk right box/box/file pedestal	36 66 29 <i>APPROACH: 6.25"</i> <i>KNEESPACE: 26"</i>	class 125 cwt 260 lb cu ft 48	<b>1,925 P</b>	<b>2,077 P</b>

laminates  
tops only

**6LC-P** light cherry on cherry laminate  
**7MC-P** medium cherry on cherry laminate  
**8DC-P** dark cherry on cherry laminate

## F1172FP-8DC-P

unit identification (type), top dimension, chassis option - **chassis & top finish** - **top material** - **pull option**

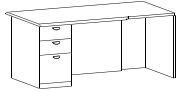
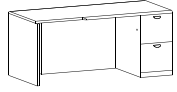
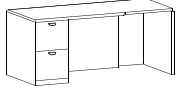
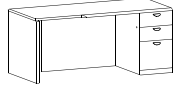
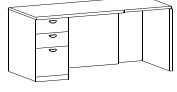
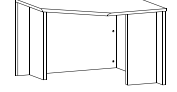
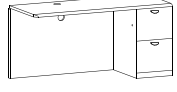
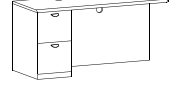
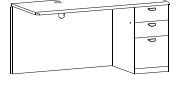
	model number	description	d w h	freight	list \$ zone 1	list \$ zone 2
	<b>D1166L-FP3D</b> - - - -	single pedestal desk left box/box/file pedestal	36 66 29  <i>APPROACH: 6.25"</i> <i>KNEESPACE: 26"</i>	class 125 cwt 260 lb cu ft 48	<b>1,925 P</b>	<b>2,077 P</b>
	<b>D116630R-FP</b> - - -	single pedestal desk right file/file pedestal	30 66 29  <i>APPROACH: 6.25"</i> <i>KNEESPACE: 26"</i>	class 125 cwt 245 lb cu ft 40	<b>1,775 P</b>	<b>1,917 P</b>
	<b>D116630L-FP</b> - - -	single pedestal desk left file/file pedestal	30 66 29  <i>KNEESPACE: 26"</i>	class 125 cwt 245 lb cu ft 40	<b>1,775 P</b>	<b>1,917 P</b>
	<b>D116630R-FP3D</b> - - - -	single pedestal desk right box/box/file pedestal	30 66 29  <i>KNEESPACE: 26"</i>	class 125 cwt 245 lb cu ft 40	<b>1,860 P</b>	<b>2,009 P</b>
	<b>D116630L-FP3D</b> - - - -	single pedestal desk left box/box/file pedestal	30 66 29  <i>KNEESPACE: 26"</i>	class 125 cwt 245 lb cu ft 40	<b>1,860 P</b>	<b>2,009 P</b>
	<b>CU1142</b> - - - -	corner unit	42 42 29  <i>KNEESPACE: 26"</i>	class 85kd cwt 175 lb cu ft 7	<b>1,589 P</b>	<b>1,718 P</b>
	<b>R1160R-FF</b> - - - -  <i>USE WITH CU1142 ONLY</i>	single pedestal return right file/file pedestal	24 60 29  <i>KNEESPACE: 43"</i>	class 125 cwt 165 lb cu ft 30	<b>1,556 P</b>	<b>1,679 P</b>
	<b>R1160L-FF</b> - - - -  <i>USE WITH CU1142 ONLY</i>	single pedestal return left file/file pedestal	24 60 29  <i>KNEESPACE: 43"</i>	class 125 cwt 165 lb cu ft 30	<b>1,556 P</b>	<b>1,679 P</b>
	<b>R1160R-3D</b> - - - -  <i>USE WITH CU1142 ONLY</i>	single pedestal return right box/box/file pedestal	24 60 29  <i>KNEESPACE: 43"</i>	class 125 cwt 165 lb cu ft 30	<b>1,641 P</b>	<b>1,772 P</b>

**top**



lamine top

**pulls**

ebb standard satin nickel pulls (SP) are available in an optional black (OB) finish



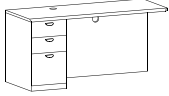
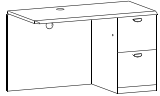
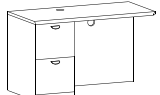
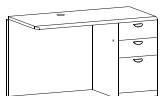
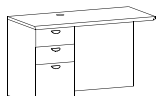
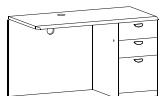

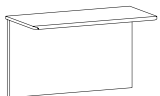
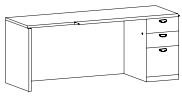
	model number	description	d w h	freight	list \$ zone 1	list \$ zone 2
	<b>R1160L-3D</b> - _ - _	single pedestal return left box/box/file pedestal  <i>USE WITH CU1142 ONLY</i>	24 60 29 <i>KNEESPACE: 43"</i>	class 125 cwt 165 lb cu ft 30	<b>1,641 P</b>	<b>1,772 P</b>
	<b>R1148R-FF</b> - _ - _	single pedestal return right file/file pedestal  <i>USE WITH CU1142 ONLY</i>	24 48 29 <i>KNEESPACE: 31"</i>	class 125 cwt 145 lb cu ft 24	<b>1,036 P</b>	<b>1,119 P</b>
	<b>R1148L-FF</b> - _ - _	single pedestal return left file/file pedestal  <i>USE WITH CU1142 ONLY</i>	24 48 29 <i>KNEESPACE: 31"</i>	class 125 cwt 145 lb cu ft 24	<b>1,036 P</b>	<b>1,119 P</b>
[ QS ] 	<b>R1148R-EHFP</b> - _ - _  Quick Ship available in 8DC dark cherry finish	single pedestal return right box/box/file pedestal  <i>USE WITH SINGLE PEDESTAL DESK</i>	24 48 29 <i>KNEESPACE: 31"</i>	class 125 cwt 145 lb cu ft 24	<b>1,334 P</b>	<b>1,395 P</b>
[ QS ] 	<b>R1148L-EHFP</b> - _ - _  Quick Ship available in 8DC dark cherry finish	single pedestal return left box/box/file pedestal  <i>USE WITH SINGLE PEDESTAL DESK</i>	24 48 29 <i>KNEESPACE: 31"</i>	class 125 cwt 145 lb cu ft 24	<b>1,334 P</b>	<b>1,395 P</b>
	<b>R1148R-3D</b> - _ - _	single pedestal return right box/box/file pedestal  <i>USE WITH CU1142 ONLY</i>	24 48 29 <i>KNEESPACE: 31"</i>	class 125 cwt 145 lb cu ft 24	<b>1,122 P</b>	<b>1,213 P</b>
	<b>R1148L-3D</b> - _ - _	single pedestal return left box/box/file pedestal  <i>USE WITH CU1142 ONLY</i>	24 48 29 <i>KNEESPACE: 31"</i>	class 125 cwt 145 lb cu ft 24	<b>1,122 P</b>	<b>1,213 P</b>
	<b>B1148-EH</b> - _ - _	bridge open kneespace	24 48 29 <i>KNEESPACE: 48"</i>	class 85 cwt 65 lb cu ft 7	<b>618 P</b>	<b>667 P</b>
	<b>C1172R-FP</b> - _ - _	single pedestal credenza right box/box/file pedestal	24 72 29 <i>KNEESPACE: 32"</i>	class 125 cwt 205 lb cu ft 34	<b>1,527 P</b>	<b>1,648 P</b>



laminates  
tops only

**6LC-P** light cherry on cherry laminate  
**7MC-P** medium cherry on cherry laminate  
**8DC-P** dark cherry on cherry laminate

ebb  
1100

## F1172FP-8DC-P

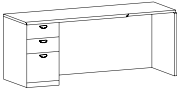
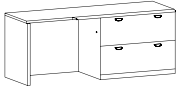
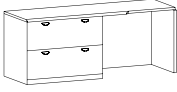
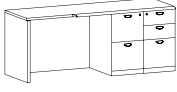
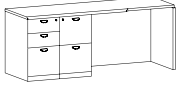
unit identification (type), top dimension, chassis option - **chassis & top finish** - **top material** - **pull option**

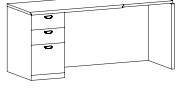
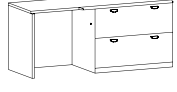
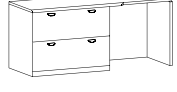
	model number	description	d w h	freight	list \$ zone 1	list \$ zone 2
	C1172L-FP - _ - _	single pedestal credenza left box/box/file pedestal	24 72 29 <i>KNEESPACE: 32"</i>	class 125 cwt 205 lb cu ft 34	1,527 P	1,648 P
	C1172R-FM2F - _ - _	single pedestal credenza right lateral file pedestal	24 72 29 <i>KNEESPACE: 12"</i>	class 125 cwt 250 lb cu ft 34	2,098 P	2,265 P
	C1172L-FM2F - _ - _	single pedestal credenza left lateral file pedestal	24 72 29	class 125 cwt 250 lb cu ft 34	2,098 P	2,265 P
	C1172R-FM5D - _ - _	single pedestal credenza right multi-file pedestal (2 box/3 file drawers)	24 72 29 <i>KNEESPACE: 12"</i>	class 125 cwt 250 lb cu ft 34	2,366 P	2,556 P
	C1172L-FM5D - _ - _	single pedestal credenza left multi-file pedestal (2 box/3 file drawers)	24 72 29 <i>KNEESPACE: 12"</i>	class 125 cwt 250 lb cu ft 34	2,366 P	2,556 P
	C1166R-FP - _ - _	single pedestal credenza right box/box/file pedestal	24 66 29 <i>KNEESPACE: 26"</i>	class 125 cwt 195 lb cu ft 30	1,499 P	1,619 P
	C1166L-FP - _ - _	single pedestal credenza left box/box/file pedestal	24 66 29 <i>KNEESPACE: 26"</i>	class 125 cwt 195 lb cu ft 30	1,499 P	1,619 P
	C1166R-FM2F - _ - _	single pedestal credenza right lateral file pedestal	24 66 29 <i>KNEESPACE: 5"</i>	class 125 cwt 240 lb cu ft 30	2,069 P	2,234 P
	C1166L-FM2F - _ - _	single pedestal credenza left lateral file pedestal	24 66 29 <i>KNEESPACE: 5"</i>	class 125 cwt 240 lb cu ft 30	2,069 P	2,234 P

top

lamine top

pulls

ebb standard satin nickel pulls (SP) are available in an optional black (OB) finish



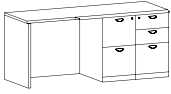
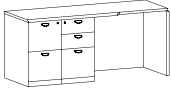
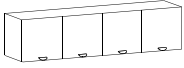
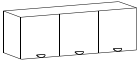
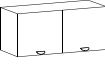
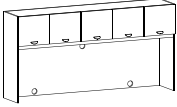
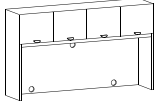
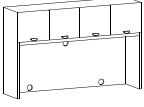
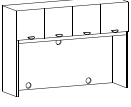

	model number	description	d w h	freight	list \$ zone 1	list \$ zone 2
	<b>C1166R-FM5D -</b> - -	single pedestal credenza right multi-file pedestal (2 box/3 file drawers)	24 66 29 <small>KNEESPACE: 11"</small>	class 125 cwt 240 lb cu ft 30	<b>2,338 P</b>	<b>2,523 P</b>
	<b>C1166L-FM5D -</b> - -	single pedestal credenza left multi-file pedestal (2 box/3 file drawers)	24 66 29 <small>KNEESPACE: 11"</small>	class 125 cwt 240 lb cu ft 30	<b>2,338 P</b>	<b>2,523 P</b>
	<b>WH1166 -</b> _	66" wide wall hung unit overhead four hinged doors	16 66 16	class 125 cwt 110 lb cu ft 13	<b>1,792</b>	<b>1,935</b>
	<b>WH1148 -</b> _	48" wide wall hung unit overhead three hinged doors	16 48 16	class 125 cwt 90 lb cu ft 10	<b>1,541</b>	<b>1,665</b>
	<b>WH1136 -</b> _	36" wide wall hung unit overhead two hinged doors	16 36 16	class 125 cwt 75 lb cu ft 7	<b>1,010</b>	<b>1,090</b>
	<b>OU1184 -</b> _	overhead storage unit five hinged doors three wire management grommets	16.5 83.75 43.25 <small>OPENING: 26.25"</small>	class 125 cwt 200 lb cu ft 40	<b>3,413</b>	<b>3,685</b>
<b>[ QS ]</b> 	<b>OU1172 -</b> _ Quick Ship available in 8DC dark cherry finish	overhead storage unit four hinged doors three wire management grommets	16.5 71.8 43.25 <small>OPENING: 26.25"</small>	class 125 cwt 200 lb cu ft 40	<b>2,661 P</b>	<b>2,864 P</b>
	<b>OU1166 -</b> _	overhead storage unit four hinged doors three wire management grommets	16.5 65.8 43.25 <small>OPENING: 26.25"</small>	class 125 cwt 185 lb cu ft 38	<b>2,571</b>	<b>2,770</b>
	<b>OU1160 -</b> _	overhead storage unit four hinged doors three wire management grommets	16.5 58.25 43.25 <small>OPENING: 26.25"</small>	class 125 cwt 170 lb cu ft 28	<b>2,174</b>	<b>2,349</b>

laminates  
tops only

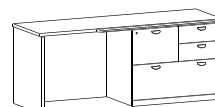

**6LC-P** light cherry on cherry laminate  
**7MC-P** medium cherry on cherry laminate  
**8DC-P** dark cherry on cherry laminate



We offer a 4D configuration option (as shown). For information please call customer service.

## F1172FP-8DC-P

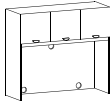
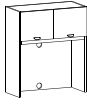
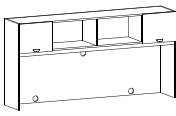
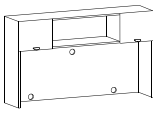
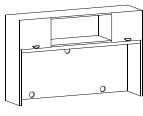
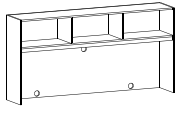
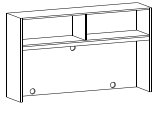
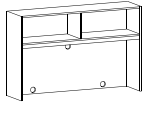
unit identification (type), top dimension, chassis option - **chassis & top finish** - **top material** - **pull option**

	model number	description	d w h	freight	list \$ zone 1	list \$ zone 2
	OU1148 - __	overhead storage unit three hinged doors three wire management grommets	16.5 46.25 43.25 <i>OPENING: 26.25"</i>	class 125 cwt 145 lb cu ft 22	<b>2,068</b>	<b>2,233</b>
	OU1136 - __	overhead storage unit three hinged doors three wire management grommets	16.5 46.25 43.25 <i>OPENING: 26.25"</i>	class 125 cwt 145 lb cu ft 22	<b>1,814</b>	<b>1,959</b>
	OD1184 - __	overhead storage unit open center and one hinged door on each end three wire management grommets	16.5 83.75 43.25 <i>OPENING: 26.25"</i>	class 125 cwt 185 lb cu ft 40	<b>3,094</b>	<b>3,341</b>
	OD1172 - __	overhead storage unit open center and one hinged door on each end three wire management grommets	16.5 71.8 43.25 <i>OPENING: 26.25"</i>	class 125 cwt 185 lb cu ft 40	<b>2,342</b>	<b>2,531</b>
	OD1166 - __	overhead storage unit open center and one hinged door on each end three wire management grommets	16.5 65.8 43.25 <i>OPENING: 26.25"</i>	class 125 cwt 170 lb cu ft 38	<b>2,230</b>	<b>2,410</b>
	OO1184 - __	open overhead storage unit three wire management grommets	16.5 83.75 43.25 <i>OPENING: 26.25"</i>	class 125 cwt 175 lb cu ft 40	<b>2,737 P</b>	<b>2,955 P</b>
	OO1172 - __	open overhead storage unit three wire management grommets	16.5 71.8 43.25 <i>OPENING: 26.25"</i>	class 125 cwt 175 lb cu ft 40	<b>1,986</b>	<b>2,142</b>
	OO1166 - __	open overhead storage unit three wire management grommets	16.5 65.8 43.25 <i>OPENING: 26.25"</i>	class 125 cwt 160 lb cu ft 38	<b>1,910</b>	<b>2,064</b>
	USU84 - __	underside paper storage for use with 84" overhead storage units does not prevent the use of task lights or tackboards  <i>FACTORY INSTALLED</i>	15.5 82 4	class cwt lb cu ft	<b>512</b>	<b>554</b>

**top**

lamine top





for **tackboard options**, see pages 522-523  
for standard fabrics available on tackboards, see page 504

**pulls**

ebb standard satin nickel pulls (SP) are available in an optional black (OB) finish



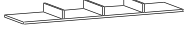

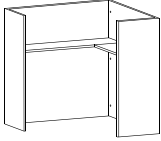
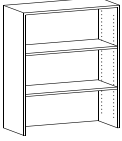
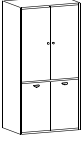
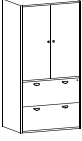
	model number	description	d	w	h	freight	list \$ zone 1	list \$ zone 2
	USU72 - _	underside paper storage for use with 72" overhead storage units does not prevent the use of task lights or tackboards  <i>FACTORY INSTALLED</i>	15.5	70	4	class cwt lb cu ft	498	536
	USU66 - _	underside paper storage for use with 66" overhead storage units does not prevent the use of task lights or tackboards  <i>FACTORY INSTALLED</i>	15.5	64	4	class cwt lb cu ft	498	536
	USU60 - _	underside paper storage for use with 60" overhead storage units does not prevent the use of task lights or tackboards  <i>FACTORY INSTALLED</i>	15.5	58	4	class cwt lb cu ft	498	536
	USU48 - _	underside paper storage for use with 48" overhead storage units does not prevent the use of task lights or tackboards  <i>FACTORY INSTALLED</i>	15.5	46	4	class cwt lb cu ft	292	315
	USU36 - _	underside paper storage for use with 36" overhead storage units does not prevent the use of task lights or tackboards  <i>FACTORY INSTALLED</i>	15.5	34	4	class cwt lb cu ft	292	315
	CUH1142 - _	corner unit hutch  <i>FOR USE WITH CU1142</i>	38	12	32	class 85kd cwt 105 lb cu ft 7	1,812	1,994
	HO1136 - _	open bookcase hutch two adjustable shelves  <i>SET UNIT ON HW1136 OR 2FD1136</i>  <i>SOLID WOOD SHELVES (EACH) \$28</i> <i>ADDITIONAL SHELVES (EACH) \$92</i>	16.5	36	42.5	class 125 cwt 105 lb cu ft 19	1,549	1,763
	HW1172HW - _	storage cabinet hinged doors upper and lower with two adjustable shelves upper and one adjustable shelf lower  <i>SOLID WOOD SHELVES (EACH) \$28</i> <i>ADDITIONAL SHELVES (EACH) \$92</i>	24	36	72	class 125 cwt 270 lb cu ft 43	4,980	5,384
	HW11722F - _	storage cabinet hinged door upper and lateral file below with two adjustable shelves in upper  <i>SOLID WOOD SHELVES (EACH) \$28</i> <i>ADDITIONAL SHELVES (EACH) \$92</i>	24	36	72	class 125 cwt 320 lb cu ft 43	5,199	5,615





laminate  
tops only

6LC-P light cherry on cherry laminate  
7MC-P medium cherry on cherry laminate  
8DC-P dark cherry on cherry laminate

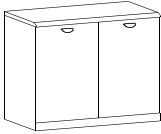
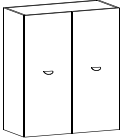
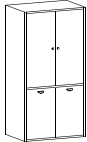
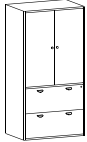
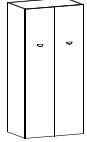

## F1172FP-8DC-P

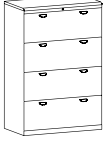
unit identification (type), top dimension, chassis option - **chassis & top finish** - **top material** - **pull option**

	model number	description	d	w	h	freight	list \$ zone 1	list \$ zone 2
	HW1136 - _ - _	hinged door cabinet with one adjustable shelf  <i>SOLID WOOD SHELVES (EACH) \$28</i> <i>ADDITIONAL SHELVES (EACH) \$92</i>	20	36	29	class 125 cwt 120 lb cu ft 16	1,557 P	1,679 P
	HW1136-42 - _	hutch with two doors  <i>SOLID WOOD SHELVES (EACH) \$28</i> <i>ADDITIONAL SHELVES (EACH) \$92</i>	17.25	36	42.5	class 125 cwt 140 lb cu ft 20	2,000 P	2,129 P
	AV1172HW - _	tv cabinet pocket doors with pull-out swivel tv tray upper hinged doors with one adjustable shelf below  <i>SOLID WOOD SHELVES (EACH) \$28</i> <i>ADDITIONAL SHELVES (EACH) \$92</i>	24	36	72	class 125 cwt 290 lb cu ft 43	5,754 P	6,217 P
	AV11722F - _	tv cabinet pocket doors with pull-out swivel tv tray upper lateral file below	24	36	72	class 125 cwt 340 lb cu ft 43	5,957	6,433
	WD1172 - _ - _	wardrobe (no top) right side coat storage left side three adjustable shelves storage shelf above one fixed shelf  <i>SOLID WOOD SHELVES (EACH) \$28</i> <i>ADDITIONAL SHELVES (EACH) \$92</i>	24	36	72	class 125 cwt 290 lb cu ft 43	3,602	3,879
	WD1172R-18 - _ WD1172L-18 - _	wardrobe (no top) (R) hinge on right/knob on left (L) hinge on left/knob on right coat storage one fixed shelf  <i>SOLID WOOD SHELVES (EACH) \$28</i> <i>ADDITIONAL SHELVES (EACH) \$92</i>	24	18	72	class 125 cwt 170 lb cu ft 23	2,597 P	2,847 P
	4FD1136 - _ - _	four drawer lateral file all four drawers have letter and legal capacity standard anti-tip locking system	20	36	54	class 125 cwt 260 lb cu ft 29	2,864 P	3,095 P
	3FD1136 - _ - _	three drawer lateral file both drawers have letter and legal capacity standard anti-tip locking system	20	36	41	class 125 cwt 170 lb cu ft 16	2,435 P	2,630 P
[ QS ] 	2FD1136 - _ - _ Quick Ship available in 8DC dark cherry finish	two drawer lateral file both drawers have letter and legal capacity standard anti-tip locking system	20	36	29	class 125 cwt 170 lb cu ft 16	1,683 P	1,816 P

top

laminate top

pulls

ebb standard satin nickel pulls (SP) are available in an optional black (OB) finish







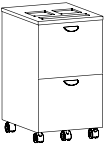
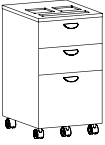
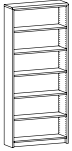

ebb

1100 series

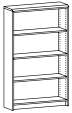
laminare top, veneer chassis, veneer drawer fronts  
 wood top, veneer chassis, veneer drawer fronts



	model number	description	d w h	freight	list \$ zone 1	list \$ zone 2
	MP112F - _	mobile pedestal file/file drawers with locking casters for use under any 29" surface black tray top	18.9 16.6 27.3	class 125 cwt 75 lb cu ft 6	1,217 P	1,315 P
	MP113D - _	mobile pedestal box/box/file drawers with locking casters for use under any 29" surface black tray top	18.9 16.6 27.3	class 125 cwt 75 lb cu ft 6	1,232 P	1,331 P
	BC1184 - _ - _	bookcase four adjustable shelves one fixed shelf in center  <i>SOLID WOOD SHELVES (EACH) \$28</i> <i>ADDITIONAL SHELVES (EACH) \$92</i>	12 36 84	class 125 cwt 155 lb cu ft 28	1,514 P	1,635 P
	BC1172 - _ - _	bookcase three adjustable shelves one fixed shelf in center  <i>SOLID WOOD SHELVES (EACH) \$28</i> <i>ADDITIONAL SHELVES (EACH) \$92</i>	12 36 72	class 125 cwt 145 lb cu ft 24	1,335 P	1,442 P
	BC1160 - _ - _	bookcase two adjustable shelves one fixed shelf in center  <i>SOLID WOOD SHELVES (EACH) \$28</i> <i>ADDITIONAL SHELVES (EACH) \$92</i>	12 36 60	class 125 cwt 115 lb cu ft 20	1,216 P	1,315 P
	BC1148 - _ - _	bookcase one adjustable shelf one fixed shelf  <i>SOLID WOOD SHELVES (EACH) \$28</i> <i>ADDITIONAL SHELVES (EACH) \$92</i>	12 36 48	class 125 cwt 96 lb cu ft 16	1,056 P	1,140 P
	BC1136 - _ - _	bookcase two adjustable shelves  <i>SOLID WOOD SHELVES (EACH) \$28</i> <i>ADDITIONAL SHELVES (EACH) \$92</i>	12 36 36	class 125 cwt 85 lb cu ft 12	922 P	996 P
	BC1130 - _ - _	bookcase one adjustable shelf  <i>SOLID WOOD SHELVES (EACH) \$28</i> <i>ADDITIONAL SHELVES (EACH) \$92</i>	12 36 30	class 125 cwt 80 lb cu ft 11	864 P	933 P





laminare  
tops only

6LC-P light cherry on cherry laminare  
 7MC-P medium cherry on cherry laminare  
 8DC-P dark cherry on cherry laminare

ebb  
1100

## F1172FP-8DC-P

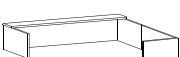
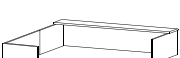
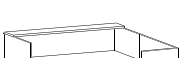
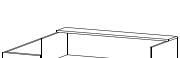
unit identification (type), top dimension, chassis option - **chassis & top finish** - **top material** - **pull option**

	model number	description	d	w	h	freight	list \$ zone 1	list \$ zone 2
	TD1172 - __	desk top transaction counter for use with 72" desk only	12	72	15.25	class 85 cwt 94 lb cu ft 8	1,118 P	1,202 P
	TD1166 - __	desk top transaction counter for use with 36" x 66" desk only	12	66	15.25	class 85 cwt 84 lb cu ft 6	1,118 P	1,202 P
	TD116630 - __	desk top transaction counter for use with 30" x 66" desk only	12	66	15.25	class 85 cwt 84 lb cu ft 6	1,118 P	1,202 P
	TM1172R - __	desk top transaction/reception gallery for use with 72" right executive "I" unit only  <i>PANEL HEIGHT 14</i>	84	72	15.25	class 85 cwt 100 lb cu ft 8	1,653 P	1,777 P
	TM1172L - __	desk top transaction/reception gallery for use with 72" left executive "I" unit only  <i>PANEL HEIGHT 14</i>	84	72	15.25	class 85 cwt 100 lb cu ft 8	1,653 P	1,777 P
	TM1166R - __	desk top transaction/reception gallery for use with 66" right executive "I" unit only  <i>PANEL HEIGHT 14</i>	84	66	15.25	class 85 cwt 94 lb cu ft 8	1,653 P	1,777 P
	TM1166L - __	desk top transaction/reception gallery for use with 66" left executive "I" unit only  <i>PANEL HEIGHT 14</i>	84	66	15.25	class 85 cwt 94 lb cu ft 8	1,653 P	1,777 P
	TM116630R - __	desk top transaction/reception gallery for use with 66" x 30" right executive "I" unit only  <i>PANEL HEIGHT 14</i>	78	66	15.25	class 85 cwt 94 lb cu ft 8	1,653 P	1,777 P
	TM116630L - __	desk top transaction/reception gallery for use with 66" x 30" left executive "I" unit only  <i>PANEL HEIGHT 14</i>	78	66	15.25	class 85 cwt 94 lb cu ft 8	1,653 P	1,777 P

top



laminate top

pulls

ebb standard satin nickel pulls (SP) are available in an optional black (OB) finish



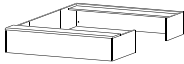
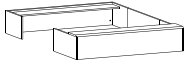
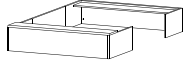
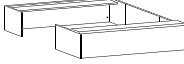
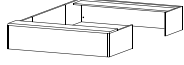

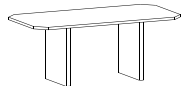
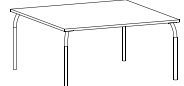
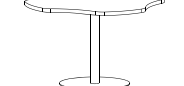
	model number	description	d	w	h	freight	list \$ zone 1	list \$ zone 2
	TU1172R - _ _	desk top transaction/reception gallery for use with 72" right executive "u" unit only  PANEL HEIGHT 14	108	72	15.25	class 85 cwt 150 lb cu ft 10	2,234 P	2,406 P
	TU1172L - _ _ - _	desk top transaction/reception gallery for use with 72" left executive "u" unit only  PANEL HEIGHT 14	108	72	15.25	class 85 cwt 150 lb cu ft 10	2,234 P	2,406 P
	TU1166R - _ _ - _	desk top transaction/reception gallery for use with 66" right executive "u" unit only  PANEL HEIGHT 14	108	66	15.25	class 85 cwt 140 lb cu ft 10	2,234 P	2,406 P
	TU1166L - _ _ - _	desk top transaction/reception gallery for use with 66" left executive "u" unit only  PANEL HEIGHT 14	108	66	15.25	class 85 cwt 140 lb cu ft 10	2,234 P	2,406 P
	TU116630R - _ _ - _	desk top transaction/reception gallery for use with 66" right executive "u" unit only  PANEL HEIGHT 14	102	66	15.25	class 85 cwt 140 lb cu ft 10	2,234 P	2,406 P
	TU116630L - _ _ - _	desk top transaction/reception gallery for use with 66" left executive "u" unit only  PANEL HEIGHT 14	102	66	15.25	class 85 cwt 140 lb cu ft 10	2,234 P	2,406 P
	OV7236 SB-22	octagonal table top veneer top/self edge  slab wood base 2 for above top	72	36		class 85 cwt 190 lb cu ft	3,014 P	3,299 P
	SW60 AL	square table top with single post leg laminate top/wood edge  single post leg 2.5" dia (black)	60	60		class 79 lb cwt cu ft	1,495 P	1,607 P
	CLS48 PDB-20	clover top with post disc base laminate top/self edge  post disc base (silver)				class 55 lb cwt cu ft	1,393 P	1,506 P

laminate tops only

6LC-P light cherry on cherry laminate  
7MC-P medium cherry on cherry laminate  
8DC-P dark cherry on cherry laminate

# inwood

OFFICE  
ENVIRONMENTS

## price list

effective 01 january 2012

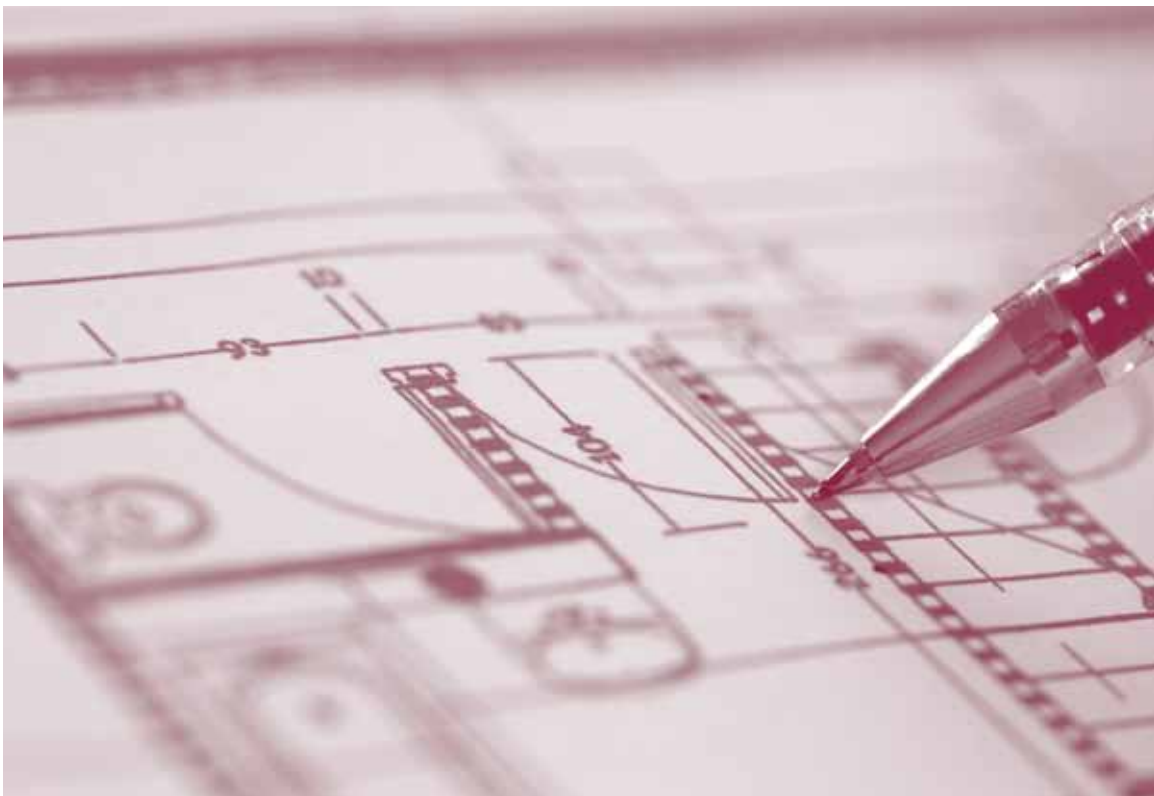

account # \_\_\_\_\_  
discount \_\_\_\_\_  
zone \_\_\_\_\_  
c.s.r. \_\_\_\_\_  
sales rep. \_\_\_\_\_

## ashton

800

[click here for warranty  
and terms information](#)

zones one and two





ashton  
800

### ashton 800 series specifications

#### materials:

All wood is thoroughly air and kiln dried to a moisture content not to exceed 8% at the time of assembly.

#### veneers:

All exposed surfaces are plain sliced American Black Walnut. Veneers are carefully book-matched and balanced. All drawer fronts, doors, end panels, and modesty panels are vertical grain.

#### top work surfaces:

Laminate tops are 1 1/4", 3-ply construction; consisting of a high-pressure laminate work surface and a 45 lb density flake board core. The under side of the top has a smooth surface Gator-Ply backing sheet. Top rims are laminate self-edge on all four sides.

#### modesty panels:

3/4" thick, 3-ply construction with a vertical Walnut book matched veneer on exposed surfaces and a 45 lb density flake board core. Available modesty panels options are full to the floor or 3/4 modesty panels.

#### construction:

Uses a mortise and tenon and glue to join panels and modesty panels. All joints are reinforced with glue blocks. All pedestals have a box drawer and file drawer, with side route finger drawer pulls. Each pedestal has a lock and is keyed alike. All bookcase shelves are standard 3/4" thick.

#### drawers:

Drawer fronts are 3/4" thick, 3-ply construction with vertical book matched Walnut or Oak veneer. Drawer edges are veneered on top and sides with matching Walnut or Oak. All drawer sides and backs are plywood, dovetailed front and back with 3-ply drawer bottoms. Drawer bottoms are framed on four sides and stapled from the bottom side. Drawer interiors are finished with a clear coat sealer to prevent swelling or shrinkage. Box drawers have a high grade Sterling metal ball-bearing drawer suspension. File drawers have a high grade Sterling metal ball bearing full progressive suspension and are equipped with metal rods for hanging file folders. All drawers have smooth quiet operation.  
*NOTE: Optional center drawers available.*

#### inside drawer dimensions:

box drawers: 4" H x 12 1/8" W x 15 9/16" L  
4" H x 12 1/8" W x 22 1/8" L  
file drawers: 9 1/2" H x 12 1/8" W x 15 9/16" L  
9 1/2" H x 12 1/8" W x 25 3/8" L  
lateral files: 9 1/2" H x 32 5/8" W x 16" L

#### locking:

Each pedestal has its own lock and is keyed alike on each unit. Each unit is equipped with two keys. Units may be keyed alike in groups (per office, if requested) for an additional charge of \$36 list per unit.

#### finish:

All Inwood finishes are catalyzed varnish and have excellent durability. Our multi-step satin finishes leave an open grain natural look to the furniture, and is available in the following finishes: (25C) cherry on walnut, (25M) mahogany on walnut, (4L) dark mahogany on walnut and (3L) saddle on walnut.

#### grommets:

Standard black grommets will be used. Optional silver available (no upcharge)



**ashton**

**desks**

letter  
front to back

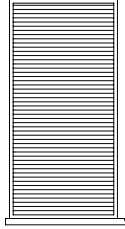

letter  
side to side

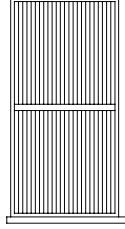

letter/legal  
combination

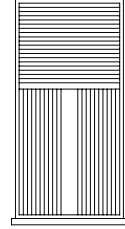

**returns  
and  
credenzas**

letter  
front to back

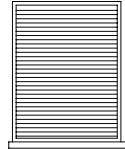

letter  
side to side

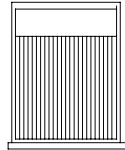

**lateral files**

letter  
front to back

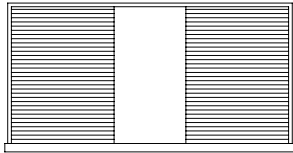

legal  
front to back

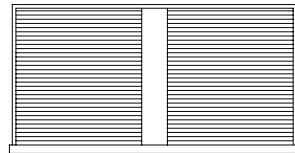

letter  
side to side

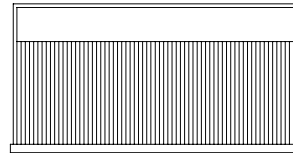

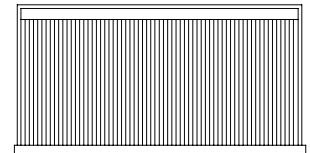

legal  
side to side



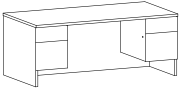
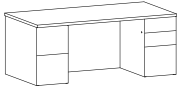
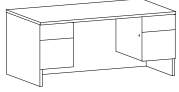

## F872-FM-25M-P

unit identification (type), top dimension - chassis option - chassis & top finish

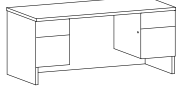
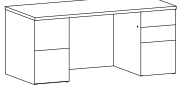
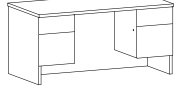
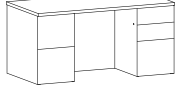
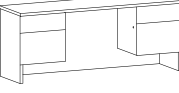
	model number	description	d w h	freight	list \$ zone 1	list \$ zone 2
	F872FM - __ - __	double pedestal desk box/file pedestals	36 72 29 <i>KNEESPACE: 40"</i>	class 125 cwt 295 lb cu ft 53	2,340	2,526
	F872FP - __ - __	double pedestal desk left file/file, right box/box/file	36 72 29 <i>KNEESPACE: 40"</i>	class 125 cwt 415 lb cu ft 53	3,121	3,374
	F866FM - __ - __	double pedestal desk box/file pedestals	36 66 29 <i>KNEESPACE: 34"</i>	class 125 cwt 300 lb cu ft 48	2,333	2,520
	F866FP - __ - __	double pedestal desk left file/file, right box/box/file	36 66 29 <i>KNEESPACE: 34"</i>	class 125 cwt 405 lb cu ft 48	3,112	3,362
	F86630FM - __ - __	double pedestal desk box/file pedestals	30 66 29 <i>KNEESPACE: 34"</i>	class 125 cwt 290 lb cu ft 40	2,170	2,343
	F86630FP - __ - __	double pedestal desk left file/file, right box/box/file	30 66 29 <i>KNEESPACE: 34"</i>	class 125 cwt 395 lb cu ft 40	2,753	2,972
	F860FM - __ - __	double pedestal desk box/file pedestals	30 60 29 <i>KNEESPACE: 28"</i>	class 125 cwt 245 lb cu ft 40	1,926	2,078
	F860FP - __ - __	double pedestal desk left file/file, right box/box/file	30 60 29 <i>KNEESPACE: 28"</i>	class 125 cwt 335 lb cu ft 40	2,507	2,708
	CR872FM - __ - __	credenza box/file pedestals	20 72 29 <i>KNEESPACE: 40"</i>	class 125 cwt 230 lb cu ft 28	1,813	1,957

top

P laminate top

ashton full modesty panel and 3/4 drawer pedestal (FM) or full to the floor pedestal and full modesty panel (FP).

edge

G

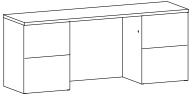
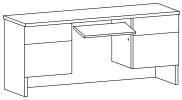
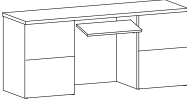
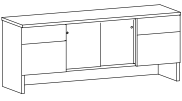
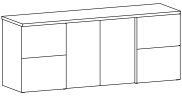
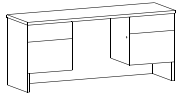
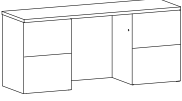
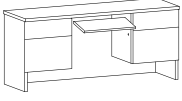
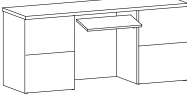

	model number	description	d w h	freight	list \$ zone 1	list \$ zone 2
	CR872FP - _ - _	credenza file/file pedestals	20 72 29 <i>KNEESPACE: 40"</i>	class 125 cwt 275 lb cu ft 28	2,433	2,627
	CR872KBFM - _ - _	credenza with keyboard box/file pedestals  <i>ARTICULATING KEYBOARD HEIGHT ADJUSTMENT FROM 26.5 - 29"</i>	20 72 29 <i>KNEESPACE: 40"</i>	class 125 cwt 225 lb cu ft 28	2,175	2,351
	CR872KBFP - _ - _	credenza with keyboard left file/file, right box/box/file  <i>ARTICULATING KEYBOARD HEIGHT ADJUSTMENT FROM 26.5 - 29"</i>	20 72 29 <i>KNEESPACE: 40"</i>	class 125 cwt 285 lb cu ft 28	2,795	3,017
	CR872DFM - _ - _	storage credenza double hinged door center with one adjustable shelf  <i>ADDITIONAL SHELVES (EACH) \$92</i> <i>SOLID WOOD SHELVES (EACH) \$28</i>	20 72 29	class 125 cwt 265 lb cu ft 28	2,259	2,438
	CR872DFP - _ - _	storage credenza double hinged door center with one adjustable shelf  <i>ADDITIONAL SHELVES (EACH) \$92</i> <i>SOLID WOOD SHELVES (EACH) \$28</i>	20 72 29	class 125 cwt 315 lb cu ft 28	3,003	3,243
	CR866FM - _ - _	credenza box/file pedestals	20 66 29 <i>KNEESPACE: 34"</i>	class 125 cwt 210 lb cu ft 26	1,623	1,783
	CR866FP - _ - _	credenza file/file pedestals	20 66 29 <i>KNEESPACE: 34"</i>	class 125 cwt 260 lb cu ft 26	2,212	2,389
	CR866KBFM - _ - _	credenza with keyboard box/file pedestals  <i>ARTICULATING KEYBOARD HEIGHT ADJUSTMENT FROM 26.5 - 29"</i>	20 66 29 <i>KNEESPACE: 34"</i>	class 125 cwt 225 lb cu ft 26	1,988	2,176
	CR866KBFP - _ - _	credenza with keyboard file/file pedestals  <i>ARTICULATING KEYBOARD HEIGHT ADJUSTMENT FROM 26.5 - 29"</i>	20 66 29 <i>KNEESPACE: 34"</i>	class 125 cwt 270 lb cu ft 26	2,577	2,783

laminate tops only  
**3L-P** saddle on walnut  
**4L-P** dark mahogany on walnut  
**25M-P** mahogany on walnut  
**25C-P** cherry on walnut

## F872-FM-25M-P

unit identification (type), top dimension - chassis option - chassis & top finish

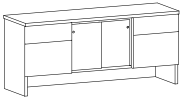
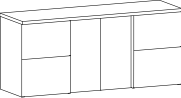
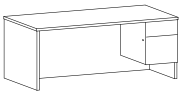
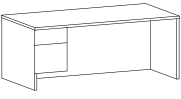
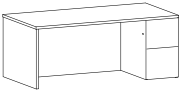
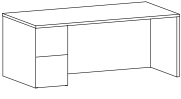
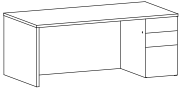
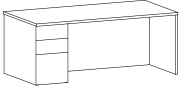
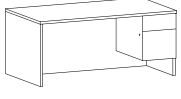
	model number	description	d	w	h	freight	list \$ zone 1	list \$ zone 2
	CR866DFM - _ - _	storage credenza double sliding door center with one adjustable shelf  <i>ADDITIONAL SHELVES (EACH) \$92</i> <i>SOLID WOOD SHELVES (EACH) \$28</i>	20	66	29	class 125 cwt 250 lb cu ft 26	2,070	2,235
	CR866DFP - _ - _	storage credenza double hinged door center with one adjustable shelf  <i>ADDITIONAL SHELVES (EACH) \$92</i> <i>SOLID WOOD SHELVES (EACH) \$28</i>	20	66	29	class 125 cwt 268 lb cu ft 26	2,783	3,005
	D872RFM - _ - _	single pedestal desk right box/file pedestal	36	72	29	class 125 cwt 270 lb cu ft 53	2,132	2,302
	D872LFM - _ - _	single pedestal desk left box/file pedestal	36	72	29	class 125 cwt 270 lb cu ft 53	2,132	2,302
	D872RFP - _ - _	single pedestal desk right file/file pedestal	36	72	29	class 125 cwt 290 lb cu ft 53	2,590	2,793
	D872LFP - _ - _	single pedestal desk left file/file pedestal	36	72	29	class 125 cwt 290 lb cu ft 53	2,590	2,793
	D872RFP3D - _ - _	single pedestal desk right box/box/file pedestal	36	72	29	class 125 cwt 290 lb cu ft 53	2,852	3,079
	D872LFP3D - _ - _	single pedestal desk left box/box/file pedestal	36	72	29	class 125 cwt 290 lb cu ft 53	2,852	3,079
	D866RFM - _ - _	single pedestal desk right box/file pedestal	36	66	29	class 125 cwt 260 lb cu ft 48	2,110	2,280

top

P laminate top

ashton full modesty panel and 3/4 drawer pedestal (FM) or full to the floor pedestal and full modesty panel (FP).

edge

G

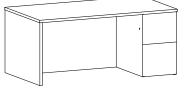
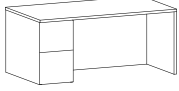
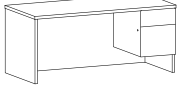
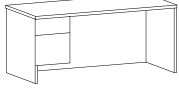
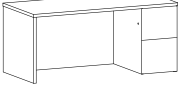
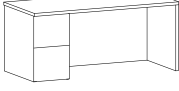
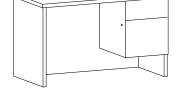
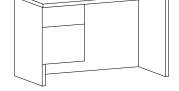

	model number	description	d	w	h	freight	list \$	zone 1	list \$	zone 2
	D866LFM - _ - _	single pedestal desk left box/file pedestal	36	66	29	class 125 cwt 260 lb cu ft 48	2,110		2,280	
	D866RFP - _ - _	single pedestal desk right file/file pedestal	36	66	29	class 125 cwt 280 lb cu ft 48	2,565		2,772	
	D866LFP - _ - _	single pedestal desk left file/file pedestal	36	66	29	class 125 cwt 280 lb cu ft 48	2,565		2,772	
	D86630RFM - _ - _	single pedestal desk right box/file pedestal	30	66	29	class 125 cwt 245 lb cu ft 40	1,744		1,884	
	D86630LFM - _ - _	single pedestal desk left box/file pedestal	30	66	29	class 125 cwt 245 lb cu ft 40	1,744		1,884	
	D86630RFP - _ - _	single pedestal desk right file/file pedestal	30	66	29	class 125 cwt 265 lb cu ft 40	2,198		2,376	
	D86630LFP - _ - _	single pedestal desk left file/file pedestal	30	66	29	class 125 cwt 265 lb cu ft 40	2,198		2,376	
	D848RFM - _ - _	single pedestal desk right box/file pedestal grommet in top for wire management	24	48	29	class 125 cwt 150 lb cu ft 24	1,340		1,446	
	D848LFM - _ - _	single pedestal desk left box/file pedestal grommet in top for wire management	24	48	29	class 125 cwt 150 lb cu ft 24 <small>KNEESPACE: 30"</small>	1,340		1,446	

laminates  
tops only

- 3L-P saddle on walnut
- 4L-P dark mahogany on walnut
- 25M-P mahogany on walnut
- 25C-P cherry on walnut

## F872-FM-25M-P

unit identification (type), top dimension - chassis option - chassis & top finish

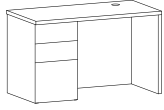
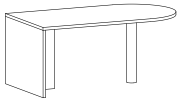
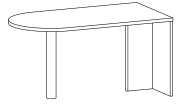
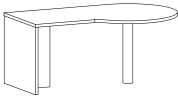
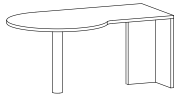
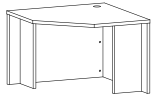
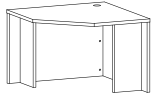
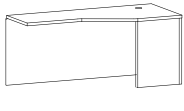
	model number	description	d	w	h	freight	list \$ zone 1	list \$ zone 2
	D848RFP - _ - _	single pedestal desk right box/box/file pedestal grommet in top for wire management	24	48	29	class 125 cwt 225 lb cu ft 24 <small>KNEESPACE: 30"</small>	1,782	1,927
	D848LFP - _ - _	single pedestal desk left box/box/file pedestal grommet in top for wire management	24	48	29	class 125 cwt 225 lb cu ft 24 <small>KNEESPACE: 30"</small>	1,782	1,927
	BT866R - _ - _	bullet top desk - right	36	66	29	class 125 cwt 140 lb cu ft 8	1,682	1,815
	BT866L - _ - _	bullet top desk - left	36	66	29	class 125 cwt 140 lb cu ft 8	1,682	1,815
	PT866R - _ - _	"p" top desk - right	40	66	29	class 125 cwt 165 lb cu ft 8	1,707	1,845
	PT866L - _ - _	"p" top desk - left	40	66	29	class 125 cwt 165 lb cu ft 8	1,707	1,845
	CU842 - _ - _	angled corner	42	42	29	class 125 cwt 168 lb cu ft 7	1,863	2,011
	CU838 - _ - _	angled corner	38	38	29	class 125 cwt 150 lb cu ft 7	1,686	1,822
	RA866REH - _ - _	right angled return kneespace open	30	66	29	class 125 cwt 140 lb cu ft 8	1,960	2,119

top

P laminate top

ashton full modesty panel and 3/4 drawer pedestal (FM) or full to the floor pedestal and full modesty panel (FP).  
\$232 list upcharge for (TH) Typing Height return

edge

G

returns custom length return sizes are available up to 65" with the grain direction running lengthwise (opposite the desk grain), add \$493 list and specify length.



	model number	description	d	w	h	freight	list \$ zone 1	list \$ zone 2
	RA866LEH - _ - _	left angled return kneespace open	30	66	29	class 125 cwt 140 lb cu ft 8	1,960	2,119
	R824RFM - _ - _	right return right box/file pedestal  <i>FOR USE WITH CU842</i>	24	48	29	class 125 cwt 140 lb cu ft 25	1,310	1,414
	R824LFM - _ - _	left return left box/file pedestal  <i>FOR USE WITH CU842</i>	24	48	29	class 125 cwt 140 lb cu ft 25	1,310	1,414
	R824R2D - _ - _	right return right file/file pedestal  <i>FOR USE WITH CU842</i>	24	48	29	class 125 cwt 140 lb cu ft 25	1,491	1,610
	R824L2D - _ - _	left return left file/file pedestal  <i>FOR USE WITH CU842</i>	24	48	29	class 125 cwt 140 lb cu ft 25	1,491	1,610
	R824R3D - _ - _	right return right box/box/file pedestal  <i>FOR USE WITH CU842</i>	24	48	29	class 125 cwt 140 lb cu ft 25	1,653	1,785
	R824L3D - _ - _	left return left box/box/file pedestal  <i>FOR USE WITH CU842</i>	24	48	29	class 125 cwt 140 lb cu ft 25	1,653	1,785
	R820RFM - _ - _	right return right box/file pedestal  <i>FOR USE WITH CU838</i>	20	48	29	class 125 cwt 120 lb cu ft 21	1,229	1,326
	R820LFM - _ - _	left return left box/file pedestal  <i>FOR USE WITH CU838</i>	20	48	29	class 125 cwt 120 lb cu ft 21	1,229	1,326

laminates  
tops only

3L-P saddle on walnut  
4L-P dark mahogany on walnut  
25M-P mahogany on walnut  
25C-P cherry on walnut

## F872-FM-25M-P

unit identification (type), top dimension - chassis option - chassis & top finish

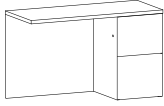
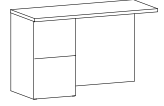
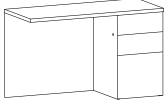
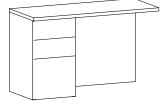
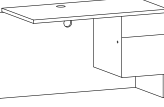
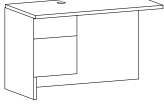
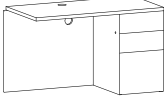
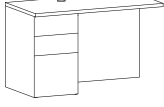
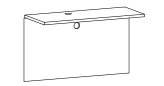
	model number	description	d	w	h	freight	list \$ zone 1	list \$ zone 2
	R820R2D - _ - _	right return right file/file pedestal  <i>FOR USE WITH CU838</i>	20	48	29	class 125 cwt 120 lb cu ft 21	1,411	1,524
	R820L2D - _ - _	left return left file/file pedestal  <i>FOR USE WITH CU838</i>	20	48	29	class 125 cwt 120 lb cu ft 21	1,411	1,524
	R820R3D - _ - _	right return right box/box/file pedestal  <i>FOR USE WITH CU838</i>	20	48	29	class 125 cwt 120 lb cu ft 21	1,572	1,699
	R820L3D - _ - _	left return left box/box/file pedestal  <i>FOR USE WITH CU838</i>	20	48	29	class 125 cwt 120 lb cu ft 21	1,572	1,699
	R848REHFM - _ - _	right return right box/file pedestal  <i>FOR USE WITH SINGLE PEDESTAL DESKS</i>	24	48	29	class 125 cwt 145 lb cu ft 25 <i>KNEESPACE: 32"</i>	1,464	1,582
	R848LEHFM - _ - _	left return left box/file pedestal  <i>FOR USE WITH SINGLE PEDESTAL DESKS</i>	24	48	29	class 125 cwt 145 lb cu ft 25	1,464	1,582
	R848REHFP - _ - _	right return right box/box/file pedestal  <i>FOR USE WITH SINGLE PEDESTAL DESKS</i>	24	48	29	class 125 cwt 165 lb cu ft 25	1,808	1,953
	R848LEHFP - _ - _	left return left box/box/file pedestal  <i>FOR USE WITH SINGLE PEDESTAL DESKS</i>	24	48	29	class 125 cwt 165 lb cu ft 25	1,808	1,953
	B848EH - _ - _	bridge kneespace open  <i>DO NOT USE WITH CORNER UNITS</i>	20	48	29	class 125 cwt 65 lb cu ft 3	539	581

top

P laminate top

**ashton** full modesty panel and 3/4 drawer pedestal (FM) or full to the floor pedestal and full modesty panel (FP).  
\$232 list upcharge for (TH) Typing Height return

edge

G

**returns** custom length return sizes are available up to 65" with the grain direction running lengthwise (opposite the desk grain), add \$493 list and specify length.

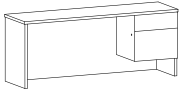
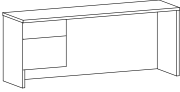
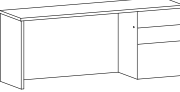
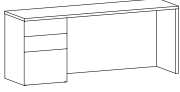
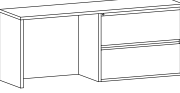
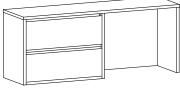
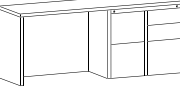
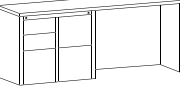
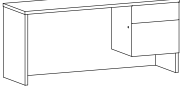

	model number	description	d	w	h	freight	list \$ zone 1	list \$ zone 2
	C872RFM - _ - _	single pedestal credenza right box/file pedestal	20	72	29	class 125 cwt 215 lb cu ft 28	1,619	1,748
	C872LFM - _ - _	single pedestal credenza left box/file pedestal	20	72	29	class 125 cwt 215 lb cu ft 28	1,619	1,748
	C872RFP - _ - _	single pedestal credenza right box/box file pedestal	20	72	29	class 125 cwt 225 lb cu ft 28	1,964	2,122
	C872LFP - _ - _	single pedestal credenza left box/box/file pedestal	20	72	29	class 125 cwt 225 lb cu ft 28	1,964	2,122
	C872RFM2F - _ - _	single pedestal credenza right lateral file pedestal	20	72	29	class 125 cwt 295 lb cu ft 28	2,370	2,563
	C872LFM2F - _ - _	single pedestal credenza left lateral file pedestal	20	72	29	class 125 cwt 295 lb cu ft 28	2,370	2,563
	C872RFM5D - _ - _	single pedestal credenza right multi-file pedestal	20	72	29	class 125 cwt 295 lb cu ft 28	2,430	2,588
	C872LFM5D - _ - _	single pedestal credenza left multi-file pedestal	20	72	29	class 125 cwt 295 lb cu ft 28	2,430	2,588
	C866RFM - _ - _	single pedestal credenza right box/file pedestal	20	66	29	class 125 cwt 205 lb cu ft 26	1,597	1,725

laminated tops only

- 3L-P saddle on walnut
- 4L-P dark mahogany on walnut
- 25M-P mahogany on walnut
- 25C-P cherry on walnut

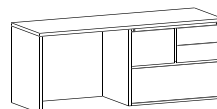

We offer a 4D configuration option (as shown). For information please call customer service.



## F872-FM-25M-P

unit identification (type), top dimension - chassis option - chassis & top finish

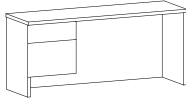
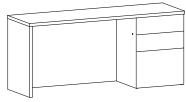
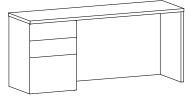
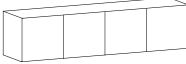
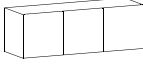
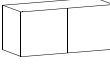
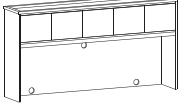
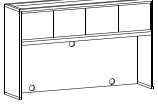
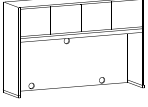
	model number	description	d	w	h	freight	list \$ zone 1	list \$ zone 2
	C866LFM - __ - __	single pedestal credenza left box/file pedestal	20	66	29	class 125 cwt 205 lb cu ft 26	1,597	1,725
	C866RFP - __ - __	single pedestal credenza right box/box/file pedestal	20	66	29	class 125 cwt 215 lb cu ft 26	1,944	2,099
	C866LFP - __ - __	single pedestal credenza left box/box/file pedestal	20	66	29	class 125 cwt 215 lb cu ft 26	1,944	2,099
	WH66 - __	66" wide wall hung unit overhead four hinged doors	16	66	16	class 125 cwt 110 lb cu ft 13	1,792	1,935
	WH48 - __	48" wide wall hung unit overhead three hinged doors	16	48	16	class 125 cwt 90 lb cu ft 10	1,541	1,665
	WH36 - __	36" wide wall hung unit overhead two hinged doors	16	36	16	class 125 cwt 75 lb cu ft 7	1,010	1,090
	OU884 - __	overhead storage unit five touch-latch hinged doors three wire management grommets	16.5	82.5	43.25	class 125 cwt 190 lb cu ft 38 <i>OPENING: 25.6"</i>	3,413	3,685
	OU872 - __	overhead storage unit four touch-latch hinged doors three wire management grommets	16.5	71	43.25	class 125 cwt 190 lb cu ft 38 <i>OPENING: 25.6"</i>	2,661	2,864
	OU866 - __	overhead storage unit four touch-latch hinged doors three wire management grommets	16.5	65	43.25	class 125 cwt 180 lb cu ft 38 <i>OPENING: 25.6"</i>	2,571	2,770

top





P laminate top

ashton full modesty panel and 3/4 drawer pedestal (FM) or full to the floor pedestal and full modesty panel (FP).  
for **tackboard options**, see pages 522-523  
for standard fabrics available on tackboards, see pages 504

edge

G

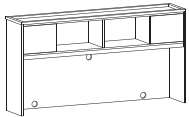
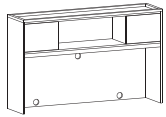
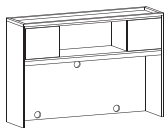
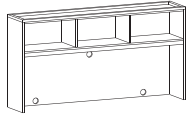
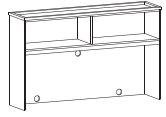
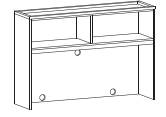









	model number	description	d	w	h	freight	list \$ zone 1	list \$ zone 2
	OU848 - _	overhead storage unit four touch-latch hinged doors three wire management grommets	16.5	47	43.25	class 125 cwt 190 lb cu ft 38  OPENING: 25.6"	2,068	2,233
	OU836 - _	overhead storage unit four touch-latch hinged doors two three wire management grommets	16.5	35	43.25	class 125 cwt 180 lb cu ft 38  OPENING: 25.6"	1,814	1,959
	OD884 - _	overhead storage unit with open center and one touch-latch door on each end three wire management grommets	16.5	82.5	43.25	class 125 cwt 185 lb cu ft 40  OPENING: 25.6"	3,094	3,341
	OD872 - _	overhead storage unit with open center and one touch-latch door on each end three wire management grommets	16.5	71	43.25	class 125 cwt 185 lb cu ft 40  OPENING: 25.6"	2,402	2,531
	OD866 - _	overhead storage unit with open center and one touch-latch door on each end three wire management grommets	16.5	65	43.5	class 125 cwt 175 lb cu ft 38  OPENING: 25.6"	2,230	2,410
	OO884 - _	open overhead storage unit three wire management grommets	16.5	82.75	43.5	class 125 cwt 180 lb cu ft 40  OPENING: 25.6"	2,737	2,955
	OO872 - _	open overhead storage unit three wire management grommets	16.5	71	43.5	class 125 cwt 180 lb cu ft 40  OPENING: 25.6"	1,986	2,142
	OO866 - _	open overhead storage unit three wire management grommets	16.5	65	43.5	class 125 cwt 170 lb cu ft 38  OPENING: 25.6"	1,910	2,064
	USU84 - _	underside paper storage for use with 84" overhead storage units does not prevent the use of task lights or tackboards  <i>FACTORY INSTALLED</i>	15.5	82	4	class cwt cu ft  <i>INSIDE DIMENSIONS:</i>	512	554

laminates only  
 3L-P saddle on walnut  
 4L-P dark mahogany on walnut  
 25M-P mahogany on walnut  
 25C-P cherry on walnut

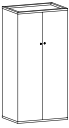
## F872-FM-25M-P

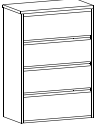
unit identification (type), top dimension - chassis option - chassis & top finish

	model number	description	d	w	h	freight	list \$ zone 1	list \$ zone 2
	USU72 - __	underside paper storage for use with 72" storage overhead units does not prevent the use of task lights or tackboards  <i>FACTORY INSTALLED</i>	15.5	70	4	class cwt cu ft	498	536
	USU66 - __	underside paper storage for use with 66" storage overhead units does not prevent the use of task lights or tackboards  <i>FACTORY INSTALLED</i>	15.5	64	4	class cwt cu ft	498	536
	USU48 - __	underside paper storage for use with 48" storage overhead units does not prevent the use of task lights or tackboards  <i>FACTORY INSTALLED</i>	15.5	46	4	class cwt cu ft	292	315
	USU36 - __	underside paper storage for use with 36" storage overhead units does not prevent the use of task lights or tackboards  <i>FACTORY INSTALLED</i>	15.5	34	4	class cwt cu ft	292	315
	WD872 - __	wardrobe two hinged doors, right side coat storage left side three adjustable shelves storage shelf above one fixed shelf <i>ADDITIONAL SHELVES (EACH) \$92</i> <i>SOLID WOOD SHELVES (EACH) \$28</i>	24	36	72	class 125 cwt 275 lb cu ft 42	3,728	4,027
	WD872R-18 - __ WD872L-18 - __	wardrobe/coat storage (R) hinge on right/knob on left (L) hinge on left/knob on right one fixed shelf  <i>ADDITIONAL SHELVES (EACH) \$92</i> <i>SOLID WOOD SHELVES (EACH) \$28</i>	24	18	72	class 125 cwt 170 lb cu ft 23	2,682	2,938
	4FD837 - __ - __	lateral file with four drawers drawers have letter and legal capacity standard anti-tip locking system	20	36	54.75	class 125 cwt 265 lb cu ft 29	2,975	3,215
	3FD837 - __ - __	lateral file with three drawers drawers have letter and legal capacity standard anti-tip locking system	20	36	46	class 125 cwt 240 lb cu ft 25	2,490	2,682
	2FD837 - __ - __	lateral file with two drawers drawers have letter and legal capacity standard anti-tip locking system	20	36	29	class 125 cwt 160 lb cu ft 16	1,751	1,930

top



P laminate top

ashton full modesty panel and 3/4 drawer pedestal (FM) or full to the floor pedestal and full modesty panel (FP).

edge

G

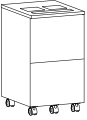
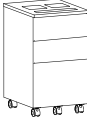
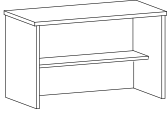
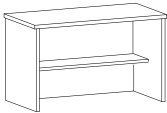
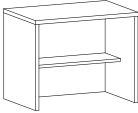
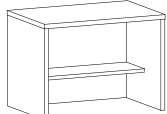

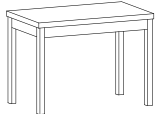
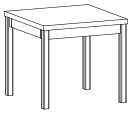



	model number	description	d	w	h	freight	list \$ zone 1	list \$ zone 2
	MP82F - __	mobile pedestal file/file drawers with locking casters for use under any 29" surface black tray top	18.9	16.6	27.3	class 125 cwt 75 lb cu ft 6	1,217	1,315
	MP83D - __	mobile pedestal box/box/file drawers with locking casters for use under any 29" surface black tray top	18.9	16.6	27.3	class 125 cwt 75 lb cu ft 6	1,232	1,331
	CRP848FM - __ - __	computer printer stand one fixed shelf  <small>LOCKING DUAL WHEEL CASTERS FOR UNIT HEIGHT OF 26.25", LIST AND SPECIFY. \$182 LOCKING DUAL WHEEL CASTERS FOR UNIT HEIGHT OF 28.25" \$115</small>	24	48	26.25	class 150 cwt 145 lb cu ft 22 <small>KNEESPACE: 45"</small>	1,588	1,717
	CRP848FM-29 - __ - __	computer printer stand one fixed shelf	24	48	29	class 150 cwt 145 lb cu ft 22 <small>KNEESPACE: 45"</small>	1,588	1,717
	CRP836FM - __ - __	computer printer stand one fixed shelf  <small>LOCKING DUAL WHEEL CASTERS FOR UNIT HEIGHT OF 26.25", LIST AND SPECIFY. \$182 LOCKING DUAL WHEEL CASTERS FOR UNIT HEIGHT OF 28.25" \$115</small>	24	36	26.25	class 150 cwt 115 lb cu ft 17 <small>KNEESPACE: 33"</small>	1,118	1,208
	CRP836FM-29 - __ - __	computer printer stand one fixed shelf	24	36	29	class 150 cwt 115 lb cu ft 17 <small>KNEESPACE: 33"</small>	1,118	1,208
	LT848 - __ - __	coffee table can ship ups	18	48	15	class 150 cwt 65 lb cu ft 6	846	914
	LT830 - __ - __	lamp table can ship ups	18	30	22	class 150 cwt 60 lb cu ft 3	580	642
	LT824 - __ - __	lamp table can ship ups	24	24	22	class 150 cwt 60 lb cu ft 3	468	508

laminates only  
 3L-P saddle on walnut  
 4L-P dark mahogany on walnut  
 25M-P mahogany on walnut  
 25C-P cherry on walnut

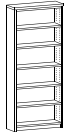
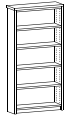
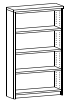
## F872-FM-25M-P

unit identification (type), top dimension - chassis option - chassis & top finish

	model number	description	d	w	h	freight	list \$ zone 1	list \$ zone 2
	BC884 - _ - _ - _	bookcase four adjustable shelves one fixed shelf in center  <i>ADDITIONAL SHELVES (EACH) \$92</i> <i>SOLID WOOD SHELVES (EACH) \$28</i>	12	36	84	class 125 cwt 145 lb cu ft 24	1,508	1,621
	BC872 - _ - _ - _	bookcase three adjustable shelves one fixed shelf in center  <i>ADDITIONAL SHELVES (EACH) \$92</i> <i>SOLID WOOD SHELVES (EACH) \$28</i>	12	36	72	class 125 cwt 130 lb cu ft 24	1,330	1,433
	BC860 - _ - _ - _	bookcase two adjustable shelves one fixed shelf in center  <i>ADDITIONAL SHELVES (EACH) \$92</i> <i>SOLID WOOD SHELVES (EACH) \$28</i>	12	36	60	class 125 cwt 115 lb cu ft 20	1,213	1,305
	BC848 - _ - _ - _	bookcase one adjustable shelf one fixed shelf  <i>ADDITIONAL SHELVES (EACH) \$92</i> <i>SOLID WOOD SHELVES (EACH) \$28</i>	12	36	48	class 125 cwt 96 lb cu ft 16	1,050	1,129
	BC836 - _ - _ - _	bookcase two adjustable shelves  <i>ADDITIONAL SHELVES (EACH) \$92</i> <i>SOLID WOOD SHELVES (EACH) \$28</i>	12	36	36	class 125 cwt 85 lb cu ft 12	916	986
	BC830 - _ - _ - _	bookcase one adjustable shelf  <i>ADDITIONAL SHELVES (EACH) \$92</i> <i>SOLID WOOD SHELVES (EACH) \$28</i>	12	36	30	class 125 cwt 80 lb cu ft 11	858	924

top

P laminate top

ashton full modesty panel and 3/4 drawer pedestal (FM) or full to the floor pedestal and full modesty panel (FP).

edge

G









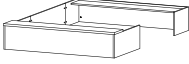

	model number	description	d	w	h	freight	list \$ zone 1	list \$ zone 2
	TD872 - _ - _	desk top transaction counter for use with 72" desk only	12	72	15.25	class 85 cwt 90 lb cu ft 6	1,118	1,202
	TD866 - _ - _	desk top transaction counter for use with 66" desk only	12	66	15.25	class 85 cwt 84 lb cu ft 6	1,118	1,202
	TD86630 - _ - _	desk top transaction counter for use with 30" x 66" desk only	12	66	15.25	class 85 cwt 84 lb cu ft 6	1,118	1,202
	TM872R - _ - _	desk top transaction/reception gallery for use with executive height 72" "I" unit  GALLERY PANELS 84" x 72" x 14"	12	72	15.25	class 85 cwt 100 lb cu ft 6	1,653	1,777
	TM872L - _ - _	desk top transaction/reception gallery for use with executive height 72" "I" unit  GALLERY PANELS 82" x 72" x 14"	12	72	15.25	class 85 cwt 100 lb cu ft 6	1,653	1,777
	TM866R - _ - _	desk top transaction/reception gallery for use with executive height 66" "I" unit  GALLERY PANELS 84" x 66" x 14"	12	66	15.25	class 85 cwt 94 lb cu ft 6	1,653	1,777
	TM866L - _ - _	desk top transaction/reception gallery for use with executive height 66" "I" unit  GALLERY PANELS 84" x 66" x 14"	12	66	15.25	class 85 cwt 94 lb cu ft 6	1,653	1,777
	TM86630L - _ - _	desk top transaction/reception gallery for use with 30" x 66" "I" unit  GALLERY PANELS 78" x 66" x 14"	12	66	15.25	class 85 cwt 94 lb cu ft 6	1,653	1,777
	TM86630R - _ - _	desk top transaction/reception gallery for use with 30" x 66" "I" unit  GALLERY PANELS 78" x 66" x 14"	12	66	15.25	class 85 cwt 94 lb cu ft 6	1,653	1,777

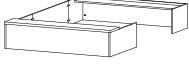
laminates only  
 3L-P saddle on walnut  
 4L-P dark mahogany on walnut  
 25M-P mahogany on walnut  
 25C-P cherry on walnut

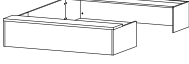
## F872-FM-25M-P

unit identification (type), top dimension - chassis option - chassis & top finish

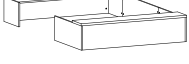
	model number	description	d	w	h	freight	list \$ zone 1	list \$ zone 2
	TU872R - _ - _	desk top transaction/reception gallery for use with 72" right "u" unit  <i>GALLERY PANELS 104" x 72" x 14"</i>	12	72	15.25	class 85 cwt 150 lb cu ft 8	2,234	2,406
	TU872L - _ - _	desk top transaction/reception gallery for use with 72" left "u" unit  <i>GALLERY PANELS 104" x 72" x 14"</i>	12	72	15.25	class 85 cwt 150 lb cu ft 8	2,234	2,406
	TU866R - _ - _	desk top transaction/reception gallery for use with 66" right "u" unit  <i>GALLERY PANELS 104" x 66" x 14"</i>	12	66	15.25	class 85 cwt 145 lb cu ft 8	2,234	2,406
	TU866L - _ - _	desk top transaction/reception gallery for use with 66" left "u" unit  <i>GALLERY PANELS 104" x 66" x 14"</i>	12	66	15.25	class 85 cwt 145 lb cu ft 8	2,234	2,406
	TU86630R - _ - _	desk top transaction/reception gallery for use with 30" x 66" "u" unit  <i>GALLERY PANELS 98" x 66" x 14"</i>	12	66	15.25	class 85 cwt 145 lb cu ft 8	2,234	2,406
	TU86630L - _ - _	desk top transaction/reception gallery for use with 30" x 66" "u" unit  <i>GALLERY PANELS 98" x 66" x 14"</i>	12	66	15.25	class 85 cwt 145 lb cu ft 8	2,234	2,406
	TU872L - _ - _	desk top transaction/reception gallery for use with 72" left "u" unit  <i>GALLERY PANELS 104" x 72" x 14"</i>	12	72	15.25	class 85 cwt 150 lb cu ft 8	2,234	2,406
	TU866R - _ - _	desk top transaction/reception gallery for use with 66" right "u" unit  gallery panels 104" x 66" x 14"	12	66	15.25	class 85 cwt 145 lb cu ft 8	2,234	2,406
	TU866L - _ - _	desk top transaction/reception gallery for use with 66" left "u" unit  gallery panels 104" x 66" x 14"	12	66	15.25	class 85 cwt 145 lb cu ft 8	2,234	2,406

top

P laminate top

ashton full modesty panel and 3/4 drawer pedestal (FM) or full to the floor pedestal and full modesty panel (FP).

edge

G

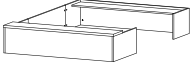
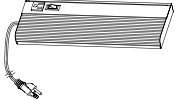
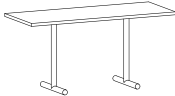
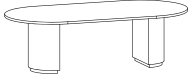
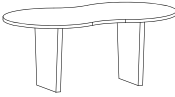

	model number	description	d	w	h	freight	list \$ zone 1	list \$ zone 2
	<b>TU86630R</b> - _ - _	desk top transaction/reception gallery for use with 30" x 66" "u" unit  gallery panels 98" x 66" x 14"	12	66	15.25	class 85 cwt 145 lb cu ft 8	<b>2,234</b>	<b>2,406</b>
	<b>TL24</b>	task light for use with overhead storage units  <i>FIELD INSTALLED ONLY</i>	7	24	2	class 100 cwt 11 lb cu ft 1	<b>335</b>	<b>364</b>
	<b>RP6024</b> <b>CC-20</b>	rectangular top with T style base laminated top/pvc edge  T-style base (2" dia.) steel (black) 2 ea for above top	60	24		class 70 cwt 81 lb cu ft	<b>1,072</b>	<b>1,142</b>  as shown
	<b>RTS9648</b> <b>1/2R-24</b>	racetrack table top with drum base laminated top/self edge  half round drum base (24"w) 2 ea for above top	96	48		class 70 cwt 225 lb cu ft	<b>2,868</b>	<b>3,097</b>  as shown
	<b>PP7240</b> <b>TB-22</b>	peanut top with tapered wood base laminated top/pvc edge  tapered wood base (22"w) 2 ea for above top	72	40		class 70 cwt 140 lb cu ft	<b>2,274</b>	<b>2,459</b>  as shown

laminated tops only  
**3L-P** saddle on walnut  
**4L-P** dark mahogany on walnut  
**25M-P** mahogany on walnut  
**25C-P** cherry on walnut



# inwood

OFFICE  
ENVIRONMENTS

## price list

effective 01 january 2012

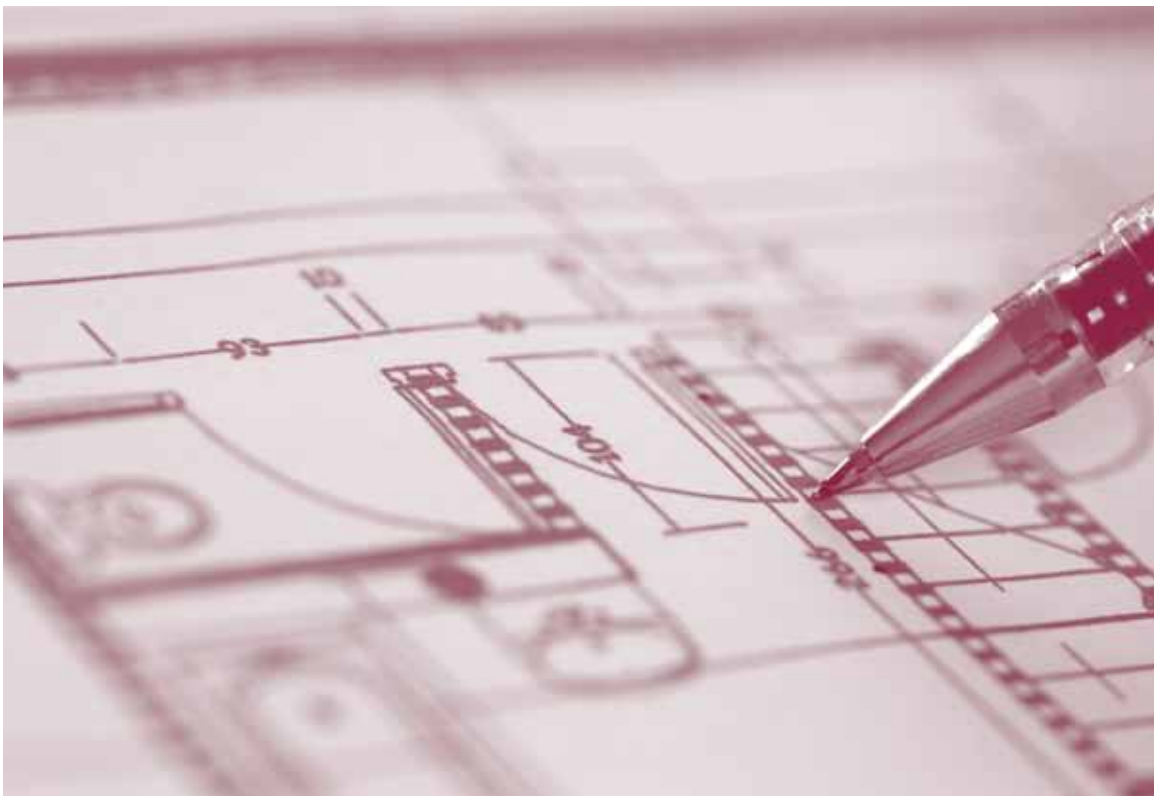

account # \_\_\_\_\_  
discount \_\_\_\_\_  
zone \_\_\_\_\_  
c.s.r. \_\_\_\_\_  
sales rep. \_\_\_\_\_

oxford  
1300

[click here for warranty  
and terms information](#)

zones one and two



# inwood

OFFICE  
ENVIRONMENTS

---



oxford  
1300

### oxford 1300 series specifications

#### materials:

All wood is thoroughly air and kiln dried to a moisture content not to exceed 8% at the time of assembly.

#### veneers:

All exposed surfaces are plain sliced Cherry. Veneers are carefully slip-matched and balanced. All drawer fronts, doors, end panels, and modesty panels are vertical grain genuine cherry.

#### top work surfaces:

- **veneer tops** are 1 1/4" thick, 5-ply construction, consisting of 1/40" thick cherry veneer work surfaces and poplar veneer backing. The top core material is a 45 lb density particleboard, with a traditional shaped solid wood rim on all four sides.
- **laminated tops** are 1 1/4", 3-ply construction; consisting of a high-pressure laminate work surface and a 45 lb density particle board core. The under side of the top has a smooth surface Gator-Ply backing sheet. Top rims are solid wood with a traditional edge shape.

#### pedestal construction:

3/4" thick 3-ply panel with 1 1/16" hardwood posts with decorative chamfered edges. Cherry veneer on all exposed surfaces and a 45 lb density flake board core. Outside panels and approach side desk panels have 3/4" raised cherry veneer decorative panels. Each pedestal in desk units has a 3-ply dictation arm slide mounted above the drawers. In the desk and credenza units each pedestal has one box drawer over one file drawer. The base is constructed and shaped in veneer wrapped MDF; adjustable leveling glides are mounted in each corner of the base. All joints are reinforced with concealed wood glue blocks. All bookcase shelves are standard 3/4" thick.

#### drawers:

Drawer fronts are 3/4" thick, 3-ply construction with vertical book matched cherry veneer. Drawer edges are veneered on top with matching cherry. All drawer sides and backs are plywood, dovetailed front and back with 3-ply drawer bottoms. Drawer bottoms are framed on four sides and stapled from the bottom side. Drawer interiors are finished with clear sealer to prevent swelling or shrinkage. Box drawers have a high grade Sterling metal ball-bearing drawer suspension. File drawers have a high grade Sterling metal ball bearing full progressive suspension and are equipped with metal rods for hanging file folders. All drawers have smooth quiet operation. Pedestals have one box drawer and one file drawer each. Drawer hardware is an Antique Brass English bail pull. Each desk is standard with a center drawer with a high grade Sterling suspension and a solid wood pen and pencil tray.

#### inside drawer dimensions:

box drawers: 4" H x 12 1/8" W x 15 9/16" L  
4" H x 12 1/8" W x 22 1/8" L  
file drawers: 9 1/2" H x 12 1/8" W x 15 9/16" L  
9 1/2" H x 12 1/8" W x 25 3/8" L  
lateral files: 9 1/2" H x 25 1/4" W x 15 9/16" L

#### locking:

Kneespace pedestal lock also locks the center drawer. Each unit is equipped with two keys. Units may be keyed alike in groups (per office, if requested) for an additional charge of \$37 list per unit.

#### finish:

All Inwood finishes are catalyzed varnish and have excellent durability. Our multi-step satin finishes leave an open grain natural look to the furniture, and are available in the following finishes: (6LC) light cherry on cherry, (7MC) medium cherry on cherry, (8DC) dark cherry on cherry, (9BC) burgundy cherry on cherry (veneer top only, no matching HPL), (1NC) natural cherry on cherry (veneer top only, no matching HPL), and (2HC) honey cherry on cherry (veneer top only, no matching HPL).

#### grommets:

Standard black grommet will be used. Optional silver available (no upcharge)



**oxford**

**desks**

letter  
front to back

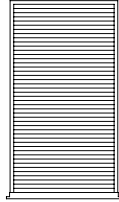

letter  
side to side

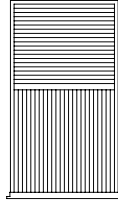

letter/legal  
combination

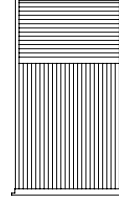

**returns  
and  
credenzas**

letter  
front to back

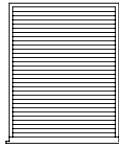

letter  
side to side

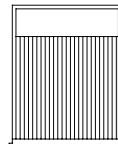

**lateral files**

letter  
side to side

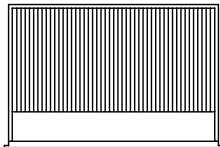



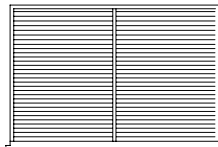

letter  
front to back

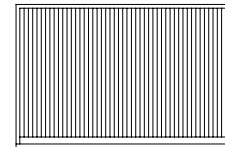

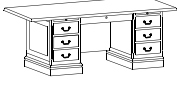
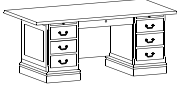
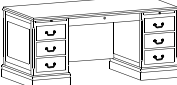
legal  
side to side

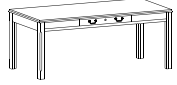
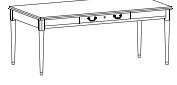
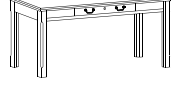
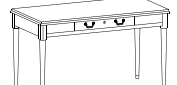

	model number	description	d w h	freight	list \$ zone 1	list \$ zone 2
	<b>CF1376</b> - _ - _	conference desk double pedestal desk center drawer arm slide, box/file drawer in both pedestals	42 76 29  <i>APPROACH: 12"</i> <i>KNEESPACE: 28"</i>	class 125 cwt 335 lb cu ft 63	<b>4,958 W</b>  <b>4,342 P</b>	<b>5,355 W</b>  <b>4,689 P</b>
[ QS ] 	<b>CF1372</b> - _ - _  Quick Ship available in 8DC dark cherry with veneer top or laminate top	conference desk double pedestal desk center drawer, arm slide box/file drawer in both pedestals	36 72 29  <i>APPROACH: 6"</i> <i>KNEESPACE: 28"</i>	class 125 cwt 305 lb cu ft 53	<b>4,834 W</b>  <b>4,281 P</b>	<b>5,219 W</b>  <b>4,624 P</b>
	<b>F136630</b> - _ - _	double pedestal desk center drawer, arm slide box/file drawer in both pedestals	30 66 29  <i>KNEESPACE: 32.5"</i>	class 125 cwt 270 lb cu ft 37	<b>4,762 W</b>  <b>4,205 P</b>	<b>5,144 W</b>  <b>4,542 P</b>
	<b>F1360</b> - _ - _	double pedestal desk center drawer, arm slide box/file drawer in both pedestals	30 60 29  <i>KNEESPACE: 26.5"</i>	class 125 cwt 285 lb cu ft 40	<b>4,578 W</b>  <b>4,030 P</b>	<b>4,942 W</b>  <b>4,348 P</b>
	<b>T1372</b> - _ - _	table desk locking cloth lined center drawer square legs	36 72 29  <i>KNEESPACE: 66"</i>	class 125 cwt 135 lb cu ft 14	<b>3,029 W</b>  <b>2,477 P</b>	<b>3,271 W</b>  <b>2,678 P</b>
	<b>T1372TL</b> - _ - _	table desk locking cloth lined center drawer turned legs	36 72 29  <i>KNEESPACE: 66"</i>	class 125 cwt 135 lb cu ft 14	<b>2,977 W</b>  <b>2,428 P</b>	<b>3,216 W</b>  <b>2,620 P</b>
	<b>T1360</b> - _ - _	table desk locking cloth lined center drawer square legs	30 60 29  <i>KNEESPACE: 54"</i>	class 125 cwt 110 lb cu ft 9	<b>2,364 W</b>  <b>1,815 P</b>	<b>2,554 W</b>  <b>1,960 P</b>
	<b>T1360TL</b> - _ - _	table desk locking cloth lined center drawer turned legs	30 60 29  <i>KNEESPACE: 54"</i>	class 125 cwt 110 lb cu ft 9	<b>2,226 W</b>  <b>1,678 P</b>	<b>2,406 W</b>  <b>1,811 P</b>
	<b>CR137224</b> - _ - _	computer depth credenza left and right box/file pedestals	24 72 29  <i>KNEESPACE: 38"</i>	class 125 cwt 220 lb cu ft 34	<b>3,486 W</b>  <b>2,990 P</b>	<b>3,766 W</b>  <b>3,230 P</b>

top

**P** laminate top  
**W** veneer top

edge



oxford

1300 series

wood top, veneer chassis, veneer drawer fronts  
laminated top, veneer chassis, veneer drawer fronts



	model number		d w h	freight	list \$ zone 1	list \$ zone 2
	CR1372 - _ - _	kneespace credenza left and right box/file pedestals	20 72 29  KNEESPACE: 38"	class 125 cwt 215 lb cu ft 28	3,266 W  2,839 P	3,527 W  3,066 P
[ QS ] 	CR1372D - _ - _  Quick Ship available in 8DC dark cherry with laminate top only	storage credenza left and right box/file pedestals sliding doors in center area with one adjustable shelf  ADDITIONAL SHELVES (EACH) \$92	20 72 29	class 125 cwt 260 lb cu ft 28	4,669 W  4,241 P	5,046 W  4,580 P
	CR137224D - _ - _	storage credenza left and right box/file pedestals sliding doors in center area with one adjustable shelf  ADDITIONAL SHELVES (EACH) \$92	24 72 29	class 125 cwt 260 lb cu ft 28	4,889 W  4,392 P	5,281 W  4,743 P
[ QS ] 	CR1372KB - _ - _  Quick Ship available in 8DC dark cherry with veneer top or laminate top	kneespace credenza with keyboard left and right box/file pedestals  ARTICULATING KEYBOARD HEIGHT ADJUSTMENT FROM 26.5 - 29"	20 72 29  KNEESPACE: 38"	class 125 cwt 225 lb cu ft 28	3,630 W  3,201 P	3,920 W  3,458 P
	CR136624 - _ - _	computer depth credenza left and right box/file pedestals  KNEESPACE: 32"	24 66 29	class 125 cwt 220 lb cu ft 30	3,439 W  2,958 P	3,715 W  3,191 P
	CR1366 - _ - _	kneespace credenza left and right box/file pedestals  KNEESPACE: 32"	20 66 29	class 125 cwt 195 lb cu ft 26	3,192 W  2,767 P	3,449 W  2,989 P
	CR1366D - _ - _	storage credenza left and right box/file pedestals sliding doors in center area with one adjustable shelf  ADDITIONAL SHELVES (EACH) \$92	20 66 29	class 125 cwt 245 lb cu ft 26	4,533 W  4,107 P	4,941 W  4,476 P
	CR136624D - _ - _	storage credenza left and right box/file pedestals sliding doors in center area with one adjustable shelf  ADDITIONAL SHELVES (EACH) \$92	24 66 29	class 125 cwt 245 lb cu ft 26	4,780 W  4,296 P	5,162 W  4,640 P
	CR1366KB - _ - _  ARTICULATING KEYBOARD HEIGHT ADJUSTMENT FROM 26.5 - 29"	kneespace credenza with keyboard left and right box/file pedestals  KNEESPACE: 32"	20 66 29	class 125 cwt 205 lb cu ft 26	3,557 W  3,131 P	3,841 W  3,382 P



laminated tops only

6LC-P light cherry on cherry  
7MC-P medium cherry on cherry  
8DC-P dark cherry on cherry

veneered tops only

6LC-W light cherry on cherry  
7MC-W medium cherry on cherry  
8DC-W dark cherry on cherry  
9BC-W burgundy cherry on cherry  
1NC-W natural cherry on cherry  
2HC-W honey cherry on cherry

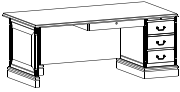
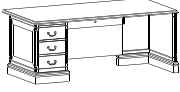
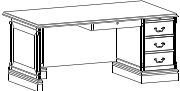
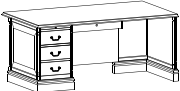
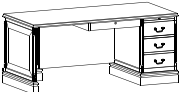
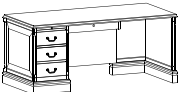
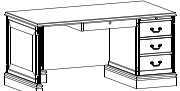
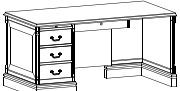
oxford  
1300

	model number	description	d w h	freight	list \$ zone 1	list \$ zone 2
[ QS ] 	<b>D1372R</b> - _ - _ <small>Quick Ship available in 8DC dark cherry with laminate top only</small>	single pedestal desk 6" overhang on approach side center drawer, arm slide left box/file pedestal	36 72 29 <small>APPROACH: 6" KNEESPACE: 31"</small>	class 125 cwt 215 lb cu ft 53	<b>4,556 W</b>  <b>4,132 P</b>	<b>4,922 W</b>  <b>4,463 P</b>
[ QS ] 	<b>D1372L</b> - _ - _ <small>Quick Ship available in 8DC dark cherry with laminate top only</small>	single pedestal desk 6" overhang on approach side center drawer, arm slide right box/file pedestal	36 72 29 <small>APPROACH: 6" KNEESPACE: 31"</small>	class 125 cwt 215 lb cu ft 53	<b>4,556 W</b>  <b>4,132 P</b>	<b>4,922 W</b>  <b>4,463 P</b>
	<b>D1366R</b> - _ - _	single pedestal desk right box/file pedestal includes center drawer arm slide	36 66 29 <small>APPROACH: 6" KNEESPACE: 25"</small>	class 125 cwt 205 lb cu ft 48	<b>4,867 W</b>  <b>4,386 P</b>	<b>5,255 W</b>  <b>4,739 P</b>
	<b>D1366L</b> - _ - _	single pedestal desk left box/file pedestal includes center drawer arm slide	36 66 29 <small>APPROACH: 6" KNEESPACE: 25"</small>	class 125 cwt 205 lb cu ft 48	<b>4,867 W</b>  <b>4,386 P</b>	<b>5,255 W</b>  <b>4,739 P</b>
	<b>D136630R</b> - _ - _	single pedestal desk right box/file pedestal includes center drawer arm slide	30 66 29 <small>APPROACH: 6" KNEESPACE: 25"</small>	class 125 cwt 195 lb cu ft 40	<b>4,484 W</b>  <b>4,056 P</b>	<b>4,842 W</b>  <b>4,380 P</b>
	<b>D136630L</b> - _ - _	single pedestal desk left box/file pedestal includes center drawer arm slide	30 66 29 <small>APPROACH: 6" KNEESPACE: 25"</small>	class 125 cwt 195 lb cu ft 40	<b>4,484 W</b>  <b>4,056 P</b>	<b>4,842 W</b>  <b>4,380 P</b>
	<b>D1360R</b> - _ - _	single pedestal desk right box/file pedestal includes center drawer arm slide	30 60 29 <small>KNEESPACE: 23"</small>	class 125 cwt 180 lb cu ft 37	<b>3,987 W</b>  <b>3,573 P</b>	<b>4,305 W</b>  <b>3,857 P</b>
	<b>D1360L</b> - _ - _	single pedestal desk left box/file pedestal includes center drawer arm slide	30 60 29 <small>KNEESPACE: 23"</small>	class 125 cwt 180 lb cu ft 37	<b>3,987 W</b>  <b>3,573 P</b>	<b>4,305 W</b>  <b>3,857 P</b>
	<b>D1342R</b> - _ - _	single pedestal desk right box/file pedestal includes center drawer and arm slide	30 42 29 <small>KNEESPACE: 23.5"</small>	class 125 cwt 180 lb cu ft 26	<b>3,362 W</b>  <b>3,069 P</b>	<b>3,631 W</b>  <b>3,313 P</b>

top  
P laminate top  
W veneer top

edge



oxford

| 1300 series

| wood top, veneer chassis, veneer drawer fronts  
| laminate top, veneer chassis, veneer drawer fronts

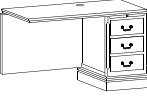
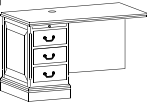
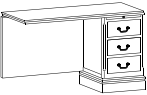
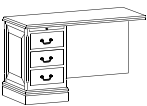
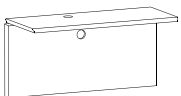
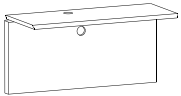
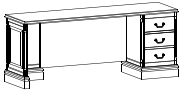
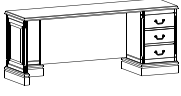

	model number		d w h	freight	list \$ zone 1	list \$ zone 2
	<b>D1342L</b> - _ - _	single pedestal desk left box/file pedestal includes center drawer and arm slide	30 42 29 <i>KNEESPACE: 23.5"</i>	class 125 cwt 180 lb cu ft 26	<b>3,362 W</b>  <b>3,069 P</b>	<b>3,631 W</b>  <b>3,313 P</b>
[ QS ] 	<b>R1348R-EH</b> - _ - _	single pedestal return right box/file pedestal  <i>NOT RECOMMENDED FOR D1360</i>	24 48 29 <i>KNEESPACE: 30"</i>	class 125 cwt 165 lb cu ft 25	<b>2,228 W</b>  <b>1,968 P</b>	<b>2,407 W</b>  <b>2,128 P</b>
[ QS ] 	<b>R1348L-EH</b> - _ - _	single pedestal return left box/file pedestal  <i>NOT RECOMMENDED FOR D1360</i>	24 48 29 <i>KNEESPACE: 30"</i>	class 125 cwt 165 lb cu ft 25	<b>2,228 W</b>  <b>1,968 P</b>	<b>2,407 W</b>  <b>2,128 P</b>
	<b>R134820R-EH</b> - _ - _	single pedestal return right box/file pedestal  <i>FOR USE WITH A D1360 DESK</i>	20 48 29 <i>KNEESPACE: 30"</i>	class 125 cwt 160 lb cu ft 25	<b>2,228 W</b>  <b>1,968 P</b>	<b>2,407 W</b>  <b>2,128 P</b>
	<b>R134820L-EH</b> - _ - _	single pedestal return left box/file pedestal  <i>FOR USE WITH A D1360 DESK</i>	20 48 29 <i>KNEESPACE: 30"</i>	class 125 cwt 160 lb cu ft 25	<b>2,228 W</b>  <b>1,968 P</b>	<b>2,407 W</b>  <b>2,128 P</b>
	<b>B1348-EH</b> - _ - _	bridge open kneespace	20 48 29 <i>KNEESPACE: 48"</i>	class 125 cwt 65 lb cu ft 3	<b>789 W</b>  <b>693 P</b>	<b>853 W</b>  <b>749 P</b>
	<b>B134824-EH</b> - _ - _	bridge open kneespace	24 48 29	class 125 cwt 65 lb cu ft 3	<b>791 W</b>  <b>714 P</b>	<b>854 W</b>  <b>771 P</b>
	<b>C1372R</b> - _ - _	single pedestal credenza right box/file pedestal	20 72 29 <i>KNEESPACE: 34"</i>	class 125 cwt 180 lb cu ft 28	<b>3,041 W</b>  <b>2,642 P</b>	<b>3,280 W</b>  <b>2,852 P</b>
	<b>C137224R</b> - _ - _	single pedestal credenza right box/file pedestal	24 72 29	class 125 cwt 180 lb cu ft 28	<b>3,226 W</b>  <b>2,758 P</b>	<b>3,483 W</b>  <b>2,978 P</b>

**laminate**  
tops only

**6LC-P** light cherry on cherry  
**7MC-P** medium cherry on cherry  
**8DC-P** dark cherry on cherry

**veneer**  
tops only

**6LC-W** light cherry on cherry  
**7MC-W** medium cherry on cherry  
**8DC-W** dark cherry on cherry  
**9BC-W** burgundy cherry on cherry  
**1NC-W** natural cherry on cherry  
**2HC-W** honey cherry on cherry

oxford  
1300

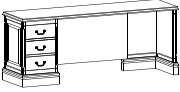
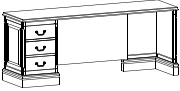
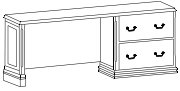
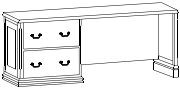
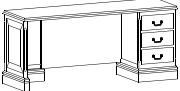
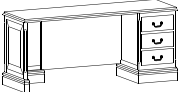
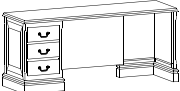
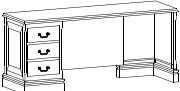
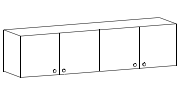

	model number	description	d	w	h	freight	list \$ zone 1	list \$ zone 2
	C1372L - _ - _	single pedestal credenza left box/file pedestal	20	72	29	class 125 cwt 180 lb cu ft 28  <i>KNEESPACE: 34"</i>	3,041 W  2,642 P	3,280 W  2,852 P
	C137224L - _ - _	single pedestal credenza left box/file pedestal	24	72	29	class 125 cwt 180 lb cu ft 28	3,226 W  2,758 P	3,483 W  2,978 P
	C1372R-2F - _ - _	single pedestal credenza right lateral file pedestal	20	72	29	class 125 cwt 225 lb cu ft 28  <i>KNEESPACE: 22"</i>	3,609 W  3,209 P	3,897 W  3,465 P
	C1372L-2F - _ - _	single pedestal credenza left lateral file pedestal	20	72	29	class 125 cwt 225 lb cu ft 28	3,609 W  3,209 P	3,897 W  3,465 P
	C1366R - _ - _	single pedestal credenza right box/file pedestal	20	66	29	class 125 cwt 170 lb cu ft 26  <i>KNEESPACE: 22"</i>	2,817 W  2,451 P	3,044 W  2,646 P
	C136624R - _ - _	single pedestal credenza right box/file pedestal	24	66	29	class 125 cwt 170 lb cu ft 26	3,003 W  2,595 P	3,243 W  2,803 P
	C1366L - _ - _	single pedestal credenza left box/file pedestal	20	66	29	class 125 cwt 170 lb cu ft 26  <i>KNEESPACE: 28"</i>	2,817 W  2,451 P	3,044 W  2,646 P
	C136624L - _ - _	single pedestal credenza left box/file pedestal	24	66	29	class 125 cwt 170 lb cu ft 26	3,003 W  2,595 P	3,243 W  2,803 P
	WH1366 - _ - _	66" wide wall hung overhead unit four hinged doors	16	66	16	class 125 cwt 110 lb cu ft 13	1,792	1,935

top

P laminate top  
W veneer top

edge





oxford

| 1300 series

| wood top, veneer chassis, veneer drawer fronts  
| laminate top, veneer chassis, veneer drawer fronts

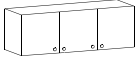
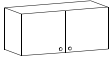
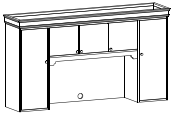
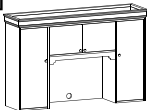
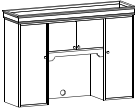
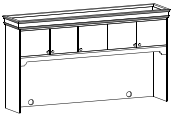
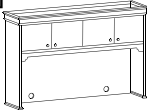
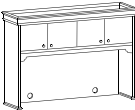

	model number		d	w	h	freight	list \$ zone 1	list \$ zone 2
	WH1348 - __ - __	48" wide wall hung overhead unit three hinged doors	16	48	16	class 125 cwt 90 lb cu ft 10	1,541	1,665
	WH1336 - __ - __	36" wide wall hung overhead unit two hinged doors	16	36	16	class 125 cwt 75 lb cu ft 7	1,010	1,090
	FH1384 - __ - __	84" wide overhead storage unit two full hinged doors three half hinged doors two wire management grommet 4 adjustable shelves	17.5	82.5	46.25	class 125 cwt 260 lb cu ft 40	5,752	6,212
[ QS ] 	FH1372 - __ - __ Quick Ship available in 8DC dark cherry	72" wide overhead storage unit two full hinged doors two half hinged doors two wire management grommet 4 adjustable shelves	17.5	71	46.25	class 125 cwt 260 lb cu ft 40 OPENING: 24.25"	5,001	5,388
	FH1366 - __ - __	66" wide overhead storage unit two full hinged doors two half hinged doors two wire management grommet 4 adjustable shelves	17.5	65	46.25	class 125 cwt 247 lb cu ft 38 OPENING: 24.25"	4,823	5,210
	OU1384 - __ - __	84" wide overhead storage unit five hinged doors three wire management grommets	17.5	82.5	46.25	class 125 cwt 210 lb cu ft 40 OPENING: 25.63"	5,069	5,474
[ QS ] 	OU1372 - __ - __ Quick Ship available in 8DC dark cherry	72" wide overhead storage unit four hinged doors three wire management grommets	17.5	71	46.25	class 125 cwt 210 lb cu ft 40 OPENING: 25.63"	4,319	4,677
	OU1366 - __ - __	66" overhead storage unit four hinged doors three wire management grommets	17.5	65	46.25	class 125 cwt 190 lb cu ft 38 OPENING: 25.63"	3,907	4,382
	OU1348 - __ - __	48" overhead storage unit three hinged doors three wire management grommets	17.5	47	46.25	class 125 cwt 210 lb cu ft 40 OPENING: 25.63"	3,358	3,626





laminates  
tops only

6LC-P light cherry on cherry  
7MC-P medium cherry on cherry  
8DC-P dark cherry on cherry

veneers  
tops only

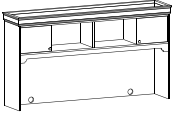
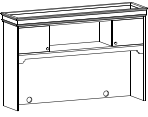
6LC-W light cherry on cherry  
7MC-W medium cherry on cherry  
8DC-W dark cherry on cherry  
9BC-W burgundy cherry on cherry  
1NC-W natural cherry on cherry  
2HC-W honey cherry on cherry

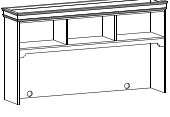
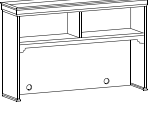
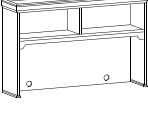
oxford  
1300

	model number	description	d w h	freight	list \$ zone 1	list \$ zone 2
	OU1336 - _ - _	36" overhead storage unit two wire management grommets	17.5 35 46.25 <i>OPENING: 25.63"</i>	class 125 cwt 210 lb cu ft 40	<b>2,941</b>	<b>3,176</b>
	OD1384 - _ - _	84" overhead storage unit with open center one hinged door on each end three wire management grommets	17.5 82.5 46.25 <i>OPENING: 25.63"</i>	class 125 cwt 210 lb cu ft 40	<b>4,777</b>	<b>5,159</b>
	OD1372 - _ - _	72" overhead storage unit with open center one hinged door on each end three wire management grommets	17.5 71 46.25 <i>OPENING: 25.63"</i>	class 125 cwt 210 lb cu ft 40	<b>4,026</b>	<b>4,357</b>
	OD1366 - _ - _	66" overhead storage unit with open center one hinged door on each end three wire management grommets	17.5 65 46.25 <i>OPENING: 25.63"</i>	class 125 cwt 190 lb cu ft 38	<b>3,614</b>	<b>3,914</b>
	OO1384 - _ - _	84" open overhead storage unit with open center three wire management grommets	17.5 82.5 46.25 <i>OPENING: 25.63"</i>	class 125 cwt 210 lb cu ft 40	<b>4,229</b>	<b>4,568</b>
	OO1372 - _ - _	72" open overhead storage unit with open center three wire management grommets	17.5 71 46.25 <i>OPENING: 25.63"</i>	class 125 cwt 185 lb cu ft 38	<b>3,478</b>	<b>3,757</b>
	OO1366 - _ - _	66" open overhead storage unit with open center three wire management grommets	17.5 65 46.25 <i>OPENING: 25.63"</i>	class 125 cwt 175 lb cu ft 38	<b>3,312</b>	<b>3,576</b>
	USU84 - _	underside paper storage for use with 84" storage overhead units does not prevent the use of task lights or tackboards  <i>FACTORY INSTALLED</i>	15.5 82 4	class cwt lb cu ft	<b>512</b>	<b>554</b>
	USU72 - _	underside paper storage for use with 72" storage overhead units does not prevent the use of task lights or tackboards  <i>FACTORY INSTALLED</i>	15.5 70 4	class cwt lb cu ft	<b>498</b>	<b>536</b>

top

**P** laminate top  
**W** veneer top



edge



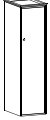
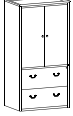
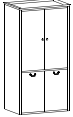
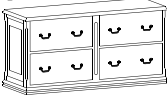
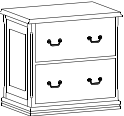

	model number		d	w	h	freight	list \$ zone 1	list \$ zone 2
	<b>USU66</b> - _ _	underside paper storage for use with 66" storage overhead units does not prevent the use of task lights or tackboards  <i>FACTORY INSTALLED</i>	15.5	64	4	class cwt lb cu ft	<b>498</b>	<b>536</b>
	<b>USU48</b> - _ _	underside paper storage for use with 48" storage overhead units does not prevent the use of task lights or tackboards  <i>FACTORY INSTALLED</i>	15.5	46	4	class cwt lb cu ft	<b>292</b>	<b>315</b>
	<b>USU36</b> - _ _	underside paper storage for use with 36" storage overhead units does not prevent the use of task lights or tackboards  <i>FACTORY INSTALLED</i>	15.5	34	4	class cwt lb cu ft	<b>292</b>	<b>315</b>
	<b>H1329</b> - _ _ - _	open hutch two adjustable shelves  <i>SET UNIT ON HW1330 OR 2FD1330</i>  <i>SOLID WOOD SHELVES (EACH) \$28</i> <i>ADDITIONAL SHELVES (EACH) \$92</i>	13	29	47	class 125 cwt 75 lb cu ft 13	<b>2,031</b>	<b>2,193</b>
	<b>H1357</b> - _ _ - _	open hutch two adjustable shelves each side  <i>SET UNIT ON 4FD1360</i>  <i>SOLID WOOD SHELVES (EACH) \$28</i> <i>ADDITIONAL SHELVES (EACH) \$92</i>	13	57	47	class 125 cwt 75 lb cu ft 13	<b>3,131</b>	<b>3,378</b>
	<b>HW13722F</b> - _ _ - _	storage cabinet hinged doors with two adjustable shelves upper, lateral file below  <i>SOLID WOOD SHELVES (EACH) \$28</i> <i>ADDITIONAL SHELVES (EACH) \$92</i> <i>CORNICE TOP (UPCHARGE) 202</i>	24	36	72	class 125 cwt 320 lb cu ft 43	<b>5,199</b>	<b>5,615</b>
	<b>HW1372HW</b> - _ _ - _	storage cabinet hinged doors with two adjustable shelves upper and one adjustable shelf below  <i>SOLID WOOD SHELVES (EACH) \$28</i> <i>ADDITIONAL SHELVES (EACH) \$92</i> <i>CORNICE TOP (UPCHARGE) 202</i>	24	36	72	class 125 cwt 270 lb cu ft 43	<b>4,980</b>	<b>5,385</b>
[ QS ]	<b>HW1330</b> - _ _ - _  Quick Ship available in 8DC dark cherry with veneer top or laminate top	hinged door cabinet two wood doors one adjustable shelf  <i>SOLID WOOD SHELVES (EACH) \$28</i> <i>ADDITIONAL SHELVES (EACH) \$92</i>	20	30	29	class 125 cwt 100 lb cu ft 13	<b>2,137 W</b>  <b>1,845 P</b>	<b>2,305 W</b>  <b>1,993 P</b>
	<b>WD1372</b> - _ _ - _	wardrobe right side coat storage, left side three adjustable shelves storage shelf above  <i>ADDITIONAL SHELVES (EACH) \$92</i> <i>CORNICE TOP (UPCHARGE) \$202</i>	24	36	72	class 125 cwt 285 lb cu ft 42	<b>3,728</b>	<b>4,027</b>

<b>laminate</b> tops only	<b>6LC-P</b> light cherry on cherry <b>7MC-P</b> medium cherry on cherry <b>8DC-P</b> dark cherry on cherry
<b>veneer</b> tops only	<b>6LC-W</b> light cherry on cherry <b>7MC-W</b> medium cherry on cherry <b>8DC-W</b> dark cherry on cherry <b>9BC-W</b> burgundy cherry on cherry <b>1NC-W</b> natural cherry on cherry <b>2HC-W</b> honey cherry on cherry

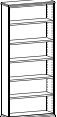
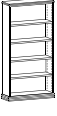
	model number	description	d	w	h	freight	list \$ zone 1	list \$ zone 2
	<b>WD1372R-18</b> - __ - __  <b>WD1372L-18</b> - __ - __	wardrobe/coat storage one hinged door, hanging rod (R) hinge on right/knob on left (L) hinge on left/knob on right  <i>ADDITIONAL SHELVES (EACH) \$92</i> <i>CORNICE TOP (UPCHARGE) \$202</i>	24	18	72	class 125 cwt 170 lb cu ft 23	<b>2,682</b>	<b>2,938</b>
	<b>AV13722F</b> - __ - __	tv cabinet pocket doors with pull-out swivel tv tray upper lateral file below  <i>CORNICE TOP (UPCHARGE) \$202</i>	24	36	72	class 125 cwt 340 lb cu ft 43	<b>5,957</b>	<b>6,433</b>
	<b>AV1372HW</b> - __ - __	tv cabinet pocket doors with pull-out swivel tv tray upper hinged doors w/adjustable shelf below  <i>ADDITIONAL SHELVES (EACH) \$92</i> <i>CORNICE TOP (UPCHARGE) \$202</i>	d 24 w 36 h 72			class 125 cwt 290 lb cu ft 43	<b>5,754</b>	<b>6,217</b>
[ QS ] 	<b>4FD1360</b> - __ - __  Quick Ship available in 8DC dark cherry with laminate top only	lateral file/four drawers two drawer side by side under common top letter and legal capacity	20	60	29	class 125 cwt 225 lb cu ft 26	<b>5,118 W</b>  <b>4,635 P</b>	<b>5,528 W</b>  <b>5,005 P</b>
[ QS ] 	<b>2FD1330</b> - __ - __  Quick Ship available in 8DC dark cherry with veneer top or laminated top	lateral file letter and legal capacity	20	30	29	class 125 cwt 125 lb cu ft 13	<b>2,560 W</b>  <b>2,270 P</b>	<b>2,765 W</b>  <b>2,451 P</b>
	<b>MP132F</b> - __ - __	mobile pedestal file/file with locking casters and no tip mechanism for use under 29" high surface black top	18.9	16.6	27.3	class 125 cwt 145 lb cu ft 28	<b>1,217</b>	<b>1,315</b>
	<b>MP133D</b> - __ - __	mobile pedestal box/box/file with locking casters and no tip mechanism for use under 29" high surface black top	18.9	16.6	27.3	class 125 cwt 145 lb cu ft 28	<b>1,232</b>	<b>1,331</b>
	<b>BC1384</b> - __ - __	bookcase four adjustable shelves one fixed shelf in center  <i>SOLID WOOD SHELVES (EACH) \$28</i> <i>ADDITIONAL SHELVES (EACH) \$92</i>	12	36	84	class 125 cwt 145 lb cu ft 28	<b>1,925 W</b>  <b>1,814 P</b>	<b>2,073 W</b>  <b>1,956 P</b>
	<b>BC1372</b> - __ - __	bookcase three adjustable shelves one fixed shelf in center  <i>SOLID WOOD SHELVES (EACH) \$28</i> <i>ADDITIONAL SHELVES (EACH) \$92</i>	12	36	72	class 125 cwt 135 lb cu ft 24	<b>1,735 W</b>  <b>1,624 P</b>	<b>1,867 W</b>  <b>1,756 P</b>

top  
P laminate top  
W veneer top

edge







oxford

1300 series

| wood top, veneer chassis, veneer drawer fronts  
| laminate top, veneer chassis, veneer drawer fronts





	model number		d	w	h	freight	list \$ zone 1	list \$ zone 2
	BC1360 - _ - _	bookcase two adjustable shelves one fixed shelf in center  <i>SOLID WOOD SHELVES (EACH) \$28</i> <i>ADDITIONAL SHELVES (EACH) \$92</i>	12	36	60	class 125 cwt 110 lb cu ft 20	<b>1,462 W</b>  <b>1,354 P</b>	<b>1,580 W</b>  <b>1,461 P</b>
	BC1348 - _ - _	bookcase one adjustable shelf one fixed shelf  <i>SOLID WOOD SHELVES (EACH) \$28</i> <i>ADDITIONAL SHELVES (EACH) \$92</i>	12	36	48	class 125 cwt 96 lb cu ft 16	<b>1,264 W</b>  <b>1,155 P</b>	<b>1,364 W</b>  <b>1,245 P</b>
	BC1336 - _ - _	bookcase two adjustable shelves  <i>SOLID WOOD SHELVES (EACH) \$28</i> <i>ADDITIONAL SHELVES (EACH) \$92</i>	12	36	36	class 125 cwt 85 lb cu ft 12	<b>1,090 W</b>  <b>983 P</b>	<b>1,178 W</b>  <b>1,061 P</b>
	BC1330 - _ - _	bookcase one adjustable shelf  <i>SOLID WOOD SHELVES (EACH) \$28</i> <i>ADDITIONAL SHELVES (EACH) \$92</i>	12	36	30	class 125 cwt 80 lb cu ft 11	<b>974 W</b>  <b>864 P</b>	<b>1,051 W</b>  <b>934 P</b>

**laminate**  
tops only

**6LC-P** light cherry on cherry  
**7MC-P** medium cherry on cherry  
**8DC-P** dark cherry on cherry

**veneer**  
tops only

**6LC-W** light cherry on cherry  
**7MC-W** medium cherry on cherry  
**8DC-W** dark cherry on cherry  
**9BC-W** burgundy cherry on cherry  
**1NC-W** natural cherry on cherry  
**2HC-W** honey cherry on cherry

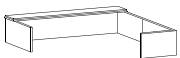
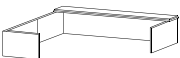
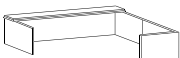
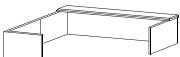
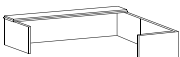
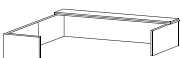
	model number	description	d	w	h	freight	list \$ zone 1	list \$ zone 2
	TD1372 - _ - _	desk top transaction counter for use with 72" desk only	12	72	15.25	class 125 cwt 90 lb cu ft 6	1,118 W  1,118 P	1,202 W  1,202 P
	TD1366 - _ - _	desk top transaction counter for use with 36" x 66" desk only	12	66	15.25	class 125 cwt 84 lb cu ft 6	1,118 W  1,118 P	1,202 W  1,202 P
	TD136630 - _ - _	desk top transaction counter for use with 30" x 66" desk only	12	66	15.25	class 125 cwt 84 lb cu ft 6	1,118 W  1,118 P	1,202 W  1,202 P
	TM1372R - _ - _	desk top transaction/reception gallery for use with 72" right executive "I" unit only  <i>GALLERY 84 x 72 x 14</i>	12	72	15.25	class 125 cwt 100 lb cu ft 6	1,653 W  1,653 P	1,777 W  1,777 P
	TM1372L - _ - _	desk top transaction/reception gallery for use with 72" left executive "I" unit only  <i>GALLERY 84 x 72 x 14</i>	12	72	15.25	class 125 cwt 100 lb cu ft 6	1,653 W  1,653 P	1,777 W  1,777 P
	TM1366R - _ - _	desk top transaction/reception gallery for use with 36" x 66" right executive "I" unit only  <i>GALLERY 84 x 66 x 14</i>	12	66	15.25	class 125 cwt 94 lb cu ft 6	1,653 W  1,653 P	1,777 W  1,777 P
	TM1366L - _ - _	desk top transaction/reception gallery for use with 36" x 66" left executive "I" unit only  <i>GALLERY 84 x 66 x 14</i>	12	66	15.25	class 125 cwt 94 lb cu ft 6	1,653 W  1,653 P	1,777 W  1,777 P
	TM136630R - _ - _	desk top transaction/reception gallery for use with 30" x 66" right executive "I" unit only  <i>GALLERY 78 x 66 x 14</i>	12	66	15.25	class 125 cwt 94 lb cu ft 6	1,653 W  1,653 P	1,777 W  1,777 P
	TM136630L - _ - _	desk top transaction/reception gallery for use with 30" x 66" left executive "I" unit only  <i>GALLERY 78 x 66 x 14</i>	12	66	15.25	class 125 cwt 94 lb cu ft 6	1,653 W  1,653 P	1,777 W  1,777 P

top  
P laminate top  
W veneer top

edge



oxford

1300 series

wood top, veneer chassis, veneer drawer fronts  
 laminate top, veneer chassis, veneer drawer fronts



	model number		d	w	h	freight	list \$ zone 1	list \$ zone 2
	<b>TM1360R</b> - _ - _	desk top transaction/reception gallery for use with 60" right executive "I" unit only  <i>GALLERY 78 x 60 x 14</i>	12	60	15.25	class 125 cwt 90 lb cu ft 6	<b>1,653 W</b>  <b>1,653 P</b>	<b>1,777 W</b>  <b>1,777 P</b>
	<b>TM1360L</b> - _ - _	desk top transaction/reception gallery for use with 60" left executive "I" unit only  <i>GALLERY 78 x 60 x 14</i>	12	60	15.25	class 125 cwt 90 lb cu ft 6	<b>1,653 W</b>  <b>1,653 P</b>	<b>1,777 W</b>  <b>1,777 P</b>
	<b>TU1372R</b> - _ - _	desk top transaction/reception gallery for use with 72" right executive "u" unit only  <i>GALLERY 104 x 72 x 14</i>	12	72	15.25	class 125 cwt 150 lb cu ft 8	<b>2,234 W</b>  <b>2,234 P</b>	<b>2,406 W</b>  <b>2,406 P</b>
	<b>TU1372L</b> - _ - _	desk top transaction/reception gallery for use with 72" left executive "u" unit only  <i>GALLERY 104 x 72 x 14</i>	12	72	15.25	class 125 cwt 150 lb cu ft 8	<b>2,234 W</b>  <b>2,234 P</b>	<b>2,406 W</b>  <b>2,406 P</b>
	<b>TU1366R</b> - _ - _	desk top transaction/reception gallery for use with 36" x 66" right executive "u" unit only  <i>GALLERY 104 x 66 x 14</i>	12	66	15.25	class 125 cwt 140 lb cu ft 8	<b>2,234 W</b>  <b>2,234 P</b>	<b>2,406 W</b>  <b>2,406 P</b>
	<b>TU1366L</b> - _ - _	desk top transaction/reception gallery for use with 36" x 66" left executive "u" unit only  <i>GALLERY 104 x 66 x 14</i>	12	66	15.25	class 125 cwt 140 lb cu ft 8	<b>2,234 W</b>  <b>2,234 P</b>	<b>2,406 W</b>  <b>2,406 P</b>
	<b>TU136630R</b> - _ - _	desk top transaction/reception gallery for use with 30" x 66" right executive "u" unit only  <i>GALLERY 98 x 66 x 14</i>	12	66	15.25	class 125 cwt 140 lb cu ft 8	<b>2,234 W</b>  <b>2,234 P</b>	<b>2,406 W</b>  <b>2,406 P</b>
	<b>TU136630L</b> - _ - _	desk top transaction/reception gallery for use with 30" x 66" left executive "u" unit only  <i>GALLERY 98 x 66 x 14</i>	12	66	15.25	class 125 cwt 140 lb cu ft 8	<b>2,234 W</b>  <b>2,234 P</b>	<b>2,406 W</b>  <b>2,406 P</b>
	<b>T1348-29</b> - _ - _	sofa table  <i>CAN SHIP UPS</i>	18	48	29	class 85 cwt 50 lb cu ft 3	<b>1,084 W</b>  <b>785 P</b>	<b>1,168 W</b>  <b>849 P</b>

**laminate**  
tops only

**6LC-P** light cherry on cherry  
**7MC-P** medium cherry on cherry  
**8DC-P** dark cherry on cherry

**veneer**  
tops only

**6LC-W** light cherry on cherry  
**7MC-W** medium cherry on cherry  
**8DC-W** dark cherry on cherry  
**9BC-W** burgundy cherry on cherry  
**1NC-W** natural cherry on cherry  
**2HC-W** honey cherry on cherry

oxford  
1300

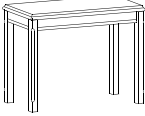
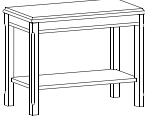
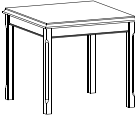
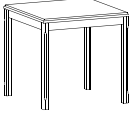
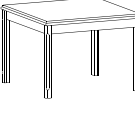
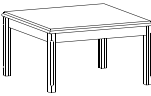
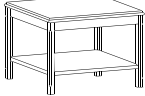

	model number	description	d	w	h	freight	list \$ zone 1	list \$ zone 2
	T1348 - _ - _	lamp table  <i>CAN SHIP UPS</i>	18	48	17	class 85 cwt 40 lb cu ft 3	<b>861 W</b>  <b>565 P</b>	<b>930 W</b>  <b>608 P</b>
	ET1328 - _ - _	end table	28	15	22	class 150 cwt 26 lb cu ft 2	<b>590 W</b>  <b>435 P</b>	<b>639 W</b>  <b>468 P</b>
	ET1328S - _ - _	end table with shelf  <i>CAN SHIP UPS</i>	28	15	22	class 85 cwt 30 lb cu ft 2	<b>733 W</b>  <b>579 P</b>	<b>793 W</b>  <b>627 P</b>
	T1324-22 - _ - _	lamp table	24	24	22	class 85 cwt 50 lb cu ft 3	<b>647 W</b>  <b>468 P</b>	<b>697 W</b>  <b>508 P</b>
	T1330-29 - _ - _	lamp table  <i>CAN SHIP UPS</i>	30	30	29	class 85 cwt 50 lb cu ft 3	<b>1,069 W</b>  <b>735 P</b>	<b>1,152 W</b>  <b>796 P</b>
	T1330-22 - _ - _	lamp table  <i>CAN SHIP UPS</i>	30	30	22	class 85 cwt 45 lb cu ft 3	<b>849 W</b>  <b>516 P</b>	<b>914 W</b>  <b>558 P</b>
	T1330-17 - _ - _	lamp table  <i>CAN SHIP UPS</i>	30	30	17	class 85 cwt 46 lb cu ft 3	<b>808 W</b>  <b>476 P</b>	<b>869 W</b>  <b>513 P</b>
	T1330S - _ - _	lamp table with shelf  <i>CAN SHIP UPS</i>	30	30	22	class 85 cwt 15 lb cu ft 5	<b>1,108 W</b>  <b>775 P</b>	<b>1,192 W</b>  <b>837 P</b>

top

**P** laminate top  
**W** veneer top

edge





oxford

1300 series

| wood top, veneer chassis, veneer drawer fronts  
| laminate top, veneer chassis, veneer drawer fronts

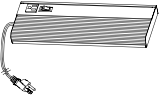
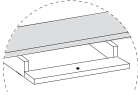
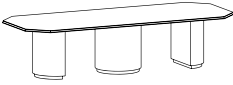
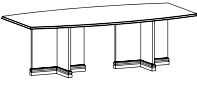

	model number		d	w	h	freight	list \$ zone 1	list \$ zone 2
	<b>TL24</b>	task light for use with overhead storage units  <i>FIELD INSTALLED ONLY</i>	7	24	2	class 100 cwt 11 lb cu ft 1	<b>335</b>	<b>364</b>
	<b>KBCD-I</b>	keyboard drawer with lock styled as center drawer with drop front drawer pulls out for keyboard use *indicate which series (NOT available in Muse, Progeny, Trek or Brio)  <i>FACTORY INSTALLED ONLY, SPECIFY GROMMET LOCATION</i>	14		4	class cwt lb cu ft	<b>585</b>	<b>585</b>
	<b>OW120</b> <b>DB-24</b> 1 for above top <b>1/2 R-DB-24</b> 2 for above top	octagonal table (2 piece laminate top)	120	48	36	cwt 235 lb  cwt 55 lb  cwt 40 lb	<b>6,115</b>	<b>6,548</b>  as shown
	<b>BO9648</b> veneer top/wood edge  <b>XB13-30</b> 2 for above top	boat shape table top with X style base  X style base with oxford styling	96	48		cwt 185 lb  cwt 70 lb	<b>5,225</b>	<b>5,570</b>  as shown
	<b>CW60</b> laminate top/wood edge  <b>LT (set)</b>	circular top with LT legs  4 hardwood legs with apron		60		cwt 75 lb  cwt 16 lb	<b>1,786</b>	<b>1,928</b>  as shown

laminate tops only	<b>6LC-P</b>	light cherry on cherry
	<b>7MC-P</b>	medium cherry on cherry
	<b>8DC-P</b>	dark cherry on cherry
veneer tops only	<b>6LC-W</b>	light cherry on cherry
	<b>7MC-W</b>	medium cherry on cherry
	<b>8DC-W</b>	dark cherry on cherry
	<b>9BC-W</b>	burgundy cherry on cherry
	<b>1NC-W</b>	natural cherry on cherry
	<b>2HC-W</b>	honey cherry on cherry

# inwood

OFFICE  
ENVIRONMENTS

## price list

effective 01 january 2012

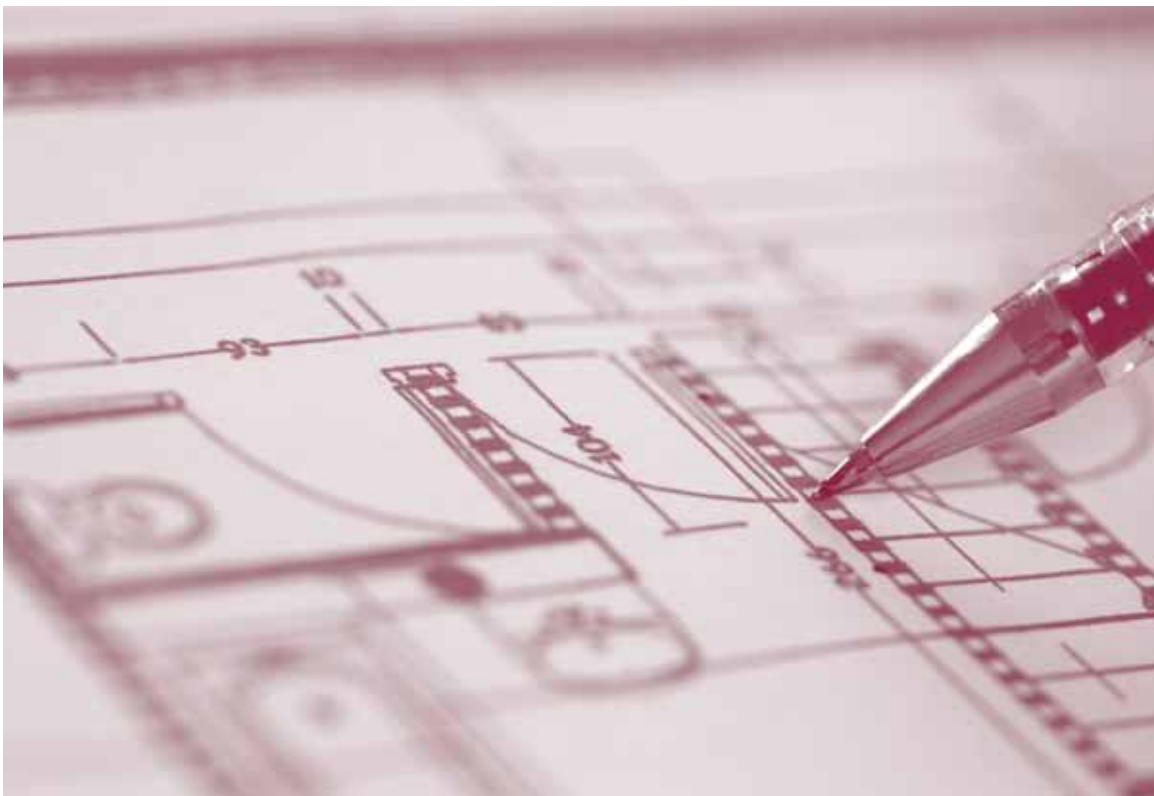

account # \_\_\_\_\_  
discount \_\_\_\_\_  
zone \_\_\_\_\_  
c.s.r. \_\_\_\_\_  
sales rep. \_\_\_\_\_

### monticello/ empire

1900/1800

[click here for warranty  
and terms information](#)

zones one and two



# inwood

OFFICE  
ENVIRONMENTS

monticello/empire  
1900/1800



**monticello 1900 series specifications**  
**empire 1800 series specifications**

**materials:**

All wood is thoroughly air and kiln dried to a moisture content not to exceed 8% at time of assembly.

**veneers:**

All exposed surfaces are plain sliced american black walnut. Veneers are carefully book-matched and balanced. All drawer fronts, doors, end panels, and modesty panels are vertical grain genuine walnut.

**top work surfaces:**

- **wood veneer tops** are 1 1/4" thick, 5-ply construction, consisting of 1/40" thick walnut veneer work surfaces and poplar veneer backing. The top core material is a 45 lb density particleboard, with a traditional shape solid wood rim on all four sides.
- **high pressure laminate tops** are 1 1/4", 3-ply construction; consisting of a high-pressure laminate work surface and a 45 lb density particle board core. The under side of the top has a smooth surface Gator-Ply backing sheet. Top rims are solid hardwood with a traditional edge shape.

**pedestal construction:**

3/4" thick 3-ply construction; consisting of american black walnut veneer on all exposed surfaces and a 45 lb density particle board core. Each pedestal in desk units has a 3-ply dictation arm slide mounted above the drawers. In the desk and credenza units each pedestal has one box drawer over one file drawer. The base is constructed and shaped in veneer wrapped MDF; adjustable leveling glides are mounted in each corner of the base (Bases are available with bracket style base at no additional charge). All joints are reinforced with concealed wood glue blocks. All trim molding is solid hardwood. A full mortise and tenon and glue join the cabinet sides. All bookcase shelves are standard 3/4" thick.

**drawers:**

Drawer fronts are 3/4" thick, 3-ply construction with vertical book matched walnut veneer. Drawer edges are veneered on top with matching walnut. All drawer sides and backs are solid hardwood, dovetailed front and back with 3-ply drawer bottoms. Drawer bottoms are framed on four sides and stapled from the bottom side. Drawer interiors are finished with a clear sealer to prevent swelling or shrinkage. Box drawers have a high grade sterling metal ball-bearing drawer suspension. File drawers have a high grade sterling metal ball bearing full progressive suspension and are equipped with metal rods for hanging file folders. All drawers have smooth quiet operation. Pedestals have one box drawer and one file drawer each. Each desk is standard with a felt lined center drawer with a high grade sterling suspension and a solid wood pen pencil tray.

**inside drawer dimensions:**

- box drawers: 4" H x 12 1/8" W x 15 9/16" L
- 4" H x 12 1/8" W x 22 1/8" L
- file drawers: 9 1/2" H x 12 1/8" W x 15 9/16" L
- 9 1/2" H x 12 1/8" W x 25 3/8" L
- lateral files: 9 1/2" H x 32 5/8" W x 16" L

**locking:**

Each pedestal has its own locking mechanism that also locks the center drawer. Each unit is equipped with two keys. Units may be keyed alike in groups (per office, if requested) for an additional charge of \$37 list per unit.

**finish:**

All Inwood finishes are catalyzed varnish and have excellent durability. Our multi-step satin finishes leave an open grain natural look to the furniture, and are available in the following finishes: (3L) saddle on walnut, (2KL) sepia on walnut, (25M) mahogany on walnut, (4L) dark mahogany on walnut, and (25C) cherry on walnut. Laminate options are (3L) saddle on walnut, (4L) dark mahogany on walnut, (25M) mahogany on walnut, and (25C) cherry on walnut.

**pulls/grommets:**

Drawer hardware is an Antique Brass English bail pull for monticello. Pull styles are different for 1900 and 1800 series furniture. Standard black grommets. Optional silver available (no upcharge)



1900

1800

**bracket base:**

Standard pedestal base for Monticello/Empire may be specified as a bracket base at no additional upcharge. Add (BB) after complete model number.

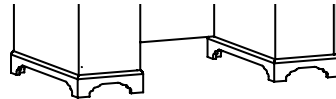

**molding:**

Monticello 1900 series furniture is shipped with picture frame molding; Empire 1800 series ships without molding.



1900



1800



monticello/empire

desks

letter  
front to back

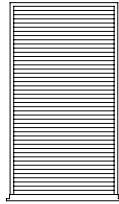

letter  
side to side

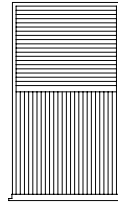

letter/legal  
combination

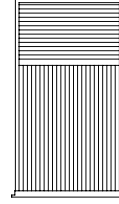

returns  
and  
credenzas

letter  
front to back

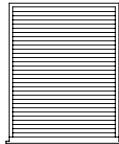

letter  
side to side

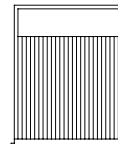

lateral files

letter  
side to side

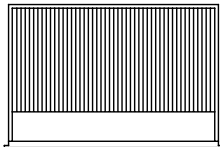



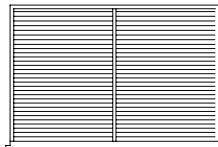

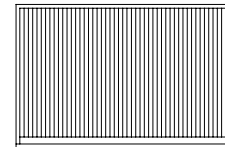

letter  
front to back

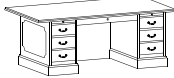

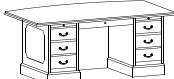
legal  
side to side

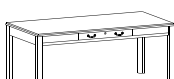
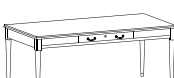
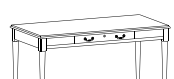

	model number	description	d w h	freight	list \$ zone 1	list \$ zone 2
	<b>CF1976</b> - _ - _  <b>CF1876</b> - _ - _	conference desk double pedestal desk with cloth-lined center drawer each pedestal has a box drawer positioned over a file drawer which is styled as 3 box drawers arm slide	42 76 29  <i>APPROACH: 6"</i> <i>KNEESPACE: 34"</i>	class 125 cwt 350 lb cu ft 64	<b>4,259 W</b> <b>3,643 P</b>  <b>4,110 W</b> <b>3,494 P</b>	<b>4,590 W</b> <b>3,932 P</b>  <b>4,425 W</b> <b>3,770 P</b>
	<b>[ QS ]</b> <b>CF1972</b> - _ - _  <b>CF1872</b> - _ - _	conference desk double pedestal desk with cloth-lined center drawer each pedestal has a box drawer positioned over a file drawer which is styled as 3 box drawers arm slide	36 72 29  <i>APPROACH: 6"</i> <i>KNEESPACE: 28"</i>	class 125 cwt 310 lb cu ft 55	<b>3,770 W</b> <b>3,204 P</b>  <b>3,672 W</b> <b>3,123 P</b>	<b>4,075 W</b> <b>3,458 P</b>  <b>3,960 W</b> <b>3,373 P</b>
	<b>CFBT1972</b> - _ - _  <b>CFBT1872</b> - _ - _	bow front conference desk double pedestal desk with cloth-lined center drawer each pedestal has a box drawer positioned over a file drawer which is styled as 3 box drawers arm slide	42 72 29  <i>APPROACH: 12"</i> <i>KNEESPACE: 28"</i>	class 125 cwt 275 lb cu ft 53	<b>5,436 W</b> <b>4,883 P</b>  <b>5,355 W</b> <b>4,804 P</b>	<b>5,854 W</b> <b>5,273 P</b>  <b>5,782 W</b> <b>5,191 P</b>
	<b>F1966</b> - _ - _  <b>F1866</b> - _ - _	desk double pedestal desk with cloth-lined center drawer each pedestal has a box drawer positioned over a file drawer which is styled as 3 box drawers arm slide	36 66 29  <i>KNEESPACE: 34"</i>	class 125 cwt 300 lb cu ft 48	<b>3,702 W</b> <b>3,188 P</b>  <b>3,659 W</b> <b>3,107 P</b>	<b>3,981 W</b> <b>3,441 P</b>  <b>3,944 W</b> <b>3,357 P</b>
	<b>F196630</b> - _ - _  <b>F186630</b> - _ - _	desk double pedestal desk with cloth-lined center drawer each pedestal has a box drawer positioned over a file drawer which is styled as 3 box drawers arm slide	30 66 29  <i>KNEESPACE: 34"</i>	class 125 cwt 285 lb cu ft 40	<b>3,612 W</b> <b>3,137 P</b>  <b>3,591 W</b> <b>3,036 P</b>	<b>3,917 W</b> <b>3,376 P</b>  <b>3,878 W</b> <b>3,278 P</b>
	<b>F1960</b> - _ - _  <b>F1860</b> - _ - _	desk double pedestal with cloth-lined center drawer each pedestal has a box drawer positioned over a file drawer which is styled as 3 box drawers arm slide	30 60 29  <i>KNEESPACE: 28"</i>	class 125 cwt 255 lb cu ft 37	<b>3,383 W</b> <b>2,891 P</b>  <b>3,264 W</b> <b>2,773 P</b>	<b>3,643 W</b> <b>3,123 P</b>  <b>3,517 W</b> <b>2,996 P</b>
	<b>T1972</b> - _ - _  <b>T1872</b> - _ - _	table desk cloth-lined center drawer square legs	36 72 29  <i>KNEESPACE: 66"</i>	class 85 kd cwt 140 lb cu ft 14	<b>2,238 W</b> <b>1,709 P</b>  <b>2,238 W</b> <b>1,709 P</b>	<b>2,410 W</b> <b>1,848 P</b>  <b>2,410 W</b> <b>1,848 P</b>
	<b>T1972TL</b> - _ - _  <b>T1872TL</b> - _ - _	table desk cloth-lined center drawer turned legs	36 72 29  <i>KNEESPACE: 66"</i>	class 85 kd cwt 135 lb cu ft 14	<b>2,398 W</b> <b>1,847 P</b>  <b>2,398 W</b> <b>1,847 P</b>	<b>2,655 W</b> <b>1,995 P</b>  <b>2,655 W</b> <b>1,995 P</b>
	<b>T1960TL</b> - _ - _  <b>T1860TL</b> - _ - _	table desk cloth-lined center drawer turned legs	30 60 29  <i>KNEESPACE: 54"</i>	class 85 kd cwt 105 lb cu ft 9	<b>2,109 W</b> <b>1,619 P</b>  <b>2,109 W</b> <b>1,619 P</b>	<b>2,273 W</b> <b>1,747 P</b>  <b>2,273 W</b> <b>1,747 P</b>

top

**P** laminate top  
**W** veneer top

to add laptop ped in any desk (min 36" deep) add \$1,162 zone 1 \ \$1,255 zone 2 list upcharge

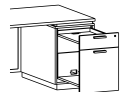

edge





monticello/empire  
1900 series with molding

1900/1800 series  
1800 series without molding

wood top, veneer chassis, veneer drawer fronts  
laminated top, veneer chassis, veneer drawer fronts

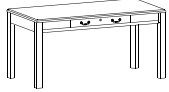
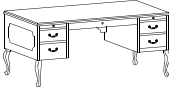
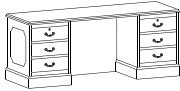
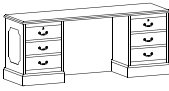
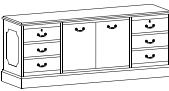
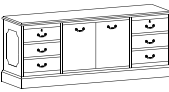
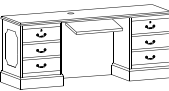

monticello/empire  
1900/1800

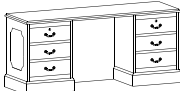
	model number	description	d w h	freight	list \$ zone 1	list \$ zone 2
	T1960 - _ - _ T1860 - _ - _	table desk cloth-lined center drawer square legs	30 60 29 <i>KNEESPACE: 54"</i>	class 85 kd cwt 110 lb cu ft 9	1,839 W 1,352 P  1,839 W 1,352 P	1,983 W 1,457 P  1,983 W 1,457 P
	DT1966 - _ - _ DT1866 - _ - _	table desk cloth-lined center drawer and arm slide queen anne legs file drawer on left with box/box on right	36 66 29 <i>KNEESPACE: 34"</i>	class 125 cwt 225 lb cu ft 27	3,506 W 2,975 P  3,407 W 2,878 P	3,786 W 3,213 P  3,682 W 3,107 P
	CR197224 - _ - _ CR187224 - _ - _	computer depth credenza left and right box/file pedestals open kneespace in center	24 72 29 <i>KNEESPACE: 40"</i>	class 125 cwt 235 lb cu ft 34	3,479 W 2,982 P  3,304 W 2,806 P	3,749 W 3,223 P  3,557 W 3,030 P
	CR1972 - _ - _ CR1872 - _ - _	kneespace credenza left and right box/file pedestals open kneespace in center	20 72 29 <i>KNEESPACE: 40"</i>	class 125 cwt 215 lb cu ft 28	3,028 W 2,599 P  2,852 W 2,424 P	3,263 W 2,806 P  3,071 W 2,616 P
	[ QS ] CR1972D - _ - _ CR1872D - _ - _	storage credenza left and right box/file pedestals double hinged door center with adjustable shelf  <i>ADDITIONAL SHELVES (EACH) \$92</i> <i>SOLID WOOD SHELVES (EACH) \$28</i>	20 72 29	class 125 cwt 255 lb cu ft 28	3,386 W 2,941 P  3,247 W 2,817 P	3,657 W 3,176 P  3,497 W 2,913 P
	CR197224D - _ - _ CR187224D - _ - _	storage credenza left and right box/file pedestals double hinged door center with adjustable shelf  <i>ADDITIONAL SHELVES (EACH) \$92</i> <i>SOLID WOOD SHELVES (EACH) \$28</i>	24 72 29	class 125 cwt 255 lb cu ft 28	3,837 W 3,324 P  3,699 W 3,200 P	4,143 W 3,590 P  3,995 W 3,455 P
	CR1972KB - _ - _ CR1872KB - _ - _	kneespace credenza with keyboard box/file pedestal on each side  <i>ARTICULATING KEYBOARD HEIGHT ADJUSTMENT FROM 26.5 - 29"</i>	20 72 29 <i>KNEESPACE: 40"</i>	class 125 cwt 225 lb cu ft 28	3,392 W 2,965 P  3,214 W 2,788 P	3,657 W 3,199 P  3,465 W 3,008 P
	CR196624 - _ - _ CR186624 - _ - _	computer depth credenza left and right box/file pedestals open kneespace in center	24 66 29 <i>KNEESPACE: 34"</i>	class 125 cwt 200 lb cu ft 30	3,454 W 2,971 P  3,201 W 2,720 P	3,718 W 3,209 P  3,451 W 2,938 P
	CR1966 - _ - _ CR1866 - _ - _	storage credenza left and right box/file pedestals open kneespace in center	20 66 29 <i>KNEESPACE: 34"</i>	class 125 cwt 194 lb cu ft 26	2,844 W 2,484 P  2,835 W 2,407 P	3,245 W 2,683 P  3,053 W 2,598 P



laminated  
tops only

3L-P saddle on walnut  
4L-P dark mahogany on walnut  
25M-P mahogany on walnut  
25C-P cherry on walnut

veneered  
tops only

3L-W saddle on walnut  
2KL-W sepia on walnut  
4L-W dark mahogany on walnut  
25M-W mahogany on walnut  
25C-W cherry on walnut

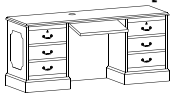
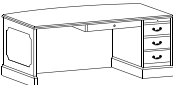
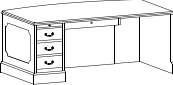
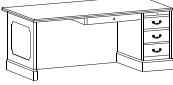
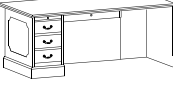
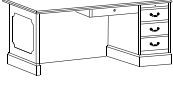
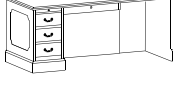
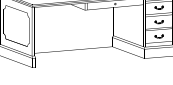

	model number	description	d w h	freight	list \$ zone 1	list \$ zone 2
 <p>[ QS ]</p>	<b>CR1966KB</b> - _ - _	kneespace credenza with keyboard box/file pedestal on each side <small>Quick Ship available in 2KL walnut veneer tops</small>	20 66 29 <small>KNEESPACE: 34"</small>	class 125 cwt 204 lb cu ft 26	<b>3,369 W</b> <b>2,848 P</b>	<b>3,638 W</b> <b>3,074 P</b>
	<b>CR1866KB</b> - _ - _	<small>ARTICULATING KEYBOARD HEIGHT ADJUSTMENT FROM 26.5 - 29"</small>			<b>3,195 W</b> <b>2,770 P</b>	<b>3,445 W</b> <b>2,991 P</b>
	<b>DBT1972R</b> - _ - _	bow top single pedestal desk right box/file pedestal includes center drawer arm slide	42 72 29 <small>APPROACH: 6"</small> <small>KNEESPACE: 32"</small>	class 125 cwt 255 lb cu ft 55	<b>5,324 W</b> <b>4,792 P</b>	<b>5,751 W</b> <b>5,174 P</b>
	<b>DBT1872R</b> - _ - _				<b>5,230 W</b> <b>4,775 P</b>	<b>5,627 W</b> <b>5,156 P</b>
	<b>DBT1972L</b> - _ - _	bow top single pedestal desk left box/file pedestal includes center drawer arm slide	42 72 29 <small>APPROACH: 6"</small> <small>KNEESPACE: 32"</small>	class 125 cwt 255 lb cu ft 55	<b>5,324 W</b> <b>4,792 P</b>	<b>5,751 W</b> <b>5,174 P</b>
	<b>DBT1872L</b> - _ - _				<b>5,230 W</b> <b>4,775 P</b>	<b>5,627 W</b> <b>5,156 P</b>
	<b>CFD1972R</b> - _ - _	single pedestal desk with conference overhang right box/file pedestal includes center drawer arm slide	36 72 29 <small>KNEESPACE: 32"</small>	class 125 cwt 225 lb cu ft 53	<b>3,643 W</b> <b>3,122 P</b>	<b>3,936 W</b> <b>3,358 P</b>
	<b>CFD1872R</b> - _ - _				<b>3,550 W</b> <b>3,097 P</b>	<b>3,816 W</b> <b>3,342 P</b>
	<b>CFD1972L</b> - _ - _	single pedestal desk with conference overhang left box/file pedestal includes center drawer arm slide	36 72 29 <small>KNEESPACE: 32"</small>	class 125 cwt 225 lb cu ft 53	<b>3,643 W</b> <b>3,122 P</b>	<b>3,936 W</b> <b>3,358 P</b>
	<b>CFD1872L</b> - _ - _				<b>3,550 W</b> <b>3,097 P</b>	<b>3,816 W</b> <b>3,342 P</b>
	<b>CFD1966R</b> - _ - _	single pedestal desk with conference overhang right box/file pedestal includes center drawer arm slide	36 66 29 <small>KNEESPACE: 26"</small>	class 125 cwt 200 lb cu ft 48	<b>3,573 W</b> <b>3,088 P</b>	<b>3,857 W</b> <b>3,342 P</b>
	<b>CFD1866R</b> - _ - _				<b>3,240 W</b> <b>2,836 P</b>	<b>3,499 W</b> <b>3,059 P</b>
	<b>CFD1966L</b> - _ - _	single pedestal desk with conference overhang left box/file pedestal includes center drawer arm slide	36 66 29 <small>KNEESPACE: 26"</small>	class 125 cwt 200 lb cu ft 48	<b>3,573 W</b> <b>3,088 P</b>	<b>3,857 W</b> <b>3,342 P</b>
	<b>CFD1866L</b> - _ - _				<b>3,240 W</b> <b>2,836 P</b>	<b>3,499 W</b> <b>3,059 P</b>
	<b>D1972R</b> - _ - _	single pedestal desk right box/file pedestal includes center drawer arm slide	36 72 29 <small>KNEESPACE: 32"</small>	class 125 cwt 235 lb cu ft 53	<b>3,643 W</b> <b>3,122 P</b>	<b>3,936 W</b> <b>3,358 P</b>
	<b>D1872R</b> - _ - _				<b>3,550 W</b> <b>3,097 P</b>	<b>3,816 W</b> <b>3,342 P</b>
	<b>D1972L</b> - _ - _	single pedestal desk left box/file pedestal includes center drawer arm slide	36 72 29 <small>KNEESPACE: 32"</small>	class 125 cwt 235 lb cu ft 53	<b>3,643 W</b> <b>3,122 P</b>	<b>3,936 W</b> <b>3,358 P</b>
	<b>D1872L</b> - _ - _				<b>3,550 W</b> <b>3,097 P</b>	<b>3,816 W</b> <b>3,342 P</b>

top

**P** laminate top  
**W** veneer top

edge







monticello/empire  
1900 series with molding

1900/1800 series  
1800 series without molding

wood top, veneer chassis, veneer drawer fronts  
laminate top, veneer chassis, veneer drawer fronts

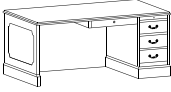

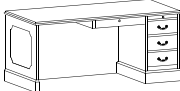
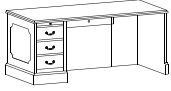
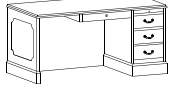
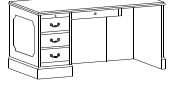
monticello/empire  
1900/1800

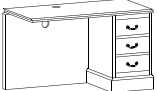





	model number	description	d w h	freight	list \$ zone 1	list \$ zone 2
	D1966R - _ - _ D1866R - _ - _	single pedestal desk right box/file pedestal includes center drawer arm slide	36 66 29 <small>KNEESPACE: 26"</small>	class 125 cwt 210 lb cu ft 48	3,573 W 3,088 P  3,240 W 2,836 P	3,857 W 3,342 P  3,499 W 3,059 P
	D1966L - _ - _ D1866L - _ - _	single pedestal desk left box/file pedestal includes center drawer arm slide	36 66 29 <small>KNEESPACE: 26"</small>	class 125 cwt 210 lb cu ft 48	3,573 W 3,088 P  3,240 W 2,836 P	3,857 W 3,342 P  3,499 W 3,059 P
	D196630R - _ - _ D186630R - _ - _	single pedestal desk right box/file pedestal includes center drawer arm slide	30 66 29 <small>KNEESPACE: 26"</small>	class 125 cwt 195 lb cu ft 40	3,227 W 2,425 P  3,079 W 2,354 P	3,485 W 2,618 P  3,327 W 2,544 P
	D196630L - _ - _ D186630L - _ - _	single pedestal desk left box/file pedestal includes center drawer arm slide	30 66 29 <small>KNEESPACE: 26"</small>	class 125 cwt 195 lb cu ft 40	3,227 W 2,425 P  3,079 W 2,354 P	3,485 W 2,618 P  3,327 W 2,544 P
	D1960R - _ - _ D1860R - _ - _	single pedestal desk right box/file pedestal includes center drawer arm slide	30 60 29 <small>KNEESPACE: 24"</small>	class 125 cwt 185 lb cu ft 37	3,102 W 2,680 P  2,809 W 2,466 P	3,357 W 2,895 P  3,020 W 2,663 P
	D1960L - _ - _ D1860L - _ - _	single pedestal desk left box/file pedestal includes center drawer arm slide	30 60 29 <small>KNEESPACE: 24"</small>	class 125 cwt 185 lb cu ft 37	3,102 W 2,680 P  2,809 W 2,466 P	3,357 W 2,895 P  3,020 W 2,663 P
	D1948R - _ - _ D1848R - _ - _	single pedestal desk right box/file pedestal arm slide	24 48 29 <small>KNEESPACE: 30"</small>	class 125 cwt 157 lb cu ft 24	2,036 W 1,744 P  1,951 W 1,656 P	2,199 W 1,884 P  2,106 W 1,791 P
	D1948L - _ - _ D1848L - _ - _	single pedestal desk left box/file pedestal arm slide	24 48 29 <small>KNEESPACE: 30"</small>	class 125 cwt 157 lb cu ft 24	2,036 W 1,744 P  1,951 W 1,656 P	2,199 W 1,884 P  2,106 W 1,791 P
	R1948R-EH - _ - _ R1848R-EH - _ - _	right return right box/file pedestal  <small>NOT INTENDED FOR CORNER UNITS</small>	24 48 29 <small>KNEESPACE: 32"</small>	class 125 cwt 165 lb cu ft 25	1,739 W 1,483 P  1,693 W 1,360 P	1,876 W 1,602 P  1,828 W 1,470 P

laminated  
tops only

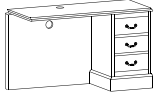
3L-P saddle on walnut  
4L-P dark mahogany on walnut  
25M-P mahogany on walnut  
25C-P cherry on walnut

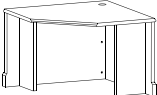
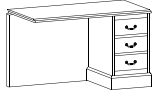
veneered  
tops only

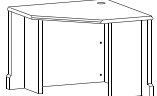
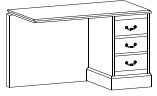
3L-W saddle on walnut  
2KL-W sepia on walnut  
4L-W dark mahogany on walnut  
25M-W mahogany on walnut  
25C-W cherry on walnut

	model number	description	d w h	freight	list \$ zone 1	list \$ zone 2
	R1948L-EH - _ - _	left return left box/file pedestal	24 48 29 <i>KNEESPACE: 32"</i>	class 125 cwt 165 lb cu ft 25	1,739 W 1,483 P	1,876 W 1,602 P
	R1848L-EH - _ - _	<i>NOT INTENDED FOR CORNER UNITS</i>			1,693 W 1,360 P	1,828 W 1,470 P
	R194820R-EH - _ - _	right return right box/file pedestal	20 48 29 <i>KNEESPACE: 32"</i>	class 125 cwt 160 lb cu ft 25	1,739 W 1,483 P	1,876 W 1,602 P
	R184820R-EH - _ - _	<i>FOR USE WITH D1960 AND D1860</i>			1,693 W 1,360 P	1,828 W 1,470 P
	R194820L-EH - _ - _	left return left box/file pedestal	20 48 29	class 125 cwt 160 lb cu ft 25	1,739 W 1,483 P	1,876 W 1,602 P
	R184820L-EH - _ - _	<i>FOR USE WITH D1960 AND D1860</i>			1,693 W 1,360 P	1,828 W 1,470 P
	CU1942 - _ - _	corner unit	42 42 29 <i>KNEESPACE: 26"</i>	class 125 cwt 188 lb cu ft 8	2,110 W 1,802 P	2,279 W 1,947 P
	CU1842 - _ - _				2,044 W 1,765 P	2,206 W 1,876 P
	R1924R - _ - _	right return right box/file pedestal	24 48 29	class 125 cwt 165 lb cu ft 25	1,739 W 1,483 P	1,876 W 1,602 P
	R1824R - _ - _	<i>FOR USE WITH 42" CORNER UNITS</i>			1,693 W 1,360 P	1,828 W 1,470 P
	R1924L - _ - _	left return left box/file pedestal	24 48 29	class 125 cwt 165 lb cu ft 25	1,739 W 1,483 P	1,876 W 1,602 P
	R1824L - _ - _	<i>FOR USE WITH 42" CORNER UNITS</i>			1,693 W 1,360 P	1,828 W 1,470 P
	CU1938 - _ - _	corner unit	38 38 29 <i>KNEESPACE: 26"</i>	class 125 cwt 170 lb cu ft 8	1,908 W 1,629 P	2,056 W 1,762 P
	CU1838 - _ - _	<i>FOR USE WITH 2FD1937 AND HW1937 OR 2FD1837 AND HW1837</i>			1,851 W 1,572 P	1,998 W 1,696 P
	R1920R - _ - _	right return right box/file pedestal returns	20 48 29	class 125 cwt 160 lb cu ft 25	1,739 W 1,483 P	1,876 W 1,602 P
	R1820R - _ - _	<i>FOR USE WITH 38" CORNER UNITS</i>			1,693 W 1,360 P	1,828 W 1,470 P
	R1920L - _ - _	left return left box/file pedestal returns	20 48 29	class 125 cwt 160 lb cu ft 25	1,739 W 1,483 P	1,876 W 1,602 P
	R1820L - _ - _	<i>FOR USE WITH 38" CORNER UNITS</i>			1,693 W 1,360 P	1,828 W 1,470 P

top

P laminate top  
W veneer top

edge



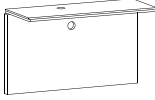
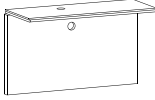
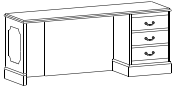
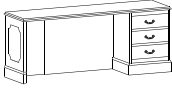
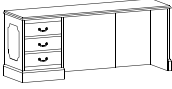
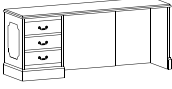
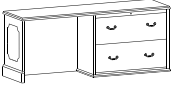
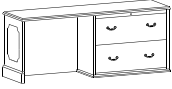
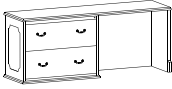

	model number	description	d	w	h	freight	list \$ zone 1	list \$ zone 2
	<b>B1948-EH</b> - _ - _	bridge open kneespace	20	48	29	class 125 cwt 65 lb cu ft 3	<b>870 W</b> <b>774 P</b>	<b>939 W</b> <b>837 P</b>
	<b>B1848-EH</b> - _ - _						<b>833 W</b> <b>690 P</b>	<b>900 W</b> <b>743 P</b>
	<b>B194824-EH</b> - _ - _	bridge open kneespace	24	48	29	class 125 cwt 65 lb cu ft 3	<b>986 W</b> <b>796 P</b>	<b>1,065 W</b> <b>859 P</b>
	<b>B184824-EH</b> - _ - _						<b>845 W</b> <b>711 P</b>	<b>912 W</b> <b>768 P</b>
	<b>C1972R</b> - _ - _	single pedestal credenza right box/file pedestal	20	72	29	class 125 cwt 190 lb cu ft 28 <i>KNEESPACE: 32"</i>	<b>2,912 W</b> <b>2,509 P</b>	<b>3,133 W</b> <b>2,710 P</b>
	<b>C1872R</b> - _ - _						<b>2,442 W</b> <b>1,950 P</b>	<b>2,637 W</b> <b>2,105 P</b>
	<b>C197224R</b> - _ - _	single pedestal credenza right box/file pedestal	24	72	29	class 125 cwt 190 lb cu ft 28 <i>KNEESPACE: 32"</i>	<b>3,251 W</b> <b>2,795 P</b>	<b>3,510 W</b> <b>3,019 P</b>
	<b>C187224R</b> - _ - _						<b>2,494 W</b> <b>2,236 P</b>	<b>2,694 W</b> <b>2,415 P</b>
	<b>C1972L</b> - _ - _	single pedestal credenza left box/file pedestal	20	72	29	class 125 cwt 190 lb cu ft 28 <i>KNEESPACE: 32"</i>	<b>2,912 W</b> <b>2,509 P</b>	<b>3,133 W</b> <b>2,710 P</b>
	<b>C1872L</b> - _ - _						<b>2,442 W</b> <b>1,950 P</b>	<b>2,637 W</b> <b>2,105 P</b>
	<b>C197224L</b> - _ - _	single pedestal credenza left box/file pedestal	24	72	29	class 125 cwt 190 lb cu ft 28 <i>KNEESPACE: 32"</i>	<b>3,251 W</b> <b>2,795 P</b>	<b>3,510 W</b> <b>3,019 P</b>
	<b>C187224L</b> - _ - _						<b>2,494 W</b> <b>2,236 P</b>	<b>2,694 W</b> <b>2,415 P</b>
	<b>C1972R-2F</b> - _ - _	single pedestal credenza right lateral file pedestal	20	72	29	class 125 cwt 240 lb cu ft 28 <i>KNEESPACE: 15"</i>	<b>3,311 W</b> <b>2,916 P</b>	<b>3,574 W</b> <b>3,148 P</b>
	<b>C1872R-2F</b> - _ - _						<b>2,850 W</b> <b>2,455 P</b>	<b>3,046 W</b> <b>2,651 P</b>
	<b>C197224R-2F</b> - _ - _	single pedestal credenza right lateral file pedestal	24	72	29	class 125 cwt 240 lb cu ft 28 <i>KNEESPACE: 15"</i>	<b>3,650 W</b> <b>3,203 P</b>	<b>3,941 W</b> <b>3,459 P</b>
	<b>C187224R-2F</b> - _ - _						<b>3,189 W</b> <b>2,741 P</b>	<b>3,444 W</b> <b>2,961 P</b>
	<b>C1972L-2F</b> - _ - _	single pedestal credenza left lateral file pedestal	20	72	29	class 125 cwt 240 lb cu ft 28 <i>KNEESPACE: 15"</i>	<b>3,311 W</b> <b>2,916 P</b>	<b>3,574 W</b> <b>3,148 P</b>
	<b>C1872L-2F</b> - _ - _						<b>2,850 W</b> <b>2,455 P</b>	<b>3,046 W</b> <b>2,651 P</b>

**laminated**  
tops only

**3L-P** saddle on walnut  
**4L-P** dark mahogany on walnut  
**25M-P** mahogany on walnut  
**25C-P** cherry on walnut

**veneered**  
tops only

**3L-W** saddle on walnut  
**2KL-W** sepia on walnut  
**4L-W** dark mahogany on walnut  
**25M-W** mahogany on walnut  
**25C-W** cherry on walnut

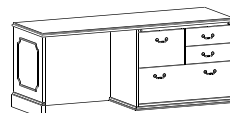

We offer a 4D configuration option (as shown). For information please call customer service.

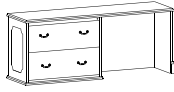
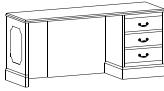
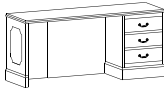
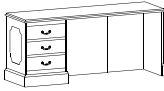
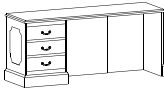
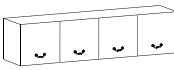
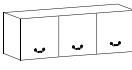
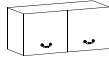
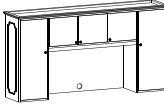
	model number	description	d w h	freight	list \$ zone 1	list \$ zone 2
	C197224L-2F - _ -	single pedestal credenza left lateral file pedestal	24 72 29 <i>KNEESPACE: 15"</i>	class 125 cwt 240 lb cu ft 28	3,650 W 3,203 P	3,941 W 3,459 P
	C187224L-2F - _ -				3,189 W 2,741 P	3,444 W 2,961 P
	C1966R - _ - _	single pedestal credenza right box/file pedestal	20 66 29 <i>KNEESPACE: 26"</i>	class 125 cwt 180 lb cu ft 26	2,407 W 2,044 P	2,598 W 2,210 P
	C1866R - _ - _				2,205 W 1,814 P	2,564 W 1,960 P
	C196624R - _ - _	single pedestal credenza right box/file pedestal	24 66 29 <i>KNEESPACE: 26"</i>	class 125 cwt 180 lb cu ft 26	2,863 W 2,410 P	3,093 W 2,603 P
	C186624R - _ - _				2,661 W 2,180 P	2,874 W 2,354 P
	C1966L - _ - _	single pedestal credenza left box/file pedestal	20 66 29 <i>KNEESPACE: 26"</i>	class 125 cwt 180 lb cu ft 26	2,407 W 2,044 P	2,598 W 2,210 P
	C1866L - _ - _				2,205 W 1,814 P	2,564 W 1,960 P
	C196624L - _ - _	single pedestal credenza left box/file pedestal	24 66 29 <i>KNEESPACE: 26"</i>	class 125 cwt 180 lb cu ft 26	2,863 W 2,410 P	3,093 W 2,603 P
	C186624L - _ - _				2,661 W 2,180 P	2,874 W 2,354 P
	WH1966 - _ - _	66" wide wall hung overhead unit four hinged doors	16 66 16	class 125 cwt 110 lb cu ft 13	1,792	1,935
	WH1866 - _ - _				1,792	1,935
	WH1948 - _ - _	48" wide wall hung overhead unit three hinged doors	16 48 16	class 125 cwt 90 lb cu ft 10	1,541	1,665
	WH1848 - _ - _				1,541	1,665
	WH1936 - _ - _	36" wide wall hung overhead unit two hinged doors	16 36 16	class 125 cwt 75 lb cu ft 7	1,010	1,090
	WH1836 - _ - _				1,010	1,090
	FH1984 - _ - _	84" wide overhead storage unit two full hinged doors with 2 adjustable shelves	17.5 82.5 43.25 <i>OPENING: 25.63"</i>	class 125 cwt 260 lb cu ft 40	4,248	4,588
	FH1884 - _ - _	three half hinged doors wire management grommet			3,693	3,989
		ADDITIONAL SHELVES (EACH) \$92 SOLID WOOD SHELVES (EACH) \$28				

top

**P** laminate top  
**W** veneer top

for **tackboard options**, see pages 522-523  
for standard fabrics available on tackboards, see page 504

edge











	model number	description	d w h	freight	list \$ zone 1	list \$ zone 2
	FH1972 - _ - _	72" wide overhead storage unit two full hinged doors with 2 adjustable shelves	17.5 70.75 43.25 <small>OPENING: 25.63"</small>	class 125 cwt 260 lb cu ft 40	3,498	3,999
	FH1872 - _ - _	two half hinged doors wire management grommet			2,943	3,843
		<small>ADDITIONAL SHELVES (EACH) \$92 SOLID WOOD SHELVES (EACH) \$28</small>				
	FH1966 - _ - _	66" wide overhead storage unit two full hinged doors with 2 adjustable shelves	17.5 65 43.25 <small>OPENING: 25.63"</small>	class 125 cwt 245 lb cu ft 38	2,978	3,865
	FH1866 - _ - _	two half hinged doors wire management grommet			2,834	3,706
	OU1984 - _ - _	84" wide overhead storage unit five hinged doors	17.5 82.5 43.25 <small>OPENING: 25.63"</small>	class 125 cwt 190 lb cu ft 40	3,741	4,040
	OU1884 - _ - _	three wire management grommets			3,597	3,883
	OU1972 - _ - _	72" wide overhead storage unit four hinged doors	17.5 70.75 43.25 <small>OPENING: 25.63"</small>	class 125 cwt 190 lb cu ft 40	2,991	3,230
	OU1872 - _ - _	three wire management grommets			2,845	3,073
	[ QS ] OU1966 - _ - _	66" wide overhead storage unit four hinged doors	17.5 65 43.25 <small>OPENING: 25.63"</small>	class 125 cwt 180 lb cu ft 38	2,740	2,964
	OU1866 - _ - _	three wire management grommets			2,493	2,941
		<small>Quick Ship available in 2KL walnut veneer tops</small>				
	OU1948 - _ - _	48" wide overhead storage unit three hinged doors	17.25 47 43.25 <small>OPENING: 25.63"</small>	class 125 cwt 150 lb cu ft 26	2,222	2,392
	OU1848 - _ - _	three wire management grommets			2,070	2,240
	OU1936 - _ - _	36" wide overhead storage unit two hinged doors	17.5 35 43.25 <small>OPENING: 25.63"</small>	class 125 cwt 115 lb cu ft 19	1,964	2,117
	OU1836 - _ - _	two wire management grommets			1,812	1,965
	OD1984 - _ - _	84" wide overhead storage unit with open center	17.5 82.5 43.25 <small>OPENING: 25.63"</small>	class 125 cwt 185 lb cu ft 40	3,402	3,675
	OD1884 - _ - _	one hinged door on each end three wire management grommets			3,303	3,566
	OD1972 - _ - _	72" wide overhead storage unit with open center	17.5 70.8 43.25 <small>OPENING: 25.63"</small>	class 125 cwt 185 lb cu ft 40	2,650	2,862
	OD1872 - _ - _	one hinged door on each end three wire management grommets			2,552	2,757

**laminate**  
tops only

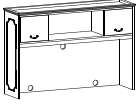
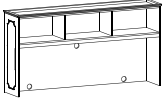
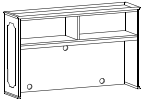
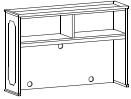
- 3L-P saddle on walnut
- 4L-P dark mahogany on walnut
- 25M-P mahogany on walnut
- 25C-P cherry on walnut

**veneer**  
tops only

- 3L-W saddle on walnut
- 2KL-W sepia on walnut
- 4L-W dark mahogany on walnut
- 25M-W mahogany on walnut
- 25C-W cherry on walnut

	model number	description	d w h	freight	list \$ zone 1	list \$ zone 2
	OD1966 - _ - _	66" wide storage unit with open center one hinged door on each end three wire management grommets	17.5 64.3 43.25 <small>OPENING: 25.63"</small>	class 125 cwt 175 lb cu ft 38	2,391	2,583
	OD1866 - _ - _				2,287	2,470
	OO1984 - _ - _	84" wide open overhead storage unit with open center three wire management grommets	17.5 82.5 43.25 <small>OPENING: 25.63"</small>	class 125 cwt 180 lb cu ft 40	2,893	3,124
	OO1884 - _ - _				2,734	2,952
	OO1972 - _ - _	72" wide open overhead storage unit with open center three wire management grommets	17.5 70.8 43.25 <small>OPENING: 25.63"</small>	class 125 cwt 180 lb cu ft 40	2,144	2,314
	OO1872 - _ - _				2,006	2,166
	OO1966 - _ - _	66" wide open overhead storage unit with open center three wire management grommets	17.5 64.3 43.25 <small>OPENING: 25.63"</small>	class 125 cwt 170 lb cu ft 38	2,133	2,169
	OO1866 - _ - _				1,993	2,154
	USU84 - _	underside paper storage for use with 84" overhead storage units does not prevent the use of task lights or tackboards  <small>FACTORY INSTALLED</small>	15.5 82 4	class cwt lb cu ft	512	554
	USU72 - _	underside paper storage for use with 72" overhead storage units does not prevent the use of task lights or tackboards  <small>FACTORY INSTALLED</small>	15.5 70 4	class cwt lb cu ft	498 498	536 536
	USU66 - _	underside paper storage for use with 66" overhead storage units does not prevent the use of task lights or tackboards  <small>FACTORY INSTALLED</small>	15.5 64 4	class cwt lb cu ft	498 498	536 536
	USU48 - _	underside paper storage for use with 48" overhead storage units does not prevent the use of task lights or tackboards  <small>FACTORY INSTALLED</small>	15.5 46 4	class cwt lb cu ft	292 292	315 315
	USU36 - _	underside paper storage for use with 36" overhead storage units does not prevent the use of task lights or tackboards  <small>FACTORY INSTALLED</small>	15.5 34 4	class cwt lb cu ft	292 292	315 315

top  
P laminate top  
W veneer top

edge



monticello/empire  
1900 series with molding

1900/1800 series  
1800 series without molding

wood top, veneer chassis, veneer drawer fronts  
laminated top, veneer chassis, veneer drawer fronts



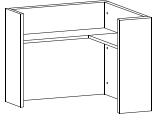
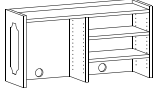
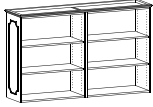
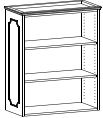
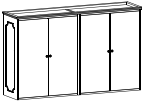
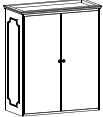
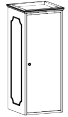
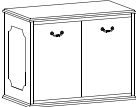
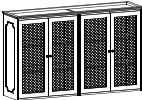

monticello/empire  
1900/1800

	model number	description	d	w	h	freight	list \$ zone 1	list \$ zone 2
	CUH - _ - _	corner hutch  <i>FOR USE WITH CU1938 OR CU1838 (MUST BE ORDERED SEPARATELY)</i>	38	38	32	class 85 kd cwt 105 lb cu ft 20	1,812	1,994
	H1948 - _ - _ H1848 - _ - _	hutch with wire management grommets with two adjustable shelves  <i>CAN BE USED WITH A 48" DESK OR COMPUTER PRINTER STAND ADDITIONAL SHELVES (EACH) \$92 SOLID WOOD SHELVES (EACH) \$28</i>	14	47	24	class 125 cwt 82 lb cu ft 12	1,122 1,084	1,215 1,170
	HO1971 - _ - _ HO1871 - _ - _	hutch two adjustable shelves each side  <i>TO SET ON 4HW1974, 4FD1974, 4HW1874 OR 4FD1874 ADDITIONAL SHELVES (EACH) \$92 SOLID WOOD SHELVES (EACH) \$28</i>	16.5	71	43.25	class 125 cwt 200 lb cu ft 34	3,129 2,879	3,561 3,296
	HO1936 - _ - _ HO1836 - _ - _	hutch two adjustable shelves each side  <i>TO SET ON HW1937, 2FD1937, HW1837 OR 2FD1837 ADDITIONAL SHELVES (EACH) \$92 SOLID WOOD SHELVES (EACH) \$28</i>	16.5	36	43.25	class 125 cwt 100 lb cu ft 21	1,549 1,439	1,763 1,647
	HW1971 - _ - _ HW1871 - _ - _	hinged door hutch wood doors two adjustable shelves  <i>TO SET ON 4HW1974, 4FD1974, 4HW1874 OR 4FD1874 ADDITIONAL SHELVES (EACH) \$92 SOLID WOOD SHELVES (EACH) \$28</i>	17	71	43.25	class 125 cwt 220 lb cu ft 34	3,704 3,538	3,999 3,823
	HW1936 - _ - _ HW1836 - _ - _	hinged door cabinet wood doors two adjustable shelves  <i>TO SET ON HW1937, 2FD1937, HW1837 OR 2FD1837 ADDITIONAL SHELVES (EACH) \$92 SOLID WOOD SHELVES (EACH) \$28</i>	17	36	43.25	class 125 cwt 115 lb cu ft 21	1,980 1,814	2,138 1,958
	HW1918R - _ - _ HW1918L - _ - _ HW1818R - _ - _ HW1818L - _ - _	hinged door cabinet wood doors two adjustable shelves  <i>ADDITIONAL SHELVES (EACH) \$92 SOLID WOOD SHELVES (EACH) \$28</i>	17.5	18	43.25	class 125 cwt 125 lb cu ft 11	1,742 1,584	1,868 1,780
	HW1937 - _ - _ HW1837 - _ - _	hinged door cabinet wood doors one adjustable shelf (bracket base unit not available)  <i>ADDITIONAL SHELVES (EACH) \$92 SOLID WOOD SHELVES (EACH) \$28</i>	20	37	29	class 125 cwt 160 lb cu ft 16	1,908 W 1,618 P 1,745 W 1,454 P	2,056 W 1,746 P 1,883 W 1,570 P
	HG1971 - _ - _ HG1871 - _ - _	hinged door cabinets wire grill doors two adjustable shelves in each side  <i>TO SET ON 4HW1974, 4FD1974, 4HW1874 OR 4FD1874 ADDITIONAL SHELVES (EACH) \$92 SOLID WOOD SHELVES (EACH) \$28</i>	17	71	43.25	class 125 cwt 220 lb cu ft 34	4,589 4,274	4,957 4,656

laminated tops only	3L-P	saddle on walnut
	4L-P	dark mahogany on walnut
	25M-P	mahogany on walnut
	25C-P	cherry on walnut
veneered tops only	3L-W	saddle on walnut
	2KL-W	sepia on walnut
	4L-W	dark mahogany on walnut
	25M-W	mahogany on walnut
	25C-W	cherry on walnut

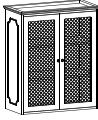

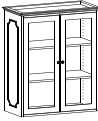
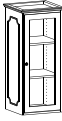
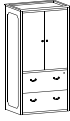
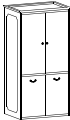
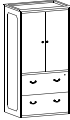
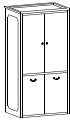
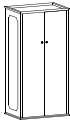
	model number	description	d	w	h	freight	list \$ zone 1	list \$ zone 2
	HG1936 - _ - _	hinged door cabinet wire grill doors two adjustable shelves	17	36	43.25	class 125 cwt 115 lb cu ft 34	2,402	2,593
	HG1836 - _ - _	TO SET ON HW1937, 2FD1937, HW1837 OR 2FD1837 ADDITIONAL SHELVES (EACH) \$92 SOLID WOOD SHELVES (EACH) \$28					2,230	2,408
	HD1971 - _ - _	hinged door cabinets glass doors two adjustable shelves in each side	17	71	43.25	class 125 cwt 220 lb cu ft 34	3,874	4,183
	HD1871 - _ - _	TO SET ON 4HW1974, 4FD1974, 4HW1874 OR 4FD1874 ADDITIONAL SHELVES (EACH) \$92 SOLID WOOD SHELVES (EACH) \$28					3,709	4,006
	HD1936 - _ - _	hinged door cabinet glass doors two adjustable shelves	17	36	43.25	class 125 cwt 115 lb cu ft 21	2,061	2,225
	HD1836 - _ - _	TO SET ON HW1937, 2FD1937, HW1837 OR 2FD1837 ADDITIONAL SHELVES (EACH) \$92 SOLID WOOD SHELVES (EACH) \$28					1,899	2,132
	HD1918R - _ - _	hinged door cabinet glass doors two adjustable shelves	17.5	18	43.25	class 125 cwt 115 lb cu ft 21	1,826	2,021
	HD1918L - _ - _							
	HD1818R - _ - _	R=RIGHT SIDE HINGE, LEFT KNOB L=LEFT SIDE HINGE, RIGHT KNOB					1,668	1,864
	HD1818L - _ - _	ADDITIONAL SHELVES (EACH) \$92 SOLID WOOD SHELVES (EACH) \$28						
	AV19722F - _ - _	tv cabinet pocket doors with pull-out swivel tv tray upper lateral file below	24	36	72	class 125 cwt 340 lb cu ft 43	5,957	6,433
	AV18722F - _ - _						5,957	6,433
	AV1972HW - _ - _	tv cabinet pocket doors with pull-out swivel tv tray upper hinged doors below	24	36	72	class 125 cwt 270 lb cu ft 43	5,754	6,217
	AV1872HW - _ - _	ADDITIONAL SHELVES (EACH) \$92 SOLID WOOD SHELVES (EACH) \$28					5,754	6,217
	HW19722F - _ - _	storage cabinet hinged doors with 2 adjustable shelves upper lateral file below	24	36	72	class 125 cwt 320 lb cu ft 43	5,199	5,615
	HW18722F - _ - _	ADDITIONAL SHELVES (EACH) \$92 SOLID WOOD SHELVES (EACH) \$28					5,199	5,615
	HW1972HW - _ - _	storage cabinet hinged doors with 2 adjustable shelves upper and 1 adjustable lower shelf	24	36	72	class 125 cwt 270 lb cu ft 43	4,980	5,384
	HW1872HW - _ - _	ADDITIONAL SHELVES (EACH) \$92 SOLID WOOD SHELVES (EACH) \$28					4,980	5,384
	WD1972 - _ - _	wardrobe two hinged doors right side coat storage left side 3 adjustable shelves storage shelf above	24	36	72	class 125 cwt 285 lb cu ft 42	4,276	4,538
	WD1872 - _ - _	INSIDE DIMENSIONS: 21D x 33W x 69H ADDITIONAL SHELVES (EACH) \$92 SOLID WOOD SHELVES (EACH) \$28					3,728	4,027

top

P laminate top  
W veneer top







edge



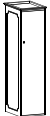

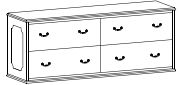
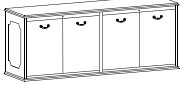
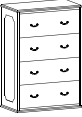

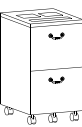



monticello/empire | 1900/1800 series | wood top, veneer chassis, veneer drawer fronts  
 1900 series with molding | 1800 series without molding | laminate top, veneer chassis, veneer drawer fronts



monticello/empire  
1900/1800

	model number	description	d	w	h	freight	list \$ zone 1	list \$ zone 2
	<b>WD1972R-18</b> - __ - __ <b>WD1972L-18</b> - __ - __  <b>WD1872R-18</b> - __ - __ <b>WD1872L-18</b> - __ - __	wardrobe/coat storage (R) right hinge/knob left (L) left hinge/knob right  <i>ADDITIONAL SHELVES (EACH) \$92</i> <i>SOLID WOOD SHELVES (EACH) \$28</i>	24	18	72	class 125 cwt 170 lb cu ft 23	<b>3,170</b>	<b>3,425</b>  <b>2,938</b>
	<b>4HW1974D-36</b> - __ - __ - - - <b>4HW1874D-36</b> - __ - __ - - -	servicing height credenza two sets of hinged doors with one adjustable shelf on each side two drawers above (bracket base not available)  <i>ADDITIONAL SHELVES (EACH) \$92</i> <i>SOLID WOOD SHELVES (EACH) \$28</i>	20	73	36	class 125 cwt 405 lb cu ft 37	<b>4,473 W</b> <b>4,041 P</b>	<b>4,804 W</b> <b>4,339 P</b>  <b>4,479 W</b> <b>4,012 P</b>
	<b>4FD1974</b> - __ - __  <b>4FD1874</b> - __ - __	lateral file/four drawers two drawers side by side under common top (bracket base not available)	20	73	29	class 125 cwt 310 lb cu ft 30	<b>4,215 W</b> <b>3,769 P</b>	<b>4,539 W</b> <b>4,072 P</b>  <b>3,992 W</b> <b>3,511 P</b>
	<b>4HW1974</b> - __ - __  <b>4HW1874</b> - __ - __	2-hinged door cabinets under common top with one adjustable shelf each (bracket base not available)  <i>INSIDE DIMENSIONS EACH CABINET: 19"D x 34.5"W x 25.8"H</i> <i>ADDITIONAL SHELVES (EACH) \$92</i> <i>SOLID WOOD SHELVES (EACH) \$28</i>	20	73	29	class 125 cwt 255 lb cu ft 32	<b>3,817 W</b> <b>3,373 P</b>	<b>4,114 W</b> <b>3,642 P</b>  <b>3,492 W</b> <b>3,046 P</b>
	<b>4FD1937</b> - __ - __  <b>4FD1837</b> - __ - __	lateral file with four drawers standard anti-tip locking (bracket base not available)	20	37	54	class 125 cwt 265 lb cu ft 25	<b>4,036 W</b> <b>3,467 P</b>	<b>4,417 W</b> <b>3,746 P</b>  <b>4,166 W</b> <b>3,476 P</b>
	<b>3FD1937</b> - __ - __  <b>3FD1837</b> - __ - __	lateral file with three drawers standard anti-tip locking (bracket base not available)	20	37	41	class 125 cwt 225 lb cu ft 25	<b>3,109 W</b> <b>2,838 P</b>	<b>3,358 W</b> <b>3,065 P</b>  <b>2,879 W</b> <b>2,656 P</b>
	[ QS ] <b>2FD1937</b> - __ - __ Quick Ship available in 2KL walnut veneer tops  <b>2FD1837</b> - __ - __	lateral file with two drawers standard with anti-tip locking system (bracket base not available)	20	37	29	class 125 cwt 160 lb cu ft 16	<b>2,312 W</b> <b>2,011 P</b>	<b>2,496 W</b> <b>2,171 P</b>  <b>1,936 W</b> <b>1,645 P</b>
	<b>MP192F</b> - __ - __  <b>MP182F</b> - __ - __	mobile pedestal file/file drawers with locking casters for use under any 29" surface black tray top	18.9	16.6	27.3	class 125 cwt 75 lb cu ft 6	<b>1,217</b>	<b>1,315</b>  <b>1,315</b>
	<b>MP193D</b> - __ - __  <b>MP183D</b> - __ - __	mobile pedestal box/box/file drawers with locking casters for use under any 29" surface black tray top	18.9	16.6	27.3	class 125 cwt 75 lb cu ft 6	<b>1,232</b>	<b>1,331</b>  <b>1,331</b>

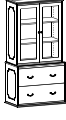
laminate tops only	<b>3L-P</b>	saddle on walnut
	<b>4L-P</b>	dark mahogany on walnut
	<b>25M-P</b>	mahogany on walnut
	<b>25C-P</b>	cherry on walnut
veneer tops only	<b>3L-W</b>	saddle on walnut
	<b>2KL-W</b>	sepia on walnut
	<b>4L-W</b>	dark mahogany on walnut
	<b>25M-W</b>	mahogany on walnut
	<b>25C-W</b>	cherry on walnut

	model number	description	d	w	h	freight	list \$ zone 1	list \$ zone 2
	<b>HWCR1972D</b> - __ - __	hutch and credenza hutch with four hinged doors and four adjustable shelves credenza has box/file on each side of hinged door cabinet with adjustable shelf <i>CREDENZA: 20"D x 72"W x 29"H SHIPS AS TWO PIECES</i> ADDITIONAL SHELVES (EACH) \$92 SOLID WOOD SHELVES (EACH) \$28	17	71	72.5	class 125 cwt 535 lb cu ft 68	<b>7,089 W</b> <b>6,644 P</b>	<b>7,655 W</b> <b>7,177 P</b>
	<b>HWCR1872D</b> - __ - __	credenza has box/file on each side of hinged door cabinet with adjustable shelf <i>CREDENZA: 20"D x 72"W x 29"H SHIPS AS TWO PIECES</i> ADDITIONAL SHELVES (EACH) \$92 SOLID WOOD SHELVES (EACH) \$28					<b>6,785 W</b> <b>6,579 P</b>	<b>7,319 W</b> <b>6,734 P</b>
	<b>HW2FD1937</b> - __ - __	hutch and lateral file wood doors and two adjustable shelves two drawer lateral file with standard anti-tip locking system	20	37	72.5	class 125 cwt 300 lb cu ft 37	<b>4,292 W</b> <b>3,990 P</b>	<b>4,635 W</b> <b>4,306 P</b>
	<b>HW2FD1837</b> - __ - __	LATERAL FILE 20x37x29 SHIPS AS TWO PIECES ADDITIONAL SHELVES (EACH) \$92 SOLID WOOD SHELVES (EACH) \$28					<b>3,751 W</b> <b>3,459 P</b>	<b>4,046 W</b> <b>3,735 P</b>
	<b>HWHW1937</b> - __ - __ - __ - __	hutch and hinged door cabinet wood doors and two adjustable shelves hinged wood door cabinet has one adjustable shelf	20	37	72.5	class 125 cwt 300 lb cu ft 37	<b>3,888 W</b> <b>3,598 P</b>	<b>4,193 W</b> <b>3,883 P</b>
	<b>HWHW1837</b> - __ - __ - __ - __	SHIPS AS TWO PIECES ADDITIONAL SHELVES (EACH) \$92 SOLID WOOD SHELVES (EACH) \$28					<b>3,559 W</b> <b>3,267 P</b>	<b>3,841 W</b> <b>3,529 P</b>
	<b>HGCR1972D</b> - __ - __	hutch and credenza hutch with four hinged wire grill doors and four adjustable shelves credenza has box/file on each side of hinge door cabinet with adjustable shelf <i>CREDENZA: 20"D x 72"W x 29"H SHIPS AS TWO PIECES</i> ADDITIONAL SHELVES (EACH) \$92 SOLID WOOD SHELVES (EACH) \$28	17	71	72.5	class 125 cwt 535 lb cu ft 68	<b>7,974 W</b> <b>7,530 P</b>	<b>8,612 W</b> <b>8,133 P</b>
	<b>HGCR1872D</b> - __ - __	credenza has box/file on each side of hinge door cabinet with adjustable shelf <i>CREDENZA: 20"D x 72"W x 29"H SHIPS AS TWO PIECES</i> ADDITIONAL SHELVES (EACH) \$92 SOLID WOOD SHELVES (EACH) \$28					<b>7,519 W</b> <b>7,091 P</b>	<b>8,153 W</b> <b>7,567 P</b>
	<b>HG2FD1937</b> - __ - __ - __ - __	hutch and lateral file hinged wire grill doors and two adjustable shelves two drawer lateral file with standard no-tip locking system	20	37	72.5	class 125 cwt 300 lb cu ft 37	<b>4,714 W</b> <b>4,410 P</b>	<b>5,090 W</b> <b>4,763 P</b>
	<b>HG2FD1837</b> - __ - __ - __ - __	SHIPS AS TWO PIECES ADDITIONAL SHELVES (EACH) \$92 SOLID WOOD SHELVES (EACH) \$28					<b>4,165 W</b> <b>3,874 P</b>	<b>4,493 W</b> <b>4,185 P</b>
	<b>HGHW1937</b> - __ - __ - __ - __	hutch with hinged door cabinet hutch with hinged wire grill doors, two adjustable shelves hinged wood door cabinet has one adjustable shelf	20	37	72.5	class 125 cwt 300 lb cu ft 37	<b>4,308 W</b> <b>4,020 P</b>	<b>4,649 W</b> <b>4,340 P</b>
	<b>HGHW1837</b> - __ - __ - __ - __	SHIPS AS TWO PIECES ADDITIONAL SHELVES (EACH) \$92 SOLID WOOD SHELVES (EACH) \$28					<b>3,940 W</b> <b>3,684 P</b>	<b>4,252 W</b> <b>3,979 P</b>
	<b>HDCR1972D</b> - __ - __	hutch and credenza hutch with four glass hinged doors and four adjustable shelves credenza has box/file on each side of hinged door cabinet with adjustable shelf <i>CREDENZA: 20"D x 72"W x 29"H SHIPS AS TWO PIECES</i> ADDITIONAL SHELVES (EACH) \$92 SOLID WOOD SHELVES (EACH) \$28	17	71	72.5	class 125 cwt 535 lb cu ft 68	<b>7,258 W</b> <b>6,814 P</b>	<b>7,839 W</b> <b>7,358 P</b>
	<b>HDCR1872D</b> - __ - __	credenza has box/file on each side of hinged door cabinet with adjustable shelf <i>CREDENZA: 20"D x 72"W x 29"H SHIPS AS TWO PIECES</i> ADDITIONAL SHELVES (EACH) \$92 SOLID WOOD SHELVES (EACH) \$28					<b>6,953 W</b> <b>6,526 P</b>	<b>7,503 W</b> <b>6,918 P</b>
	<b>HD2FD1937</b> - __ - __ - __ - __	hutch and lateral file hutch with hinged glass doors and two adjustable shelves two drawer lateral file with standard no-tip locking system	20	37	72.5	class 125 cwt 320 lb cu ft 37	<b>4,373 W</b> <b>4,072 P</b>	<b>4,721 W</b> <b>4,394 P</b>
	<b>HD2FD1837</b> - __ - __ - __ - __	SHIPS AS TWO PIECES ADDITIONAL SHELVES (EACH) \$92 SOLID WOOD SHELVES (EACH) \$28					<b>3,836 W</b> <b>3,545 P</b>	<b>4,217 W</b> <b>3,908 P</b>
	<b>HDHW1937</b> - __ - __ - __ - __	hutch and hinged door cabinet hutch with hinged glass doors and two adjustable shelves hinged wood door cabinet has one adjustable shelf	20	37	72.5	class 125 cwt 300 lb cu ft 37	<b>3,970 W</b> <b>3,678 P</b>	<b>4,261 W</b> <b>3,932 P</b>
	<b>HDHW1837</b> - __ - __ - __ - __	SHIPS AS TWO PIECES ADDITIONAL SHELVES (EACH) \$92 SOLID WOOD SHELVES (EACH) \$28					<b>3,609 W</b> <b>3,353 P</b>	<b>3,733 W</b> <b>3,423 P</b>

top

**P** laminate top  
**W** veneer top

edge





	model number	description	d	w	h	freight	list \$ zone 1	list \$ zone 2
	<b>HO2FD1937</b> - _ - _	open hutch and lateral file two adjustable shelves two drawer lateral file with standard no-tip locking system	20	37	72.5	class 125 cwt 300 lb cu ft 37	<b>3,862 W</b> <b>3,558 P</b>	<b>4,261 W</b> <b>3,932 P</b>
	<b>HO2FD1837</b> - _ - _	<i>SHIPS AS TWO PIECES</i> ADDITIONAL SHELVES (EACH) \$92 SOLID WOOD SHELVES (EACH) \$28					<b>3,375 W</b> <b>3,084 P</b>	<b>3,733 W</b> <b>3,423 P</b>
	<b>HOHW1937</b> - _ - _	open hutch and hinged door cabinet two adjustable shelves hinged wood door cabinet has one adjustable shelf	20	37	72.5	class 125 cwt 300 lb cu ft 37	<b>3,457 W</b> <b>3,165 P</b>	<b>3,818 W</b> <b>3,509 P</b>
	<b>HOHW1837</b> - _ - _	<i>SHIPS AS TWO PIECES</i> ADDITIONAL SHELVES (EACH) \$92 SOLID WOOD SHELVES (EACH) \$28					<b>3,150 W</b> <b>2,893 P</b>	<b>3,492 W</b> <b>3,217 P</b>
	<b>P1930</b> - _ - _	printer stand with paper slot one adjustable shelf	20	30	29	class 125 cwt 90 lb cu ft 13	<b>1,213 W</b> <b>1,039 P</b>	<b>1,311 W</b> <b>1,121 P</b>
	<b>P1830</b> - _ - _	<i>DESIGNED TO FIT CG1948 OR CG1848 COMPUTER GROUP.</i> ADDITIONAL SHELVES (EACH) \$92					<b>1,148 W</b> <b>975 P</b>	<b>1,238 W</b> <b>1,054 P</b>
	<b>CRP1948-29</b> - _ - _	computer printer stand one fixed shelf	24	48	29	class 125 cwt 115 lb cu ft 22	<b>1,829 W</b> <b>1,563 P</b>	<b>1,970 W</b> <b>1,686 P</b>
	<b>CRP1848-29</b> - _ - _	<i>ADDING CASTERS WILL MAKE OVERALL HEIGHT 31.5"</i>			<i>KNEESPACE: 44.5"</i>		<b>1,780 W</b> <b>1,513 P</b>	<b>1,917 W</b> <b>1,629 P</b>
	<b>CRP1948</b> - _ - _	computer printer stand one fixed shelf	24	48	26.25	class 125 cwt 115 lb cu ft 22	<b>1,829 W</b> <b>1,563 P</b>	<b>1,970 W</b> <b>1,686 P</b>
	<b>CRP1848</b> - _ - _	<i>ADD \$171 LIST AND SPECIFY FOR LOCKING DUAL WHEEL CASTERS FOR UNIT HEIGHT OF 26.25" ADD \$109 LIST AND SPECIFY FOR LOCKING DUAL WHEEL CASTERS FOR UNIT HEIGHT OF 28.25"</i>			<i>KNEESPACE: 44.5"</i>		<b>1,780 W</b> <b>1,513 P</b>	<b>1,917 W</b> <b>1,629 P</b>
	<b>CRP1936-29</b> - _ - _	computer printer stand one fixed shelf	24	36	29	class 125 cwt 95 lb cu ft 17	<b>1,322 W</b> <b>1,131 P</b>	<b>1,423 W</b> <b>1,220 P</b>
	<b>CRP1836-29</b> - _ - _	<i>ADDING CASTERS WILL MAKE OVERALL HEIGHT 31.5"</i>			<i>KNEESPACE: 32.5"</i>		<b>1,257 W</b> <b>1,079 P</b>	<b>1,358 W</b> <b>1,165 P</b>
	<b>CRP1936</b> - _ - _	computer printer stand one fixed shelf	24	36	26.25	class 125 cwt 95 lb cu ft 17	<b>1,322 W</b> <b>1,131 P</b>	<b>1,423 W</b> <b>1,220 P</b>
	<b>CRP1836</b> - _ - _	<i>ADD \$171 LIST AND SPECIFY FOR LOCKING DUAL WHEEL CASTERS FOR UNIT HEIGHT OF 26.25" ADD \$109 LIST AND SPECIFY FOR LOCKING DUAL WHEEL CASTERS FOR UNIT HEIGHT OF 28.25"</i>			<i>KNEESPACE: 32.5"</i>		<b>1,257 W</b> <b>1,079 P</b>	<b>1,358 W</b> <b>1,165 P</b>
	<b>BW1971</b> - _ - _	double bookcase four wood doors two adjustable shelves in each side	17	71	47.5	class 125 cwt 235 lb cu ft 41	<b>4,402 W</b> <b>3,704 P</b>	<b>4,753 W</b> <b>3,999 P</b>
	<b>BW1871</b> - _ - _	freestanding with base (bracket base not available)					<b>4,238 W</b> <b>3,538 P</b>	<b>4,582 W</b> <b>3,823 P</b>
	<b>BW1936</b> - _ - _	bookcase two wood doors two adjustable shelves	17	36	47.5	class 125 cwt 120 lb cu ft 21	<b>2,220 W</b> <b>1,980 P</b>	<b>2,395 W</b> <b>2,138 P</b>
	<b>BW1836</b> - _ - _	freestanding with base (bracket base not available)					<b>2,053 W</b> <b>1,814 P</b>	<b>2,220 W</b> <b>1,980 P</b>
		<i>ADDITIONAL SHELVES (EACH) \$92</i> <i>SOLID WOOD SHELVES (EACH) \$28</i>						

**laminated**  
tops only







**3L-P** saddle on walnut  
**4L-P** dark mahogany on walnut  
**25M-P** mahogany on walnut  
**25C-P** cherry on walnut

**veneered**  
tops only

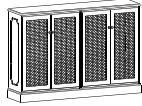
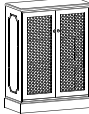
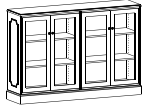
**3L-W** saddle on walnut  
**2KL-W** sepia on walnut  
**4L-W** dark mahogany on walnut  
**25M-W** mahogany on walnut  
**25C-W** cherry on walnut

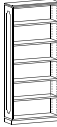
## CF1976-2KL-W

unit identification (type), top dimension, chassis option - **chassis & top finish - top material**  
1900 series with molding | 1800 series without molding

	model number	description	d	w	h	freight	list \$ zone 1	list \$ zone 2
	BG1971 - _ - _	double bookcase four wire grill doors two adjustable shelves in each side freestanding with base (bracket base not available)	17	71	47.5	class 125 cwt 235 lb cu ft 41	5,292 W 4,589 P	5,699 W 4,957 P
	BG1871 - _ - _						4,971 W 4,274 P	5,355 W 4,656 P
ADDITIONAL SHELVES (EACH) \$92 SOLID WOOD SHELVES (EACH) \$28								
	BG1936 - _ - _	bookcase two wire grill doors two adjustable shelves freestanding with base (bracket base not available)	17	36	47.5	class 125 cwt 120 lb cu ft 21	2,646 W 2,402 P	2,852 W 2,593 P
	BG1836 - _ - _						2,477 W 2,230 P	2,668 W 2,408 P
ADDITIONAL SHELVES (EACH) \$92 SOLID WOOD SHELVES (EACH) \$28								
	BD1971 - _ - _	double bookcase four glass doors two adjustable shelves in each side freestanding with base (bracket base not available)	17	71	47.5	class 125 cwt 235 lb cu ft 41	4,573 W 3,874 P	4,925 W 4,183 P
	BD1871 - _ - _						4,409 W 3,709 P	4,750 W 4,006 P
ADDITIONAL SHELVES (EACH) \$92 SOLID WOOD SHELVES (EACH) \$28								
	BD1936 - _ - _	bookcase two glass doors two adjustable shelves freestanding with base (bracket base not available)	17	36	47.5	class 125 cwt 120 lb cu ft 21	2,307 W 2,061 P	2,485 W 2,225 P
	BD1836 - _ - _						2,145 W 1,899 P	2,311 W 2,132 P
ADDITIONAL SHELVES (EACH) \$92 SOLID WOOD SHELVES (EACH) \$28								
	BC1984 - _ - _	bookcase four adjustable shelves one fixed shelf in center	12	36	84	class 125 cwt 145 lb cu ft 28	2,050 W 1,941 P	2,213 W 2,095 P
	BC1884 - _ - _						1,925 W 1,814 P	2,073 W 1,956 P
ADDITIONAL SHELVES (EACH) \$92 SOLID WOOD SHELVES (EACH) \$28								
	BC1972 - _ - _	bookcase three adjustable shelves one fixed shelf in center	12	36	72	class 125 cwt 135 lb cu ft 24	1,799 W 1,689 P	1,938 W 1,824 P
	BC1872 - _ - _						1,735 W 1,624 P	1,867 W 1,756 P
ADDITIONAL SHELVES (EACH) \$92 SOLID WOOD SHELVES (EACH) \$28								
	BC1960 - _ - _	bookcase two adjustable shelves one fixed shelf in center	12	36	60	class 125 cwt 110 lb cu ft 20	1,582 W 1,490 P	1,720 W 1,610 P
	BC1860 - _ - _						1,462 W 1,354 P	1,580 W 1,461 P
ADDITIONAL SHELVES (EACH) \$92 SOLID WOOD SHELVES (EACH) \$28								
	BC1948 - _ - _	bookcase one adjustable shelf one fixed shelf	12	36	48	class 125 cwt 96 lb cu ft 16	1,348 W 1,237 P	1,451 W 1,335 P
	BC1848 - _ - _						1,264 W 1,155 P	1,364 W 1,245 P
ADDITIONAL SHELVES (EACH) \$92 SOLID WOOD SHELVES (EACH) \$28								
	BC1936 - _ - _	bookcase two adjustable shelves	12	36	36	class 125 cwt 85 lb cu ft 12	1,195 W 1,087 P	1,290 W 1,174 P
	BC1836 - _ - _						1,090 W 983 P	1,178 W 1,061 P
ADDITIONAL SHELVES (EACH) \$92 SOLID WOOD SHELVES (EACH) \$28								

top  
P laminate top  
W veneer top

edge











monticello/empire | 1900/1800 series | wood top, veneer chassis, veneer drawer fronts  
 1900 series with molding | 1800 series without molding | laminate top, veneer chassis, veneer drawer fronts

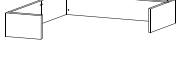

model number	description	d	w	h	freight	list \$ zone 1	list \$ zone 2
BC1930 - _ - _	bookcase one adjustable shelf	12	36	30	class 125 cwt 80 lb cu ft 11	1,130 W 1,023 P	1,221 W 1,105 P
BC1830 - _ - _	ADDITIONAL SHELVES (EACH) \$92 SOLID WOOD SHELVES (EACH) \$28					974 W 864 P	1,051 W 934 P

monticello/empire  
1900/1800

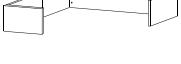
laminate tops only	3L-P	saddle on walnut
	4L-P	dark mahogany on walnut
	25M-P	mahogany on walnut
	25C-P	cherry on walnut
veneer tops only	3L-W	saddle on walnut
	2KL-W	sepia on walnut
	4L-W	dark mahogany on walnut
	25M-W	mahogany on walnut
	25C-W	cherry on walnut

	model number	description	d	w	h	freight	list \$ zone 1	list \$ zone 2
	TD1972 - _ - _	desk top transaction counter for use with 72" desk only	12	72	15.25	class 85 kd cwt 90 lb cu ft 6	1,118	1,202
	TD1872 - _ - _						1,118	1,202
	TD1966 - _ - _	desk top transaction counter for use with 66" desk only	12	66	15.25	class 85 kd cwt 84 lb cu ft 6	1,118	1,202
	TD1866 - _ - _						1,118	1,202
	TD196630 - _ - _	desk top transaction counter for use with 30" x 66" desk only	12	66	15.25	class 85 kd cwt 84 lb cu ft 6	1,118	1,202
	TD1960 - _ - _							
	TD186630 - _ - _	TD1960 AND TD1860 DIMENSIONS: 12"D x 60"W x 15.25"H	12	66	15.25	class 85 kd cwt 84 lb cu ft 6	1,118	1,202
	TD1860 - _ - _							
	TM1972R - _ - _	desk top transaction/reception gallery for use with executive height 72" "I" units	12	72	15.25	class 85 kd cwt 100 lb cu ft 6	1,653	1,777
	TM1872R - _ - _	GALLERY 84"D x 72"W x 14"H					1,653	1,777
	TM1972L - _ - _	desk top transaction/reception gallery for use with executive height 72" "I" unit	12	72	15.25	class 85 kd cwt 100 lb cu ft 6	1,653	1,777
	TM1872L - _ - _	GALLERY 84"D x 72"W x 14"H					1,653	1,777
	TM1966R - _ - _	desk top transaction/reception gallery for use with executive height 66" "I" unit	12	66	15.25	class 85 kd cwt 94 lb cu ft 6	1,653	1,777
	TM1866R - _ - _	GALLERY 78"D x 66"W x 14"H					1,653	1,777
	TM1966L - _ - _	desk top transaction/reception gallery for use with executive height 66" "I" unit	12	66	15.25	class 85 kd cwt 94 lb cu ft 6	1,653	1,777
	TM1866L - _ - _	GALLERY 78"D x 66"W x 14"H					1,653	1,777
	TM196630R - _ - _	desk top transaction/reception gallery for use with 30" executive height 66" "I" unit	12	66	15.25	class 85 kd cwt 94 lb cu ft 6	1,653	1,777
	TM186630R - _ - _	GALLERY 78"D x 66"W x 14"H					1,653	1,777
	TM196630L - _ - _	desk top transaction/reception gallery for use with 30" x 66" "I" unit	12	66	15.25	class 85 kd cwt 94 lb cu ft 6	1,653	1,777
	TM186630L - _ - _	GALLERY 78"D x 66"W x 14"H					1,653	1,777

top

P laminate top  
W veneer top

edge



monticello/empire  
1900 series with molding

1900/1800 series  
1800 series without molding

wood top, veneer chassis, veneer drawer fronts  
laminate top, veneer chassis, veneer drawer fronts



monticello/empire  
1900/1800

	model number	description	d	w	h	freight	list \$ zone 1	list \$ zone 2
	TM1960R - _ - _	desk top transaction/reception gallery for use with 60" right "u" unit	12	60	14	class 125 cwt 90 lb cu ft 6	1,653	1,777
	TM1860R - _ - _	GALLERY 72"D X 60" W X 14"H					1,653	1,777
	TM1960L - _ - _	desk top transaction/reception gallery for use with 60" left "u" unit	12	60	14	class 125 cwt 90 lb cu ft 6	1,653	1,777
	TM1860L - _ - _	GALLERY 72"D X 60" W X 14"H					1,653	1,777
	TU1972R - _ - _	desk top transaction/reception gallery for use with 72" right executive "u" unit only	12	72	14	class 125 cwt 150 lb cu ft 8	2,234	2,406
	TU1872R - _ - _	GALLERY 15.25"					2,234	2,406
	TU1972L - _ - _	desk top transaction/reception gallery for use with 72" left executive "u" unit only	12	72	14	class 125 cwt 150 lb cu ft 8	2,234	2,406
	TU1872L - _ - _	GALLERY 15.25"					2,234	2,406
	TU1966R - _ - _	desk top transaction/reception gallery for use with 66" right executive "u" unit only	12	66	15.25	class 125 cwt 140 lb cu ft 8	2,234	2,406
	TU1866R - _ - _	GALLERY 14"					2,234	2,406
	TU1966L - _ - _	desk top transaction/reception gallery for use with 66" left executive "u" unit only	12	66	15.25	class 125 cwt 140 lb cu ft 8	2,234	2,406
	TU1866L - _ - _	GALLERY 14"					2,234	2,406
	TU196630R - _ - _	desk top transaction/reception gallery for use with 30" x 66" "u" unit	12	66	15.25	class 125 cwt 145 lb cu ft 8	2,234	2,406
	TU186630R - _ - _	GALLERY 98"D X 14"H					2,234	2,406
	TU196630L - _ - _	desk top transaction/reception gallery for use with 30" x 66" "u" unit	12	66	15.25	class 125 cwt 145 lb cu ft 8	2,234	2,406
	TU186630L - _ - _	GALLERY 98"D X 14"H					2,234	2,406
	T1948-29 - _ - _	sofa table  CAN SHIP UPS	18	48	29	class 85 kd cwt 50 lb cu ft 3	1,084 W 785 P	1,168 W 849 P
	T1848-29 - _ - _						1,084 W 785 P	1,168 W 849 P



laminate  
tops only

3L-P saddle on walnut  
4L-P dark mahogany on walnut  
25M-P mahogany on walnut  
25C-P cherry on walnut

veneer  
tops only

3L-W saddle on walnut  
2KL-W sepia on walnut  
4L-W dark mahogany on walnut  
25M-W mahogany on walnut  
25C-W cherry on walnut

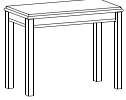
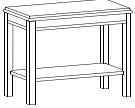
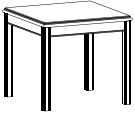
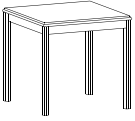
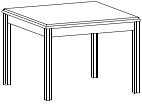
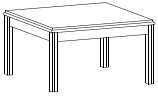
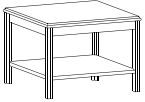

	model number	description	d	w	h	freight	list \$ zone 1	list \$ zone 2
	T1948 - _ - _	coffee table <small>CAN SHIP UPS</small>	18	48	17	class 85 kd cwt 40 lb cu ft 3	860 W 565 P	930 W 608 P
	T1848 - _ - _						860 W 565 P	930 W 608 P
	ET1928 - _ - _	end table <small>CAN SHIP UPS</small>	28	15	22	class 85 kd cwt 26 lb cu ft 2	590 W 435 P	639 W 468 P
	ET1828 - _ - _						590 W 435 P	639 W 468 P
	ET1928S - _ - _	end table with shelf <small>CAN SHIP UPS</small>	28	15	22	class 85 kd cwt 30 lb cu ft 2	733 W 579 P	793 W 627 P
	ET1828S - _ - _						733 W 579 P	793 W 627 P
	T1924-22 - _ - _	lamp table <small>CAN SHIP UPS</small>	24	24	22	class 85 kd cwt 50 lb cu ft 3	647 W 468 P	697 W 508 P
	T1824-22 - _ - _						647 W 468 P	697 W 508 P
	T1930-29 - _ - _	lamp table <small>CAN SHIP UPS</small>	30	30	29	class 85 kd cwt 50 lb cu ft 3	1,069 W 735 P	1,152 W 796 P
	T1830-29 - _ - _						1,069 W 735 P	1,152 W 796 P
	T1930-22 - _ - _	lamp table <small>CAN SHIP UPS</small>	30	30	22	class 85 kd cwt 45 lb cu ft 3	849 W 516 P	914 W 558 P
	T1830-22 - _ - _						849 W 516 P	914 W 558 P
	T1930-17 - _ - _	lamp table <small>CAN SHIP UPS</small>	30	30	17	class 85 kd cwt 46 lb cu ft 3	808 W 476 P	869 W 513 P
	T1830-17 - _ - _						808 W 476 P	869 W 513 P
	T1930S - _ - _	lamp table with shelf <small>CAN SHIP UPS</small>	30	30	22	class 125 cwt 64 lb cu ft 3	1,108 W 775 P	1,192 W 837 P
	T1830S - _ - _						1,108 W 775 P	1,192 W 837 P
	SC1937 - _ - _	serving cart	20	36.6	30.5	class 125 cwt 185 lb cu ft 16	2,455	2,650
	SC1837 - _ - _						2,297	2,479

top

P laminate top  
W veneer top





edge



monticello/empire | 1900/1800 series | wood top, veneer chassis, veneer drawer fronts  
 1900 series with molding | 1800 series without molding | laminate top, veneer chassis, veneer drawer fronts

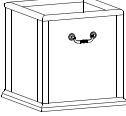
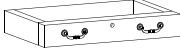
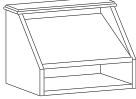

monticello/empire  
1900/1800

	model number	description	d w h	freight	list \$ zone 1	list \$ zone 2
	TC1920 - _ - _  TC1820 - _ - _	telephone cabinet fixed shelf with hinged door storage	19.2 19.2 29	class 125 cwt 85 lb cu ft 8	1,215 W 1,028 P  1,197 W 1,014 P	1,311 W 1,110 P  1,294 W 1,091 P
	W1914 - _ - _  W1814 - _ - _	waste receptacle  <i>CAN SHIP UPS</i>	14 14 14.5	class 200 cwt 9 lb cu ft 2	355  355	381  381
	KBCD1900 - _ - _  KBCD1800 - _ - _	flip front keyboard drawer  <i>FACTORY INSTALLED ONLY SPECIFY GROMMET LOCATION</i>	14 CUSTOM 3.5	class cwt lb cu ft	585  585	636  636
	TLS - _ - _	traditional lectern stand	22 30 20	class 125 cwt lb cu ft	983	1,099
	CO1966 - _  CO1866 - _	costumer  <i>CAN SHIP UPS</i>	66	class 85 kd cwt 10 lb cu ft .5	202	216
	RO120  SB-18-29	rectangular top with slab bases (2 piece veneer top/wood edge)  slab wood bases with empire detailing  <i>BASES: 4"D x 29"W x 27.75"H</i>	120 48	class cwt 235 lb cu ft	4,958	5,354  as shown
	BS9648  QA	boat shape top with queen anne bases  queen anne styling  <i>BASES: 34"D x 34"W x 27.75"H</i>	96 48	class cwt 235 lb cu ft	4,395	4,599  as shown
	CP60 <i>LAMINATE TOP/PVC EDGE</i>  XB18-36	circular top with wood "x" base  wood "x" base traditional with empire styling	60	class cwt 75 lb cu ft	1,515	1,638  as shown

laminate tops only	3L-P	saddle on walnut
	4L-P	dark mahogany on walnut
	25M-P	mahogany on walnut
	25C-P	cherry on walnut
veneer tops only	3L-W	saddle on walnut
	2KL-W	sepia on walnut
	4L-W	dark mahogany on walnut
	25M-W	mahogany on walnut
	25C-W	cherry on walnut

# inwood

OFFICE  
ENVIRONMENTS

## price list

effective 01 january 2012

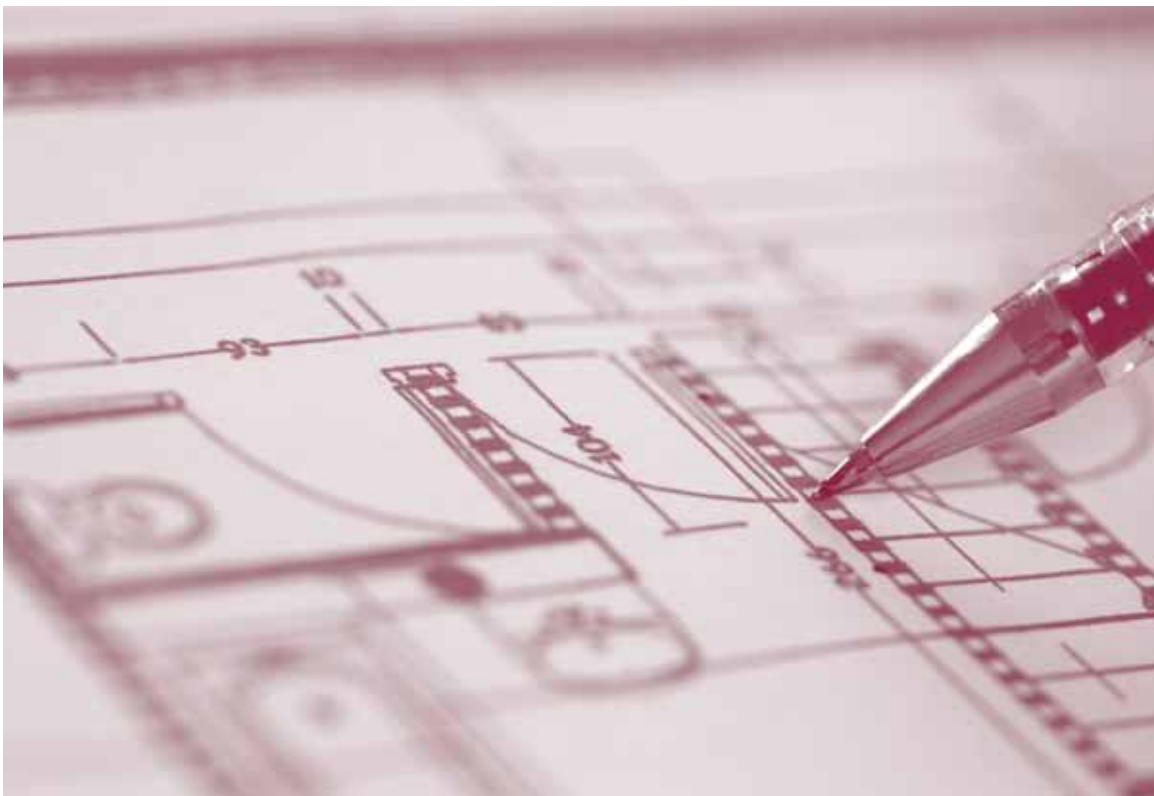

account # \_\_\_\_\_  
discount \_\_\_\_\_  
zone \_\_\_\_\_  
c.s.r. \_\_\_\_\_  
sales rep. \_\_\_\_\_

### magnus

1200

[click here for warranty  
and terms information](#)

zones one and two





magnus  
1200

**magnus 1200 series specifications****materials:**

All wood is thoroughly air and kiln dried to a moisture content not to exceed 8% at the time of assembly.

**veneers:**

All exposed surfaces are plain sliced American Black Walnut. Veneers are carefully book-matched and balanced. All drawer fronts, doors, end panels, and modesty panels are vertical grain genuine Walnut.

**top work surfaces:**

High pressure laminate tops are 1 1/4" thick, 3-ply construction; consisting of high-pressure laminate work surface and a 45 lb density flake board core. The under side of the top has a smooth surface Gator-Ply backing sheet. Top rims are solid hardwood with a traditional edge shape.

**pedestal construction:**

3/4" thick 3-ply panel with 1 1/16" veneer wrapped mdf posts with softened edges. American Black Walnut veneer on all exposed surfaces and a 45 lb density flake board core. Each pedestal in desk units has a 3-ply dictation arm slide mounted above the drawers. In the desk and credenza units each pedestal has one box drawer over one file drawer. The base is constructed and shaped in veneer wrapped mdf; adjustable leveling glides are mounted in each corner of the base. All joints are reinforced with concealed wood glue blocks. All bookcase shelves are standard 3/4" thick.

**drawers:**

Drawers are 3/4" thick, 3-ply construction drawer fronts with vertical book matched Walnut veneer. Drawer edges are wrapped on top and sides with matching Walnut. All drawer sides and backs are plywood, dovetailed front and back with 3-ply drawer bottoms. Drawer bottoms are framed on four sides and stapled from the bottom side. Drawer interiors are finished with a clear coat lacquer sealer to prevent swelling or shrinkage. Box drawers have a high grade Sterling metal ball-bearing drawer suspension. File drawers have a high grade Sterling metal ball bearing full progressive suspension and are equipped with metal rods for hanging file folders. All drawers have smooth quiet operation. Pedestals have one file drawer and one box drawer each. Drawer hardware is an Antique Brass English bail pull. Each desk is standard with a center drawer with a high grade Sterling suspension and a solid wood pen and pencil tray.

**inside drawer dimensions:**

box drawers: 4" H x 12 1/8" W x 15 9/16" L  
4" H x 12 1/8" W x 22 1/8" L  
file drawers: 9 1/2" H x 12 1/8" W x 15 9/16" L  
9 1/2" H x 12 1/8" W x 25 3/8" L  
lateral files: 9 1/2" H x 25 1/4" W x 15 7/16" L

**locking:**

Each pedestal has its own locking mechanism that also locks the center drawer. Each unit is equipped with two keys. Units may be keyed alike in groups (per office, if requested) for an additional charge of \$36 list per unit.

**finish:**

All Inwood finishes are catalyzed varnish and have excellent durability. Our multi-step satin finishes leave an open grain natural look to the furniture, and are available in the following finishes: (3L) saddle on walnut, (25M) mahogany on walnut, (4L) dark mahogany on walnut, and (25C) cherry on walnut.

**grommets:**

Standard black grommets. Optional silver available (no upcharge)



---

**magnus**

**desks**

letter  
front to back

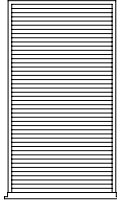

letter  
side to side

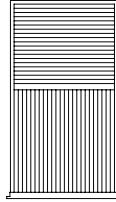

letter/legal  
combination

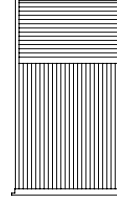

---

**returns  
and  
credenzas**

letter  
front to back

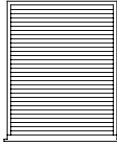

letter  
side to side

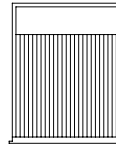

---

**lateral files**

letter  
side to side

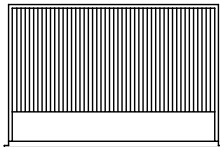



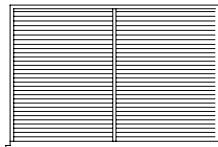

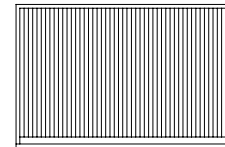

letter  
front to back

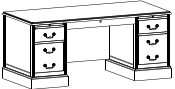

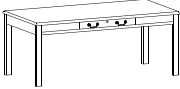
legal  
side to side

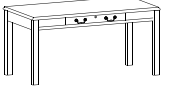

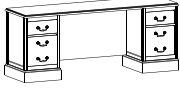
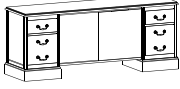

	model number	description	d	w	h	freight	list \$ zone 1	list \$ zone 2
[ QS ] 	<b>CF1272 -</b> ___ Quick Ship available in 25M mahogany or 25C cherry	conference desk double pedestal desk center drawer arm slide and box/file drawer in both pedestals	36	72	29	class 125 cwt 285 lb cu ft 53  <i>APPROACH: 6"</i> <i>KNEESPACE: 28"</i>	<b>2,519</b>	<b>2,721</b>
	<b>F126630 -</b> ___	double pedestal desk center drawer arm slide and box/file drawer in both pedestals	30	66	29	class 125 cwt 265 lb cu ft 40  <i>KNEESPACE: 32.5"</i>	<b>2,806</b>	<b>3,030</b>
[ QS ] 	<b>F1260 -</b> ___ Quick Ship available in 25M mahogany or 25C cherry	double pedestal desk center drawer arm slide and box/file drawer in both pedestals	30	60	29	class 125 cwt 255 lb cu ft 37  <i>KNEESPACE: 26.5"</i>	<b>2,373</b>	<b>2,563</b>
	<b>T1272 -</b> ___	table desk locking center drawer square legs	36	72	29	class 85 kd cwt 135 lb cu ft 14  <i>KNEESPACE: 66"</i>	<b>1,709</b>	<b>1,848</b>
	<b>T1272TL -</b> ___	table desk locking center drawer turned legs	36	72	29	class 85 kd cwt 135 lb cu ft 14  <i>KNEESPACE: 66"</i>	<b>1,847</b>	<b>1,995</b>
	<b>T1260 -</b> ___	table desk locking center drawer square legs	30	60	29	class 85 kd cwt 110 lb cu ft 9  <i>KNEESPACE: 54"</i>	<b>1,352</b>	<b>1,457</b>
[ QS ] 	<b>T1260TL -</b> ___ Quick Ship available in 25M mahogany or 25C cherry	table desk locking center drawer turned legs	30	60	29	class 85 kd cwt 110 lb cu ft 9  <i>KNEESPACE: 54"</i>	<b>1,619</b>	<b>1,746</b>
	<b>CR1272 -</b> ___	kneespace credenza box/file pedestal on each side	20	72	29	class 125 cwt 205 lb cu ft 28  <i>KNEESPACE: 38"</i>	<b>1,848</b>	<b>1,991</b>
	<b>CR1272D -</b> ___ <b>CR127224D -</b> ___	credenza box/file pedestal on each side sliding doors in center area with one adjustable shelf	20	72	29	class 125 cwt 235 lb cu ft 28	<b>2,589</b>	<b>2,795</b>
		<i>ADDITIONAL SHELVES (EACH) \$92</i> <i>SOLID WOOD SHELVES (EACH) \$28</i>	24	72	29		<b>2,654</b>	<b>2,866</b>

top P laminate top

edge



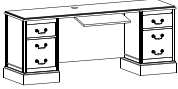

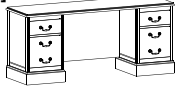
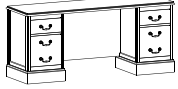
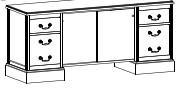
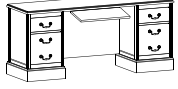
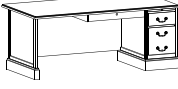
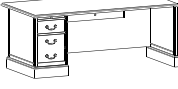
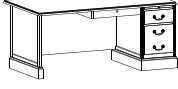

	model number	description	d	w	h	freight	list \$ zone 1	list \$ zone 2
	<b>CR1272KB</b> - __	kneespace credenza with keyboard box/file pedestal on each side  <i>ARTICULATING KEYBOARD HEIGHT ADJUSTMENT FROM 26.5 - 29"</i>	20	72	29	class 125 cwt 220 lb cu ft 34  <i>KNEESPACE: 38"</i>	<b>2,226</b>	<b>2,410</b>
	<b>CR127224</b> - __	computer depth credenza box/file pedestal on each side  <i>KNEESPACE: 38"</i>	24	72	29	class 125 cwt 220 lb cu ft 34	<b>2,117</b>	<b>2,286</b>
[ QS ] 	<b>CR1266</b> - __  <i>Quick Ship available in 25M mahogany or 25C cherry</i>	kneespace credenza box/file pedestal on each side  <i>KNEESPACE: 32"</i>	20	66	29	class 125 cwt 170 lb cu ft 26	<b>1,749</b>	<b>1,945</b>
	<b>CR126624</b> - __	computer depth credenza box/file pedestal on each side  <i>KNEESPACE: 32"</i>	24	66	29	class 125 cwt 215 lb cu ft 30	<b>1,893</b>	<b>2,040</b>
[ QS ] 	<b>CR1266D</b> - __  <i>Quick Ship available in 25M mahogany or 25C cherry</i>	storage credenza box/file pedestal on each side sliding doors in center with one adjustable shelf  <i>ADDITIONAL SHELVES (EACH) \$92 SOLID WOOD SHELVES (EACH) \$28</i>	20	66	29	class 125 cwt 210 lb cu ft 30	<b>2,424</b>  <b>2,568</b>	<b>2,739</b>  <b>2,774</b>
[ QS ] 	<b>CR1266KB</b> - __  <i>Quick Ship available in 25M mahogany or 25C cherry</i>	kneespace credenza with keyboard box/file pedestal on each side  <i>ARTICULATING KEYBOARD HEIGHT ADJUSTMENT FROM 26.5 - 29"</i>	20	66	29	class 125 cwt 180 lb cu ft 26  <i>KNEESPACE: 32"</i>	<b>2,154</b>	<b>2,327</b>
	<b>D1272R</b> - __	single pedestal desk right box/file pedestal includes center drawer arm slide  <i>APPROACH: 6" KNEESPACE: 53"</i>	36	72	29	class 125 cwt 215 lb cu ft 53	<b>2,323</b>	<b>2,502</b>
	<b>D1272L</b> - __	single pedestal desk left box/file pedestal includes center drawer arm slide  <i>APPROACH: 6" KNEESPACE: 53"</i>	36	72	29	class 125 cwt 215 lb cu ft 53	<b>2,323</b>	<b>2,502</b>
[ QS ] 	<b>D1266R</b> - __  <i>Quick Ship available in 25M mahogany or 25C cherry</i>	single pedestal desk right box/file pedestal includes center drawer arm slide	36	66	29	class 125 cwt 205 lb cu ft 48  approach: 6" kneespace: 47"	<b>2,177</b>	<b>2,352</b>

lamine top  
tops only

**3L-P** saddle on walnut lamine  
**4L-P** dark mahogany on walnut lamine  
**25M-P** mahogany on walnut lamine  
**25C-P** cherry on walnut lamine

fake front \$603 list upcharge

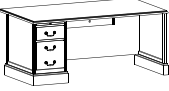
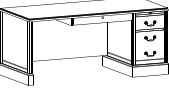
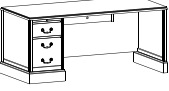
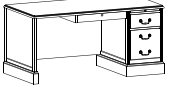
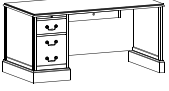
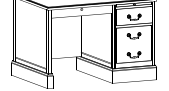

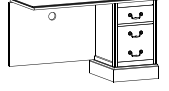
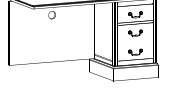
	model number	description	d	w	h	freight	list \$ zone 1	list \$ zone 2
[ QS ] 	<b>D1266L</b> - __ Quick Ship available in 25M mahogany or 25C cherry	single pedestal desk left box/file pedestal includes center drawer arm slide	36	66	29	class 125 cwt 205 lb cu ft 48 approach: 6" kneespace: 47"	<b>2,177</b>	<b>2,352</b>
	<b>D126630R</b> - __	single pedestal desk right box/file pedestal includes center drawer arm slide	30	66	29	class 125 cwt 195 lb cu ft 40 KNEESPACE: 47"	<b>2,117</b>	<b>2,346</b>
	<b>D126630L</b> - __	single pedestal desk left box/file pedestal includes center drawer arm slide	30	66	29	class 125 cwt 195 lb cu ft 40 KNEESPACE: 47"	<b>2,117</b>	<b>2,346</b>
	<b>D1260R</b> - __	single pedestal desk right box/file pedestal includes center drawer arm slide	30	60	29	class 125 cwt 180 lb cu ft 37 KNEESPACE: 41"	<b>1,781</b>	<b>1,924</b>
	<b>D1260L</b> - __	single pedestal desk left box/file pedestal includes center drawer arm slide	30	60	29	class 125 cwt 180 lb cu ft 37 KNEESPACE: 41"	<b>1,781</b>	<b>1,924</b>
	<b>D1242R</b> - __	single pedestal desk right box/file pedestal includes center drawer arm slide	30	42	29	class 125 cwt 165 lb cu ft 26 KNEESPACE: 23.5"	<b>1,671</b>	<b>1,799</b>
	<b>D1242L</b> - __	single pedestal desk left box/file pedestal includes center drawer arm slide	30	42	29	class 125 cwt 165 lb cu ft 26 KNEESPACE: 23.5"	<b>1,671</b>	<b>1,799</b>
[ QS ] 	<b>R1248R-EH</b> - __ Quick Ship available in 25M mahogany or 25C cherry	single pedestal return right box/file pedestal	24	48	29	class 125 cwt 165 lb cu ft 25 kneespace: 30"	<b>1,417</b>	<b>1,531</b>
[ QS ] 	<b>R1248L-EH</b> - __ Quick Ship available in 25M mahogany or 25C cherry	single pedestal return left box/file pedestal	24	48	29	class 125 cwt 165 lb cu ft 25 kneespace: 30"	<b>1,417</b>	<b>1,531</b>

top



P laminate top

fake front \$603 list upcharge

edge



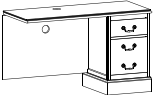
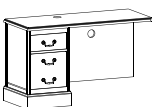

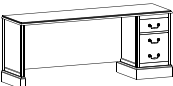
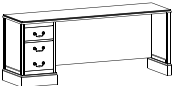
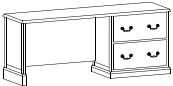
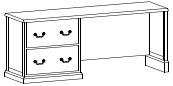
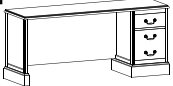
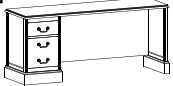
	model number	description	d	w	h	freight	list \$ zone 1	list \$ zone 2
	<b>R124820R-EH</b> - __	single pedestal return right box/file pedestal  <i>FOR USE WITH D1260</i>	20	48	29	class 125 cwt 160 lb cu ft 25  <i>KNEESPACE: 30"</i>	<b>1,417</b>	<b>1,531</b>
	<b>R124820L-EH</b> - __	single pedestal return left box/file pedestal  <i>FOR USE WITH D1260</i>	20	48	29	class 125 cwt 160 lb cu ft 25  <i>KNEESPACE: 30"</i>	<b>1,417</b>	<b>1,531</b>
	<b>B1248-EH</b> - __  <b>B124824-EH</b> - __	bridge open knee space	20  24	48	29	class 125 cwt 65 lb cu ft 3  <i>KNEESPACE: 48"</i>	<b>471</b>  <b>481</b>	<b>509</b>  <b>520</b>
	<b>C1272R</b> - __  <b>C127224R</b> - __	single pedestal credenza right box/file pedestal	20  24	72	29	class 125 cwt 180 lb cu ft 28  <i>KNEESPACE: 53"</i>	<b>2,443</b>  <b>2,509</b>	<b>2,640</b>  <b>2,709</b>
	<b>C1272L</b> - __  <b>C127224L</b> - __	single pedestal credenza left box/file pedestal	20  24	72	29	class 125 cwt 180 lb cu ft 28  <i>KNEESPACE: 53"</i>	<b>2,443</b>  <b>2,509</b>	<b>2,640</b>  <b>2,709</b>
	<b>C1272R-2F</b> - __  <b>C127224R-2F</b> - __	single pedestal credenza right lateral file pedestal	20  24	72	29	class 125 cwt 225 lb cu ft 28  <i>KNEESPACE: 40"</i>	<b>2,836</b>  <b>2,901</b>	<b>3,031</b>  <b>3,133</b>
	<b>C1272L-2F</b> - __  <b>C127224L-2F</b> - __	single pedestal credenza left lateral file pedestal	20  24	72	29	class 125 cwt 225 lb cu ft 28  <i>KNEESPACE: 40"</i>	<b>2,836</b>  <b>2,901</b>	<b>3,031</b>  <b>3,133</b>
<b>[ QS ]</b> 	<b>C1266R</b> - __  <b>C126624R</b> - __	single pedestal credenza right box/file pedestal  <i>Quick Ship available in 25M mahogany or 25C cherry</i>	20  24	66	29	class 125 cwt 170 lb cu ft 26  <i>kneespace: 47"</i>	<b>1,901</b>  <b>1,967</b>	<b>1,980</b>  <b>2,124</b>
<b>[ QS ]</b> 	<b>C1266L</b> - __  <b>C126624L</b> - __	single pedestal credenza left box/file pedestal  <i>Quick Ship available in 25M mahogany or 25C cherry</i>	20  24	66	29	class 125 cwt 170 lb cu ft 26  <i>KNEESPACE: 47"</i>	<b>1,901</b>  <b>1,967</b>	<b>1,980</b>  <b>2,124</b>

laminates  
tops only

**3L-P** saddle on walnut laminate  
**4L-P** dark mahogany on walnut laminate  
**25M-P** mahogany on walnut laminate  
**25C-P** cherry on walnut laminate

magnus  
1200

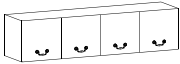
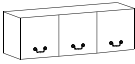
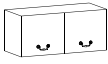
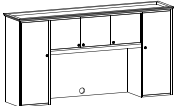
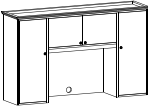
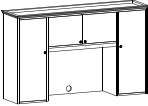
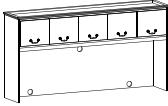
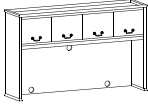
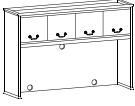
	model number	description	d	w	h	freight	list \$ zone 1	list \$ zone 2
	WH1266 - __	66" wide wall hung overhead unit four hinged doors	16	66	16	class 125 cwt 110 lb cu ft 13	1,792	1,935
	WH1248 - __	48" wide wall hung overhead unit three hinged doors	16	48	16	class 125 cwt 90 lb cu ft 10	1,541	1,665
	WH1236 - __	36" wide wall hung overhead unit two hinged doors	16	36	16	class 125 cwt 75 lb cu ft 7	1,010	1,090
	FH1284 - __	84" wide overhead storage unit two full hinged doors three half hinged doors two adjustable shelves on each side two wire management grommets	17.5	82.5	43.25	class 125 cwt 260 lb cu ft 40  OPENING: 24.25	3,693	3,989
	FH1272 - __	72" wide overhead storage unit two full hinged doors two half hinged doors two adjustable shelves on each side two wire management grommets	17.5	71	43.25	class 125 cwt 260 lb cu ft 40  OPENING: 24.25	2,943	3,843
	FH1266 - __	66" wide overhead storage unit two full hinged doors two half hinged doors two adjustable shelves on each side two wire management grommets	17.5	65	43.25	class 125 cwt 247 lb cu ft 38  OPENING: 24.25	2,834	3,706
	OU1284 - __	84" wide overhead storage unit five hinged doors three wire management grommets	17.5	82.5	43.25	class 125 cwt 247 lb cu ft 38  OPENING: 25.63	3,597	3,883
	OU1272 - __	72" wide overhead storage unit four hinged doors three wire management grommets	17.5	70.8	43.25	class 125 cwt 190 lb cu ft 40  OPENING: 25.63	2,845	3,073
[ QS ] 	OU1266 - __ <small>Quick Ship available in 25M mahogany or 25C cherry</small>	66" wide overhead storage unit four hinged doors three wire management grommets	17.5	64.8	43.25	class 125 cwt 180 lb cu ft 38  opening: 25.63	2,493	2,941

top





P laminate top

for **tackboard options**, see pages 522-523  
for standard fabrics available on tackboards, see page 504

edge



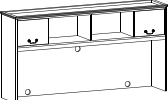
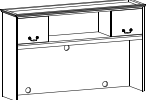
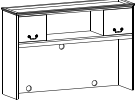
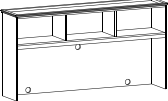
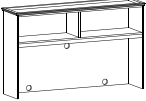
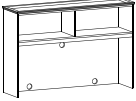







	model number	description	d	w	h	freight	list \$ zone 1	list \$ zone 2
	OU1248 - __	48" wide overhead storage unit three hinged doors two wire management grommets	17.5	47	48	class 125 cwt 200 lb cu ft 40  OPENING: 25.63	2,211	2,389
	OU1230 - __	30" wide overhead storage unit with open center two hinged doors two wire management grommets	17.5	29	43.25	class 125 cwt 200 lb cu ft 40  OPENING: 25.63	1,936	2,091
	OD1284 - __	84" wide overhead storage unit with open center one hinged door on each end three wire management grommets	17.5	82.5	43.25	class 125 cwt 200 lb cu ft 40  OPENING: 25.63	3,890	4,200
	OD1272 - __	72" wide overhead storage unit with open center one hinged door on each end three wire management grommets	17.5	70.8	43.25	class 125 cwt 200 lb cu ft 40  OPENING: 25.63	2,552	2,757
	OD1266 - __	66" wide open overhead storage unit with open center three wire management grommets	17.5	64.8	43.25	class 125 cwt 175 lb cu ft 38  OPENING: 25.63	2,287	2,470
	OO1284 - __	84" wide open overhead storage unit with open center three wire management grommets	17.5	82.5	43.25	class 125 cwt 195 lb cu ft 40  OPENING: 25.63	2,734	2,952
	OO1272 - __	72" wide open overhead storage unit with open center three wire management grommets	17.5	71	43.25	class 125 cwt 195 lb cu ft 40  OPENING: 25.63	2,006	2,166
[ QS ] 	OO1266 - __ Quick Ship available in 25M mahogany or 25C cherry	66" wide open overhead storage unit with open center three wire management grommets	17.5	64.8	43.25	class 125 cwt 175 lb cu ft 38  opening: 25.63	1,993	2,154
	USU84 - __	underside paper storage for use with 84" storage overhead units; does not prevent the use of task lights or tackboards  FACTORY INSTALLED	15.5	82	4		512	554

laminate  
tops only

3L-P saddle on walnut laminate  
4L-P dark mahogany on walnut laminate  
25M-P mahogany on walnut laminate  
25C-P cherry on walnut laminate

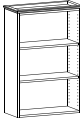
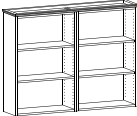
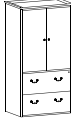
magnus  
1200







	model number	description	d	w	h	freight	list \$ zone 1	list \$ zone 2
	USU72 - __	underside paper storage for use with 72" storage overhead units; does not prevent the use of task lights or tackboards  <i>FACTORY INSTALLED</i>	15.5	70	4		498	536
	USU66 - __	underside paper storage for use with 66" storage overhead units; does not prevent the use of task lights or tackboards  <i>FACTORY INSTALLED</i>	15.5	64	4		498	536
	USU48 - __	underside paper storage for use with 48" storage overhead units; does not prevent the use of task lights or tackboards  <i>FACTORY INSTALLED</i>	15.5	46	4		292	315
	USU30 - __	underside paper storage for use with 29" storage overhead units; does not prevent the use of task lights or tackboards  <i>FACTORY INSTALLED</i>	15.5	29	4		292	315
[ QS ] 	H1229 - __ <small>Quick Ship available in 25M mahogany or 25C cherry</small>	open hutch w/two adjustable shelves  <i>ADDITIONAL SHELVES (EACH) \$92</i> <i>SOLID WOOD SHELVES (EACH) \$28</i>  <i>SET UNIT ON HW1230 OR 2FD1230</i>	13	29	43.25	class 125 cwt 65 lb cu ft 12	1,103	1,186
	H1257 - __	double open hutch  <i>ADDITIONAL SHELVES (EACH) \$92</i> <i>SOLID WOOD SHELVES (EACH) \$28</i>  set unit on 4fd1260	13	29	43.25	class 125 cwt 65 lb cu ft 12	2,158	2,311
	HW12722F - __	storage cabinet hinged doors with 2 adjustable shelves upper, lateral file below  <i>ADDITIONAL SHELVES (EACH) \$92</i> <i>SOLID WOOD SHELVES (EACH) \$28</i>	24	36	72	class 125 cwt 320 lb cu ft 43	5,199	5,615
	HW1272HW - __	storage cabinet hinged doors with 2 adjustable shelves upper and 1 lower adjustable shelf  <i>ADDITIONAL SHELVES (EACH) \$92</i> <i>SOLID WOOD SHELVES (EACH) \$28</i>	24	36	72	class 125 cwt 270 lb cu ft 43	4,980	5,384
	HW1230 - __	hinged door cabinet two wood doors one adjustable shelf  <i>ADDITIONAL SHELVES (EACH) \$92</i> <i>SOLID WOOD SHELVES (EACH) \$28</i>	20	30	29	class 125 cwt 105 lb cu ft 13	1,236	1,305

top P laminate top

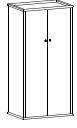
edge

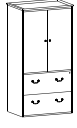
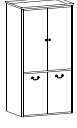
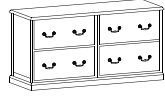

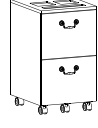

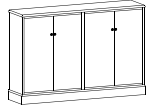

	model number	description	d	w	h	freight	list \$ zone 1	list \$ zone 2
	<b>WD1272</b> - __	wardrobe two hinged doors right side coat storage, left side three adjustable shelves, storage shelf above <i>ADDITIONAL SHELVES (EACH) \$92</i> <i>SOLID WOOD SHELVES (EACH) \$28</i> <i>INSIDE DIMENSIONS: 21D x 33W x 69H</i>	24	36	72	class 125 cwt 280 lb cu ft 42	<b>3,602</b>	<b>3,889</b>
	<b>WD1272R-18</b> - __ <b>WD1272L-18</b> - __	wardrobe/coat storage hinged door (R) right hinge/left knob (L) left hinge/right knob <i>ADDITIONAL SHELVES (EACH) \$92</i> <i>SOLID WOOD SHELVES (EACH) \$28</i>	24	18	72	class 125 cwt 170 lb cu ft 23	<b>2,682</b>	<b>2,938</b>
	<b>AV12722F</b> - __	tv cabinet with pocket doors and pull out/swivel tv tray upper, lateral file below	24	36	72	class 125 cwt 340 lb cu ft 43	<b>5,957</b>	<b>6,433</b>
	<b>AV1272HW</b> - __	tv cabinet with pocket doors and pull out/swivel tv tray upper, hinged doors with one adjustable shelf below <i>ADDITIONAL SHELVES (EACH) \$92</i> <i>SOLID WOOD SHELVES (EACH) \$28</i>	24	36	72	class 125 cwt 290 lb cu ft 43	<b>5,754</b>	<b>6,217</b>
	<b>4FD1260</b> - __	lateral file/four drawers two drawers side by side under common top letter and legal capacity anti-tip locking mechanism	20	60	29	class 125 cwt 225 lb cu ft 26	<b>2,920</b>	<b>3,190</b>
[ QS ] 	<b>2FD1230</b> - __ Quick Ship available in 25M mahogany or 25C cherry	lateral file letter and legal capacity anti-tip locking mechanism	20	30	29	class 125 cwt 100 lb cu ft 13	<b>1,460</b>	<b>1,596</b>
	<b>MP122F</b> - __	mobile pedestal file/file with locking casters and no tip mechanism use under 29" surface black top	18.9	16.6	27.3	class 125 cwt 75 lb cu ft 6	<b>1,217</b>	<b>1,315</b>
	<b>MP123D</b> - __	mobile pedestal box/box/file with locking casters and no tip mechanism use under 29" surface black top	18.9	16.6	27.3	class 125 cwt 75 lb cu ft 6	<b>1,232</b>	<b>1,331</b>
	<b>BW1271</b> - __	double bookcase wood doors two adjustable shelves in each side freestanding with base <i>ADDITIONAL SHELVES (EACH) \$92</i> <i>SOLID WOOD SHELVES (EACH) \$28</i>	17	71	47.5	class 125 cwt 235 lb cu ft 41	<b>3,538</b>	<b>3,823</b>

laminate tops only

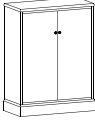
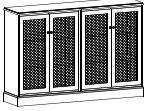
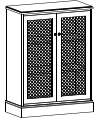
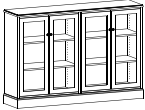
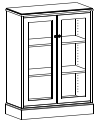
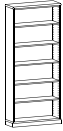
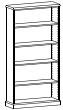
**3L-P** saddle on walnut laminate  
**4L-P** dark mahogany on walnut laminate  
**25M-P** mahogany on walnut laminate  
**25C-P** cherry on walnut laminate



	model number	description	d	w	h	freight	list \$ zone 1	list \$ zone 2
	<b>BW1236</b> - __	bookcase wood doors two adjustable shelves freestanding with base  <i>ADDITIONAL SHELVES (EACH) \$92</i> <i>SOLID WOOD SHELVES (EACH) \$28</i>	17	36	47.5	class 125 cwt 120 lb cu ft 21	<b>1,814</b>	<b>1,958</b>
	<b>BG1271</b> - __	double bookcase wire grill doors two adjustable shelves in each side freestanding with base  <i>ADDITIONAL SHELVES (EACH) \$92</i> <i>SOLID WOOD SHELVES (EACH) \$28</i>	17	71	47.5	class 125 cwt 235 lb cu ft 41	<b>4,238</b>	<b>4,618</b>
	<b>BG1236</b> - __	bookcase wire grill doors two adjustable shelves freestanding with base  <i>ADDITIONAL SHELVES (EACH) \$92</i> <i>SOLID WOOD SHELVES (EACH) \$28</i>	17	36	47.5	class 125 cwt 120 lb cu ft 21	<b>2,211</b>	<b>2,389</b>
	<b>BD1271</b> - __	double bookcase glass doors two adjustable shelves in each side freestanding with base  <i>ADDITIONAL SHELVES (EACH) \$92</i> <i>SOLID WOOD SHELVES (EACH) \$28</i>	17	71	47.5	class 125 cwt 235 lb cu ft 41	<b>3,709</b>	<b>4,006</b>
	<b>BD1236</b> - __	bookcase glass doors two adjustable shelves freestanding with base  <i>ADDITIONAL SHELVES (EACH) \$92</i> <i>SOLID WOOD SHELVES (EACH) \$28</i>	17	36	47.5	class 125 cwt 120 lb cu ft 21	<b>1,899</b>	<b>2,132</b>
[ QS ] 	<b>BC1284</b> - __ <small>Quick Ship available in 25M mahogany or 25C cherry</small>	bookcase four adjustable shelves one fixed shelf in center  <i>ADDITIONAL SHELVES (EACH) \$92</i> <i>SOLID WOOD SHELVES (EACH) \$28</i>	12	36	84	class 125 cwt 145 lb cu ft 28	<b>1,814</b>	<b>1,956</b>
[ QS ] 	<b>BC1272</b> - __ <small>Quick Ship available in 25M mahogany or 25C cherry</small>	bookcase three adjustable shelves one fixed shelf in center  <i>ADDITIONAL SHELVES (EACH) \$92</i> <i>SOLID WOOD SHELVES (EACH) \$28</i>	12	36	72	class 125 cwt 135 lb cu ft 24	<b>1,624</b>	<b>1,756</b>
	<b>BC1260</b> - __	bookcase two adjustable shelves one fixed shelf in center  <i>ADDITIONAL SHELVES (EACH) \$92</i> <i>SOLID WOOD SHELVES (EACH) \$28</i>	12	36	60	class 125 cwt 110 lb cu ft 20	<b>1,354</b>	<b>1,461</b>
[ QS ] 	<b>BC1248</b> - __ <small>Quick Ship available in 25M mahogany or 25C cherry</small>	bookcase one adjustable shelf one fixed shelf  <i>ADDITIONAL SHELVES (EACH) \$92</i> <i>SOLID WOOD SHELVES (EACH) \$28</i>	12	36	48	class 125 cwt 96 lb cu ft 16	<b>1,155</b>	<b>1,245</b>

top P laminate top

edge





	model number	description	d	w	h	freight	list \$ zone 1	list \$ zone 2
	BC1236 - __	bookcase two adjustable shelves  <i>ADDITIONAL SHELVES (EACH) \$92</i> <i>SOLID WOOD SHELVES (EACH) \$28</i>	12	36	36	class 125 cwt 85 lb cu ft 12	983	1,061
	BC1230 - __	bookcase one adjustable shelf  <i>ADDITIONAL SHELVES (EACH) \$92</i> <i>SOLID WOOD SHELVES (EACH) \$28</i>	12	36	30	class 125 cwt 80 lb cu ft 11	864	934

magnus  
1200

laminated tops only  
**3L-P** saddle on walnut laminate  
**4L-P** dark mahogany on walnut laminate  
**25M-P** mahogany on walnut laminate  
**25C-P** cherry on walnut laminate



	model number	description	d	w	h	freight	list \$ zone 1	list \$ zone 2
	TD1272 - __	desk top transaction counter for use with 72" desk only	12	72	15.25	class 125 cwt 90 lb cu ft 6	1,118	1,202
	TD1266 - __	desk top transaction counter for use with 66" desk only	12	66	15.25	class 125 cwt 84 lb cu ft 6	1,118	1,202
	TD126630 - __	desk top transaction counter for use with 30" x 66" desk only	12	66	15.25	class 125 cwt 84 lb cu ft 6	1,118	1,202
	TD1260 - __	desk top transaction counter for use with 30" x 60" desk only	12	60	15.25	class 125 cwt 84 lb cu ft 6	1,118	1,202
	TM1272R - __	desk top transaction/reception gallery for use with executive height 72" "I" unit  <i>GALLERY 84"D x 72"W x 14"H</i>	12	72	15.25	class 125 cwt 100 lb cu ft 6	1,653	1,777
	TM1272L - __	desk top transaction/reception gallery for use with executive height 72" "I" unit  <i>GALLERY 84"D x 72"W x 14"H</i>	12	72	15.25	class 125 cwt 100 lb cu ft 6	1,653	1,777
	TM1266R - __	desk top transaction/reception gallery for use with executive height 66" "I" unit  <i>GALLERY 84"D x 66"W x 14"H</i>	12	66	15.25	class 125 cwt 94 lb cu ft 6	1,653	1,777
	TM1266L - __	desk top transaction/reception gallery for use with executive height 66" "I" unit  <i>GALLERY 84"D x 66"W x 14"H</i>	12	66	15.25	class 125 cwt 94 lb cu ft 6	1,653	1,777
	TM126630R - __	desk top transaction/reception gallery for use with 30" x 66" "I" unit  <i>GALLERY 78"D x 66"W x 14"H</i>	12	66	15.25	class 125 cwt 94 lb cu ft 6	1,653	1,777



top

P laminate top

edge



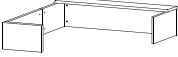
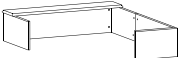
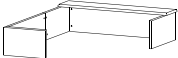
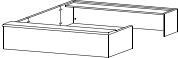
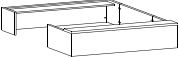
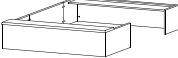
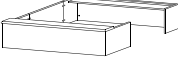
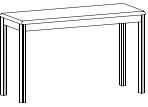

	model number	description	d	w	h	freight	list \$ zone 1	list \$ zone 2
	TM126630L - __	desk top transaction/reception gallery for use with 30" x 66" "I" unit  GALLERY 78"D x 66"W x 14"H	12	66	15.25	class 125 cwt 94 lb cu ft 6	1,653	1,777
	TM1260R - __	desk top transaction/reception gallery for use with 60" right "I" unit  GALLERY 78"D x 60"W x 14"H	12	60	15.25	class 125 cwt 90 lb cu ft 6	1,653	1,777
	TM1260L - __	desk top transaction/reception gallery for use with 60" left "I" unit  GALLERY 78"D x 60"W x 14"H	12	60	15.25	class 125 cwt 90 lb cu ft 6	1,653	1,777
	TU1272R - __	desk top transaction/reception gallery for use with 72" right executive "u" unit only  GALLERY 104"D x 72"W x 14"H	12	72	15.25	class 125 cwt 150 lb cu ft 8	2,234	2,406
	TU1272L - __	desk top transaction/reception gallery for use with 72" left executive "u" unit only  GALLERY 104"D x 72"W x 14"H	12	72	15.25	class 125 cwt 150 lb cu ft 8	2,234	2,406
	TU1266R - __	desk top transaction/reception gallery for use with 66" right executive "u" unit only  GALLERY 104"D x 66"W x 14"H	12	66	15.25	class 125 cwt 140 lb cu ft 8	2,234	2,406
	TU1266L - __	desk top transaction/reception gallery for use with 66" left executive "u" unit only  GALLERY 104"D x 66"W x 14"H	12	66	15.25	class 125 cwt 140 lb cu ft 8	2,234	2,406
[ QS ] 	T1248-29 - __ Quick Ship available in 25M mahogany or 25C cherry	sofa table  CAN SHIP UPS	18	48	29	class 85 kd cwt 50 lb cu ft 3	785	849
[ QS ] 	T1248 - __ Quick Ship available in 25M mahogany or 25C cherry	lamp table  CAN SHIP UPS	18	48	17	class 85 kd cwt 40 lb cu ft 3	565	608

laminite tops only  
 3L-P saddle on walnut laminate  
 4L-P dark mahogany on walnut laminate  
 25M-P mahogany on walnut laminate  
 25C-P cherry on walnut laminate

magnus 1200

	model number	description	d	w	h	freight	list \$ zone 1	list \$ zone 2
[ QS ] 	<b>ET1228 - _</b> Quick Ship available in 25M mahogany or 25C cherry	end table <i>CAN SHIP UPS</i>	28	15	22	class 150 kd cwt 26 lb cu ft 2	<b>435</b>	<b>468</b>
	<b>ET1228S - _</b>	end table with shelf <i>CAN SHIP UPS</i>	28	15	22	class 85 kd cwt 30 lb cu ft 2	<b>579</b>	<b>627</b>
	<b>T1230-29 - _</b>	lamp table <i>CAN SHIP UPS</i>	30	30	29	class 85 cwt 50 lb cu ft 3	<b>735</b>	<b>796</b>
[ QS ] 	<b>T1230-22 - _</b> Quick Ship available in 25M mahogany or 25C cherry	lamp table <i>CAN SHIP UPS</i>	30	30	22	class 85 cwt 45 lb cu ft 3	<b>516</b>	<b>558</b>
	<b>T1230-17 - _</b>	lamp table <i>CAN SHIP UPS</i>	30	30	17	class 85 cwt 46 lb cu ft 3	<b>476</b>	<b>513</b>
	<b>T1224-22 - _</b>	lamp table <i>CAN SHIP UPS</i>	24	24	22	class 85 cwt 46 lb cu ft 3	<b>468</b>	<b>508</b>
	<b>T1230S - _</b>	lamp table with shelf <i>CAN SHIP UPS</i>	30	30	22	class 85 cwt 64 lb cu ft 3	<b>775</b>	<b>837</b>
	<b>W1214 - _</b>	waste receptacle <i>CAN SHIP UPS</i>	14	14	14.5	class 200 cwt 9 lb cu ft 2	<b>343</b>	<b>369</b>
[ QS ] 	<b>CO1266 - _</b> Quick Ship available in 25M mahogany or 25C cherry	costumer <i>CAN SHIP UPS</i>	66			class 85 cwt 10 lb cu ft .5	<b>202</b>	<b>216</b>

top P laminate top

edge



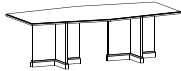
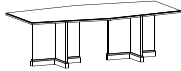
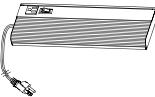

	model number	description	d	w	h	freight	list \$ zone 1	list \$ zone 2
	<b>CW42-QA</b>	circular laminate top with wood edge, Queen Ann Base	42 dia			cwt 80 lb	<b>2,012</b>	<b>2,102</b> as shown
			<small>BASE:</small> 34	34	27.75			
	<b>WW9648-XB18-30</b> <small>2 EACH FOR ABOVE TOP</small>	wedge top with wood x style base laminate top/wood edge with empire series styling	96	48		cwt 185 lb	<b>3,566</b>	<b>3,842</b> as shown
			36	36	27.75	cwt 70 lb ea		
	<b>RW144</b> <b>SB18-29</b> <small>3 FOR ABOVE TOP</small>	regular top with wood base 2 piece laminate top/wood edge wood slab base with empire series styling	144	48		cwt 185 lb	<b>4,014</b>	<b>4,244</b> as shown
			4	29	27.75			
	<b>TL24</b>	task light for use with overhead storage units <i>FIELD INSTALLED ONLY</i>	7	24	2	class 100 cwt 11 lb cu ft 1	<b>335</b>	<b>364</b>

magnus  
1200

**laminate**  
tops only

**3L-P** saddle on walnut laminate  
**4L-P** dark mahogany on walnut laminate  
**25M-P** mahogany on walnut laminate  
**25C-P** cherry on walnut laminate

# inwood

OFFICE  
ENVIRONMENTS

## price list

effective 01 january 2012

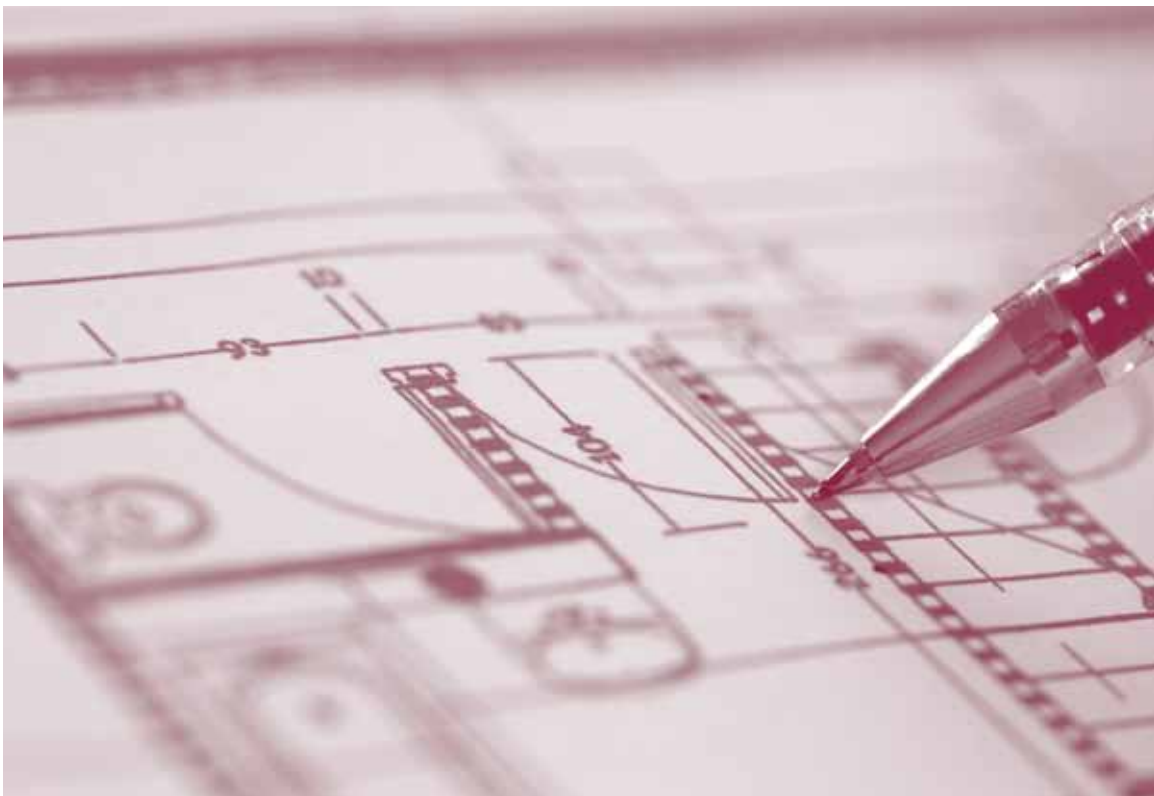

account # \_\_\_\_\_  
discount \_\_\_\_\_  
zone \_\_\_\_\_  
c.s.r. \_\_\_\_\_  
sales rep. \_\_\_\_\_

## conference

[click here for warranty  
and terms information](#)

zones one and two



# inwood

OFFICE  
ENVIRONMENTS

---



conference

### conference furnishings specifications

#### materials:

All wood is thoroughly air and kiln dried to a moisture content not to exceed 8% at the time of assembly.

#### veneers:

All exposed surfaces are plain sliced Cherry, American Black Walnut, or White Maple. Veneers are carefully bookmatched and balanced. All drawer fronts, doors, end panels, modesty panels, and bases are vertical grains.

#### top work surfaces:

Wood Veneer tops are 1 1/4" thick, 5-ply construction; consisting of 1/40" thick veneer work surface and a Gator-ply backing. The top core material is a 45 lb density flake board. Plastic laminate tops are 1 1/4" thick, 3-ply construction; consisting of a high pressure laminate work surface and a 45 lb density flake board core. The underside of the top has a smooth surface Gator-Ply backing sheet. Top rims are 3/4" hardwood with the choice of top edge shape on all four sides.

#### modesty panels:

3/4" thick, 3-ply construction with a vertical bookmatched veneer on exposed surfaces and a 45 lb density flake board core.

#### construction:

Uses a mortise and tenon and glue to join panels and modesty panels. All joints are reinforced with glue blocks. Each pedestal has a lock and is keyed alike.

#### hinge doors:

Door fronts are 3/4" thick, 3-ply construction with vertical bookmatched veneer. Drawer edges are veneered on top and sides with matching wood veneer.

#### locking:

Upcharge for locking hinge doors.

#### finish:

All Inwood finishes are catalyzed varnish and have excellent durability. Our multi-step finishes leave a beautiful natural look to the furniture, and are available in the following finishes: (88M-W) mahogany on cherry, (MB-W) mocha on birch, (NB-W) natural on birch, (CB-W) cherry on birch, (3L-W) saddle on walnut, (2KL-W) sepia on walnut, (4L-W) dark mahogany on walnut, (25M-W) mahogany on walnut, (25B-W) ebony on walnut, (25C-W) cherry on walnut, (2ML-W) natural maple on maple, (3ML-W) light maple on maple, (4ML-W) medium maple on maple, (5ML-W) cherry on maple, (1NC-W) natural cherry on cherry, (2HC-W) honey cherry on cherry, (6LC-W) light cherry on cherry, (7MC-W) medium cherry on cherry, (8DC-W) dark cherry on cherry, (9BC-W) burgundy cherry on cherry

### conference table pads:

Black folding leatherette pads with velvet bottom pads that are custom made for your table size. The pads are washable and protect the table top from abuse or stains while in use and when removed allow you to display the uncompromised beauty of your wood table.

96" x 48"	\$446 list all shapes
120" x 48"	\$602 list all shapes
144" x 48"	\$759 list all shapes
	add \$43 per grommet hole

Call customer service for details.

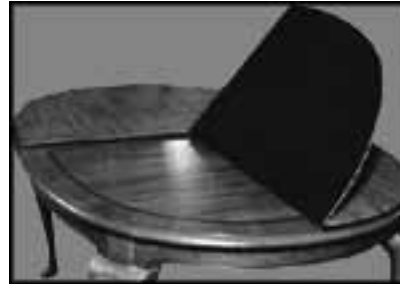

smaller than 96"x48"

grain direction for veneer tops

96"x48" and larger

grain direction for laminate tops

all table sizes

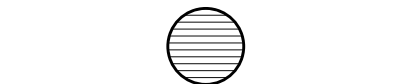
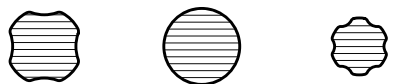
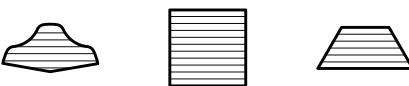
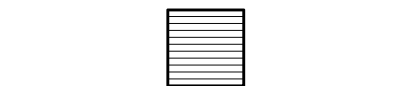
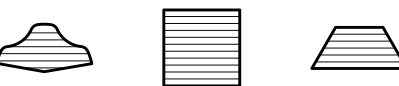
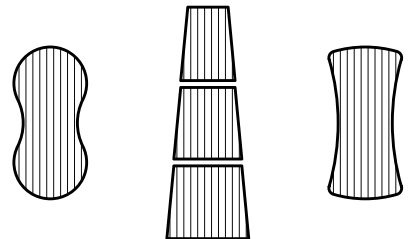
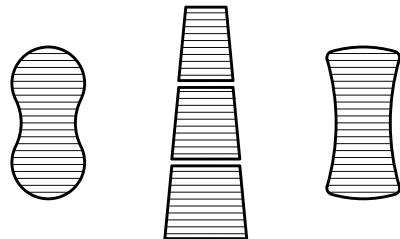
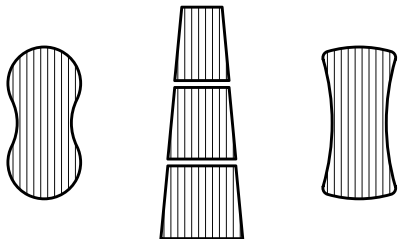
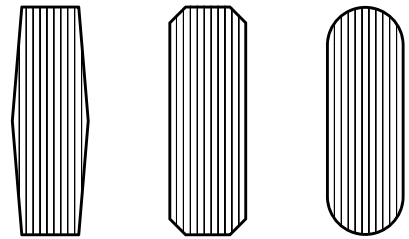
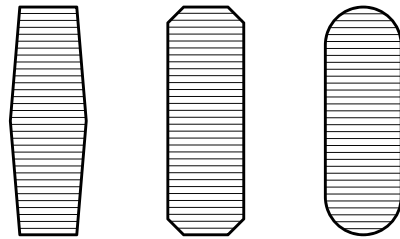
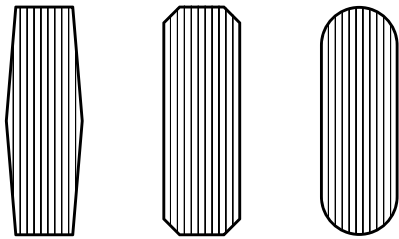
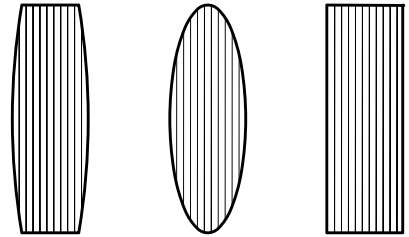
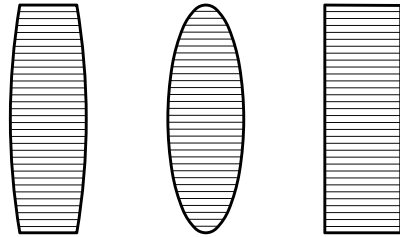
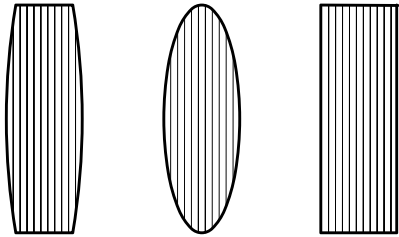



The following suggested seating accommodations are based on the average chair width of 30". These figures may vary depending on the end users chair width, style, and base selection.



**manta** seating  
48" 2

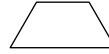

**trapezoid** seating  
48" 2-3  
60" 2-3



**half moon** seating  
36" x 18" 2  
42" x 21" 2  
48" x 24" 2  
60" x 30" 3

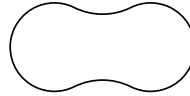

**peanut** seating  
72" x 40" 6  
96" x 46" 8  
120" x 48" 10  
144" x 48" 12



42" 3

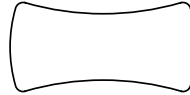

72" x 46" 6  
96" x 46" 8  
120" x 48" 10  
144" x 48" 12



**clover** seating  
48" dia 4

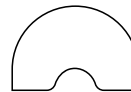

72" x 48" 7



**flower** seating  
60" dia 5-6



36" dia 3  
42" dia 4  
48" dia 4  
60" dia 5-6

**planning:**

The following suggested seating accommodations are based on the average chair width of 30". These figures may vary depending on the end users chair width, style, and base selection.



rectangle	seating
36" x 24"	2
48" x 24"	2
60" x 24"	4
60" x 36"	6
72" x 24"	4
72" x 36"	6
96" x 36"	8
96" x 48"	8
96" x 60"	10
120" x 48"	8-10
120" x 60"	12
144" x 48"	12
168" x 60"	12



36" sq	4
42" sq	4
48" sq	4
60" sq	6



72" x 36"	6
96" x 48"	8
120" x 48"	10
144" x 48"	12

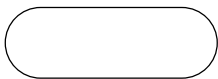

72" x 36"	6
96" x 48"	8
120" x 48"	8
144" x 48"	8-10



wedge	seating
72" x 36"	6
96" x 48"	8
120" x 48"	8
144" x 48"	8-10









octagonal	seating
72" x 36"	6
96" x 48"	8
120" x 48"	8
144" x 48"	8-10



elliptical	seating
72" x 36"	4-5
96" x 48"	6
120" x 48"	8-10
144" x 48"	12

## 4HW1974D-36-\_\_-W

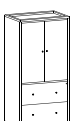
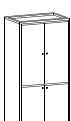
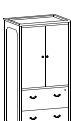
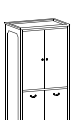
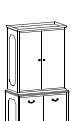
unit identification (type) & top dimension - chassis finish - top finish - top material  
(may not apply to all products in series)



	model number		d	w	h	freight	list \$ zone 1	zone 2
	<b>HW26722F</b> - __	hinged door cabinet two adjustable shelves upper lateral file below progeny series detailing ADDITIONAL SHELVES (EACH) <b>\$92</b> SOLID WOOD SHELVES (EACH) <b>\$28</b>	24	36	72	class 125 cwt 320 lb cu ft 43	<b>5,199</b>	<b>5,615</b>
	<b>HW2672HW</b> - __	hinged door cabinet (upper and lower) two adjustable shelves above one adjustable shelf below progeny series detailing ADDITIONAL SHELVES (EACH) <b>\$92</b> SOLID WOOD SHELVES (EACH) <b>\$28</b>	24	36	72	class 125 cwt 270 lb cu ft 43	<b>4,980</b>	<b>5,384</b>
	<b>HW25722F</b> - __ - __ - __ - __	hinged door cabinet two adjustable shelves upper lateral file lower trek series detailing ADDITIONAL SHELVES (EACH) <b>\$92</b> SOLID WOOD SHELVES (EACH) <b>\$28</b>	24	36	72	class 125 cwt 320 lb cu ft 43	<b>5,199</b>	<b>5,615</b>
	<b>HW2572HW</b> - __ - __ - __ - __	hinged door cabinet (upper and lower) two adjustable shelves above one adjustable shelf below trek series detailing ADDITIONAL SHELVES (EACH) <b>\$92</b> SOLID WOOD SHELVES (EACH) <b>\$28</b>	24	36	72	class 125 cwt 270 lb cu ft 43	<b>4,980</b>	<b>5,384</b>
	<b>HW23722F</b> - __ - __	hinged door cabinet two adjustable shelves upper lateral file below ovation/bravo series detailing SPECIFY EDGE OPTION ADDITIONAL SHELVES (EACH) <b>\$92</b> SOLID WOOD SHELVES (EACH) <b>\$28</b>	24	36	72	class 125 cwt 320 lb cu ft 43	<b>5,199</b>	<b>5,615</b>
	<b>HW21722F</b> - __ - __						<b>5,199</b>	<b>5,615</b>
	<b>HW2372HW</b> - __ - __	hinged door cabinet (upper and lower) two adjustable shelves above one adjustable shelf below ovation/bravo series detailing SPECIFY EDGE OPTION ADDITIONAL SHELVES (EACH) <b>\$92</b> SOLID WOOD SHELVES (EACH) <b>\$28</b>	24	36	72	class 125 cwt 270 lb cu ft 43	<b>4,980</b>	<b>5,384</b>
	<b>HW2172HW</b> - __ - __						<b>4,980</b>	<b>5,384</b>
	<b>HW19722F</b> - __	hinged door cabinet two adjustable shelves upper lateral file below monticello/empire series detailing ADDITIONAL SHELVES (EACH) <b>\$92</b> SOLID WOOD SHELVES (EACH) <b>\$28</b>	24	36	72	class 125 cwt 320 lb cu ft 43	<b>5,199</b>	<b>5,615</b>
	<b>HW18722F</b> - __						<b>5,199</b>	<b>5,615</b>
	<b>HW1972HW</b> - __	hinged door cabinet (upper and lower) two adjustable shelves above one adjustable shelf below monticello/empire series detailing ADDITIONAL SHELVES (EACH) <b>\$92</b> SOLID WOOD SHELVES (EACH) <b>\$28</b>	24	36	72	class 125 cwt 270 lb cu ft 43	<b>4,980</b>	<b>5,384</b>
	<b>HW1872HW</b> - __						<b>4,980</b>	<b>5,384</b>
	<b>HWHW1937</b> - __ - __	hinged door cabinet (upper and lower) two adjustable shelves above one adjustable shelf below monticello/empire series detailing ADDITIONAL SHELVES (EACH) <b>\$92</b> SOLID WOOD SHELVES (EACH) <b>\$28</b>	20	37.5	72.5	class 125 cwt 290 lb cu ft 43	<b>3,888 W</b> <b>3,598 P</b>	<b>4,193 W</b> <b>3,883 P</b>
	<b>HWHW1837</b> - __ - __						<b>3,559 W</b> <b>3,267 P</b>	<b>3,841 W</b> <b>3,529 P</b>

conference

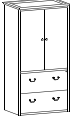
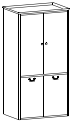
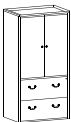
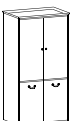
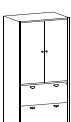
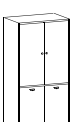
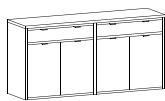
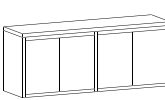

top

**P** laminate top  
**W** veneer top

for edge availability refer to complete line offering

	model number	description	d	w	h	freight	zone 1	zone 2
	HW13722F - __	hinged door cabinet two adjustable shelves upper lateral file below oxford series detailing ADDITIONAL SHELVES (EACH) \$92 FOR CORNICE TOP (LIST UPCHARGE) \$202 SOLID WOOD SHELVES (EACH) \$28	24	36	72	class 125 cwt 320 lb cu ft 43	5,199	5,615
	HW1372HW - __	hinged door cabinet (upper and lower) two adjustable shelves above one adjustable shelf below oxford series detailing ADDITIONAL SHELVES (EACH) \$92 FOR CORNICE TOP (LIST UPCHARGE) \$202 SOLID WOOD SHELVES (EACH) \$28	24	36	72	class 125 cwt 270 lb cu ft 43	4,980	5,384
	HW12722F - __	hinged door cabinet two adjustable shelves upper lateral file below magnus series detailing ADDITIONAL SHELVES (EACH) \$92 SOLID WOOD SHELVES (EACH) \$28	24	36	72	class 125 cwt 320 lb cu ft 43	5,199	5,615
	HW1272HW - __	hinged door cabinet (upper and lower) two adjustable shelves above one adjustable shelf below magnus series detailing ADDITIONAL SHELVES (EACH) \$92 SOLID WOOD SHELVES (EACH) \$28	24	36	72	class 125 cwt 270 lb cu ft 43	4,980	5,384
	HW11722F - __	hinged door cabinet two adjustable shelves upper lateral file below ebb series detailing ADDITIONAL SHELVES (EACH) \$92 SOLID WOOD SHELVES (EACH) \$28	24	36	72	class 125 cwt 320 lb cu ft 43	5,199	5,615
	HW1172HW - __	hinged door cabinet (upper and lower) two adjustable shelves above one adjustable shelf below ebb series detailing ADDITIONAL SHELVES (EACH) \$92 SOLID WOOD SHELVES (EACH) \$28	24	36	72	class 125 cwt 270 lb cu ft 43	4,980	5,384
	4HW2374D-36 - __ - - - - 4HW2174D-36 - __ - - - -	serving height credenza two sets of hinged doors one adjustable shelf on each side two drawers above, all black pulls ovation/bravo series detailing SPECIFY EDGE OPTION ADDITIONAL SHELVES (EACH) \$92 SOLID WOOD SHELVES (EACH) \$28	20	72	36	class 125 cwt 405 lb cu ft 37	4,561 W  3,992 P	4,928 W  4,307 P
	4HW2374 - __ - __ - - - 4HW2174 - __ - __ - - -	hinged door cabinets 2-hinged door cabinets under common top with one adjustable shelf on each side ovation/bravo series detailing SPECIAL EDGE OPTION ADDITIONAL SHELVES (EACH) \$92 SOLID WOOD SHELVES (EACH) \$28	20	72	29	class 125 cwt 350 lb cu ft 32  <i>INSIDE DIMENSIONS</i> <i>EACH CABINET:</i> 18 35 27	3,920 W  3,330 P	4,222 W  3,582 P
	4HW1974D-36 - __ - - - 4HW1874D-36 - __ - - -	serving height credenza two sets of hinged doors one adjustable shelf on each side two drawers above, traditional brass pulls monticello/empire series detailing WALNUT VENEER ONLY BRACKET BASE UNIT NOT AVAILABLE ADDITIONAL SHELVES (EACH) \$92 SOLID WOOD SHELVES (EACH) \$28	20	73	36	class 125 cwt 405 lb cu ft 37	4,473 W 4,041 P  4,147 W 3,716 P	4,804 W 4,339 P  4,479 W 4,012 P

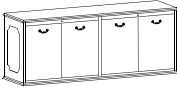
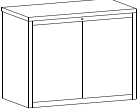
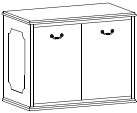
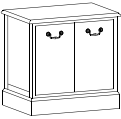
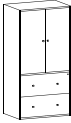
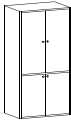

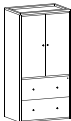

for a complete listing of finishes see pages 482-483

	model number		d	w	h	freight	list \$ zone 1	zone 2
	4HW1974 - _ - _	hinged door cabinets 2-hinged door cabinets under common top with one adjustable shelf on each side monticello/empire series detailing and finishes	20	73	29	class 125 cwt 370 lb cu ft 32	<b>3,817 W</b> <b>3,373 P</b>	<b>4,114 W</b> <b>3,642 P</b>
	4HW1874 - _ - _	each cabinet 18 x 34.8 x 25.8 WALNUT VENEER ONLY BRACKET BASE UNIT NOT AVAILABLE ADDITIONAL SHELVES (EACH) \$92 SOLID WOOD SHELVES (EACH) \$28	INSIDE DIMENSIONS EACH CABINET: 19 34.8 25.8			<b>3,492 W</b> <b>3,046 P</b>	<b>3,764 W</b> <b>3,288 P</b>	
	HW2337 - _ - _ - _	hinged door cabinet wood doors, one adjustable shelf ovation/bravo series detailing and finishes	20	36	29	class 125 cwt 175 lb cu ft 16	<b>1,958 W</b>	<b>2,111 W</b>
	HW2137 - _ - _ - _	SPECIFY EDGE OPTION ADDITIONAL SHELVES (EACH) \$92 SOLID WOOD SHELVES (EACH) \$28	INSIDE DIMENSIONS EACH CABINET: 18 34.5 27			<b>1,665 P</b>	<b>1,793 P</b>	
	HW1937 - _ - _	hinged door cabinet wood doors, one adjustable shelf monticello/empire series detailing and finishes	20	37	29	class 125 cwt 185 lb cu ft 16	<b>1,908 W</b> <b>1,618 P</b>	<b>2,056 W</b> <b>1,746 P</b>
	HW1837 - _ - _	WALNUT VENEER ONLY BRACKET BASE UNIT NOT AVAILABLE ADDITIONAL SHELVES (EACH) \$92 SOLID WOOD SHELVES (EACH) \$28	INSIDE DIMENSIONS EACH CABINET: 19 34.8 25.8			<b>1,745 W</b> <b>1,454 P</b>	<b>1,883 W</b> <b>1,570 P</b>	
	HW1230 - _ - _	hinged door cabinet two wood doors, one adjustable shelf magnus series detailing and finishes	20	30	29	class 125 cwt 110 lb cu ft 13	<b>1,236 P</b>	<b>1,305 P</b>
		WALNUT VENEER ONLY ADDITIONAL SHELVES (EACH) \$92 SOLID WOOD SHELVES (EACH) \$28	INSIDE DIMENSIONS EACH CABINET: 16 26 21.8					
	AV26722F - _	tv cabinet upper pocket doors, pull-out swivel tv tray lateral file below progeny series detailing and finishes	24	36	72	class 125 cwt 340 lb cu ft 43	<b>5,957</b>	<b>6,433</b>
	AV2672HW - _	tv cabinet upper pocket doors, pull-out swivel tv tray hinged door cabinet below one adjustable shelf progeny series detailing and finishes	24	36	72	class 125 cwt 290 lb cu ft 43	<b>5,754</b>	<b>6,217</b>
		ADDITIONAL SHELVES (EACH) \$92 SOLID WOOD SHELVES (EACH) \$28						
	AV25722F - _ - _ - _ - - -	tv cabinet upper pocket doors, pull-out swivel tv tray lateral file below trek series detailing and finishes	24	36	72	class 125 cwt 340 lb cu ft 43	<b>5,957</b>	<b>6,433</b>
	AV2572HW - _ - _ - _ - - -	tv cabinet upper pocket doors, pull-out swivel tv tray hinged door cabinet below one adjustable shelf trek series detailing and finishes	24	36	72	class 125 cwt 290 lb cu ft 43	<b>5,754</b>	<b>6,217</b>
		ADDITIONAL SHELVES (EACH) \$92 SOLID WOOD SHELVES (EACH) \$28						
	AV23722F - _ - _ - _	tv cabinet upper pocket doors, pull-out swivel tv tray lateral file below ovation/bravo series detailing and finishes	24	36	72	class 125 cwt 340 lb cu ft 43	<b>5,957</b>	<b>6,433</b>
	AV21722F - _ - _ - _	SPECIFY EDGE OPTION				<b>5,957</b>	<b>6,433</b>	

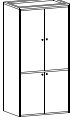

top

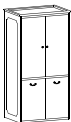
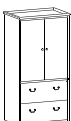
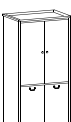
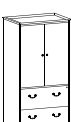
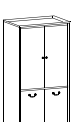
P laminate top  
W veneer top

for edge availability refer to complete line offering



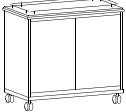

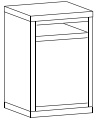
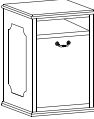
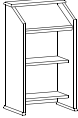
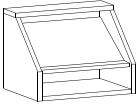
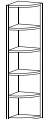
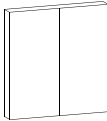
	model number	description	d	w	h	freight	zone 1	zone 2
	AV2372HW - _ - _	tv cabinet upper pocket doors, pull-out swivel tv tray hinged door cabinet below one adjustable shelf	24	36	72	class 125 cwt 290 lb cu ft 43	5,754	6,217
	AV2172HW - _ - _	ovation/bravo series detailing and finishes <i>SPECIFY EDGE OPTION</i> ADDITIONAL SHELVES (EACH) \$92 SOLID WOOD SHELVES (EACH) \$28						
	AV19722F - _	tv cabinet upper pocket doors, pull-out swivel tv tray lateral file below	24	36	72	class 125 cwt 340 lb cu ft 43	5,957	6,433
	AV18722F - _	monticello/empire series detailing and finishes						
	AV1972HW - _	tv cabinet upper pocket doors, pull-out swivel tv tray hinged door cabinet below one adjustable shelf	24	36	72	class 125 cwt 290 lb cu ft 43	5,754	6,217
	AV1872HW - _	monticello/empire series detailing and finishes ADDITIONAL SHELVES (EACH) \$92 SOLID WOOD SHELVES (EACH) \$28						
	AV13722F - _	tv cabinet upper pocket doors, pull-out swivel tv tray lateral file below	24	36	72	class 125 cwt 340 lb cu ft 43	5,957	6,433
		oxford series detailing and finishes FOR CORNICE TOP (LIST UPCHARGE) \$202						
	AV1372HW - _	tv cabinet upper pocket doors, pull-out swivel tv tray hinged door cabinet below one adjustable shelf	24	36	72	class 125 cwt 290 lb cu ft 43	5,754	6,217
		oxford series detailing and finishes ADDITIONAL SHELVES (EACH) \$92 FOR CORNICE TOP (LIST UPCHARGE) \$202 SOLID WOOD SHELVES (EACH) \$28						
	AV12722F - _	tv cabinet upper pocket doors, pull-out swivel tv tray lateral file below	24	36	72	class 125 cwt 340 lb cu ft 43	5,957	6,433
		magnus series detailing and finishes						
	AV1272HW - _	tv cabinet upper pocket doors, pull-out swivel tv tray hinged door cabinet below one adjustable shelf	24	36	72	class 125 cwt 290 lb cu ft 43	5,754	6,217
		magnus series detailing and finishes ADDITIONAL SHELVES (EACH) \$92 SOLID WOOD SHELVES (EACH) \$28						
	AV11722F - _	tv cabinet upper pocket doors, pull-out swivel tv tray lateral file below	24	36	72	class 125 cwt 340 lb cu ft 43	5,957	6,433
		ebb series detailing and finishes						
	AV1172HW - _	tv cabinet upper pocket doors, pull-out swivel tv tray hinged door cabinet below one adjustable shelf	24	36	72	class 125 cwt 290 lb cu ft 43	5,754	6,217
		ebb series detailing and finishes ADDITIONAL SHELVES (EACH) \$92 SOLID WOOD SHELVES (EACH) \$28						

for a complete listing of finishes see pages 482-483

	model number		d	w	h	freight	list \$ zone 1	zone 2
	<b>AVC4536</b> - _ _	audio visual/computer teaching cart with casters <i>AVAILABLE IN ANY INWOOD FINISH</i>	26	35	45	class 125 cwt 135 lb cu ft 20  TOP SHELF: 26 35 .75  INNER SHELF: 25.25 33.5	<b>1,770</b>	<b>1,910</b>
	<b>SC2137</b> - _ _ - _ _	servicing cart with casters one adjustable shelf ovation/bravo series detailing <i>AVAILABLE IN ANY INWOOD LAMINATE FINISH</i> ADDITIONAL SHELVES (EACH) <b>\$92</b> SOLID WOOD SHELVES (EACH) <b>\$28</b>	20	36.8	30.5	class 125 cwt 185 lb cu ft 16	<b>2,440</b>	<b>2,636</b>
	<b>SC1937</b> - _ _ - _  <b>SC1837</b> - _ _ - _	servicing cart with casters one adjustable shelf monticello/empire series detailing <i>AVAILABLE IN HPL TOPS ONLY NOT AVAILABLE IN MAPLE OR CHERRY</i> ADDITIONAL SHELVES (EACH) <b>\$92</b> SOLID WOOD SHELVES (EACH) <b>\$28</b>	21	37.8	30.5	class 125 cwt 185 lb cu ft 16	<b>2,455 W</b>  <b>2,297 P</b>	<b>2,650 W</b>  <b>2,479 P</b>
	<b>TC2320</b> - _ _ - _ - _  <b>TC2120</b> - _ _ - _ - _	telephone cabinet one fixed shelf hinged door cabinet below ovation/bravo series detailing and finishes <i>SPECIFY EDGE OPTION</i>	19.2	19.2	29	class 125 cwt 85 lb cu ft 8	<b>1,375 W</b>  <b>1,190 P</b>	<b>1,487 W</b>  <b>1,284 P</b>
	<b>TC1920</b> - _ _ - _  <b>TC1820</b> - _ _ - _	telephone cabinet one fixed shelf hinged door cabinet below monticello/empire series detailing and finishes <i>AVAILABLE IN WALNUT FINISHES ONLY</i>	20	20	29	class 125 cwt 85 lb cu ft 8	<b>1,215 W</b> <b>1,028 P</b>  <b>1,197 W</b> <b>1,014 P</b>	<b>1,311 W</b> <b>1,110 P</b>  <b>1,294 W</b> <b>1,091 P</b>
	<b>FSL</b> - _ _ - _ - _	freestanding lectern <i>SPECIFY EDGE OPTION SELECT EDGE DETAIL TO MATCH SERIES AVAILABLE IN HPL TOPS ONLY AVAILABLE IN ANY INWOOD LAMINATE FINISH</i>	20	27	48	class 125 cwt 95 lb cu ft 19	<b>1,005</b>	<b>1,061</b>
	<b>CLS</b> - _ _ - _ - _	lectern stand use on table top or with CPU unit <i>SPECIFY EDGE OPTION SELECT EDGE DETAIL TO MATCH SERIES AVAILABLE IN HPL TOPS ONLY AVAILABLE IN ANY INWOOD LAMINATE FINISH</i>	22	30	20	class 125 cwt 50 lb cu ft 4	<b>983</b>	<b>1,099</b>
	<b>BR72</b> - _ _	radius bookcase 1/4 round <i>AVAILABLE IN ANY INWOOD FINISH</i>	16.5	16.5	72	class 125 cwt 90 lb cu ft 14	<b>1,068</b>	<b>1,155</b>
	<b>CVB42</b> - _ _	contemporary visual board melamine non-glare writing surface taupe fabric on tackboard surface (requires 1.25 yrd standard) <i>AVAILABLE IN ANY INWOOD FINISH</i>	4	42	42	class 125 cwt 90 lb cu ft 3	<b>2,102</b>	<b>2,264</b>

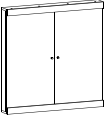
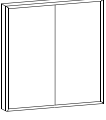
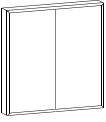
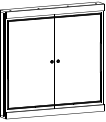
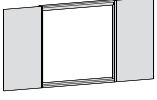
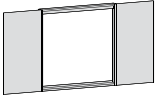
top  
P laminate top  
W veneer top

edge  
for edge availability refer to complete line offering









	model number	description	d	w	h	freight	zone 1	zone 2
	<b>CVBS42</b> - _	contemporary visual board with contemporary black knobs melamine non-glare writing surface doors slide out to the sides <i>AVAILABLE IN ANY INWOOD FINISH</i>	4	42	42	class 125 cwt 90 lb cu ft 3	<b>2,623</b>	<b>2,834</b>
	<b>RVB42</b> - _	contemporary visual board with radius trim melamine non-glare writing surface taupe fabric on tackboard surface (requires 1.25 yrd standard)	4	42	42	class 125 cwt 90 lb cu ft 3	<b>2,119</b>	<b>2,327</b>
<b>[ QS ]</b> 	<b>TVB42</b> - _ Quick Ship available in 25M mahogany or 25C cherry	traditional visual board with traditional trim melamine non-glare writing surface taupe fabric on tackboard surface (requires 1.25 yrd standard) <i>AVAILABLE IN ANY INWOOD FINISH EXCEPT MAPLE</i>	4	42	42	class 125 cwt 90 lb cu ft 3	<b>2,150</b>	<b>2,323</b>
	<b>TVBS42</b> - _	traditional visual board with traditional knobs and trim melamine non-glare writing surface doors slide out to the sides <i>AVAILABLE IN ANY INWOOD FINISH EXCEPT MAPLE</i>	4	42	42	class 125 cwt 90 lb cu ft 3	<b>2,656</b>	<b>2,869</b>
	<b>VBDS</b>	display screen for visual board				class cwt 5 lb cu ft 1	<b>242</b>	<b>259</b>
	<b>FRS</b>	field replaceable writing surface for any model visual board				class cwt 13 lb cu ft 4	<b>329</b>	<b>355</b>
	<b>PS72</b> - _	split pediment <i>TO BE USED ON 72" OVERHEAD UNIT AVAILABLE IN ANY INWOOD FINISH</i>				class 125 cwt 10 lb cu ft 1	<b>513</b>	<b>555</b>
	<b>PS66</b> - _	split pediment <i>TO BE USED ON 66" OVERHEAD UNIT AVAILABLE IN ANY INWOOD FINISH</i>				class 125 cwt 10 lb cu ft 1	<b>513</b>	<b>555</b>
	<b>PS42</b> - _	split pediment <i>TO BE USED ON 42" VISUAL BOARD AVAILABLE IN ANY INWOOD FINISH</i>				class 125 cwt 10 lb cu ft 1	<b>306</b>	<b>330</b>

for a complete listing of finishes see pages 482-483

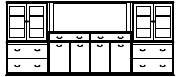

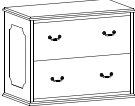
## 4HW1974D-36-\_\_-W

unit identification (type) & top dimension - **chassis finish** - **top finish** - **top material**  
(may not apply to all products in series)

	model number		d w h	freight	list \$ zone 1	zone 2
	PK72 - __	keyhole pediment TO BE USED ON 72" OVERHEAD UNIT AVAILABLE IN ANY INWOOD FINISH		class 125 cwt 10 lb cu ft 1	513	555
	PK66 - __	keyhole pediment TO BE USED ON 66" OVERHEAD UNIT AVAILABLE IN ANY INWOOD FINISH		class 85 cwt 10 lb cu ft 1	513	555
	PK42 - __	keyhole pediment TO BE USED ON 42" VISUAL BOARD AVAILABLE IN ANY INWOOD FINISH		class 85 cwt 10 lb cu ft 1	306	330
	PC4HW197226D-37 - __ - __ - __	serving height credenza two sets of hinged doors one adjustable shelf on each side two drawers above dhl pointman lift system installed	26 72 66.75	class 125 cwt 405 lb cu ft 37	5,959 W 5,555 P	6,435 W 6,001 P
	PC4HW187226D-37 - __ - __ - __	dhl pointman lift system installed FINISHES AVAILABLE IN ANY MONTICELLO FINISH	POINTMAN UNIT ONLY: 5.35 67.625 27.75		5,517 W 5,144 P	5,959 W 5,557 P
	HD1936R(L)-37 - __	hinged door cabinets glass doors two adjustable shelves	17 36 37.75	class 125 cwt 115 lb cu ft 21	2,061 W 2,061 P	2,225 W 2,225 P
	HD1836R(L)-37 - __	MUST ORDER BOTH (R) AND (L) FOR POINTMAN UNIT ADDITIONAL SHELVES (EACH) \$92			1,899 W 1,899 P	2,132 W 2,132 P
	2FD1937R(L) - __	two drawer lateral file standard anti-tip locking system must order both (r) and (l) for pointman unit	20 37 29	class 125 cwt 160 lb cu ft 16	2,312 W 2,011 P	2,496 W 2,171 P
	2FD1837R(L) - __	FINISHES AVAILABLE IN ANY MONTICELLO FINISH MUST ORDER BOTH FOR "POINT UNIT"			1,936 W 1,645 P	2,086 W 1,776 P
	PC4HW237226D-37 - __ - __ - __	serving height credenza two sets of hinged doors one adjustable shelf on each side two drawers above	26 72 66.75	cwt 405 lb cu ft 37	6,048	6,531
	PC4HW217226D-37 - __ - __ - __	dhl pointman lift system installed POINTMAN UNIT ONLY 5.36 x 67.625 x 27.75	POINTMAN UNIT ONLY: 5.35 67.625 27.75		5,506	5,946
	HD2336R(L)-37 - __	hinged door cabinet with glass doors two adjustable shelves	17 36 37.75	class 125 cwt 115 lb cu ft 21	2,572	2,761
	HD2136R(L)-37 - __	MUST ORDER BOTH (R) AND (L) FOR POINTMAN UNIT			2,572	2,761
	2FD2337R(L) - __ - __ - __	two drawer lateral file standard anti-tip locking system	20 37 29	class 125 cwt 160 lb cu ft 16	2,169	2,337
	2FD2137R(L) - __ - __ - __	MUST ORDER BOTH (R) AND (L) FOR POINTMAN UNIT			1,793	1,962

top









P laminate top  
W veneer top

for edge availability refer to complete line offering

	model number	description	d	w	h	freight	zone 1	zone 2
	<b>Nester -84</b>	Nester is the latch that allows the table to flip 84" requires a double latch Black standard color. Cannot be used with Genu-Fold mechanism  <i>TABLE/LEGS/MODESTY ORDERED SEPARATELY</i>				class 125 cwt 15 lb cu ft 1	<b>1,099</b>	<b>1,188</b>
	<b>Nester-72</b>	Nester is the latch that allows the table to flip 72" requires a double latch Black standard color. Cannot be used with Genu-Fold mechanism  <i>TABLE/LEGS/MODESTY ORDERED SEPARATELY</i>				class 125 cwt 15 lb cu ft 1	<b>1,099</b>	<b>1,188</b>
	<b>Nester-60</b>	Nester is the latch that allows the table to flip 60" requires a single latch Black standard color. Cannot be used with Genu-Fold mechanism  <i>TABLE/LEGS/MODESTY ORDERED SEPARATELY</i>				class 125 cwt 15 lb cu ft 1	<b>858</b>	<b>927</b>
	<b>Nester -48</b>	Nester is the latch that allows the table to flip 48" requires a single latch Black standard color. Cannot be used with Genu-Fold mechanism  <i>TABLE/LEGS/MODESTY ORDERED SEPARATELY</i>				class 125 cwt 15 lb cu ft 1	<b>858</b>	<b>927</b>
	<b>Nester-MH</b>	Modesty Hinge for Nester Hinge only for any size Nester (pr)				class cwt lb cu ft	<b>161</b>	<b>174</b>
	<b>Nester-84M</b>	84" Modesty panel for Nester  <i>SPECIFY FINISH</i>				class cwt lb cu ft	<b>602</b>	<b>650</b>
	<b>Nester-72M</b>	72" Modesty panel for Nester  <i>SPECIFY FINISH</i>				class cwt lb cu ft	<b>493</b>	<b>531</b>
	<b>Nester-60M</b>	60" Modesty panel for Nester  <i>SPECIFY FINISH</i>				class cwt lb cu ft	<b>374</b>	<b>404</b>
	<b>Nester-48M</b>	48" Modesty panel for Nester  <i>SPECIFY FINISH</i>				class cwt lb cu ft	<b>236</b>	<b>254</b>

for a complete listing of finishes see pages 482-483









base model AL - __	base model LB4 - __ LB2 - __	base model CC-20 - __ CC-26 - __	base model CC-34 - __	base model CX-26 - __ CX-38 - __	base model CX-48 - __	base model PDB-20 - __ PDB-24 - __ PDB-32 - __	LT set
-----------------------	------------------------------------	--	--------------------------	--	--------------------------	---	--------

	model number		base qty		base qty		base qty		base qty		base qty		base qty	
rectangle 	R _ 3624	4	4	2	-	-	-	-	-	-	-	-	1	
	R _ 4824	4	4	2	-	-	-	-	-	-	-	-	1	
	R _ 6024	4	4	2	-	-	-	-	-	-	-	-	1	
	R _ 7224	4	4	2	-	-	-	-	-	-	-	-	1	
	R _ 6036	4	4	4	-	2	-	-	-	-	-	-	1	
	R _ 7236	4	4	4	-	2	-	-	-	-	-	-	1	
	R _ 9636	-	4	-	-	2	-	-	-	-	2	-	1	
	R _ 9648	-	4	-	-	-	2	-	-	-	-	-	-	
	R _ 120	-	6	-	-	-	3	-	-	-	-	-	-	
	R _ 144	-	6	-	-	-	3	-	-	-	-	-	-	
	R _ 168	-	-	-	-	-	4	-	-	-	-	-	-	
	R _ 9660	-	4	-	-	-	2	-	-	-	-	-	-	
	R _ 12060	-	6	-	-	-	3	-	-	-	-	-	-	
	R _ 16860	-	-	-	-	-	4	-	-	-	-	-	-	
	RT _ 7236	4	4	4	-	2	-	-	-	-	2	-	-	
	RT _ 9648	-	4	-	-	-	2	-	-	-	2	-	-	
	RT _ 120	-	6	-	-	-	3	-	-	-	3	-	-	
	RT _ 144	-	6	-	-	-	3	-	-	-	3	-	-	
wedge 	W _ 7236	4	4	4	-	2	-	-	-	-	-	-	-	
	W _ 9648	-	4	-	-	-	-	-	-	-	2	-	-	
	W _ 120	-	6	-	-	-	-	-	-	-	3	-	-	
	W _ 144	-	6	-	-	-	-	-	-	-	3	-	-	
octagonal 	O _ 7236	4	4	4	-	2	2	-	-	-	-	-	-	
	O _ 9648	-	4	-	-	-	3	-	-	-	-	-	-	
	O _ 120	-	6	-	-	-	3	-	-	-	-	-	-	
	O _ 144	-	6	-	-	-	-	-	-	-	-	-	-	
boat shape 	B _ 7236	4	4	4	-	2	-	-	-	-	-	-	-	
	B _ 9648	-	4	-	-	-	2	-	-	-	-	2	-	
	B _ 120	-	6	-	-	-	3	-	-	-	-	3	-	
	B _ 144	-	6	-	-	-	3	-	-	-	-	3	-	
elliptical 	E _ 7236	4	4	4	-	-	-	-	-	-	-	-	-	
	E _ 9648	-	4	-	-	-	2	-	-	-	-	2	-	
	E _ 120	-	6	-	-	-	1 + (2)CC26	-	-	-	-	3	-	
	E _ 144	-	6	-	-	-	2 + (1)CC34 1 + (2)CC26	-	-	-	-	3	-	
peanut 	P _ 7240	4	4	4	-	2	-	2	-	-	-	-	-	
	P _ 9646	-	-	4	-	-	2	-	2	-	-	2	-	
	P _ 12048	-	-	6	-	-	3	-	3	-	-	3	-	
	P _ 14448	-	-	6	-	-	3	-	3	-	-	3	-	
hourglass 	H _ 7240	4	4	4	-	2	-	2	-	-	-	-	-	
	H _ 9640	-	-	4	-	-	2	-	2	-	-	2	-	
	H _ 12048	-	-	6	-	-	3	-	3	-	-	3	-	
	H _ 14448	-	-	6	-	-	3	-	3	-	-	3	-	

base model	base model	base model	base model	base model	base model	base model	base model	base model	base model	base model	base model
VB - __	TB-22 - __	1/2 R-24-__	DB-24 - __	PLB - __	PLBM-24 - __	PLBV-24 - __	SB-22 - __	SQB-20 - __	XB-24 - __	XB-36 - __	
	TB-29 - __	1/2 R-32-__	DB-32 - __		PLBM-36 - __	PLBV-36 - __	SB-29 - __	SQB-24 - __	XB-30 - __	QA - __	
base qty		base qty			base qty	base qty	base qty	base qty	base qty	base qty	base qty
				-				-			
				-				-			
				-				-			
2	2	-	-	4	2	-	2	-	2	-	-
2	2	-	-	4	2	-	2	-	2	-	-
2	2	-	-	4	2	-	2	-	2	-	-
2	-	2	2	4	2	-	2	-	2	-	2
2 + (1)SB-24	-	3	2 + (1)DB24	6	3	-	3	-	3	-	3
2 + (1)SB-24	-	3	2 + (1)DB24	6	3	-	3	-	3	-	3
-	-	-	3	8	4	-	4	-	4	-	3
-	-	-	2	4	-	2	-	2	-	2	2
-	-	-	-	6	-	3	-	3	-	2	2
-	-	-	2+(1) DB32	8	-	4	-	4	-	3	3
2	2	-	2	4	2	-	2	-	2	-	-
2	-	2	2	4	2	-	2	-	2	-	2
2 + (1)SB-24	-	3	2 + (1)DB24	6	3	-	3	-	3	-	3
2 + (1)SB-24	-	3	2 + (1)DB24	6	3	-	3	-	3	-	3
2	2	-	2	4	2	-	2	-	2	-	-
2	-	2	2	4	2	-	2	-	2	-	2
2 + (1)SB-24	-	3	2 + (1)DB24	6	3	-	3	-	3	-	3
2 + (1)SB-24	-	3	2 + (1)DB24	6	3	-	3	-	3	-	3
2	2	-	2	4	2	-	2	-	2	-	-
2	-	2	2	4	2	-	2	-	2	-	2
2 + (1)SB-24	-	3	2 + (1)DB24	6	3	-	3	-	3	-	3
2 + (1)SB-24	-	3	2 + (1)DB24	6	3	-	3	-	3	-	3
2	2	-	-	4	-	2	-	-	2	-	-
2	-	2	2	4	-	2	-	2	-	2	2
2 + (1)SB-24	-	3	3	6	-	3	-	3	-	2	3
2 + (1)SB-24	-	3	3	6	-	3	-	3	-	2	3
2	2	-	-	4	2	-	2	-	2	-	-
2	-	2	2	4	2	-	2	-	2	-	2
2 + (1)SB-24	2 + (1)TB29	3	2 + (1)DB24	6	2+1(36)	-	2+1(36)	-	3	-	3
2 + (1)SB-24	2 + (1)TB29	3	2 + (1)DB24	6	2+1(36)	-	2+1(36)	-	3	-	3
	2	-	-		2	-	2	-	2	-	-
	-	2	2		2	-	2	-	2	-	2
	-	3	2 + (1)DB24		3	-	-	-	3	-	3
	-	3	2 + (1)DB24		3	-	-	-	3	-	3
2	2	-	-	4	2	-	2	-	2	-	-
2	-	2	2	4	2	-	2	-	2	-	2
2 + (1)SB-24	-	3	3	6	3	-	3	-	3	-	3
2 + (1)SB-24	-	3	3	6	3	-	3	-	3	-	3

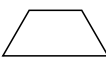
conference

base model	base model	base model	base model	base model	base model	base model	base model
AL - __	LB4 - __	CC-20 - __	CC-34 - __	CX-26 - __	CX-48 - __	PDB-20 - __	LT set - __
	LB2 - __	CC-26 - __		CX-38 - __		PDB-24 - __	
						PDB-32 - __	

top shape	model number	base qty			base qty			base qty			base qty		
crescent 	CT_42				-	-		1			-	-	
circular 	C_36	4	4	4	-	-	-	1	-	-	1	-	-
	C_42	4	4	4	-	-	-	-	1	-	-	1	-
	C_48	4	4	4	-	-	-	-	1	-	-	1	-
	C_60	4	4	4	-	-	-	-	-	1	-	-	1
clover 	CL_48		4	4	-	-		-	1	-	1	-	1
flower 	FL_60		4	-	-			-	-	1	-		
square 	S_36	4	4	4	-	-	-	1	-	-		-	1
	S_42	4	4	4	-	-	-	-	1	-	1	-	1
	S_48	4	4	4	-	-	-	-	1	-	-	-	1
	S_60	4	4	4	-	-	-	-	1	1		-	1
trapezoid 	TR_48	4	-	4	2	-	-	-	-	-	-	-	-
	TR_60	4	4	4	-	2	-	-	-	-	-	-	-
manta 	MT_48		-	3	-			-	-			-	
kidney 	KD_7248		4	4	-			-	-	-		-	1
half moon 		4		4	-	-	-	-	-	-		-	-
		4		4	2	-	-	1	-	-		-	-
		4		4	2	-	-	-	-	-		-	-
		4		4	2	-	-	-	1	-		-	-









## RO9648-6LC-F

top shape (type) - top dimension - top option (materials) - top finish - edge shape

## VB-6LC

base option - base finish

conference

	top shape	model number	d	w	cwt		cu ft
 <p>rectangular</p> <p>(BASES SOLD SEPARATELY) - TO ADD AN APRON, SPECIFY "A" AT END OF MODEL NUMBER AND ADD \$267.00 LIST UPCHARGE FOR EITHER ZONE</p> <p>Quick Ship available in 25M mahogany with wood edge [QS]</p>		<b>R-3624</b> -	36	24	40 lb	70	
		<b>R-4824</b> -	48	24	50 lb	70	
		<b>R-6024</b> -	60	24	65 lb	70	
		<b>R-7224</b> -	72	24	80 lb	70	
		<b>R-6036</b> -	60	36	95 lb	70	13
		<b>R-7236</b> -	72	36	105 lb	70	
		<b>R-9636</b> -	96	36	170 lb	70	21
		<b>R-9648</b> -	96	48	185 lb	70	21
		<b>R-120</b> - (TWO PIECE TOP)	120	48	235 lb	70	
		<b>R-144</b> - (TWO PIECE TOP)	144	48	255 lb	70	
		<b>R-168</b> - (TWO PIECE TOP)	168	48	300 lb	70	
		<b>R-9660</b> -	96	60	200 lb	70	
<b>R-12060</b> - (TWO PIECE TOP)	120	60	260 lb	70			
<b>R-16860</b> - (TWO PIECE TOP)	168	60	320 lb	70	168		
 <p>racetrack</p> <p>(BASES SOLD SEPARATELY)</p>		<b>RT-7236</b> -	72	36	105 lb	70	
		<b>RT-9648</b> -	96	48	185 lb	70	
		<b>RT-120</b> - (TWO PIECE TOP)	120	48	235 lb	70	
		<b>RT-144</b> - (TWO PIECE TOP)	144	48	255 lb	70	
 <p>wedge</p> <p>(BASES SOLD SEPARATELY) - TO ADD AN APRON, SPECIFY "A" AT END OF MODEL NUMBER AND ADD \$245.00 LIST UPCHARGE FOR EITHER ZONE</p>		<b>W-7236</b> -	72	36	105 lb	70	13
		<b>W-9648</b> -	96	48	185 lb	70	
		<b>W-120</b> - (TWO PIECE TOP)	120	48	235 lb	70	
		<b>W-144</b> - (TWO PIECE TOP)	144	48	255 lb	70	
 <p>octagonal</p> <p>(BASES SOLD SEPARATELY) - TO ADD AN APRON, SPECIFY "A" AT END OF MODEL NUMBER AND ADD \$245.00 LIST UPCHARGE FOR EITHER ZONE</p>		<b>O-7236</b> -	72	36	105 lb	70	
		<b>O-9648</b> -	96	48	185 lb	70	
		<b>O-120</b> - (TWO PIECE TOP)	120	48	235 lb	70	32
		<b>O-144</b> - (TWO PIECE TOP)	144	48	255 lb	70	
 <p>boat shape</p> <p>(BASES SOLD SEPARATELY) - TO ADD AN APRON, SPECIFY "A" AT END OF MODEL NUMBER AND ADD \$245.00 LIST UPCHARGE FOR EITHER ZONE</p>		<b>B-7236</b> -	72	36	105 lb	70	
		<b>B-9648</b> -	96	48	185 lb	70	
		<b>B-120</b> - (TWO PIECE TOP)	120	48	235 lb	70	
		<b>B-144</b> - (TWO PIECE TOP)	144	48	255 lb	70	32
 <p>elliptical</p> <p>(BASES SOLD SEPARATELY)</p>		<b>E-7236</b> -	72	36	105 lb	70	
		<b>E-9648</b> -	96	48	185 lb	70	
		<b>E-120</b> - (TWO PIECE TOP)	120	48	235 lb	70	
		<b>E-144</b> - (TWO PIECE TOP)	144	48	255 lb	70	

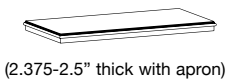

**wood**  
top &  
edge  
finishes

- 88M-W** mahogany on cherry
- MB-W** mocha on birch
- NB-W** natural on birch
- CB-W** cherry on birch
- 3L-W** saddle on walnut
- 2KL-W** sepia on walnut
- 4L-W** dark mahogany on walnut
- 25M-W** mahogany on walnut
- 25B-W** ebony on walnut
- 25C-W** cherry on walnut

**wood**  
top &  
edge  
finishes

- 2ML-W** natural maple on maple
- 3ML-W** light maple on maple
- 4ML-W** medium maple on maple
- 5ML-W** cherry on maple
- 1NC-W** natural cherry on cherry
- 2HC-W** honey cherry on cherry
- 6LC-W** light cherry on cherry
- 7MC-W** medium cherry on cherry
- 8DC-W** dark cherry on cherry
- 9BC-W** burgundy cherry on cherry

**pvc edge**  
color  
options

- BL** black
- FG** fog
- FS** folkstone
- HZ** haze
- LB** light beige
- PD** pepperdust
- SL** slate

**top**

- W** veneer top
- P** laminate top
- GB** ganging brackets (tables over 42" wide need 2) \$102 list ea.
- NS** nester



2.25" thick tops (self edge) \$265 list upcharge (standard thickness 1.25")



laminat top SELF EDGE (S)		laminat top PVC EDGE (P)		laminat top WOOD EDGE (W)		SELF EDGE (V)		veneer top WOOD EDGE (O)	
list \$ zone 1	list \$ zone 2	list \$ zone 1	list \$ zone 2	list \$ zone 1	list \$ zone 2	list \$ zone 1	list \$ zone 2	list \$ zone 1	list \$ zone 2
206	215	254	265	371	395			648	699
215	236	303	320	485	516			762	823
340	360	429	455	563	605			852	921
417	441	548	581	666	716			1,226	1,323
708	760	746	807	775	833				
861	935	879	947	965	1,039			1,652	1,784
1,165	1,251	1,204	1,301	1,225	1,318				
1,108	1,192	1,133	1,355	1,911	2,066			2,855	3,087
1,430	1,537	1,470	1,581	2,213	2,382			3,478	3,757
1,611	1,726	1,693	1,822	2,535	2,647			3,642	3,932
2,358	2,527	2,410	2,854	3,967	4,273			5,855	6,317
1,182	1,276	1,215	1,311	2,040	2,202			4,726	5,104
1,585	1,713	1,611	1,739	2,367	2,557			6,756	7,296
2,507	2,698	2,573	2,764	4,223	4,550			7,937	8,611
1,061	1,144	1,090	1,172	2,181	2,291			2,995	3,106
1,347	1,481	1,387	1,493	2,555	2,661			4,566	4,931
1,747	1,887	1,800	1,936	3,814	4,117			7,309	7,530
2,057	2,223	2,143	2,305	3,956	4,270			7,442	7,662
1,577	1,697			1,667	1,797			3,079	3,330
2,199	2,367			2,291	2,467			3,919	4,233
2,661	2,736			2,687	3,351			7,257	7,479
2,805	3,018			2,893	3,564			7,391	7,611
1,667	1,797			1,771	1,911	2,368	2,552	3,562	3,846
2,291	2,467			3,096	3,343	3,185	3,428	4,356	4,704
2,577	2,770			3,361	3,628	6,039	6,535	7,247	7,826
2,893	3,117			3,823	4,128	6,175	6,703	7,468	8,066
1,577	1,697			2,509	2,624			2,993	3,171
2,199	2,367			3,130	3,296			3,831	4,062
2,726	2,946			4,122	4,343			7,167	7,389
2,805	3,018			4,202	4,417			7,300	7,521
1,061	1,144	1,091	1,172			2,099	2,262		
1,347	1,452	1,387	1,493			2,915	3,138		
1,747	1,887	1,800	1,936			5,771	6,215		
2,057	2,223	2,143	2,305			5,905	6,361		

conference

<p>• maple finish option available on the following:</p> <p><b>rectangular</b> - RS, RP, RW, RO</p> <p><b>racetrack</b> - RTS, RTP, RTO</p> <p><b>octagonal</b> - OS, OV</p> <p><b>boat shape</b> - BS, BV, BO, BW</p> <p><b>creseent</b> - CTS, CTP, CTW, CTO</p> <p><b>circular</b> - CS, CP, CW, CO</p>	<p><b>laminat</b></p> <p>mocha on birch laminatenatural on birch laminat</p> <p>cherry on birch laminat</p> <p>saddle on walnut</p> <p>dark mahogany on walnut</p> <p>mahogany on walnut</p> <p>cherry on walnutlight</p> <p>cherry on cherry</p> <p>medium cherry on cherry</p> <p>dark cherry on cherrynatural maple on maple</p> <p>light maple on maple</p> <p>medium maple on maple</p> <p>cherry on maple on maple</p>	<p><b>laminat</b></p> <p>solid &amp; mixed colors</p> <p>top &amp; edge finishes</p>	<p><b>BA</b> black ashwood</p> <p><b>BB</b> bethany beige</p> <p><b>BL</b> black</p> <p><b>CF</b> copper fusion</p> <p><b>CL</b> chili</p> <p><b>CM</b> cardamom fiber</p> <p><b>CN</b> cinnamon</p> <p><b>CO</b> coriander fiber</p> <p><b>CU</b> curacao fiber</p> <p><b>EW</b> eggshell white</p> <p><b>GS</b> graphite specktrum</p> <p><b>GV</b> galvan</p> <p><b>NV</b> negotiating in geneva</p> <p><b>OS</b> olive serenity</p> <p><b>RA</b> rock of ages</p> <p><b>SU</b> sugar fiber</p> <p><b>TY</b> thyme fiber</p> <p><b>WH</b> wheat fiber</p>	<p><b>laminat</b></p> <p>top &amp; edge finishes</p>	<p><b>Designer palette</b> (5%upcharge plus \$80 net freight charge)</p> <p><b>SPL</b> special laminat, provide manufacturer and item # _____</p> <p>birch veneer not available on tops for birch finishes, use maple veneer</p> <p>6 week leadtime to run a one piece top with grain running long direction list upcharges: 96"/\$1,044, 120"/\$1,116, 144"/\$1,565</p>
--	--	--	--	--	--







## RO9648-6LC-F

top shape (type) - top dimension - top option (materials) - top finish - edge shape

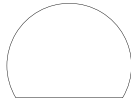
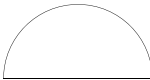
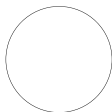
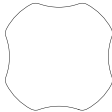
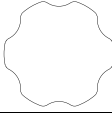
## VB-6LC

base option - base finish

	top shape	model number	d	w	cwt		cu ft
	crescent <i>(BASES SOLD SEPARATELY)</i>	<b>CT-42</b> - _	42 dia.		50 lb	70	
	half moon <i>(BASES SOLD SEPARATELY)</i>	<b>HM-36</b> - _ <b>HM-42</b> - _ <b>HM-48</b> - _ <b>HM-60</b> - _	18 21 24 30	36 42 48 60	25 lb 30 lb 35 lb 40 lb	70 70 70 70	
	circular <i>(BASES SOLD SEPARATELY)</i> <small>Quick ship available in 25M Mahogany or 25C cherry with wood F edge and laminate tops only.</small>	<b>C-36</b> - _ <b>C-42</b> - _ <b>C-48</b> - _ <b>C-60</b> - _	36 dia. 42 dia. 48 dia. 60 dia.		40 lb 50 lb 60 lb 75 lb	70 70 70 70	3 5
	clover <i>(BASES SOLD SEPARATELY)</i>	<b>CL-48</b> - _	48 dia.		55 lb	70	
	flower <i>(BASES SOLD SEPARATELY)</i>	<b>FL-60</b> - _	60 dia.		65 lb	70	
	square <i>(BASES SOLD SEPARATELY)</i>	<b>S-36</b> - _ <b>S-42</b> - _ <b>S-48</b> - _ <b>S-60</b> - _	36 42 48 60	36 42 48 60	40 lb 50 lb 55 lb 75 lb	70 70 70 70	
	trapezoid <i>(BASES SOLD SEPARATELY)</i>	<b>TR-48</b> - _ <b>TR-60</b> - _	48 60	24 30	55 lb 65 lb	70 70	
	manta <i>(BASES SOLD SEPARATELY)</i>	<b>MT-48</b> - _	48	24	55 lb	70	
	kidney <i>(BASES SOLD SEPARATELY)</i>	<b>KD-7248</b> - _	72	48	130 lb	70	

conference

**wood**  
top &  
edge  
finishes

- 88M-W** mahogany on cherry
- MB-W** mocha on birch
- NB-W** natural on birch
- CB-W** cherry on birch
- 3L-W** saddle on walnut
- 2KL-W** sepia on walnut
- 4L-W** dark mahogany on walnut
- 25M-W** mahogany on walnut
- 25B-W** ebony on walnut
- 25C-W** cherry on walnut

**wood**  
top &  
edge  
finishes

- 2ML-W** natural maple on maple
- 3ML-W** light maple on maple
- 4ML-W** medium maple on maple
- 5ML-W** cherry on maple
- 1NC-W** natural cherry on cherry
- 2HC-W** honey cherry on cherry
- 6LC-W** light cherry on cherry
- 7MC-W** medium cherry on cherry
- 8DC-W** dark cherry on cherry
- 9BC-W** burgundy cherry on cherry

**pvc edge**  
color  
options

- BL** black
- FG** fog
- FS** folkstone
- HZ** haze
- LB** light beige
- PD** pepperdust
- SL** slate

**top**

- W** veneer top
- P** laminate top
- GB** ganging brackets (tables over 42" wide need 2) \$102 list ea.
- NS** nester



2.25" thick tops (self edge) \$265 list upcharge (standard thickness 1.25")



laminated top SELF EDGE (S)		laminated top PVC EDGE (P)		laminated top WOOD EDGE (W)		SELF EDGE (V)		veneer top WOOD EDGE (O)	
list \$ zone 1	list \$ zone 2	list \$ zone 1	list \$ zone 2	list \$ zone 1	list \$ zone 2	list \$ zone 1	list \$ zone 2	list \$ zone 1	list \$ zone 2
992	1,070	1,010	1,086	1,280	1,378			2,022	2,183
334	359	343	371	458	498			958	1,031
345	372	355	384	500	508			1,006	1,088
372	398	387	415	545	588			1,136	1,228
467	503	542	588	660	714			1,689	1,825
476	513	493	529	762	822			1,626	1,756
508	550	527	568	914	986			1,730	1,867
692	740	697	755	1,092	1,182			1,988	2,146
844	909	852	921	1,319	1,423			3,378	3,650
532	577	602	621			1,742	1,857		
784	848	830	897						
313	342	324	350	336	365			1,243	1,309
355	384	369	397	377	408			1,576	1,653
468	503	483	522	499	538			1,835	1,913
576	621	654	705	685	741			2,773	2,996
498	529	509	546						
509	546	525	567						
478	511	492	529						
1,376	1,480	1,423	1,534						

conference

• maple finish option available on the following:  
**rectangular** - RS, RP, RW, RO  
**racetrack** - RTS, RTP, RTO  
**octagonal** - OS, OV  
**boat shape** - BS, BV, BO, BW  
**crecscant** - CTS, CTP, CTW, CTO  
**circular** - CS, CP, CW, CO

**laminated** mocha on birch laminated natural on birch laminated cherry on birch laminated saddle on walnut dark mahogany on walnut mahogany on walnut cherry on cherry medium cherry on cherry dark cherry on cherry natural maple on maple light maple on maple medium maple on maple cherry on maple on maple

**laminated** solid & mixed colors  
top & edge finishes  
**BA**  
**BB**  
**BL**  
**CF**  
**CL**  
**CM**  
**CN**  
**CO**  
**CU**  
**EW**  
**GS**  
**GV**  
**NV**  
**OS**  
**RA**  
**SU**  
**TY**  
**WH**

black ashwood  
bethany beige  
black  
copper fusion  
chili  
cardamom fiber  
cinnamon  
coriander fiber  
curacao fiber  
eggshell white  
graphite spectrum  
galvan  
negotiating in geneva  
olive serenity  
rock of ages  
sugar fiber  
thyme fiber  
wheat fiber



**laminated** top & edge finishes  
**Designer palette** (5% upcharge plus \$80 net freight charge)  
**SPL** special laminated, provide manufacturer and item # \_\_\_\_\_  
birch veneer not available on tops for birch finishes, use maple veneer  
6 week leadtime to run a one piece top with grain running long direction list upcharges: 96"/\$1,044, 120"/\$1,167, 144"/\$1,565

## RO9648-6LC-F

top shape (type) - top dimension - top option (materials) - top finish - edge shape

## VB-6LC

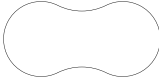
base option - base finish

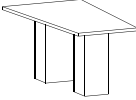
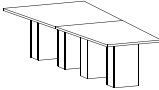
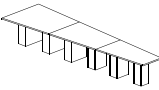
	top shape	model number	d	w	cwt	cu ft
	peanut <i>(BASES SOLD SEPARATELY)</i>	<b>P-7240</b> - __	72	40	100 lb	70
		<b>P-9646</b> - __	96	46	180 lb	70
		<b>P-120</b> - __ <i>(TWO PIECE TOP)</i>	120	48	230 lb	70
		<b>P-144</b> - __ <i>(TWO PIECE TOP)</i>	144	48	250 lb	70
	hourglass <i>(BASES SOLD SEPARATELY)</i>	<b>H-7246</b> - __	72	46	100 lb	70
		<b>H-9646</b> - __	96	46	180 lb	70
		<b>H-120</b> - __ <i>(TWO PIECE TOP)</i>	120	48	230 lb	70
		<b>H-144</b> - __ <i>(TWO PIECE TOP)</i>	144	48	250 lb	70
	teleconferencing table with two bases included	<b>TCT - 723040</b> (one piece top)	72	30 & 40	cwt 100 lb	70
		<b>TCT - 1443050</b> (two piece top)	144	30 & 50	cwt 240 lb	70
		<b>TCT - 2163060</b> (three piece top)	216	30 & 60	cwt 420 lb	70
	teleconferencing table (two piece top) with four bases included	<b>TCT - 1443050</b>				
	teleconferencing table (three piece top) with six bases included	<b>TCT - 2163060</b>				

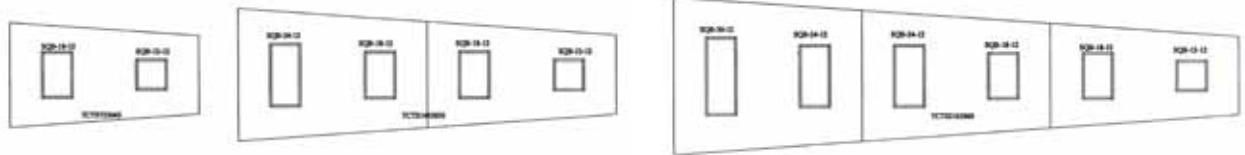

conference

**wood**  
top &  
edge  
finishes

- 88M-W** mahogany on cherry
- MB-W** mocha on birch
- NB-W** natural on birch
- CB-W** cherry on birch
- 3L-W** saddle on walnut
- 2KL-W** sepia on walnut
- 4L-W** dark mahogany on walnut
- 25M-W** mahogany on walnut
- 25B-W** ebony on walnut
- 25C-W** cherry on walnut

**wood**  
top &  
edge  
finishes

- 2ML-W** natural maple on maple
- 3ML-W** light maple on maple
- 4ML-W** medium maple on maple
- 5ML-W** cherry on maple
- 1NC-W** natural cherry on cherry
- 2HC-W** honey cherry on cherry
- 6LC-W** light cherry on cherry
- 7MC-W** medium cherry on cherry
- 8DC-W** dark cherry on cherry
- 9BC-W** burgundy cherry on cherry

**pvc edge**  
color  
options

- BL** black
- FG** fog
- FS** folkstone
- HZ** haze
- LB** light beige
- PD** pepperdust
- SL** slate

**top**

- W** veneer top
- P** laminate top
- GB** ganging brackets (tables over 42" wide need 2) \$102 list ea.
- NS** nester



2.25" thick tops (self edge) \$265 list upcharge (standard thickness 1.25")



laminated top SELF EDGE (S)		laminated top PVC EDGE (P)		laminated top WOOD EDGE (W)		SELF EDGE (V)		veneer top WOOD EDGE (O)			
list \$	zone 1	list \$	zone 2	list \$	zone 1	list \$	zone 2	list \$	zone 1	list \$	zone 2
1,400		1,512		1,439		1,556					
1,400		1,512		1,439		1,556					
1,789		1,933		1,839		1,988					
2,092		2,258		2,198		2,348					
1,400		1,512		1,439		1,556					
1,400		1,512		1,439		1,556					
1,789		1,933		1,839		1,988					
2,092		2,258		2,198		2,348					
2,888		3,119				2,972		3,210		4,466	6,453
5,974		4,825				6,059		6,589		9,063	9,787
8,558		9,861				9,239		9,977		13,660	14,752

conference

• **maple finish option**  
available on the following:  
**rectangular** - RS, RP, RW, RO  
**racetrack** - RTS, RTP, RTO  
**octagonal** - OS, OV  
**boat shape** - BS, BV, BO, BW  
**crenate** - CTS, CTP, CTW, CTO  
**circular** - CS, CP, CW, CO



**laminated** mocha on birch laminated natural on birch laminated  
cherry on birch laminated  
saddle on walnut  
dark mahogany on walnut  
mahogany on walnut  
cherry on walnut  
dark cherry on cherry  
medium cherry on cherry  
dark cherry on cherry  
natural maple on maple  
light maple on maple  
medium maple on maple  
cherry on maple on maple



**laminated** solid & mixed colors  
**top & edge finishes**  
**BA** black ashwood  
**BB** bethany beige  
**BL** black  
**CF** copper fusion  
**CL** chili  
**CM** cardamom fiber  
**CN** cinnamon  
**CO** coriander fiber  
**CU** curacao fiber  
**EW** eggshell white  
**GS** graphite spectrum  
**GV** galvan  
**NV** negotiating in geneva  
**OS** olive serenity  
**RA** rock of ages  
**SU** sugar fiber  
**TY** thyme fiber  
**WH** wheat fiber

**laminated** top & edge finishes  
**Designer palette** (5% upcharge plus \$80 net freight charge)  
**SPL** special laminate, provide manufacturer and item # \_\_\_\_\_  
birch veneer not available on tops for birch finishes, use maple veneer  
6 week leadtime to run a one piece top with grain running long direction  
list upcharges: 96"/\$1,044, 120"/\$1,167, 144"/\$1,565

## CX26-BL-C

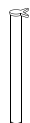
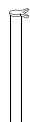
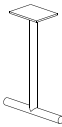
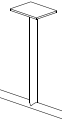
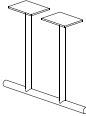
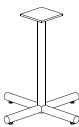
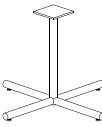
unit identification (type), - base finish - casters

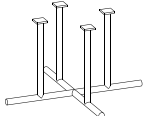
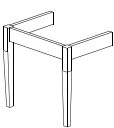
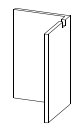
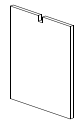
	model number		d w h	freight	list \$ zone 1	zone 2
	<b>AL</b>  <b>AL-A</b>	single post leg 2.5 inch diameter 11 gauge steel tubing caster at no additional charge standard matte black finish  <small>ALUMINUM FINISH SPECIFY "A" \$20 LIST UPCHARGE PER LEG OR \$75 FOR SET OF 4</small>	2.5 dia	class 70 cwt 4 lb cu ft 4	<b>203</b>	<b>216</b>
	<b>LB4</b>  <b>LB4-A</b>	single post leg 4 inch diameter 16 gauge steel tubing standard matte black finish  <small>ALUMINUM FINISH SPECIFY "A" \$20 LIST UPCHARGE PER LEG OR \$75 FOR SET OF 4</small>	4 dia	class 70 cwt 10 lb cu ft	<b>158</b>	<b>170</b>
	<b>LB2</b>  <b>LB2-A</b>	single post leg 2 inch diameter 16 gauge steel tubing standard matte black finish  <small>ALUMINUM FINISH SPECIFY "A" \$20 LIST UPCHARGE PER LEG OR \$75 FOR SET OF 4</small>	2 dia	class 70 cwt 16 lb cu ft	<b>89</b>	<b>98</b>
	<b>LB2-C</b>  <b>LB2-C-A</b>	single post leg with caster 2 inch diameter 16 gauge steel tubing standard matte black finish  <small>ALUMINUM FINISH SPECIFY "A" \$20 LIST UPCHARGE PER LEG OR \$75 FOR SET OF 4</small>	2 dia	class 70 cwt 16 lb cu ft	<b>118</b>	<b>128</b>
	<b>CC-20</b> <b>CC-20-C</b> <b>CC-20-WM</b>	T-style base, 2 inch diameter 13 gauge tubular steel single upright column standard matte black finish  <small>CHROME UPCHARGE 15% SPECIFY "C" FOR LEGS WITH CASTERS SPECIFY "WM" FOR WIRE MANAGEMENT</small>	2 dia	class 70 cwt 25 lb cu ft	<b>321</b> <b>380</b> <b>531</b>	<b>344</b> <b>403</b> <b>575</b>
	<b>CC-26</b> <b>CC-26-C</b> <b>CC-26-WM</b>	T-style base, 2 inch diameter 13 gauge tubular steel single upright column standard matte black finish  <small>SPECIFY "C" FOR LEGS WITH CASTERS SPECIFY "WM" FOR WIRE MANAGEMENT</small>	2 dia	class 70 cwt 35 lb cu ft 1	<b>329</b> <b>389</b> <b>534</b>	<b>359</b> <b>417</b> <b>577</b>
	<b>CC-34</b> <b>CC-34-C</b> <b>CC-34-WM</b>	T-style base, 2 inch diameter 13 gauge tubular steel two upright columns standard matte black finish	2 dia	class 70 cwt 40 lb cu ft	<b>503</b> <b>562</b> <b>920</b>	<b>543</b> <b>607</b> <b>992</b>
	<b>CX-26</b> <b>CX-26-C</b> <b>CX-26-WM</b>	X-style base, 2 inch diameter 13 gauge tubular steel single upright column standard matte black finish	2 dia	class 70 cwt 30 lb cu ft	<b>512</b> <b>630</b> <b>711</b>	<b>553</b> <b>681</b> <b>768</b>
	<b>CX-38</b> <b>CX-38-C</b> <b>CX-38-WM</b>	X-style base, 2 inch diameter 13 gauge tubular steel single upright column standard matte black finish	2 dia	class 70 cwt 45 lb cu ft	<b>611</b> <b>728</b> <b>806</b>	<b>659</b> <b>786</b> <b>871</b>

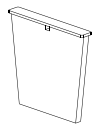
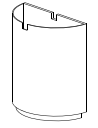
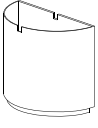
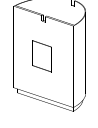
	model number	description	d	w	h	freight	zone 1	zone 2
	<b>CX-48</b>	X-style base, 2 inch diameter 13 gauge tubular steel	2	dia		class 70	<b>975</b>	<b>1,053</b>
	<b>CX-48-C</b>	four column uprights standard matte black finish				cwt 30 lb	<b>1,092</b>	<b>1,180</b>
	<b>CX-48-WM</b>	<i>SPECIFY "C" FOR LEGS WITH CASTERS SPECIFY "WM" FOR WIRE MANAGEMENT</i>				cu ft	<b>1,207</b>	<b>1,303</b>
	<b>LT</b>	hardwood frame with apron 463 custom made for each table  <i>SET OF FOUR LEGS (TWO SHOWN)</i>				class 70 cwt 16 lb cu ft	<b>468</b>	<b>505</b>
	<b>VB - _</b>	v-shaped wood base  <i>NOTCHED FOR WIRE MANAGEMENT</i>	13.125	30		class 70 cwt 75 lb cu ft	<b>388</b>	<b>419</b>
	<b>SB-24 - _</b>	use SB-24 when using two VB bases  <i>NOTCHED FOR WIRE MANAGEMENT</i>	1.33	24	27.75	class 70 cwt 75 lb cu ft	<b>322</b>	<b>373</b>
	<b>TB-22 - _</b>	tapered wood base  <i>NOTCHED FOR WIRE MANAGEMENT</i>		22		class 70 cwt 40 lb cu ft	<b>417</b>	<b>452</b>
	<b>TB-29 - _</b>	tapered wood base  <i>NOTCHED FOR WIRE MANAGEMENT</i>		29		class 70 cwt 50 lb cu ft	<b>492</b>	524
	<b>1/2 R-24 - _</b>	half round drum wood base  <i>NOTCHED FOR WIRE MANAGEMENT</i>		24		class 70 cwt 40 lb cu ft	<b>761</b>	<b>822</b>
	<b>1/2 R-32 - _</b>	half round drum wood base  <i>NOTCHED FOR WIRE MANAGEMENT</i>		32		class 70 cwt 75 lb cu ft	<b>1,184</b>	<b>1,245</b>
	<b>1/2 R-24-AD - _</b>	half round drum wood base with hinged access door  notched for wire management		24		class 70 cwt 40 lb cu ft	<b>987</b>	<b>1,050</b>

bases only

- 2KL-W** sepia on walnut
- 3L-W** saddle on walnut
- 4L-W** dark mahogany on walnut
- 25M-W** mahogany on walnut
- 25B-W** ebony on walnut
- 25C-W** cherry on walnut
- 6LC-W** light cherry on cherry
- 7MC-W** medium cherry on cherry
- 8DC-W** dark cherry on cherry
- 9BC-W** burgundy cherry on cherry

**veneer**  
select maple  
bases only

- 2ML** natural maple on maple
- 3ML** light maple on maple
- 4ML** medium maple on maple
- 5ML** cherry on maple on maple

•maple finish options available only  
on select top shapes:

- crescent CTS, CTP, CTW, CTO
- circular CS, CP, CW, CO
- rectangular RS, RP, RW, RO
- racetrack RTS, RTP, RTV
- boat BS, BV
- octagonal OS, OV

conference

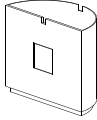
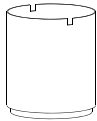
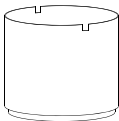
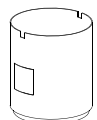
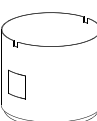
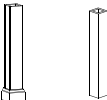
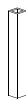
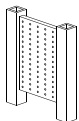
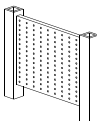
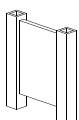
	model number		d	w	h	freight	list \$	zone 1	zone 2
	<b>1/2 R-32-AD -</b> __	half round drum wood base with hinged access door <i>NOTCHED FOR WIRE MANAGEMENT</i>		32		class 70 cwt 75 lb cu ft	<b>1,405</b>		<b>1,466</b>
	<b>DB-24 -</b> __	drum wood base <i>NOTCHED FOR WIRE MANAGEMENT</i>		24		class 70 cwt 55 lb cu ft 12	1,232		<b>1,276</b>
	<b>DB-32 -</b> __	drum wood base <i>NOTCHED FOR WIRE MANAGEMENT</i>		32		class 70 cwt 75 lb cu ft	<b>1,433</b>		<b>1,526</b>
	<b>DB-24-AD -</b> __	drum wood base with hinged access door <i>NOTCHED FOR WIRE MANAGEMENT</i>		24		class 70 cwt 55 lb cu ft	<b>1,460</b>		<b>1,503</b>
	<b>DB-32-AD -</b> __	drum wood base with hinged access door <i>NOTCHED FOR WIRE MANAGEMENT</i>		32		class 70 cwt 75 lb cu ft	<b>1,659</b>		<b>1,750</b>
	<b>PLB -</b> __	post leg base - wood (any species)	4 sq.			class 70	<b>265</b>		<b>287</b>
	<b>PLB-18 -</b> __	post leg base - wood w/1800 base trim (walnut only)	4 sq.			cwt 11 lb cu ft	<b>338</b>		<b>364</b>
	<b>PLBM-24 -</b> __	wood post leg base with perforated metal insert		24		class 70 cwt 25 lb cu ft 35	822		<b>887</b>
	<b>PLBM-36 -</b> __	wood post leg base with perforated metal insert		36		class 70 cwt 25 lb cu ft 35	<b>844</b>		<b>911</b>
	<b>PLBV-24 -</b> __	wood post leg base with veneer insert		24		class 70 cwt 35 lb cu ft 45	<b>822</b>		<b>887</b>

\* **CX bases** available with a flip top mechanism. add \$234 list upcharge

\* **wire management (WM)** not available in chrome or brushed steel

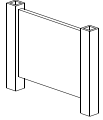
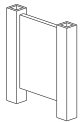
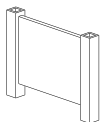
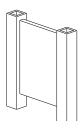
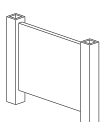
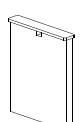
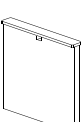
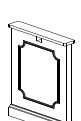
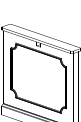
	model number	description	d	w	h	freight	zone 1	zone 2
	PLBV-36 - _	wood post leg base with veneer insert		36		class 70 cwt 35 lb cu ft 45	844	911
	PLBC-24 - _	wood post leg base with chemcast insert	24			class 70 cwt 25 lb cu ft 35	836	903
	PLBC-36 - _	wood post leg base with chemcast insert	36			class 70 cwt 25 lb cu ft 35	1,070	1,157
	PLBL-24 - _	wood post leg base with laminate insert	24			class 70 cwt 25 lb cu ft 35	532	575
	PLBL-36 - _	wood post leg base with laminate insert	36			class 70 cwt 25 lb cu ft 35	728	787
	SB-22 - _	slab wood base <i>NOTCHED FOR WIRE MANAGEMENT</i>	4	22	27.75	class 70 cwt 40 lb cu ft 3	322	373
	SB-29 - _	slab wood base <i>NOTCHED FOR WIRE MANAGEMENT</i>	4	29	27.75	class 70 cwt 50 lb cu ft 3	397	427
	SB19-22 - _	slab wood base traditional base style monticello series detailing with picture frame molding WALNUT VENEER ONLY <i>NOTCHED FOR WIRE MANAGEMENT</i>	4	22	27.75	class 70 cwt cu ft 2	492	571
	SB19-29 - _	slab wood base traditional base style monticello series detailing with picture frame molding WALNUT VENEER ONLY <i>NOTCHED FOR WIRE MANAGEMENT</i>	4	29	27.75	class 70 cwt cu ft 3	557	602

**veneer**  
bases only

- 2KL-W sepia on walnut
- 3L-W saddle on walnut
- 4L-W dark mahogany on walnut
- 25M-W mahogany on walnut
- 25B-W ebony on walnut
- 25C-W cherry on walnut
- 6LC-W light cherry on cherry
- 7MC-W medium cherry on cherry
- 8DC-W dark cherry on cherry
- 9BC-W burgundy cherry on cherry

**veneer**  
select maple  
bases only

- 2ML natural maple on maple
- 3ML light maple on maple
- 4ML medium maple on maple
- 5ML cherry on maple on maple

maple finish options available only on select top shapes:

- crescent CTS, CTP, CTW, CTO
- circular CS, CP, CW, CO
- rectangular RS, RP, RW, RO
- racetrack RTS, RTP, RTV
- boat BS, BV
- octagonal OS, OV



## CX26-BL-C

unit identification (type), - base finish - casters

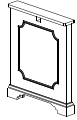
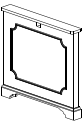
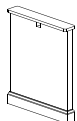
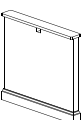
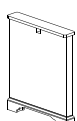
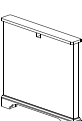
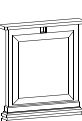
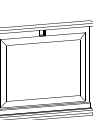
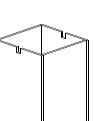
	model number		d	w	h	freight	list \$ zone 1	zone 2
	SB19BB-22 - __	wood bracket base traditional base style monticello series detailing with picture frame molding WALNUT VENEER ONLY  <i>NOTCHED FOR WIRE MANAGEMENT</i>	4	22	27.75	class 70 cwt cu ft 2	525	567
	SB19BB-29 - __	wood bracket base traditional base style monticello series detailing with picture frame molding WALNUT VENEER ONLY  <i>NOTCHED FOR WIRE MANAGEMENT</i>	4	29	27.75	class 70 cwt cu ft 3	619	667
	SB18-22 - __	slab wood traditional style base empire series detailing WALNUT VENEER ONLY  <i>NOTCHED FOR WIRE MANAGEMENT</i>	4	22	27.75	class 70 cwt cu ft 2	386	416
[ QS ] 	SB18-29 - __ Quick Ship available in 25M mahogany	slab wood traditional style base empire series detailing WALNUT VENEER ONLY  <i>NOTCHED FOR WIRE MANAGEMENT</i>	4	29	27.75	class 70 cwt cu ft 3	494	532
	SB18BB-22 - __	wood bracket base traditional base style empire series detailing WALNUT VENEER ONLY  <i>NOTCHED FOR WIRE MANAGEMENT</i>	4	22	27.75	class 70 cwt cu ft 2	457	482
	SB18BB-29 - __	wood bracket base traditional base style empire series detailing WALNUT VENEER ONLY  <i>NOTCHED FOR WIRE MANAGEMENT</i>	4	29	27.75	class 70 cwt cu ft 3	549	593
	SB13-22 - __	slab wood base traditional base style oxford series detailing CHERRY VENEER ONLY  <i>NOTCHED FOR WIRE MANAGEMENT</i>	4	22	27.75	class 70 cwt cu ft 2	939	1,018
	SB13-29 - __	slab wood base traditional base style oxford series detailing CHERRY VENEER ONLY  <i>NOTCHED FOR WIRE MANAGEMENT</i>	4	29	27.75	class 70 cwt cu ft 3	1,039	1,121
	SQB-20 - __	square wood base  <i>NOTCHED FOR WIRE MANAGEMENT</i>	20	20	27.75	class 70 cwt 55 lb cu ft 12	474	512

\* **cx bases** available with a flip top mechanism. add \$234 list upcharge

\* **wire management (WM)** not available in chrome or brushed steel

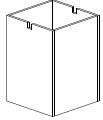
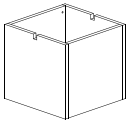
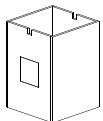
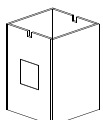
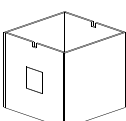
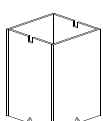
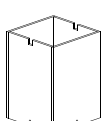
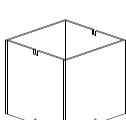
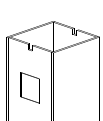
	model number	description	d	w	h	freight	zone 1	zone 2
	SQB-24 - _	square wood base <i>NOTCHED FOR WIRE MANAGEMENT</i>	20	24	27.75	class 70 cwt 65 lb cu ft 12	474	512
	SQB-30 - _	square wood base <i>NOTCHED FOR WIRE MANAGEMENT</i>	30	30	27.75	class 70 cwt 75 lb cu ft 19	474	512
	SQB-20-AD - _	square wood base with hinged access door <i>NOTCHED FOR WIRE MANAGEMENT</i>	20	20	27.75	class 70 cwt 2 cu ft 2	615	655
	SQB-24-AD - _	square wood base with hinged access door <i>NOTCHED FOR WIRE MANAGEMENT</i>	20	24	27.75	class 70 cwt 2 cu ft 2	615	655
	SQB-30-AD - _	square wood base with hinged access door <i>NOTCHED FOR WIRE MANAGEMENT</i>	30	30	27.75	class 70 cwt 3 cu ft 3	615	655
	SQB26-20 - _	square wood base contemporary base style progeny series detailing CHERRY VENEER ONLY <i>NOTCHED FOR WIRE MANAGEMENT</i>	20	20	27.75	class 70 cwt 2 cu ft 2	614	665
	SQB26-24 - _	square wood base contemporary base style progeny series detailing CHERRY VENEER ONLY <i>NOTCHED FOR WIRE MANAGEMENT</i>	20	24	27.75	class 70 cwt 2 cu ft 2	614	665
	SQB26-30 - _	square wood base contemporary base style progeny series detailing CHERRY VENEER ONLY <i>NOTCHED FOR WIRE MANAGEMENT</i>	30	30	27.75	class 70 cwt 3 cu ft 3	614	665
	SQB26-20-AD - _	square wood base with access door contemporary base style progeny series detailing CHERRY VENEER ONLY <i>NOTCHED FOR WIRE MANAGEMENT</i>	20	20	27.75	class 70 cwt 2 cu ft 2	757	807

**veneer**  
bases only

- 2KL-W** sepia on walnut
- 3L-W** saddle on walnut
- 4L-W** dark mahogany on walnut
- 25M-W** mahogany on walnut
- 25B-W** ebony on walnut
- 25C-W** cherry on walnut
- 6LC-W** light cherry on cherry
- 7MC-W** medium cherry on cherry
- 8DC-W** dark cherry on cherry
- 9BC-W** burgundy cherry on cherry

**veneer**  
select maple  
bases only

- 2ML** natural maple on maple
- 3ML** light maple on maple
- 4ML** medium maple on maple
- 5ML** cherry on maple on maple

maple finish options available only on select top shapes:

- crescent CTS, CTP, CTW, CTO
- circular CS, CP, CW, CO
- rectangular RS, RP, RW, RO
- racetrack RTS, RTP, RTV
- boat BS, BV
- octagonal OS, OV

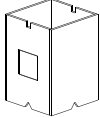
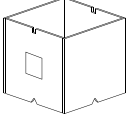
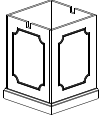
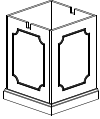
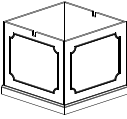
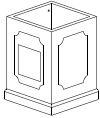
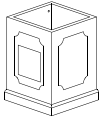
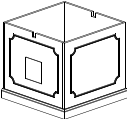
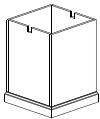
	model number		d	w	h	freight	list \$	zone 1	zone 2
	<b>SQB26-24-AD</b> - _	square wood base with access door contemporary base style progeny series detailing CHERRY VENEER ONLY  <i>NOTCHED FOR WIRE MANAGEMENT</i>	20	24	27.75	class 70 cwt cu ft 2	<b>757</b>		<b>807</b>
	<b>SQB26-30-AD</b> - _	square wood base with access door contemporary base style progeny series detailing CHERRY VENEER ONLY  <i>NOTCHED FOR WIRE MANAGEMENT</i>	30	30	27.75	class 70 cwt cu ft 3	<b>757</b>		<b>807</b>
	<b>SQB19-20</b> - _	square wood base traditional base style monticello series detailing WALNUT VENEER ONLY  <i>NOTCHED FOR WIRE MANAGEMENT</i>	20	20	27.75	class 70 cwt 55 lb cu ft 12	<b>745</b>		<b>804</b>
	<b>SQB19-24</b> - _	square wood base traditional base style monticello series detailing WALNUT VENEER ONLY  <i>NOTCHED FOR WIRE MANAGEMENT</i>	20	24	27.75	class 70 cwt cu ft 2	<b>745</b>		<b>804</b>
	<b>SQB19-30</b> - _	square wood base traditional base style monticello series detailing WALNUT VENEER ONLY  <i>NOTCHED FOR WIRE MANAGEMENT</i>	30	30	27.75	class 70 cwt cu ft 3	<b>745</b>		<b>804</b>
	<b>SQB19-20-AD</b> - _	square wood base with access door traditional base style monticello series detailing WALNUT VENEER ONLY  <i>NOTCHED FOR WIRE MANAGEMENT</i>	20	20	27.75	class 70 cwt cu ft 2	<b>887</b>		<b>946</b>
	<b>SQB19-24-AD</b> - _	square wood base with access door traditional base style monticello series detailing WALNUT VENEER ONLY  <i>NOTCHED FOR WIRE MANAGEMENT</i>	20	24	27.75	class 70 cwt cu ft 2	<b>887</b>		<b>946</b>
	<b>SQB19-30-AD</b> - _	square wood base with access door traditional base style monticello series detailing WALNUT VENEER ONLY  <i>NOTCHED FOR WIRE MANAGEMENT</i>	30	30	27.75	class 70 cwt cu ft 3	<b>887</b>		<b>946</b>
	<b>SQB18-20</b> - _	square wood base traditional base style empire series detailing WALNUT VENEER ONLY  <i>NOTCHED FOR WIRE MANAGEMENT</i>	20	20	27.75	class 70 cwt cu ft 2	<b>619</b>		<b>667</b>

square bases can be made any depth down to 8" at standard price

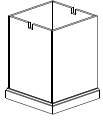
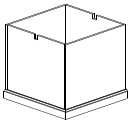
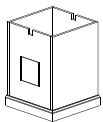
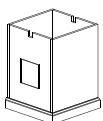
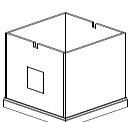
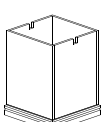
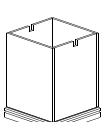
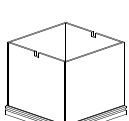
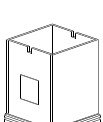
	model number	description	d	w	h	freight	zone 1	zone 2
	<b>SQB18-24</b> - _	square wood base traditional base style empire series detailing WALNUT VENEER ONLY  <i>NOTCHED FOR WIRE MANAGEMENT</i>	20	24	27.75	class 70 cwt cu ft 2	<b>619</b>	<b>667</b>
	<b>SQB18-30</b> - _	square wood base traditional base style empire series detailing WALNUT VENEER ONLY  <i>NOTCHED FOR WIRE MANAGEMENT</i>	30	30	27.75	class 70 cwt cu ft 3	<b>619</b>	<b>667</b>
	<b>SQB18-20-AD</b> - _	square wood base with access door traditional base style empire series detailing WALNUT VENEER ONLY  <i>NOTCHED FOR WIRE MANAGEMENT</i>	20	20	27.75	class 70 cwt cu ft 2	<b>761</b>	<b>810</b>
	<b>SQB18-24-AD</b> - _	square wood base with access door traditional base style empire series detailing WALNUT VENEER ONLY  <i>NOTCHED FOR WIRE MANAGEMENT</i>	20	24	27.75	class 70 cwt cu ft 2	<b>761</b>	<b>810</b>
	<b>SQB18-30-AD</b> - _	square wood base with access door traditional base style empire series detailing WALNUT VENEER ONLY  <i>NOTCHED FOR WIRE MANAGEMENT</i>	30	30	27.75	class 70 cwt cu ft 3	<b>761</b>	<b>810</b>
	<b>SQB13-20</b> - _	square wood base traditional base style oxford series detailing CHERRY VENEER ONLY  <i>NOTCHED FOR WIRE MANAGEMENT</i>	20	20	29	class 70 cwt cu ft 2	<b>657</b>	<b>710</b>
	<b>SQB13-24</b> - _	square wood base traditional base style oxford series detailing CHERRY VENEER ONLY  <i>NOTCHED FOR WIRE MANAGEMENT</i>	20	24	29	class 70 cwt cu ft 2	<b>657</b>	<b>710</b>
	<b>SQB13-30</b> - _	square wood base traditional base style oxford series detailing CHERRY VENEER ONLY  <i>NOTCHED FOR WIRE MANAGEMENT</i>	30	30	29	class 70 cwt cu ft 3	<b>657</b>	<b>710</b>
	<b>SQB13-20-AD</b> - _	square wood base with access door traditional base style oxford series detailing CHERRY VENEER ONLY  <i>NOTCHED FOR WIRE MANAGEMENT</i>	20	20	29	class 70 cwt cu ft 2	<b>799</b>	<b>851</b>

conference

**veneer**  
bases only

- 2KL-W** sepia on walnut
- 3L-W** saddle on walnut
- 4L-W** dark mahogany on walnut
- 25M-W** mahogany on walnut
- 25B-W** ebony on walnut
- 25C-W** cherry on walnut
- 6LC-W** light cherry on cherry
- 7MC-W** medium cherry on cherry
- 8DC-W** dark cherry on cherry
- 9BC-W** burgundy cherry on cherry

select maple  
bases only

- 2ML** natural maple on maple
- 3ML** light maple on maple
- 4ML** medium maple on maple
- 5ML** cherry on maple on maple

maple finish options available only  
on select top shapes:

- crescent CTS, CTP, CTW, CTO
- circular CS, CP, CW, CO
- rectangular RS, RP, RW, RO
- racetrack RTS, RTP, RTV
- boat BS, BV
- octagonal OS, OV

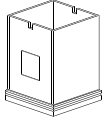
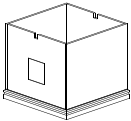
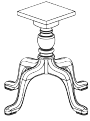
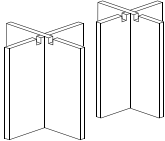
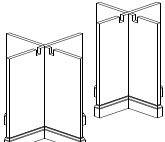
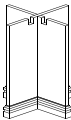
	model number		d	w	h	freight	list \$	zone 1	zone 2
	<b>SQB13-24-AD</b> - _	square wood base with access door traditional base style oxford series detailing CHERRY VENEER ONLY  <i>NOTCHED FOR WIRE MANAGEMENT</i>	20	24	29	class 70 cwt cu ft 2	<b>799</b>		<b>851</b>
	<b>SQB13-30-AD</b> - _	square wood base with access door traditional base style oxford series detailing CHERRY VENEER ONLY  notched for wire management	30	30	29	class 70 cwt cu ft 3	<b>799</b>		<b>851</b>
	<b>QA</b> - _	queen anne base	34	34	27.75	class 125 cwt 30 lb cu ft 12	<b>1,098</b>		<b>1,116</b>
	<b>XB-24</b> - _ <b>XB-30</b> - _ <b>XB-36</b> - _	wood "x" base	20 30 36	20 30 36	27.75 27.75 27.75	class 125 cwt 70 lb cu ft 5	<b>538</b> <b>605</b> <b>643</b>		<b>580</b> <b>656</b> <b>696</b>
	<b>XB18-24</b> - _ <b>XB18-30</b> - _ <b>XB18-36</b> - _  [ QS ]  Quick Ship available in 25M mahogany or 25C cherry	wood "x" traditional style base empire series detailing WALNUT VENEER ONLY  stone laminate "x" traditional style base empire series detailing	20 30 36	20 30 36	27.75 27.75 27.75	class 125 cwt 70 lb cu ft 5	<b>571</b> <b>638</b> <b>663</b>		<b>614</b> <b>690</b> <b>717</b>
	<b>XB13-24</b> - _ <b>XB13-30</b> - _ <b>XB13-36</b> - _	wood "x" traditional style base oxford series detailing CHERRY VENEER ONLY	20 30 36	20 30 36	27.75 27.75 27.75	class 125 cwt 70 lb cu ft 5	<b>629</b> <b>697</b> <b>721</b>		<b>679</b> <b>754</b> <b>783</b>

square bases can be made any depth down to 8" at standard price

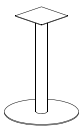
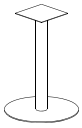
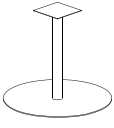
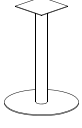
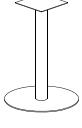
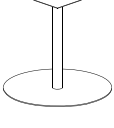
	model number	description	d	w	h	freight	zone 1	zone 2
	<b>PDB-20 -</b> _	post disc base powder coated "stardust" pedestal base HEIGHTS: 1 1/16" tops -28" height 1 1/4" tops - 27 3/4" height  <small>ALSO AVAILABLE IN BLACK</small>	20	20 dia.		class cwt cu ft	<b>860</b>	<b>928</b>
	<b>PDB-24 -</b> _	post disc base powder coated "stardust" pedestal base HEIGHTS: 1 1/16" tops -28" height 1 1/4" tops - 27 3/4" height  <small>ALSO AVAILABLE IN BLACK</small>	24	32 dia.		class cwt cu ft	<b>924</b>	<b>999</b>
	<b>PDB-32 -</b> _	post disc base powder coated "stardust" pedestal base HEIGHTS: 1 1/16" tops -28" height 1 1/4" tops - 27 3/4" height  <small>ALSO AVAILABLE IN BLACK</small>	32	32 dia.		class cwt cu ft	<b>1,131</b>	<b>1,221</b>
	<b>PDB-20-WM</b>	post disc base powder coated "stardust" pedestal base wire management HEIGHTS: 1 1/16" tops -28" height 1 1/4" tops - 27 3/4" height  <small>ALSO AVAILABLE IN BLACK</small>	20	20 dia.		class cwt cu ft	<b>1,073</b>	<b>1,159</b>
	<b>PDB-24-WM</b>	post disc base powder coated "stardust" pedestal base wire management HEIGHTS: 1 1/16" tops -28" height 1 1/4" tops - 27 3/4" height  <small>ALSO AVAILABLE IN BLACK</small>	24	30 dia.		class cwt cu ft	<b>1,136</b>	<b>1,229</b>
	<b>PDB-32-WM</b>	post disc base powder coated "stardust" pedestal base wire management HEIGHTS: 1 1/16" tops -28" height 1 1/4" tops - 27 3/4" height  <small>ALSO AVAILABLE IN BLACK</small>	32	32 dia.		class cwt cu ft	<b>1,345</b>	<b>1,452</b>

conference

**veneer**  
bases only





- 2KL-W** sepia on walnut
- 3L-W** saddle on walnut
- 4L-W** dark mahogany on walnut
- 25M-W** mahogany on walnut
- 25B-W** ebony on walnut
- 25C-W** cherry on walnut
- 6LC-W** light cherry on cherry
- 7MC-W** medium cherry on cherry
- 8DC-W** dark cherry on cherry
- 9BC-W** burgundy cherry on cherry

**veneer**  
select maple  
bases only

- 2ML** natural maple on maple
- 3ML** light maple on maple
- 4ML** medium maple on maple
- 5ML** cherry on maple on maple

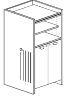
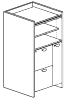
maple finish options available only  
on select top shapes:

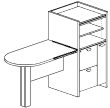
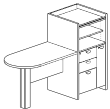
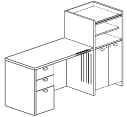
- crescent CTS, CTP, CTW, CTO
- circular CS, CP, CW, CO
- rectangular RS, RP, RW, RO
- racetrack RTS, RTP, RTV
- boat BS, BV
- octagonal OS, OV

	model number		d	w	h	freight	list \$	zone 1	zone 2
	<b>IP-CPU</b>	Podium alone with CPU storage	24	24	46	class cwt lb cu ft	<b>1,820</b>		1,966
	<b>IP-2F</b>	Podium alone with 2 file drawers and small hinged door	24	24	46	class cwt lb cu ft	<b>2,052</b>		<b>2,217</b>
	<b>IP-3D</b>	Podium alone with 2 box/1file drawer and small hinged door	24	24	46	class cwt lb cu ft	<b>2,138</b>		<b>2,309</b>
	<b>IP-BL (or BR)-CPU</b>	Podium/bullet top with CPU storage  (BL) bullet left or (BR) bullet right (left shown)  Bullet top is 42" long <i>WITH WOOD SUPPORT/MODESTY</i>	24	24	46	class cwt lb cu ft	<b>2,117</b>		<b>2,286</b>
	<b>IP-BL (or BR)-2F</b>	Podium/bullet top with 2 file drawers and hinged door storage  (BL) bullet left or (BR) bullet right (left shown)  Bullet top is 42" long <i>WITH WOOD SUPPORT/MODESTY</i>	24	24	46	class cwt lb cu ft	<b>2,350</b>		<b>2,539</b>
	<b>IP-BL (or BR)-3D</b>	Podium/bullet top with 2 box/1file drawer and small hinged door  (BL) bullet left or (BR) bullet right (left shown)  Bullet top is 42" long <i>WITH WOOD SUPPORT/MODESTY</i>	24	24	46	class cwt lb cu ft	<b>2,435</b>		2,630
	<b>IP-DL (or DR)-CPU</b>	Podium/return top desk with CPU storage  (DL) desk left or (DR) bullet desk (left shown)  Desk top is 42" long <i>3/4 BOX/FILE PEDESTAL/FULL MODESTY</i>	24	24	46	class cwt lb cu ft	3,209		<b>3,466</b>
	<b>IP-DL (or DR)-2F</b>	Podium/return top desk with 2 file drawers and hinged door storage  (DL) desk left or (DR) bullet desk (left shown)  Desk top is 42" long <i>3/4 BOX/FILE PEDESTAL/FULL MODESTY</i>	24	24	46	class cwt lb cu ft	3,443		<b>3,718</b>
	<b>IP-DL (or DR)-3D</b>	Podium/return top with 2 box/ 1 file drawer and small hinged door  (DL) desk left or (DR) bullet desk (left shown)  Desk top is 42" long <i>3/4 BOX/FILE PEDESTAL/FULL MODESTY</i>	24	24	46	class cwt lb cu ft	<b>3,527</b>		<b>3,810</b>

\* **CX bases** available with a flip top mechanism. add \$243 list upcharge

\* **wire management (WM)** not available in chrome or brushed steel

model number      description      d   w   h      freight      zone 1      zone 2

<p><b>veneer</b> bases only</p> <p><b>2KL-W</b> sepia on walnut  <b>3L-W</b> saddle on walnut  <b>4L-W</b> dark mahogany on walnut  <b>25M-W</b> mahogany on walnut  <b>25B-W</b> ebony on walnut  <b>25C-W</b> cherry on walnut  <b>6LC-W</b> light cherry on cherry  <b>7MC-W</b> medium cherry on cherry  <b>8DC-W</b> dark cherry on cherry  <b>9BC-W</b> burgundy cherry on cherry</p>	<p><b>veneer</b></p> <p><b>•2ML</b> natural maple on maple  <b>•3ML</b> light maple on maple  <b>•4ML</b> medium maple on maple  <b>•5ML</b> cherry on maple on maple</p>	<p>maple finish options available only on select top shapes:</p> <p>crescent    CTS, CTP, CTW, CTO  circular    CS, CP, CW, CO  rectangular    RS, RP, RW, RO  racetrack    RTS, RTP, RTV  boat        BS, BV  octagonal    OS, OV</p>
---	---	--



## RO9648-6LC-F

top shape (type) - top dimension - top option (materials) - top finish - edge shape





## VB-6LC

base option - base finish

### decorative inlay veneers

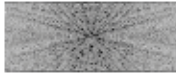
Enhance your conference area with the inclusion of a custom inlay top. Available in cherry, walnut, birch or maple veneers. 25 finish color options coordinate with all Inwood casegoods. Select from 40 base styles shown in the base section of the Inwood Price List.

Please allow for extended lead times. If you have any questions, please contact customer service at 800 786 6121.

	top shape	model number	d	w	cwt	cu ft
 <p>inlay rectangle starburst (BASES SOLD SEPARATELY)</p>		<b>ROTO7236</b>	72	36	105 lb 70	
		<b>ROTO9648</b>	96	48	185 lb 70	21
		<b>ROTO120</b>	120	48	235 lb 70	
		<b>ROTO144</b>	144	48	255 lb 70	
		<b>ROTO168</b>	168	48	300 lb 70	
		<b>ROTO9660</b>	96	60	200 lb 70	
		<b>ROTO12060</b>	120	60	260 lb 70	
	<b>ROTO16860</b>	168	60	320 lb 70	168	
 <p>inlay round starburst (BASES SOLD SEPARATELY)</p>		<b>CSTO36</b>	36	36	40 lb 70	3
		<b>CSTO42</b>	42	42	50 lb 70	
		<b>CSTO48</b>	48	48	60 lb 70	5
		<b>CSTO60</b>	60	60	75 lb 70	
 <p>inlay boat shape starburst (BASES SOLD SEPARATELY)</p>		<b>BOTO7236</b>	72	36	105 lb 70	
		<b>BOTO9648</b>	96	48	185 lb 70	
		<b>BOTO120</b>	120	48	235 lb 70	
		<b>BOTO144</b>	144	48	255 lb 70	32
 <p>inlay race track bordered starburst (BASES SOLD SEPARATELY)</p>		<b>RTBS07236</b>	72	36	105 lb 70	
		<b>RTBS09648</b>	96	48	185 lb 70	
		<b>RTBS0120</b>	120	48	235 lb 70	
		<b>RTBS0144</b>	144	48	255 lb 70	
 <p>inlay round bordered starburst (BASES SOLD SEPARATELY)</p>		<b>CBSO36</b>	36	36	40 lb 70	3
		<b>CBSO42</b>	42	42	50 lb 70	
		<b>CBSO48</b>	48	48	60 lb 70	5
		<b>CBSO60</b>	60	60	75 lb 70	

conference

#### wood top & edge finishes

<b>88M-W</b>	mahogany on cherry
<b>MB-W</b>	mocha on birch
<b>NB-W</b>	natural on birch
<b>CB-W</b>	cherry on birch
<b>3L-W</b>	saddle on walnut
<b>2KL-W</b>	sepia on walnut
<b>4L-W</b>	dark mahogany on walnut
<b>25M-W</b>	mahogany on walnut
<b>25B-W</b>	ebony on walnut
<b>25C-W</b>	cherry on walnut

#### wood top & edge finishes

<b>2ML-W</b>	natural maple on maple
<b>3ML-W</b>	light maple on maple
<b>4ML-W</b>	medium maple on maple
<b>5ML-W</b>	cherry on maple
<b>1NC-W</b>	natural cherry on cherry
<b>2HC-W</b>	honey cherry on cherry
<b>6LC-W</b>	light cherry on cherry
<b>7MC-W</b>	medium cherry on cherry
<b>8DC-W</b>	dark cherry on cherry
<b>9BC-W</b>	burgundy cherry on cherry

#### pvc edge color options

<b>BL</b>	black
<b>FG</b>	fog
<b>FS</b>	folkstone
<b>HZ</b>	haze
<b>LB</b>	light beige
<b>PD</b>	pepperdust
<b>SL</b>	slate

#### top

<b>W</b>	veneer top
<b>P</b>	laminated top
<b>GB</b>	ganging brackets (tables over 42" wide need 2) \$102 list ea.
<b>NS</b>	nester



2.25" thick tops (self edge) \$265 list upcharge (standard thickness 1.25")



laminated top SELF EDGE (S)		laminated top PVC EDGE (P)		laminated top WOOD EDGE (W)		SELF EDGE (V)		veneer top WOOD EDGE (O)	
list \$ zone 1	list \$ zone 2	list \$ zone 1	list \$ zone 2	list \$ zone 1	list \$ zone 2	list \$ zone 1	list \$ zone 2	list \$ zone 1	list \$ zone 2
								5,574	5,706
								8,016	8,249
								10,326	10,607
								12,836	13,125
								16,548	17,011
								8,587	8,966
								11,128	11,668
								18,140	18,813
								2,630	2,760
								3,129	3,266
								3,685	3,843
								4,785	5,056
								5,792	5,970
								7,775	8,006
								10,682	10,904
								13,260	13,480
								5,434	5,545
								8,592	8,958
								10,359	12,125
								12,125	12,346
								3,421	3,552
								4,183	4,320
								5,065	5,223
								7,168	7,438

conference

• maple finish option available on the following:  
**rectangular** - RS, RP, RW, RO  
**racetrack** - RTS, RTP, RTO  
**octagonal** - OS, OV  
**boat shape** - BS, BV, BO, BW  
**crenate** - CTS, CTP, CTW, CTO  
**circular** - CS, CP, CW, CO

**laminated** mocha on birch laminated natural on birch laminated  
 cherry on birch laminated  
 saddle on walnut  
 dark mahogany on walnut  
 mahogany on walnut  
 cherry on walnut bony on walnut light  
 cherry on cherry  
 medium cherry on cherry  
 dark cherry on cherry natural maple on maple  
 light maple on maple  
 medium maple on maple  
 cherry on maple on maple

**laminated** solid & mixed colors  
 top & edge finishes  
**BA**  
**BB**  
**BL**  
**CF**  
**CL**  
**CM**  
**CN**  
**CO**  
**CU**  
**EW**  
**GS**  
**GV**  
**NV**  
**OS**  
**RA**  
**SU**  
**TY**  
**WH**

black ashwood  
 bethany beige  
 black  
 copper fusion  
 chili  
 cardamom fiber  
 cinnamon  
 coriander fiber  
 curacao fiber  
 eggshell white  
 graphite spectrum  
 galvan  
 negotiating in geneva  
 olive serenity  
 rock of ages  
 sugar fiber  
 thyme fiber  
 wheat fiber

**laminated** top & edge finishes  
**Designer palette** (5% upcharge plus \$80 net freight charge)  
**SPL** special laminate, provide manufacturer and item # \_\_\_\_\_  
 birch veneer not available on tops for birch finishes, use maple veneer  
 6 week leadtime to run a one piece top with grain running long direction  
 list upcharges: 96"/\$1,044, 120"/\$1,116, 144"/\$1,565

# inwood

OFFICE  
ENVIRONMENTS

## price list

effective 01 january 2012

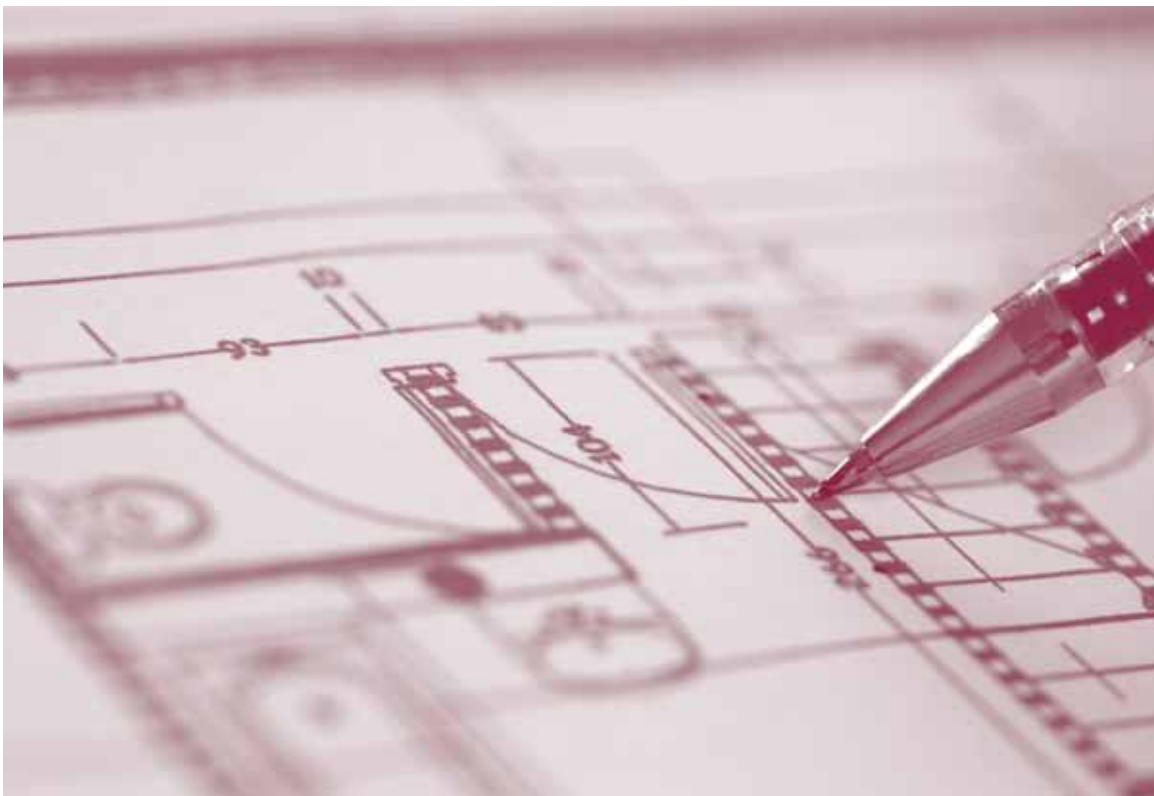

account # \_\_\_\_\_  
discount \_\_\_\_\_  
zone \_\_\_\_\_  
c.s.r. \_\_\_\_\_  
sales rep. \_\_\_\_\_

## seating

[click here for warranty  
and terms information](#)

zones one and two



# inwood

OFFICE  
ENVIRONMENTS

---



seating

**instructions for seating product are available online and within product cartons**

**online instructions**

Inwood Office Environments makes available the complete library of product instructions for seating and office furniture. Please visit [inwood.net](http://inwood.net) and click the "after purchase" link to review the down-loadable PDF documents. You'll also find information for the care and maintenance of your new inwood furniture. Any issues? Assistance is only a phone call away. Call 1-800-786-6121 for Inwood customer service. Our customer service representatives can talk you through most issues. Need professional service? We would be happy to suggest an authorized dealer or service technician within your area.

**c.o.m. (customer's own material)**

All seating can be upholstered with appropriate material furnished by the customer. All prices are listed under Grade 2.

Yardage requirements shown are based on the use of non-directional fabric 54" wide and the fabric being cut "up the roll." If the c.o.m. fabric is to be railroaded, please contact Customer Service for revised yardage requirements. Inwood reserves the right to inspect, approve or reject any c.o.m. fabric. Once approved, Inwood cannot assume responsibility or liability for the durability, tailoring, appearance, or other qualities of customer furnished coverings.

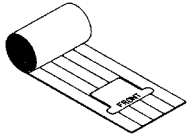

pattern cut "up the roll"

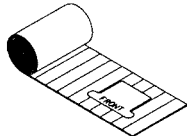

pattern cut "railroaded"

**all com orders must**

- Include a 3 inch x 3 inch swatch of the fabric stapled to the purchase order, indicating which side is to be exposed
- Indicate whether application is vertical or horizontal if fabric has a pattern or stripe
- Include fabric supplier's name, fabric number, and color
- Be approved by Inwood. DO NOT ship c.o.m fabric until customer service has notified you of the acceptability of your fabric
- Be shipped prepaid and marked with your company name, purchase order number, and any special instructions

Orders for items using c.o.m. cannot be put into a production schedule until the fabric is received. The date that c.o.m. is received will be considered the actual date of the order.

COL (customers on leather) use grade 4.

**fabric cut yardage/list price per yard**

<b>grade 1</b>	\$32
<b>grade 2</b>	\$35
<b>grade 3</b>	\$47
<b>grade 4</b>	\$52
<b>grade 5</b>	\$60
<b>grade 6</b>	\$65
<b>grade 7</b>	\$72

**inwood fabric graded-in program**

Dye lots may vary slightly from samples shown. All fabrics are 54" wide. Prices are subject to change without notice. All figures are in U.S. dollars.

## mayer fabrics:

### samples

Mayer contract seating fabrics have been graded in to the Inwood standard program. To view the full line of available fabric patterns and colorways, please visit [www.mayerfabrics.com](http://www.mayerfabrics.com) or call 800.428.4415 direct for samples. **The fabrics and faux leathers listed in bold are those on the inwood cards.**

pattern	grade	pattern	grade
<i>fabric offering</i>		<i>faux leather offering</i>	
acanthus	7	<b>antique</b>	<b>6</b>
amulet	3	<b>caressa fr</b>	<b>5</b>
amulet plus DuraBlock™	6	<b>caressa suede</b>	<b>6</b>
astro	6	durango	3
bijou	5	emu	5
<b>broadway</b>	<b>6</b>	<b>florentino</b>	<b>3</b>
<b>catalyst</b>	<b>5</b>	<b>jekyll &amp; hyde**</b>	<b>6</b>
celebration	5	kobe	5
clarity	5	komodo	5
classic velvet	7	<b>maverick</b>	<b>3</b>
component	7	<b>outback</b>	<b>4</b>
cornerstone	4	<b>phoenix</b>	<b>7</b>
cross check	3	radiance	7
decade crepe 10	7	santa ana	6
decade orion 10	7		
Destiny	3	<i>vinyl offering</i>	
Destiny plus DuraBlock™	6	all seasons (fr)	5
duraweave® 10	2	all use (fr)	3
<b>element</b>	<b>3</b>	athens (fr)	7
<b>equation</b>	<b>6</b>	blocks	5
essential	4	chaps (fr)	6
factor [RPI]	7	<b>curlicue</b>	<b>6</b>
figure eight [RPI]	5	currents	6
fiigree [RPI]	7	<b>dokata</b>	<b>7</b>
flourish	5	<b>dublin tweed (fr)</b>	<b>7</b>
flying high [R60+]	7	<b>guardian (n)</b>	<b>7</b>
forte	1	heather (fr)	7
<b>foundation 10 [RPC]</b>	<b>3</b>	jamestown	3
genesis	3	key largo	4
genesis plus DuraBlock™	6	linen	5
glee	7	madrid sp black	1
heritage	5	<b>microdot</b>	<b>6</b>
high society	7	oxen sp black	1
impulse [RPI]	6	<b>peerless</b>	<b>7</b>
in the groove	7	<b>pinehurst</b>	<b>7</b>
jubilee	5	<b>prado</b>	<b>7</b>
<b>lunar [RPI]</b>	<b>5</b>	punch (n)	6
marquise [R60+]	5	sierra sp black	1
moonscape [RPI]	6	silk screen	7
mum	3	<b>silverweave</b>	<b>7</b>
mosaic	3	tiles	7
mosaic plus DuraBlock™	6	<b>toss up</b>	<b>7</b>
mum	3	<b>tributary</b>	<b>7</b>
mum plus DuraBlock™	6	<b>tussah</b>	<b>7</b>
mystic [RPI]	7	uptown	6
over the top [R60+]	7	ventura	6
<b>paramount</b>	<b>4</b>	wallaby sp black	1
quattro	3	willow	5
rapport	7		
regency	7	<i>woven crypton</i>	
revival	5	metro	7
sojourn	3		
sojourn plus DuraBlock™	6		
spacer mesh	4		
straight & narrow [R60+]	7		
structure	5		
sunset strip	5		
taj	5		
tendril	3		
tendril plus DuraBlock™	6		
valor	3		
valor plus DuraBlock™	6		
vineta	4		
wave length	4		

\***bold** = standard on inwood card  
**fr** fire resistant  
**[r]** 100% recycled Terratex®  
**{r}** recycled ECOSYSTEM collection®  
**10** a 10 year warranty

## momentum fabrics:

### samples

momentum fabrics have been graded into the Inwood standard program. To view the full line of available fabric patterns and colorways, please visit [www.themomgroup.com](http://www.themomgroup.com) or call 800-366-6836 direct for samples.

pattern	grade	pattern	grade
agora	4	pinpoint	2
array	5	pivio	1
<b>axis</b>	<b>2</b>	prodigy	5
basis	1	prompt	5
boom	5	racer	5
bravo	7	ratio	2
cachet	3	realm	7
canter	5	rein	5
cashmere	3	relic	7
core	1	reverie	2
cre (crete)	5	ringo	5
era	4	<b>russo</b>	<b>2</b>
etch	5	sassy	2
expo	1	saucy	5
factor	5	savant	7
fleck	5	schema	7
form	5	sector	4
glg	7	sequence	7
glam	5	simplex	7
gusto	5	snippet	3
hue	4	solo	7
Insight	1	solo	7
impact	5	stance	5
intermix	7	streamline	7
interval	2	sublime	5
jargon	2	tact	7
jinx	5	tangent	2
kayo	1	tatami	5
knack	4	tate	2
marquee	7	tease	7
max	7	transit	4
mer (mercury)	5	trek	2
mime	3	valet	7
mimic	5	vario	7
moda	2	venue	7
nook	2	verge	5
<b>origin</b>	<b>1</b>	vox	2
<b>perk</b>	<b>1</b>		

seating









\***bold** = standard on inwood card  
**fr** fire resistant  
**[r]** 100% recycled Terratex®  
**{r}** recycled ECOSYSTEM collection®  
**10** a 10 year warranty

\*\* Jekyll & Hyde is designed to simulate a natural leather that features shade variation and “beauty marks” formed from wrinkles, stretch marks and usage. The effects that will occur with this Faux Leather product are purposefully intended to mimic those of real leather and are not defects in the product.

guest and lounge

model number + finish + upholstery

call 1 800 786 6121 for any questions about ordering your Inwood seating

	model number	description	freight	com/col	upholstery	zone 1 list \$	zone 2 list \$
	<b>SC12</b>	captain's chair upholstered arms nail trim  <b>d</b> <b>w</b> <b>h</b> 23.25   24   30	cwt 26 lb cu ft 11	yds 1.75	grade 1 grade 2/com grade 3 grade 4/col grade 5 grade 6 grade 7	<b>1,242</b> <b>1,254</b> <b>1,259</b> <b>1,270</b> <b>1,282</b> <b>1,284</b> <b>1,292</b>	<b>1,342</b> <b>1,353</b> <b>1,360</b> <b>1,372</b> <b>1,384</b> <b>1,387</b> <b>1,395</b>
	<b>SC12C</b>	captain's chair with casters upholstered arms nail trim  <b>d</b> <b>w</b> <b>h</b> 23.25   24   30	cwt 26 lb cu ft 11	yds 1.75	grade 1 grade 2/com grade 3 grade 4/col grade 5 grade 6 grade 7	<b>1,354</b> <b>1,364</b> <b>1,370</b> <b>1,381</b> <b>1,393</b> <b>1,396</b> <b>1,403</b>	<b>1,462</b> <b>1,474</b> <b>1,480</b> <b>1,491</b> <b>1,506</b> <b>1,508</b> <b>1,515</b>
	<b>SC41</b>	guest chair upholstered arms nail trim  <b>d</b> <b>w</b> <b>h</b> 23.25   25   30	cwt 26 lb cu ft 11	yds 1.75	grade 1 grade 2/com grade 3 grade 4/col grade 5 grade 6 grade 7	<b>1,211</b> <b>1,221</b> <b>1,226</b> <b>1,238</b> <b>1,250</b> <b>1,253</b> <b>1,259</b>	<b>1,307</b> <b>1,319</b> <b>1,325</b> <b>1,336</b> <b>1,350</b> <b>1,353</b> <b>1,360</b>
	<b>SC41C</b>	guest chair with casters button upholstery details open back  <b>d</b> <b>w</b> <b>h</b> 23.25   25   30	cwt 32 lb cu ft 16	yds 1.75	grade 1 grade 2/com grade 3 grade 4/col grade 5 grade 6 grade 7	<b>1,390</b> <b>1,401</b> <b>1,407</b> <b>1,417</b> <b>1,430</b> <b>1,432</b> <b>1,439</b>	<b>1,502</b> <b>1,514</b> <b>1,519</b> <b>1,531</b> <b>1,544</b> <b>1,546</b> <b>1,556</b>
	<b>SC61</b>	guest chair open wood arms medium back  <b>d</b> <b>w</b> <b>h</b> 26   26.5   33.75	cwt 30 lb cu ft 16	yds 2.00	grade 1 grade 2/com grade 3 grade 4/col grade 5 grade 6 grade 7	<b>2,276</b> <b>2,288</b> <b>2,295</b> <b>2,306</b> <b>2,322</b> <b>2,324</b> <b>2,332</b>	<b>2,458</b> <b>2,470</b> <b>2,478</b> <b>2,491</b> <b>2,507</b> <b>2,509</b> <b>2,518</b>
	<b>SC59</b>	guest chair open wood arms medium back  <b>d</b> <b>w</b> <b>h</b> 28   26.75   36.5	cwt 32 lb cu ft 16	yds 2.00	grade 1 grade 2/com grade 3 grade 4/col grade 5 grade 6 grade 7	<b>1,980</b> <b>1,992</b> <b>1,998</b> <b>2,011</b> <b>2,025</b> <b>2,028</b> <b>2,036</b>	<b>2,139</b> <b>2,151</b> <b>2,158</b> <b>2,172</b> <b>2,187</b> <b>2,191</b> <b>2,199</b>
	<b>SC55</b>	guest chair open wood arms medium back  <b>d</b> <b>w</b> <b>h</b> 27.5   26   36.5	cwt 30 lb cu ft 16	yds 2.00	grade 1 grade 2/com grade 3 grade 4/col grade 5 grade 6 grade 7	<b>2,040</b> <b>2,051</b> <b>2,058</b> <b>2,071</b> <b>2,085</b> <b>2,088</b> <b>2,096</b>	<b>2,203</b> <b>2,216</b> <b>2,224</b> <b>2,236</b> <b>2,252</b> <b>2,254</b> <b>2,263</b>
	<b>SC47</b>	guest chair upholstered closed arms wood fronts  <b>d</b> <b>w</b> <b>h</b> 27   26   35	cwt 55 lb cu ft 16.2	yds 3.00	grade 1 grade 2/com grade 3 grade 4/col grade 5 grade 6 grade 7	<b>2,909</b> <b>2,926</b> <b>2,937</b> <b>2,955</b> <b>2,976</b> <b>2,980</b> <b>2,993</b>	<b>3,141</b> <b>3,161</b> <b>3,172</b> <b>3,192</b> <b>3,214</b> <b>3,219</b> <b>3,232</b>

wood

**2 ML-W** natural maple on maple  
**3 ML-W** light maple on maple  
**4 ML-W** medium maple on maple  
**5 ML-W** cherry on maple on maple









**1 NC-W** natural cherry on cherry  
**2 HC-W** honey cherry on cherry  
**6 LC-W** light cherry on cherry  
**7 MC-W** medium cherry on cherry  
**8 DC-W** dark cherry on cherry  
**9 BC-W** burgundy cherry on cherry

**2 KL-W** sepia on walnut  
**3 L-W** saddle on walnut  
**25 C-W** cherry on walnut  
**25 B-W** ebony on walnut

**25 M-W** mahogany on walnut  
**88 M-W** mahogany on cherry  
**4 L-W** dark mahogany on walnut

**MB-W** mocha on birch  
**CB-W** cherry on birch  
**NB** natural birch on birch



	model number	description	freight	com/col	upholstery	zone 1 list \$	zone 2 list \$
	<b>SC20</b>	guest chair open wood arms low back  <b>d</b> <b>w</b> <b>h</b> 24.5   23    31.5	cwt 30 lb cu ft 13.5	yds 1.75	grade 1 grade 2/com grade 3 grade 4/col grade 5 grade 6 grade 7	<b>1,570</b> <b>1,581</b> <b>1,586</b> <b>1,596</b> <b>1,610</b> <b>1,612</b> <b>1,619</b>	<b>1,695</b> <b>1,706</b> <b>1,714</b> <b>1,725</b> <b>1,738</b> <b>1,741</b> <b>1,748</b>
	<b>SC22</b>	guest chair upholstered closed arms wood fronts and caps  <b>d</b> <b>w</b> <b>h</b> 24.5   24    31.5	cwt 30 lb cu ft 13.5	yds 2.00	grade 1 grade 2/com grade 3 grade 4/col grade 5 grade 6 grade 7	<b>1,972</b> <b>1,984</b> <b>1,990</b> <b>2,003</b> <b>2,017</b> <b>2,020</b> <b>2,028</b>	<b>2,130</b> <b>2,143</b> <b>2,150</b> <b>2,163</b> <b>2,179</b> <b>2,181</b> <b>2,191</b>
[ QS ] 	<b>SC101</b> <small>Quick Ship available in 8DC dark cherry with grade 2 Momentum Axis Truffle fabric</small>	guest chair open wood arms fully upholstered back  <b>d</b> <b>w</b> <b>h</b> 24    24.25   33.5	cwt 30 lb cu ft 16	yds 1.25	grade 1 grade 2/com grade 3 grade 4/col grade 5 grade 6 grade 7	<b>591</b> <b>599</b> <b>604</b> <b>610</b> <b>619</b> <b>620</b> <b>626</b>	<b>638</b> <b>646</b> <b>653</b> <b>659</b> <b>668</b> <b>670</b> <b>675</b>
[ QS ] 	<b>SC106</b> <small>Quick Ship available in #2 honey cherry with grade 1 Momentum Origin Eco fabric</small>	guest chair open wood arms partial wood insert  <b>d</b> <b>w</b> <b>h</b> 24    24.25   33.5	cwt 30 lb cu ft 16	yds 1.00	grade 1 grade 2/com grade 3 grade 4/col grade 5 grade 6 grade 7	<b>554</b> <b>557</b> <b>559</b> <b>561</b> <b>565</b> <b>565</b> <b>567</b>	<b>599</b> <b>602</b> <b>604</b> <b>607</b> <b>610</b> <b>611</b> <b>613</b>
	<b>SC406</b>	guest chair open wood arms partial wood insert <small>FRAMES ARE SLIGHTLY DIFFERENT THAN THE NEWLY INTRODUCED 106.</small>  <b>d</b> <b>w</b> <b>h</b> 24    24.25   33.5	cwt 30 lb cu ft 16	yds 1.00	grade 1 grade 2/com grade 3 grade 4/col grade 5 grade 6 grade 7	<b>554</b> <b>557</b> <b>559</b> <b>561</b> <b>565</b> <b>565</b> <b>567</b>	<b>599</b> <b>602</b> <b>604</b> <b>607</b> <b>610</b> <b>611</b> <b>613</b>
	<b>SC109</b>	gues chair open wood arms partial wood insert  <b>d</b> <b>w</b> <b>h</b> 24    24.25   33.5	cwt 30 lb cu ft 16	yds 1.00	grade 1 grade 2/com grade 3 grade 4/col grade 5 grade 6 grade 7	<b>554</b> <b>557</b> <b>559</b> <b>561</b> <b>565</b> <b>565</b> <b>567</b>	<b>599</b> <b>602</b> <b>604</b> <b>607</b> <b>610</b> <b>611</b> <b>613</b>
	<b>SC409</b>	gues chair open wood arms partial wood insert <small>FRAMES ARE SLIGHTLY DIFFERENT THAN THE NEWLY INTRODUCED 106.</small>  <b>d</b> <b>w</b> <b>h</b> 24    24.25   33.5	cwt 30 lb cu ft 16	yds 1.00	grade 1 grade 2/com grade 3 grade 4/col grade 5 grade 6 grade 7	<b>554</b> <b>557</b> <b>559</b> <b>561</b> <b>565</b> <b>565</b> <b>567</b>	<b>599</b> <b>602</b> <b>604</b> <b>607</b> <b>610</b> <b>611</b> <b>613</b>
	<b>SC113</b>	guest chair open wood arms partially upholstered back  <b>d</b> <b>w</b> <b>h</b> 24    24.25   33.5	cwt 30 lb cu ft 16	yds 1.00	grade 1 grade 2/com grade 3 grade 4/col grade 5 grade 6 grade 7	<b>560</b> <b>565</b> <b>569</b> <b>575</b> <b>582</b> <b>583</b> <b>588</b>	<b>605</b> <b>611</b> <b>615</b> <b>620</b> <b>629</b> <b>630</b> <b>634</b>









\*NOTE: DUE TO NOTICABLE SEAMS LIGHT FINISHES ARE NOT RECOMMENDED FOR THE SC101 CHAIR

Greenguard Certification has been awarded to some of inwood office environments guest seating line.



The GREENGUARD Environmental Institute (GEI), a highly respected resource on indoor air quality, established the GREENGUARD Certification ProgramSM in 2001. As an industry independent, non-profit organization, GEI develops rigorous, consensus-based standards for indoor air quality (IAQ) following globally recognized scientific methods. Decades of experience led to establishing the GREENGUARD product certification programs. These programs apply strict chemical emissions standards to ensure the acceptability of products for use indoors. Only products achieving these high standards are approved to bear the GREENGUARD Indoor Air Quality Certified mark. [www.greenguard.org](http://www.greenguard.org)

 - Greenguard Certified Items

	model number	description	freight	com/col	upholstery	zone 1 list \$	zone 2 list \$
	<b>SC413</b>	guest chair open wood arms partially upholstered back <small>FRAMES ARE SLIGHTLY DIFFERENT THAN THE NEWLY INTRODUCED 106.</small> <b>d w h</b> 24 24.25 33.5	cwt 30 lb cu ft 16	yds 1.00	grade 1 grade 2/com grade 3 grade 4/col grade 5 grade 6 grade 7	<b>560</b> <b>565</b> <b>569</b> <b>575</b> <b>582</b> <b>583</b> <b>588</b>	<b>605</b> <b>611</b> <b>615</b> <b>620</b> <b>629</b> <b>630</b> <b>634</b>
	<b>SC404A</b>	guest chair open arms fully upholstered back <b>d w h</b> 22 22 33	cwt 30 lb cu ft 16	yds 1.25	grade 1 grade 2/com grade 3 grade 4/col grade 5 grade 6 grade 7	<b>733</b> <b>741</b> <b>746</b> <b>752</b> <b>761</b> <b>763</b> <b>768</b>	<b>792</b> <b>800</b> <b>805</b> <b>813</b> <b>822</b> <b>823</b> <b>829</b>
[ QS ] 	<b>SC404B</b> <small>Quick Ship available in #7 medium cherry with grade 1 Momentum Origin Bayou fabric</small>	guest chair open wood arms slat back <b>d w h</b> 22 22 33	30 lb 16	yds 1.00	grade 1 grade 2/com grade 3 grade 4/col grade 5 grade 6 grade 7	<b>649</b> <b>653</b> <b>655</b> <b>658</b> <b>661</b> <b>662</b> <b>664</b>	<b>701</b> <b>705</b> <b>708</b> <b>710</b> <b>714</b> <b>715</b> <b>717</b>
[ QS ] 	<b>SC505A</b> <small>Quick Ship available in 8DC dark cherry with grade 2 Momentum Russon Imperial fabric</small>	guest chair open wood arms fully upholstered back <b>d w h</b> 22 23 36.5	cwt 30 lb cu ft 16	yds 1.25	grade 1 grade 2/com grade 3 grade 4/col grade 5 grade 6 grade 7	<b>726</b> <b>734</b> <b>740</b> <b>746</b> <b>755</b> <b>757</b> <b>762</b>	<b>785</b> <b>794</b> <b>799</b> <b>805</b> <b>816</b> <b>817</b> <b>823</b>
	<b>SC505B</b>	guest chair open wood arms half upholstered back <b>d w h</b> 22 23 36.5	cwt 30 lb cu ft 16	yds 1.00	grade 1 grade 2/com grade 3 grade 4/col grade 5 grade 6 grade 7	<b>674</b> <b>681</b> <b>685</b> <b>691</b> <b>698</b> <b>699</b> <b>704</b>	<b>728</b> <b>735</b> <b>741</b> <b>746</b> <b>753</b> <b>754</b> <b>760</b>
[ QS ] 	<b>SC505C</b> <small>Quick Ship available in 25M mahogany with grade 4 Mayer Paramount Khaki fabric or 25C cherry with grade 4 Mayer Paramount Admiral fabric</small>	guest chair open wood arms "bella" design back <b>d w h</b> 22 23 36.5	cwt 30 lb cu ft 16	yds 1.00	grade 1 grade 2/com grade 3 grade 4/col grade 5 grade 6 grade 7	<b>639</b> <b>641</b> <b>643</b> <b>646</b> <b>649</b> <b>651</b> <b>653</b>	<b>690</b> <b>693</b> <b>695</b> <b>698</b> <b>701</b> <b>702</b> <b>705</b>
	<b>SC505D</b>	guest chair open wood arms "vase" design back <b>d w h</b> 22 23 36.5	cwt 40 lb cu ft 16.2	yds 1.00	grade 1 grade 2/com grade 3 grade 4/col grade 5 grade 6 grade 7	<b>639</b> <b>641</b> <b>643</b> <b>646</b> <b>649</b> <b>651</b> <b>653</b>	<b>690</b> <b>693</b> <b>695</b> <b>698</b> <b>701</b> <b>702</b> <b>705</b>
	<b>SC606A</b>	guest chair open wood arms fully upholstered back <b>d w h</b> 26 23 32.75	cwt 26 lb cu ft 16	yds 1.25	grade 1 grade 2/com grade 3 grade 4/col grade 5 grade 6 grade 7	<b>667</b> <b>674</b> <b>680</b> <b>686</b> <b>696</b> <b>697</b> <b>702</b>	<b>720</b> <b>728</b> <b>734</b> <b>742</b> <b>746</b> <b>753</b> <b>759</b>

wood









**2 ML-W** natural maple on maple  
**3 ML-W** light maple on maple  
**4 ML-W** medium maple on maple  
**5 ML-W** cherry on maple on maple

**1 NC-W** natural cherry on cherry  
**2 HC-W** honey cherry on cherry  
**6 LC-W** light cherry on cherry  
**7 MC-W** medium cherry on cherry  
**8 DC-W** dark cherry on cherry  
**9 BC-W** burgundy cherry on cherry

**2 KL-W** sepia on walnut  
**3 L-W** saddle on walnut  
**25 C-W** cherry on walnut  
**25 B-W** ebony on walnut

**25 M-W** mahogany on walnut  
**88 M-W** mahogany on cherry  
**4 L-W** dark mahogany on walnut

**MB-W** mocha on birch  
**CB-W** cherry on birch  
**NB** natural birch on birch







	model number	description	freight	com/col	upholstery	zone 1 list \$	zone 2 list \$
[ QS ] 	<b>SC606B</b> Quick Ship available in #2 natural maple with grade 2 Momentum Origin Amethyst fabric	guest chair open wood arms square cut back  <b>d</b> <b>w</b> <b>h</b> 26   23   32.75	cwt 26 lb cu ft 16	yds 1.00	grade 1 grade 2/com grade 3 grade 4/col grade 5 grade 6 grade 7	<b>658</b> <b>661</b> <b>663</b> <b>665</b> <b>669</b> <b>669</b> <b>671</b>	<b>710</b> <b>714</b> <b>716</b> <b>718</b> <b>722</b> <b>723</b> <b>725</b>
[ QS ] 	<b>SC707A</b> Quick Ship available in MB mocha with grade 4 Paramount Stucco fabric	guest chair open wood arms fully upholstered back  <b>d</b> <b>w</b> <b>h</b> 25   22.5   34.5	cwt 30 lb cu ft 13.5	1.25	grade 1 grade 2/com grade 3 grade 4/col grade 5 grade 6 grade 7	<b>749</b> <b>757</b> <b>762</b> <b>768</b> <b>777</b> <b>778</b> <b>784</b>	<b>808</b> <b>817</b> <b>823</b> <b>829</b> <b>839</b> <b>842</b> <b>847</b>
	<b>SC707B</b>	guest chair open wood arms "hourglass" design back  <b>d</b> <b>w</b> <b>h</b> 25   22.5   34.5	cwt 30 lb cu ft 16	yds 1.00	grade 1 grade 2/com grade 3 grade 4/col grade 5 grade 6 grade 7	<b>665</b> <b>668</b> <b>670</b> <b>673</b> <b>677</b> <b>678</b> <b>680</b>	<b>719</b> <b>722</b> <b>724</b> <b>726</b> <b>728</b> <b>732</b> <b>734</b>
	<b>SC707C</b>	guest chair open wood arms "hourglass" design back  <b>d</b> <b>w</b> <b>h</b> 25   22.5   34.5	cwt 30 lb cu ft 16	yds 1.00	grade 1 grade 2/com grade 3 grade 4/col grade 5 grade 6 grade 7	<b>665</b> <b>668</b> <b>670</b> <b>673</b> <b>677</b> <b>678</b> <b>680</b>	<b>719</b> <b>722</b> <b>724</b> <b>726</b> <b>728</b> <b>732</b> <b>734</b>
	<b>SC707D</b>	guest chair open wood arms square cut back  <b>d</b> <b>w</b> <b>h</b> 25   22.5   34.5	cwt 30 lb cu ft 16	yds 1.00	grade 1 grade 2/com grade 3 grade 4/col grade 5 grade 6 grade 7	<b>665</b> <b>668</b> <b>670</b> <b>673</b> <b>677</b> <b>678</b> <b>680</b>	<b>719</b> <b>722</b> <b>724</b> <b>726</b> <b>728</b> <b>732</b> <b>734</b>
[ QS ] 	<b>SC707E</b> Quick Ship available in 25M mahogany with grade 1 Momentum Perk Sesame fabric	guest chair open wood arms x back  <b>d</b> <b>w</b> <b>h</b> 25   22.5   34.5	30 lb 16	yds 1.00	grade 1 grade 2/com grade 3 grade 4/col grade 5 grade 6 grade 7	<b>639</b> <b>642</b> <b>644</b> <b>646</b> <b>649</b> <b>651</b> <b>653</b>	<b>690</b> <b>693</b> <b>695</b> <b>698</b> <b>701</b> <b>702</b> <b>705</b>
	<b>SC45</b>	guest chair tufted seat and back wood arms nail trim  <b>d</b> <b>w</b> <b>h</b> 30   26   42.5	cwt 40 lb cu ft 16.2	yds 2.50	grade 1 grade 2/com grade 3 grade 4/col grade 5 grade 6 grade 7	<b>2,913</b> <b>2,928</b> <b>2,937</b> <b>2,951</b> <b>2,969</b> <b>2,973</b> <b>2,982</b>	<b>3,147</b> <b>3,162</b> <b>3,171</b> <b>3,188</b> <b>3,207</b> <b>3,211</b> <b>3,221</b>
	<b>SC39</b>	guest chair open wood arms medium back  <b>d</b> <b>w</b> <b>h</b> 25.75   24   36.5	cwt 26 lb cu ft 16	yds 2.00	grade 1 grade 2/com grade 3 grade 4/col grade 5 grade 6 grade 7	<b>1,849</b> <b>1,860</b> <b>1,867</b> <b>1,880</b> <b>1,893</b> <b>1,897</b> <b>1,905</b>	<b>1,996</b> <b>2,010</b> <b>2,017</b> <b>2,031</b> <b>2,045</b> <b>2,048</b> <b>2,057</b>

Greenguard Certification has been awarded to some of inwood office environments guest seating line.

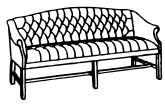

The GREENGUARD Environmental Institute (GEI), a highly respected resource on indoor air quality, established the GREENGUARD Certification ProgramSM in 2001. As an industry independent, non-profit organization, GEI develops rigorous, consensus-based standards for indoor air quality (IAQ) following globally recognized scientific methods. Decades of experience led to establishing the GREENGUARD product certification programs. These programs apply strict chemical emissions standards to ensure the acceptability of products for use indoors. Only products achieving these high standards are approved to bear the GREENGUARD Indoor Air Quality Certified mark. [www.greenguard.org](http://www.greenguard.org)

 - Greenguard Certified Items

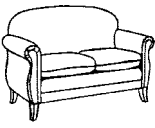
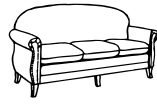
	model number	description	freight	com/col	upholstery	zone 1 list \$	zone 2 list \$
	SC355	guest chair top arm upholstered fully upholstered back  d w h 27.75 26.25 36.5	cwt 26 lb cu ft 16	yds 2.75	grade 1 grade 2/com grade 3 grade 4/col grade 5 grade 6 grade 7	1,960 1,978 1,986 2,003 2,023 2,026 2,038	2,118 2,136 2,145 2,163 2,184 2,189 2,201
	CC18	club chair tufted seat and back nail trim  d w h 26.5 27.75 31.25	cwt 35 lb cu ft 14.5	yds 3.00	grade 1 grade 2/com grade 3 grade 4/col grade 5 grade 6 grade 7	2,484 2,501 2,797 2,530 2,551 2,555 2,567	2,682 2,702 2,712 2,732 2,755 2,759 2,773
	CC18C	club chair with casters tufted seat and back nail trim  d w h 26.5 27.75 31.25	cwt 35 lb cu ft 14.5	yds 3.00	grade 1 grade 2/com grade 3 grade 4/col grade 5 grade 6 grade 7	2,614 2,632 2,643 2,660 2,682 2,686 2,699	2,822 2,843 2,854 2,872 2,896 2,900 2,914
	LS18	loveseat tufted seat and back nail trim  d w h 26.5 49.5 33.25	cwt 65 lb cu ft 30	yds 5.00	grade 1 grade 2/com grade 3 grade 4/col grade 5 grade 6 grade 7	3,617 3,649 3,664 3,694 3,731 3,737 3,758	3,907 3,940 3,957 3,989 4,029 4,036 4,059
	SF19	sofa tufted seat and back nail trim  d w h 26.5 72.75 33.25	cwt 85 lb cu ft 42	yds 6.00	grade 1 grade 2/com grade 3 grade 4/col grade 5 grade 6 grade 7	4,405 4,441 4,461 4,498 4,541 4,549 4,574	4,757 4,797 4,818 4,857 4,904 4,912 4,940
	CC58	lounge chair loose cushion wood legs nail trim  d w h 29 34.5 39	cwt 76 lb cu ft 28	yds 7.00	grade 1 grade 2/com grade 3 grade 4/col grade 5 grade 6 grade 7	3,369 3,413 3,435 3,477 3,528 3,537 3,566	3,639 3,685 3,710 3,757 3,811 3,820 3,852
	LS58	loveseat loose cushions wood legs nail trim  d w h 29 55 39	cwt 94 lb cu ft 44.5	yds 8.50	grade 1 grade 2/com grade 3 grade 4/col grade 5 grade 6 grade 7	4,396 4,448 4,475 4,527 4,588 4,599 4,635	4,747 4,803 4,833 4,889 4,955 4,966 5,005
	SF58	sofa loose cushions wood legs nail trim  d w h 29 78 39	cwt 127 lb cu ft 62	yds 10.50	grade 1 grade 2/com grade 3 grade 4/col grade 5 grade 6 grade 7	5,239 5,302 5,336 5,401 5,475 5,490 5,534	5,657 5,726 5,762 5,832 5,914 5,929 5,975

wood









- 2 ML-W natural maple on maple
- 3 ML-W light maple on maple
- 4 ML-W medium maple on maple
- 5 ML-W cherry on maple on maple

- 1 NC-W natural cherry on cherry
- 2 HC-W honey cherry on cherry
- 6 LC-W light cherry on cherry
- 7 MC-W medium cherry on cherry
- 8 DC-W dark cherry on cherry
- 9 BC-W burgundy cherry on cherry

- 2 KL-W sepia on walnut
- 3 L-W saddle on walnut
- 25 C-W cherry on walnut
- 25 B-W ebony on walnut

- 25 M-W mahogany on walnut
- 88 M-W mahogany on cherry
- 4 L-W dark mahogany on walnut

- MB-W mocha on birch
- CB-W cherry on birch
- NB natural birch on birch

	model number	description	freight	com/col	upholstery	zone 1 list \$	zone 2 list \$
	SW50	management tilt/swivel open wood arms gas lift control  d    w    h 29   26   36-38.5	cwt 55 lb cu ft 12.3	yds 2.00	grade 1 grade 2/com grade 3 grade 4/col grade 5 grade 6 grade 7	2,748 2,759 2,765 2,778 2,792 2,795 2,804	2,967 2,979 2,988 3,000 3,016 3,019 3,027
	SW52	management tilt/swivel black neoprene arms adjustable seat height  d    w    h 30.5   25.25   35.75-39	cwt 45 lb cu ft 12.3	yds 2.00	grade 1 grade 2/com grade 3 grade 4/col grade 5 grade 6 grade 7	1,920 1,933 1,939 1,951 1,966 1,968 1,977	2,074 2,087 2,094 2,106 2,123 2,126 2,134
	SW23	executive tilt/swivel open wood arms adjustable seat height nail trim  d    w    h 30.5   26.5   41-43.75	cwt 60 lb cu ft 16.2	yds 3.00	grade 1 grade 2/com grade 3 grade 4/col grade 5 grade 6 grade 7	3,309 3,326 3,336 3,356 3,376 3,380 3,394	3,574 3,592 3,604 3,624 3,648 3,652 3,664
	SW45	executive tilt/swivel open wood arms adjustable seat height nail trim  d    w    h 29.5   26   41-44	cwt 55 lb cu ft 16.2	yds 2.50	grade 1 grade 2/com grade 3 grade 4/col grade 5 grade 6 grade 7	3,274 3,290 3,298 3,313 3,331 3,334 3,345	3,536 3,553 3,561 3,578 3,598 3,602 3,612
	SW324	executive tilt/swivel open wood/upholstered arms gas lift control  d    w    h 32   26   43-46	cwt 63 lb cu ft 16.2	yds 3.50	grade 1 grade 2/com grade 3 grade 4/col grade 5 grade 6 grade 7	3,370 3,392 3,403 3,424 3,450 3,454 3,469	3,639 3,663 3,675 3,698 3,725 3,730 3,745
	SW40	executive tilt/swivel fully upholstered arms gas lift control  d    w    h 29   26   42.25-45.25	cwt 63 lb cu ft 16.2	yds 3.50	grade 1 grade 2/com grade 3 grade 4/col grade 5 grade 6 grade 7	3,018 3,040 3,051 3,072 3,097 3,102 3,115	3,259 3,282 3,295 3,317 3,345 3,350 3,365
	SW34	executive tilt/swivel black neoprene arms adjustable seat height wood caps on base  d    w    h 30   26.5   46-49	cwt 61 lb cu ft 16.2	yds 3.75	grade 1 grade 2/com grade 3 grade 4/col grade 5 grade 6 grade 7	3,321 3,345 3,357 3,379 3,406 3,412 3,427	3,587 3,612 3,625 3,651 3,679 3,684 3,702
	SW47	executive tilt/swivel upholstered arm/wood front gas lift control wood caps on base  d    w    h 30.75   28.25   40.5-43	cwt 48 lb cu ft 16.2	yds 3.25	grade 1 grade 2/com grade 3 grade 4/col grade 5 grade 6 grade 7	3,475 3,496 3,506 3,525 3,549 3,553 3,566	3,754 3,774 3,786 3,808 3,833 3,837 3,852

Greenguard Certification has been awarded to some of inwood office environments guest seating line.



The GREENGUARD Environmental Institute (GEI), a highly respected resource on indoor air quality, established the GREENGUARD Certification ProgramSM in 2001. As an industry independent, non-profit organization, GEI develops rigorous, consensus-based standards for indoor air quality (IAQ) following globally recognized scientific methods. Decades of experience led to establishing the GREENGUARD product certification programs. These programs apply strict chemical emissions standards to ensure the acceptability of products for use indoors. Only products achieving these high standards are approved to bear the GREENGUARD Indoor Air Quality Certified mark. [www.greenguard.org](http://www.greenguard.org)

 - Greenguard Certified Items



model number	description	freight	com/col	upholstery	zone 1 list \$	zone 2 list \$	
<b>SW35</b>	management tilt/swivel	cwt 55 lb cu ft 16.2	yds 2.75	grade 1	<b>2,652</b>	<b>2,864</b>	
	top arm upholstered			grade 2/com	<b>2,669</b>	<b>2,884</b>	
	fully upholstered back	grade 3		<b>2,679</b>	<b>2,893</b>		
	gas lift control	grade 4/col		<b>2,695</b>	<b>2,911</b>		
	wood base	grade 5		<b>2,714</b>	<b>2,933</b>		
	<b>d</b>	<b>w</b>		<b>h</b>	grade 6	<b>2,719</b>	<b>2,937</b>
	30.75	26.25		39	grade 7	<b>2,730</b>	<b>2,948</b>

wood

<b>2 ML-W</b> natural maple on maple	<b>1 NC-W</b> natural cherry on cherry	<b>2 KL-W</b> sepia on walnut	<b>25 M-W</b> mahogany on walnut
<b>3 ML-W</b> light maple on maple	<b>2 HC-W</b> honey cherry on cherry	<b>3 L-W</b> saddle on walnut	<b>88 M-W</b> mahogany on cherry
<b>4 ML-W</b> medium maple on maple	<b>6 LC-W</b> light cherry on cherry	<b>25 C-W</b> cherry on walnut	<b>4 L-W</b> dark mahogany on walnut
<b>5 ML-W</b> cherry on maple on maple	<b>7 MC-W</b> medium cherry on cherry	<b>25 B-W</b> ebony on walnut	<b>MB-W</b> mocha on birch
	<b>8 DC-W</b> dark cherry on cherry		<b>CB-W</b> cherry on birch
	<b>9 BC-W</b> burgundy cherry on cherry		<b>NB</b> natural birch on birch

# inwood

OFFICE  
ENVIRONMENTS

## price list

effective 01 january 2012

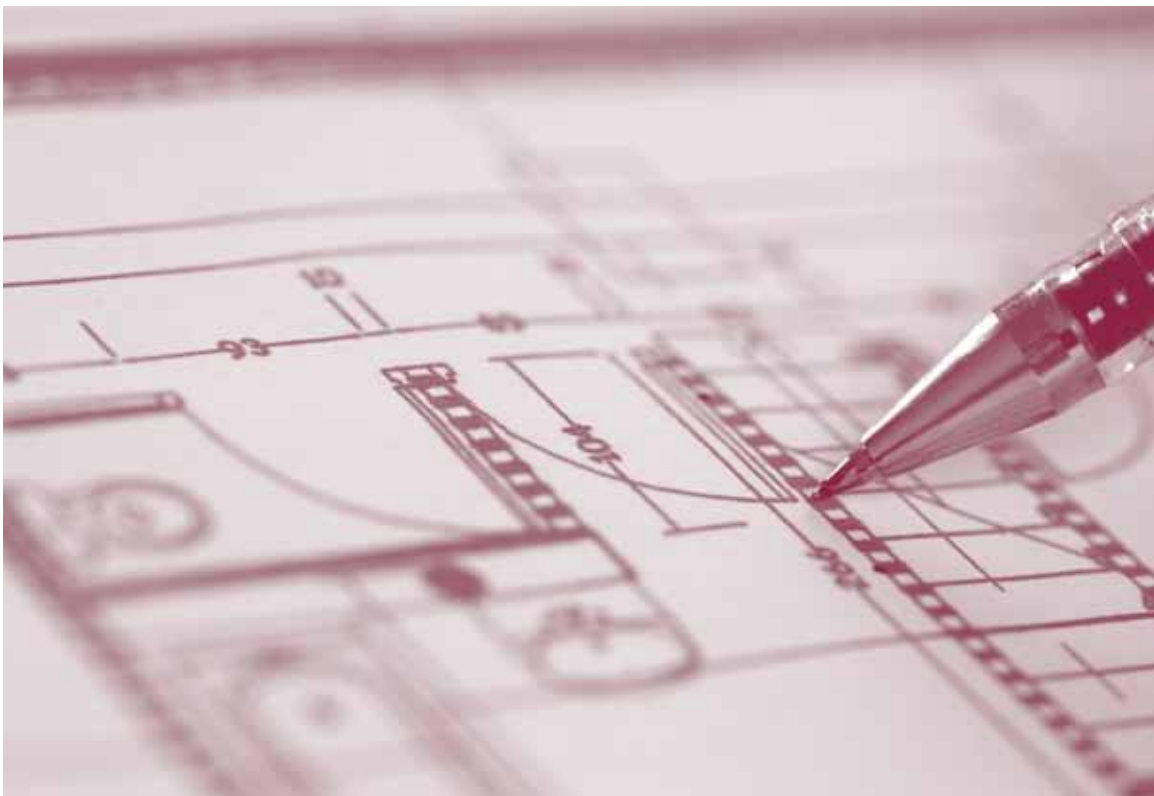

account # \_\_\_\_\_  
discount \_\_\_\_\_  
zone \_\_\_\_\_  
c.s.r. \_\_\_\_\_  
sales rep. \_\_\_\_\_

## accessories

[click here for warranty  
and terms information](#)

zones one and two







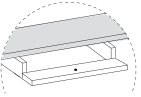



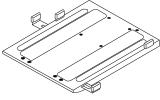
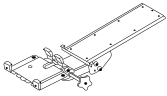
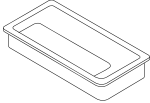

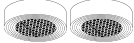

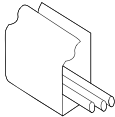

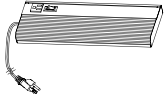

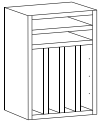
	model number	description	d	w	h	freight	list \$	zone 1	zone 2
	<b>MT</b>	fold out and tilting mouse tray for right hand or left hand  <i>FOR USE WITH KBP, FIELD INSTALLATION ONLY</i>				100 cwt 5 lb cu ft .5	<b>180</b>		<b>194</b>
	<b>CDP</b> <b>CDP-I</b>	center drawer black plastic  <i>CANNOT BE FACTORY INSTALLED IN BRIDGES, CORNER UNITS OR ANY TREK 2500 SURFACES. PLEASE SPECIFY UNIT ON WHICH TO BE INSTALLED FACTORY INSTALLED ONLY</i>	19	24.3	1.8	class 100 cwt 5 lb cu ft 1	<b>197</b>		<b>197</b>
	<b>CDP-14</b> <b>CDP-14-I</b>	center drawer black plastic for use with 20" units  <i>CANNOT BE FACTORY INSTALLED IN BRIDGES, CORNER UNITS OR ANY TREK 2500 SURFACES. PLEASE SPECIFY UNIT ON WHICH TO BE INSTALLED. FACTORY INSTALLED ONLY</i>	17	14	1.8	class 100 cwt 5 lb cu ft 1	<b>197</b>		<b>197</b>
	<b>CDA-24</b>	wood center drawer	20	20	2	class 100 cwt 8 lb cu ft 1	<b>279</b>		<b>300</b>
	<b>KBCD-I</b>	keyboard drawer with lock styled as center drawer with drop front drawer pulls out for keyboard use *indicate which series (NOT available in Muse, Progeny, Trek or Brio)  <i>FACTORY INSTALLED ONLY, SPECIFY GROMMET LOCATION</i>	14		4	cwt lb	<b>585</b>		<b>585</b>
	<b>KBP</b> <b>KBP-I</b>	plastic keyboard platform  <i>ARTICULATING KEYBOARD CONTROLS HEIGHT ADJUSTMENT FROM 26.5" - 29" CANNOT BE FACTORY INSTALLED IN BRIDGES, CORNER UNITS OR ANY TREK 2500 SURFACES. PLEASE SPECIFY UNIT ON WHICH TO BE INSTALLED FACTORY INSTALLED ONLY</i>	11	23	1.25	100 cwt 10 lb cu ft .5	<b>377</b>		<b>419</b>
	<b>KBMT</b> <b>KBMT-I</b>	keyboard mechanism with clamp tray adjustable wrist rest and swivel mouse arm; black Wrist - 10.5"x3"x20.5" Mouse - 7 5/16" x 7 5/16" Arm - 10.5" x 4.5" x 19"  <i>HEIGHT ADJUSTABLE FROM 26.5 - 29" FACTORY INSTALLED ONLY</i>				class 100 cwt 15 lb cu ft 1	<b>742</b>		<b>801</b>

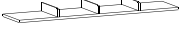

accessories

	model number	description		freight	list \$ zone 1	list \$ zone 2
	<b>LTKB</b> <b>LTKB-I</b>	laptop keyboard holder slides back into kneespace when lap top is closed; adjustable height and tilt; side clamps adjust to individual lap top size; black  <i>FACTORY INSTALLED ONLY</i>		class 100 cwt 10 lb cu ft .5	<b>593</b>	<b>641</b>
	<b>KBCM</b> <b>KBCM-I</b>	keyboard mechanism with articulating control mechanism clamps on to keyboard; eliminates the need for trays to hold keyboard; keyboard is mounted under work surface; black  <i>HEIGHT ADJUSTABLE FROM 26.5" TO 29"</i> <i>FACTORY INSTALLED ONLY</i>	10 - 4.25	class 100 cwt 10 cu ft .5	<b>343</b>	<b>370</b>
	<b>RGS-I</b>	rectangular black grommet accepts almost any size plug or cords  <i>FACTORY INSTALLED ONLY,</i> <i>SPECIFY LOCATION</i>	4 2 -	class cwt lb cu ft	<b>156</b>	<b>156</b>
	<b>Accent</b>	Accent lights to go inside overhead storage units  Price for only 1 light		class cwt lb cu ft	<b>408</b>	<b>408</b>
	<b>Accent 2</b>	Accent light for the inside overhead storage unit  Pricing for 2 lights		class cwt lb cu ft	<b>494</b>	<b>494</b>
	<b>Accent 3</b>	Accent light for inside overhead storage unit  Pricing for 3 lights		class cwt lb cu ft	<b>610</b>	<b>610</b>
	<b>WMC-30</b>	wire/cable management conduit 2.25" x 1" black plastic wire/cable conduit; secures to kneespace or under tops with double sided tape; top opens for wires/cables to slip in and be concealed; customer can cut to length	- 30 -	class cwt lb cu ft	<b>122</b>	<b>132</b>

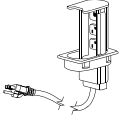
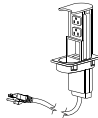
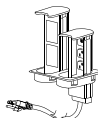
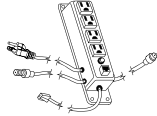
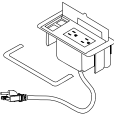

	model number	description	d	w	h	freight	list \$	zone 1	zone 2
	TL24	task light for use with overhead storage units  <i>FIELD INSTALLED ONLY</i>	7	24	2	class 100 cwt 11 lb cu ft 1	335		364
	CPU	vertical off the floor fixed mount CPU holder 360° swivel supports up to 45 lbs steel construction, black finish  <i>FIELD INSTALLED ONLY</i> <i>VERTICAL STORAGE: 14.5 - 22.5"</i> <i>HORIZONTAL ADJUSTMENT: 5.25 - 9.5"</i>				class 100 cwt 15 cu ft 1	391		391
	CPU-T	vertical off the floor fixed mount CPU holder 360° swivel supports up to 45 lbs steel construction, black finish *for thinner CPU's  <i>FIELD INSTALLED ONLY</i> <i>VERTICAL STORAGE: 14.5 - 22.5"</i> <i>HORIZONTAL ADJUSTMENT: 2.75 - 5.5"</i>				class 100 cwt 15 lb cu ft 1	379		379
	PSU	personal storage units universal style horizontal or vertical positioning  <i>SPECIFY FINISH</i>	12	15.5	21.75	class 125 cwt 20 cu ft 2	675		728
	USU84 - _	underside paper storage unit mounts under overhead cabinet with 5 storage compartments does not prevent use of task lights or tacboards not available with wall mount units  <i>FACTORY INSTALLED</i>	15.5	82	4	class cwt lb cu ft	512		554
	USU72	underside paper storage unit mounts under overhead cabinet 4 storage compartments; does not prevent the use of task lights or tack boards; not available on wall mount units  <i>FACTORY INSTALLED</i>	15.5	70	4	class cwt lb cu ft	498		536
	USU66	underside paper storage unit 4 storage compartments; does not prevent the use of task lights or tack boards; not available on wall mount units  <i>FACTORY INSTALLED</i>	15.5	64	4	class cwt cu ft	498		536

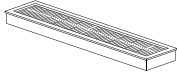
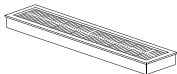
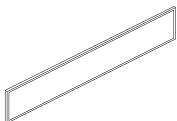
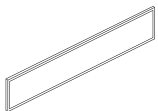
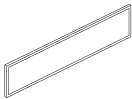
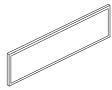
accessories

	model number	description		freight	list \$ zone 1	list \$ zone 2
	<b>USU48</b> - _	underside paper storage unit mounts under overhead cabinet 3 storage compartments; does not prevent the use of task lights or tackboards; not available on wall mount units  <i>FACTORY INSTALLED</i>	15.5 46 4	class lb	<b>292</b>	<b>315</b>
	<b>USU36</b> - _	underside paper storage unit mounts under overhead cabinet 2 storage compartments; does not prevent the use of task lights or tackboards; not available on wall mount units  <i>FACTORY INSTALLED</i>	15.5 34 4	class cwt cu ft	<b>292</b>	<b>315</b>
	<b>PPM</b> <b>PPM-I</b>	pop-up power supply management three 10 amp circuit breaker simplex outlets; black  6 FOOT POWER CORD PLEASE SPECIFY LOCATION <i>FACTORY INSTALLED ONLY</i>		class cwt lb cu ft	<b>442</b>	<b>442</b>
	<b>PPC</b> <b>PPC-I</b>	pop-up power supply management two 10 amp circuit breaker simplex outlets; one adapter face plate; one voice/data adapter kit to accept voice/data couplers and jacks (sold separately) separates power and data; black  6 FOOT POWER CORD PLEASE SPECIFY LOCATION <i>FACTORY INSTALLED ONLY</i>		class cwt lb cu ft	<b>442</b>	<b>442</b>
	<b>PCC</b> <b>PCC-I</b>	pop-up power and communications center three 15 amp simplex outlets; two adapter face plates; two voice/data adapter kit to accept voice/data couplers and jacks (sold separately) 10 amp circuit breaker; black  6 FOOT POWER CORD PLEASE SPECIFY LOCATION <i>FACTORY INSTALLED ONLY</i>		class cwt lb cu ft	<b>498</b>	<b>498</b>
	<b>PCH</b>	power communications harness mounts in any knee-well or any panel 13 amp circuit breaker; 120 volt, 60hz, 13 amp ratings; 10' power cord; 105 c; 16/3 13 amp; 14' telephone hook up for phone, modem or fax; black  <i>UL NETED CSD CERTIFIED FIELD INSTALLED ONLY</i>		class cwt lb	<b>265</b>	<b>265</b>
	<b>FPM</b> <b>FPM-I</b>	flip-up power management with two simplex outlets and two communication blanks; black  <i>PLEASE SPECIFY LOCATION FACTORY INSTALLED ONLY</i>		class lb	<b>538</b>	<b>538</b>

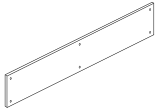
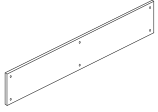
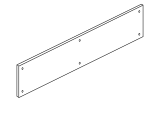
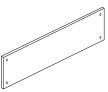

	model number	description	d	w	h	freight	list \$ zone 1	zone 2
	<b>BRKIT1</b> <b>BRKIT1-I</b>	18" brush wire management grommet <i>FACTORY INSTALLED ONLY PLEASE SPECIFY LOCATION</i>				class cwt lb cu ft	<b>513</b>	<b>513</b>
	<b>BRKIT2</b> <b>BRKIT2-I</b>	two 18" brush wire management grommet <i>FACTORY INSTALLED ONLY PLEASE SPECIFY LOCATION</i>				class cwt lb cu ft	<b>985</b>	<b>985</b>
	<b>WMTB-84</b> - __ - __	84" wide wall mount tackboard; wood frame with khaki color fabric standard specify edge option COM Yardage: 2.5 Yards  <i>SEE PAGE 504 FOR ADDITIONAL FABRIC OPTIONS</i>	1.25	84	18.5	class 125 cwt 15 lb cu ft 1	<b>Gr 1 712</b> <b>Gr 2 715</b> <b>Gr 3 738</b> <b>Gr 4 749</b> <b>Gr 5 763</b> <b>Gr 6 773</b> <b>Gr 7 785</b>	<b>Gr 1 769</b> <b>Gr 2 772</b> <b>Gr 3 798</b> <b>Gr 4 808</b> <b>Gr 5 824</b> <b>Gr 6 834</b> <b>Gr 7 848</b>
	<b>WMTB-72</b> - __ - __	72" wide wall mount bulletin board tackboard; wood frame with khaki color fabric standard please specify edge option COM Yardage: 2.25 yards  <i>SEE PAGE 504 FOR ADDITIONAL FABRIC OPTIONS</i>	1.25	72	18.5	class 125 cwt 15 cu ft 1	<b>Gr 1 669</b> <b>Gr 2 677</b> <b>Gr 3 698</b> <b>Gr 4 707</b> <b>Gr 5 720</b> <b>Gr 6 731</b> <b>Gr 7 743</b>	<b>Gr 1 722</b> <b>Gr 2 731</b> <b>Gr 3 754</b> <b>Gr 4 763</b> <b>Gr 5 778</b> <b>Gr 6 789</b> <b>Gr 7 801</b>
	<b>WMTB-66</b> - __ - __	66" wide wall mount bulletin board tackboard; wood frame with khaki color fabric standard please specify edge option COM Yardage: 2 yards  <i>SEE PAGE 504 FOR ADDITIONAL FABRIC OPTIONS</i>	1.25	66	18.5	class 125 cwt 15 lb cu ft 1	<b>Gr 1 648</b> <b>Gr 2 655</b> <b>Gr 3 671</b> <b>Gr 4 679</b> <b>Gr 5 690</b> <b>Gr 6 697</b> <b>Gr 7 707</b>	<b>Gr 1 701</b> <b>Gr 2 707</b> <b>Gr 3 724</b> <b>Gr 4 733</b> <b>Gr 5 745</b> <b>Gr 6 754</b> <b>Gr 7 763</b>
	<b>WMTB-48</b> - __ - __	48" wide wall mount bulletin board tackboard; wood frame with khaki color fabric standard please specify edge option COM Yardage: 1.5 yards  <i>SEE PAGE 504 FOR ADDITIONAL FABRIC OPTIONS</i>	1.25	48	18.5	class 125 cwt 15 lb cu ft 1	<b>Gr 1 587</b> <b>Gr 2 591</b> <b>Gr 3 604</b> <b>Gr 4 609</b> <b>Gr 5 617</b> <b>Gr 6 624</b> <b>Gr 7 630</b>	<b>Gr 1 633</b> <b>Gr 2 639</b> <b>Gr 3 653</b> <b>Gr 4 658</b> <b>Gr 5 666</b> <b>Gr 6 672</b> <b>Gr 7 681</b>
	<b>WMTB-36</b> - __ - __	36" wide wall mount tackboard; wood frame with khaki color fabric standard specify edge option COM Yardage: 1.25 Yards  <i>SEE PAGE 504 FOR ADDITIONAL FABRIC OPTIONS</i>	1.25	36	18.5	class 125 cwt 15 lb cu ft 1	<b>Gr 1 545</b> <b>Gr 2 549</b> <b>Gr 3 561</b> <b>Gr 4 566</b> <b>Gr 5 575</b> <b>Gr 6 581</b> <b>Gr 7 588</b>	<b>Gr 1 588</b> <b>Gr 2 592</b> <b>Gr 3 606</b> <b>Gr 4 612</b> <b>Gr 5 620</b> <b>Gr 6 628</b> <b>Gr 7 634</b>

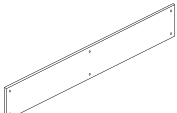
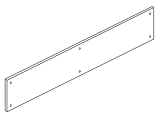
accessories



	model number	description		freight	list \$ zone 1	list \$ zone 2
	<b>TB84</b> - _ - _	84" wide tackboard khaki color fabric standard for use with overhead storage units  COM Yardage: 2.5 Yards <i>SEE PAGE 504 FOR ADDITIONAL FABRIC OPTIONS</i>	.75 84 16	class 100 cwt 5 lb cu ft 1	Gr 1 410 Gr 2 419 Gr 3 442 Gr 4 451 Gr 5 465 Gr 6 476 Gr 7 488	Gr 1 444 Gr 2 453 Gr 3 476 Gr 4 487 Gr 5 502 Gr 6 514 Gr 7 527
	<b>TB72</b> - _ - _	72" wide tackboard; khaki color fabric standard for use with overhead storage units  COM Yardage: 2.25 Yards <i>SEE PAGE 504 FOR ADDITIONAL FABRIC OPTIONS</i>	.75 72 16	class 100 5 lb cu ft 1	Gr 1 388 Gr 2 396 Gr 3 416 Gr 4 425 Gr 5 439 Gr 6 450 Gr 7 460	Gr 1 419 Gr 2 426 Gr 3 450 Gr 4 459 Gr 5 474 Gr 6 486 Gr 7 498
	<b>TB66</b> - _	66" wide tack board khaki color fabric standard use with overhead storage units  COM Yardage: 2 Yards <i>SEE PAGE 504 FOR ADDITIONAL FABRIC OPTIONS</i>	.75 66 16	class cwt lb cu ft	Gr 1 367 Gr 2 372 Gr 3 390 Gr 4 397 Gr 5 407 Gr 6 416 Gr 7 424	Gr 1 396 Gr 2 402 Gr 3 421 Gr 4 427 Gr 5 440 Gr 6 449 Gr 7 458
	<b>TB-48</b> - _ - _	48" wide wall mount bulletin board tackboard; wood frame with khaki color fabric standard please specify edge option  COM Yardage: 1.5 Yards <i>SEE PAGE 504 FOR ADDITIONAL FABRIC OPTIONS</i>	1.25 48 18.5	class 125 cwt 15 lb 1	Gr 1 267 Gr 2 281 Gr 3 289 Gr 4 298 Gr 5 315 Gr 6 317 Gr 7 323	Gr 1 289 Gr 2 302 Gr 3 312 Gr 4 322 Gr 5 341 Gr 6 343 Gr 7 349
	<b>TB-36</b> - _ - _	36" wide wall mount bulletin board tackboard; wood frame with khaki color fabric standard please specify edge option  COM Yardage: 1.25 Yards <i>SEE PAGE 504 FOR ADDITIONAL FABRIC OPTIONS</i>	1.25 48 18.5	class 125 cwt 15 lb cu ft 1	Gr 1 203 Gr 2 215 Gr 3 223 Gr 4 234 Gr 5 250 Gr 6 256 Gr 7 259	Gr 1 218 Gr 2 233 Gr 3 242 Gr 4 253 Gr 5 270 Gr 6 275 Gr 7 282
	<b>TBFH84</b> - _ - _	84" wide tackboard for use with "FH" overhead storage units standard khaki color fabric standard  COM Yardage: 1.5 Yards <i>SEE PAGE 504 FOR ADDITIONAL FABRIC OPTIONS</i>	.75 48 16	class 100 cwt 5 lb cu ft 1	Gr 1 267 Gr 2 275 Gr 3 296 Gr 4 306 Gr 5 317 Gr 6 326 Gr 7 339	Gr 1 289 Gr 2 298 Gr 3 319 Gr 4 329 Gr 5 343 Gr 6 353 Gr 7 366
	<b>TBFH72</b> - _ - _	72" wide tackboard for use with "FH" overhead storage units khaki color fabric standard  COM Yardage: 1.25 Yards <i>SEE PAGE 504 FOR ADDITIONAL FABRIC OPTIONS</i>	.75 36 16	class 100 cwt 5 lb cu ft 1	Gr 1 203 Gr 2 211 Gr 3 232 Gr 4 241 Gr 5 254 Gr 6 264 Gr 7 274	Gr 1 218 Gr 2 228 Gr 3 249 Gr 4 260 Gr 5 273 Gr 6 286 Gr 7 297

	model number	description	d	w	h	freight	list \$ zone 1	zone 2
	TBFH66 - _ - _	66" wide tackboard for use with "FH" overhead storage units khaki color fabric standard  COM Yardage: 1 Yard  <i>SEE PAGE 504 FOR ADDITIONAL FABRIC OPTIONS</i>	.75	30	16	class 100 cwt 5 cu ft 1	<b>Gr 1 175</b> <b>Gr 2 184</b> <b>Gr 3 204</b> <b>Gr 4 213</b> <b>Gr 5 226</b> <b>Gr 6 238</b> <b>Gr 7 248</b>	<b>Gr 1 190</b> <b>Gr 2 198</b> <b>Gr 3 219</b> <b>Gr 4 231</b> <b>Gr 5 244</b> <b>Gr 6 257</b> <b>Gr 7 268</b>
	Nester -84	Nester is the latch that allows the table to flip 84" requires a double latch Black standard color. Cannot be used with Genu-Fold mechanism  Table/legs/modesty ordered separately				class 125 15 lb 1	<b>1,121</b>	<b>1,212</b>
	Nester -72	Nester is the latch that allows the table to flip 72" requires a double latch Black standard color. Cannot be used with Genu-Fold mechanism  <i>TABLE/LEGS/MODESTY ORDERED SEPARATELY</i>				class 125 cwt 15 lb cu ft 1	<b>1,121</b>	<b>1,212</b>
	Nester -60	Nester is the latch that allows the table to flip 60" requires a single latch Black standard color. Cannot be used with Genu-Fold mechanism  <i>TABLE/LEGS/MODESTY ORDERED SEPARATELY</i>				class 125 15 lb 1	<b>875</b>	<b>946</b>
	Nester -48	Nester is the latch that allows the table to flip 48" requires a single latch Black standard color. Cannot be used with Genu-Fold mechanism  <i>TABLE/LEGS/MODESTY ORDERED SEPARATELY</i>				class 125 cwt 15 cu ft 1	<b>875</b>	<b>946</b>
	Nester-MH	Modesty Hinge for Nester Hinge only for any size Nester (pr)				class cwt cu ft	<b>164</b>	<b>177</b>
	Nester-84M	84" Modesty panel for Nester  <i>SPECIFY FINISH</i>				class cwt lb cu ft	<b>614</b>	<b>663</b>



accessories

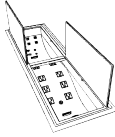
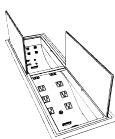
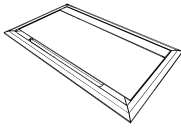

	model number	description	freight	list \$ zone 1	list \$ zone 2
	<b>Nester-72M</b>	72" Modesty panel for Nester <i>SPECIFY FINISH</i>	class lb	<b>503</b>	<b>542</b>
	<b>Nester-60M</b>	60" Modesty panel for Nester <i>SPECIFY FINISH</i>	class cwt lb	<b>381</b>	<b>412</b>
	<b>Nester-48M</b>	48" Modesty panel for Nester <i>SPECIFY FINISH</i>	class cwt lb cu ft	<b>241</b>	<b>259</b>



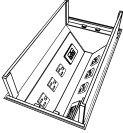
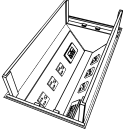
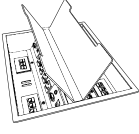

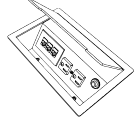

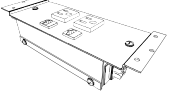

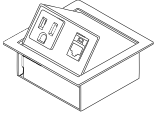
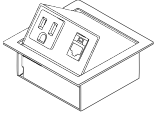
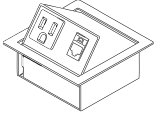

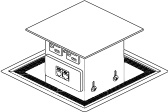

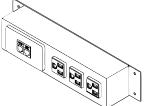
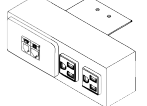
	model number	description	list \$ zone 1	list \$ zone 2
	<b>ELECTRI-WAVE</b>	30" decorative table trough with 12 power receptacles, 12 RJ45 Cat 6 connectors, 2 mini-stereo connectors, 2 15 pin VGA HD connectors, 2 DVI Connectors and 2 USB Universal Type A/B connectors. Rim of LED's can be activated for accent lighting. Constructed of powder coated steel with brushed aluminum bezel and frosted glass doors.  <i>INCLUDES A 72" CORD WITH MOLDED PLUG AND 20 AMP CIRCUIT BREAKER.</i>	<b>11,664</b>	<b>11,664</b>
	<b>ELECTRI-WAVE 1</b>	12 power receptacles, 6 RJ45 Cat 6 connectors, 1 mini-stereo connectors, 1 15 pin VGA HD connectors, 1 DVI Connectors and 1 USB Universal Type A/B connectors.	<b>7,674</b>	<b>7,674</b>
	<b>ELECTRI-WAVE MINI</b>	1 table trough and frosted glass lid with 6 power receptacles, 6 RJ45 cat 6 data jacks, 1 15 pin VGA and 1 mini-stereo connector for easy connectivity to the most popular devices.	<b>4,592</b>	<b>4,592</b>
	<b>OASIS B-S(silver)</b> <b>OASIS B- BL (black)</b>	Oasis 30" trough with 8 power receptacles and cutouts for 6 telecom plates. Telecom plates purchased separately. Available in two colors; silver pearl finish with brushed and anodized aluminum lids and bezels or ebony finish with black anodized aluminum lids and bezel. UL listed.  Optional "pan" for housing the wires \$185  <i>CALL CUSTOMER SERVICE FOR PRICING ON SPECIFIED TELECOM PLATES</i>	<b>5,515</b>	<b>5,515</b>
	<b>OASIS B-PC-S (silver)</b> <b>OASIS B-PC- BL (black)</b>	Oasis 30" trough with 8 power receptacles and cutouts for 6 telecom plates. Telecom plates purchased separately. Available in two colors; all metal with black powder coated lids or all metal with silver powder coated lids. UL listed.  Optional "pan" for housing the wires \$185  <i>CALL CUSTOMER SERVICE FOR PRICING ON SPECIFIED TELECOM PLATES</i>	<b>3,676</b>	<b>3,676</b>

accessories





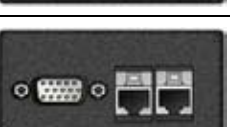
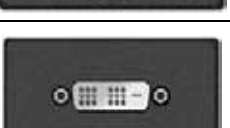
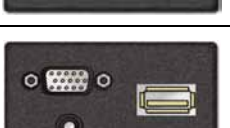

			list \$ zone 1	list \$ zone 2
	<b>OASIS MINI A-S (silver)</b> <b>OASIS-MINI A -BL (black)</b>	Oasis-Mini 15" trough with 6 power receptacles and 2 telecom plate cutouts. Telecom plates purchased separately. Available in two colors: silver pearl finish with brushed anodized aluminum lids and bezels or ebony finish with black anodized aluminum lids and bezel. UL Listed.  Optional "pan" for housing wires \$111  <i>CALL CUSTOMER SERVICE FOR PRICING ON SPECIFIED TELECOM PLATES</i>	<b>3,060</b>	<b>3,060</b>
	<b>OASIS MINI A-PC-S (silver)</b> <b>OASIS-MINI A -PC-BL (black)</b>	Oasis-Mini 15" trough with 6 power receptacles and 2 telecom plate cutouts. Telecom plates purchased separately. Available in two colors: All metal with silver powder coat lids or all metal with black powder coat lids UL Listed.  Optional "pan" for housing wires \$111  <i>CALL CUSTOMER SERVICE FOR PRICING ON SPECIFIED TELECOM PLATES</i>	<b>2,138</b>	<b>2,138</b>
	<b>INTRFC II TT SC</b> <b>INTRFC II TT SC-PC-S (silver)</b> <b>INTRFC II TT SC-PC-AL (aluminum)</b>	Table top unit with 4 duplexes (8 power), 72" cord with molded plug and 15 amp circuit breaker. Up to 8 configurable telecom. Black textured finish standard. UL Listed and CSA Certified  (S) silver pearl powder coat finish (AL) brushed and anodized aluminum finish  <i>CALL CUSTOMER SERVICE FOR PRICING ON SPECIFIED TELECOM PLATES</i>	<b>1,437</b> <b>1,467</b> <b>3,060</b>	<b>1,437</b> <b>1,467</b> <b>3,060</b>
	<b>INTRFC I TT SC</b> <b>INTRFC I TT SC-S (silver)</b> <b>INTRFCII TT SC-AL (aluminum)</b>	Tabletop unit with 2 duplexes (4 power), 72" cord with molded plug and 15 Amp circuit breaker. Up to 4 configurable telecom plates. Black textured finish. UL Listed and CSA Certified. (S) Silver pearl powder coat finish (AL)Brushed and anodized aluminum finish  <i>CALL CUSTOMER SERVICE FOR PRICING ON SPECIFIED TELECOM PLATES</i>	<b>816</b> <b>844</b> <b>1,830</b>	<b>816</b> <b>844</b> <b>1,830</b>
	<b>INTERACT SC</b> <b>INTERACT SC-S (silver)</b> <b>INTERACT SC-AL (aluminum)</b>	Tabletop unit with 1 duplex (2 power), 72" cord with molded plug, 15 Amp circuit breaker and 3rd receptacle on bottom for convenience outlet. 1 configurable telecom plate. Black textured finish. UL Listed, CSA Certified.  (S) Silver pearl powder coat finish (AL)Brushed and anodized aluminum finish  <i>CALL CUSTOMER SERVICE FOR PRICING ON SPECIFIED TELECOM PLATES</i>	<b>415</b> <b>445</b> <b>907</b>	<b>415</b> <b>445</b> <b>907</b>

	model number	description	list \$ zone 1	list \$ zone 2
	<b>VILLA -S (single)</b>	Villa series is a daisy chainable solution set up for training environments. All single kits (for 36", 42", 48", 60") come with one-two power villa base, one flush lid grommet, two interconnecting cables and 4 cable clamps.  Double kits (for 72" and 84") come with two villa bases, two villa grommets, three interconnecting cables and 6 cable clamps. Build your own kits available. UL Listed -  <i>MUST BE HARD WIRED - CALL CUSTOMER SERVICE FOR INFORMATION ON CUSTOM KITS</i>	<b>492</b>	<b>492</b>
	<b>VILLA -D (double)</b>		<b>799</b>	<b>799</b>
	<b>TOPDOCK - _ - _</b>	4 station unit with 1 power, 1 mini-stereo, 1 rJ45 CAT 6 at each station and i-pod dock in center, includes PS6000 power strip glossy white finish	<b>3,188</b>	<b>3,188</b>
	<b>TOP NOTCH 2 B - _</b>	Flip top with 1 power and 1 RJ45 CAT 6 -black finish (S) Brushed stainless steel finish	<b>621</b>	<b>621</b>
	<b>TOP NOTCH 2B-S - _</b>		<b>827</b>	<b>827</b>
	<b>TOP NOTCH 2 P - _</b>	Flip top with 2 power -black finish (S) Brushed stainless steel finish	<b>554</b>	<b>554</b>
	<b>TOP NOTCH 2 P-S - _</b>		<b>738</b>	<b>738</b>
	<b>TOP NOTCH 2 U - _</b>	Flip top with 1 power and 1 USB -black finish (S) Brushed stainless steel finish	<b>677</b>	<b>677</b>
	<b>TOP NOTCH 2 U-S - _</b>		<b>861</b>	<b>861</b>

			list \$ zone 1	list \$ zone 2
	<b>CONCEPT SC SQ-B</b>	Square with 72" cord pop up unit. Includes 4 power receptacles and 2 telecom plate cutouts on 2 sides	<b>1,702</b>	<b>1,702</b>
	<b>CONCEPT SC SQ-SS</b>	Includes top and trim plate with wire management brush to trim the cutout (**THIS IS REQUIRED**) (B) Black (SS) Stainless Steel  Optional pan for concealing unit when not installed in a pedestal - \$160  <i>CALL CUSTOMER SERVICE FOR PRICING ON SPECIFIED TELECOM PLATES OR IF WOOD TOP IS DESIRED</i>  <i>THIS ITEM REQUIRES TWO TELECOM PLATES. REFER TO PAGE 384 AND 385 OF THIS PRICE LIST FOR YOUR CHOICES AND PRICES OF OPTIONAL TELECOM PLATES. ON YOUR PO, INCLUDE THESE TELECOM</i>	<b>2,219</b>	<b>2,219</b>
	<b>CONCEPT SC RD-B - _</b>	Round with 72" cord pop up unit. Includes 4 power receptacles and 2 telecom plate cutouts on 2 sides	<b>1,493</b>	<b>1,493</b>
	<b>CONCEPT SC RD-SS - _</b>	Includes top and trim plate with wire management brush to trim the cutout (**THIS IS REQUIRED**) (B) Black (SS) Stainless Steel  Optional pan for concealing unit when not installed in a pedestal \$160  <i>CALL CUSTOMER SERVICE FOR PRICING ON SPECIFIED TELECOM PLATES OR IF WOOD TOP IS DESIRED</i>  <i>THIS ITEM REQUIRES TWO TELECOM PLATES. REFER TO PAGE 384 AND 385 OF THIS PRICE LIST FOR YOUR CHOICES AND PRICES OF OPTIONAL TELECOM PLATES. ON YOUR PO, INCLUDE THESE TELECOM PLATE ITEM NUMBERS AND PRICES ALONG WITH YOUR PLATE MODEL</i>	<b>2,077</b>	<b>2,077</b>
	<b>UDT SERIES SIDE-2</b>	2 POWER SIDE MOUNT	<b>391</b>	<b>391</b>
	<b>UDT SERIES SIDE-3</b>	3 POWER SIDE MOUNT  <i>CALL CUSTOMER SERVICE FOR PRICING ON SPECIFIED TELECOM PLATES</i>	<b>400</b>	<b>400</b>
	<b>UDT SERIES TOP-2 - _</b>	2 POWER TOP MOUNT	<b>391</b>	<b>391</b>
	<b>UDT SERIES TOP -3 - _</b>	3 POWER TOP MOUNT  <i>CALL CUSTOMER SERVICE FOR PRICING ON SPECIFIED TELECOM PLATES.</i>	<b>400</b>	<b>400</b>

	telecom plate	description	
	<b>A-BL-A-B</b> (black) <b>A-GR-A-B</b> (grey)	Telecom Plate with RJ11 Cat3 Phone and RJ45 Cat6 Data	\$143 (black plate) \$158 (grey plate)
	<b>A-BL-B-B</b> (black) <b>A-GR-B-B</b> (grey)	Telecom Plate with two RJ45 Cat6 Data	\$189 (black plate) \$203 (grey plate)
	<b>A-BL-B-B-B-B</b> (black) <b>A-GR-B-B-B-B</b> (grey)	Telecom Plate with four RJ45 Cat6 Data	\$367 (black plate) \$381 (grey plate)
	<b>A-BL-CRMINDER</b> (black) <b>A-GR-CRMINDER</b> (grey)	Telecom Plate with three cord bushings	\$55 (black plate) \$68 (grey plate)
	<b>A-BL-B-B-B</b> (black) <b>A-GR-B-B-B</b> (grey)	Telecom Plate with three RJ45 Cat6 Data	\$277 (black plate) \$292 (grey plate)
	<b>A-BL-B-L-37</b> (black) <b>A-GR-B-L-37</b> (grey)	Telecom Plate with RJ45 Cat6 Data, Mini Stereo Inline, and 15 Pin HD VGA F/F	\$313 (black plate) \$326 (grey plate)
	<b>A-BL-B-B-37</b> (black) <b>A-GR-B-B-37</b> (grey)	Telecom Plate with two RJ45 Cat6 Data, and 15 Pin HD VGA F/F	\$343 (black plate) \$356 (grey plate)
	(black)(grey)	Telecom Plate with DVI F/F	\$303 (black plate) \$317 (grey plate)
	<b>A-BL-C17-L-37</b> (black) <b>A-GR-C17-L-37</b>	Telecom Plate with one HDMI F/F, one Mini Stereo Inline and one 15 Pin HD VGA F/F	\$420 (black plate) \$431 (grey plate)

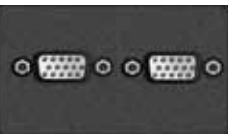
accessories

	telecom plate	description	list \$
	<b>A-BL-C9</b> (black) <b>A-GR-C9</b> (grey)	Telecom Plate with USB Inline	\$80 (black plate) \$95 (grey plate)
	<b>A-BL-C9-37</b> (black) <b>A-GR-C9-37</b> (grey)	Telecom Plate with USB Inline and 15 Pin HD VGA F/F	\$234 (black plate) \$248 (grey plate)
	<b>A-BL-C9-37</b> (black) <b>A-GR-C9-37</b> (grey)	Telecom Plate with USB Inline and 15 Pin HD VGA F/F	\$234 (black plate) \$248 (grey plate)
	<b>A-BL-77-78-79</b> (black) <b>A-GR-77-78-79</b> (grey)	Telecom Plate with three RCA - 1 Red, 1 White and 1 Yellow	\$123 (black plate) \$138 (grey plate)
	<b>A-BL-C17</b> (black) <b>A-GR-C17</b> (grey)	Telecom Plate with one HDMI F/F	\$204 (black plate) \$217 (grey plate)
	<b>A-BL-37-37</b> (black) <b>A-GR-37-37</b> (grey)	Telecom Plate with two 15 Pin HD VGA F/F	\$317 (black plate) \$333 (grey plate)
	<b>A-BL-C9-37-L</b> (black) <b>A-GR-C9-37-L</b> (grey)	Telecom Plate with USB Inline, 15 Pin HD VGA F/F and Mini Stereo Inline	\$294 (black plate) \$309 (grey plate)