

educational products

vol XII-I



www.moorecoinc.com



mooreco™



Best-Rite™







Balt® & Best-Rite® are brand divisions of MooreCo, Inc.

The Balt® & Best-Rite® Difference















Each product symbol represents a singular quality of the Balt® and Best-Rite® educational products offered at MooreCo. These qualities demonstrate the superiority and commitment of our brands. When you see these symbols, refer back to this page to learn what sets our product apart from the rest.

Visit www.moorecoinc.com for the full line of Balt® & Best-Rite® products.

Best-Rite® Visual Communication Products (pp. 18-89)

 In Stock - ships within 48 hours	 Quick Ship - ships within 7 days	 Warranty - call for details	 Eco-friendly product	 Magnetic surface	 Chemical-resistant surface
 Antimicrobial qualities	 Available with a fire-rated surface	 Includes free package of markers	 Surface is ideal for projection	 Interactive surface	 Customizable product
 Folds for easy storage	 Height adjustable for comfort	 Product made in the USA	 TAA compliant product		

Balt® Office Products (pp. 90-175)

 In Stock - ships within 48 hours	 Warranty - call for details	 No assembly required	 Assembles in less than 5 minutes	 Assembles in less than 15 minutes	 Ergonomic features
 Wheelchair friendly	 Antimicrobial qualities	 Heavy duty product	 Folds for easy storage	 Height adjustable for comfort	 Uses electrical assembly
 Integrated cable management	 TAA compliant product				



Return Policy: A return authorization is required for the return of any merchandise. All requests for returns should be made within 90 days of receipt of merchandise.

Restocking Fee: Returned merchandise will be subject to a restocking fee.

Non-Returnable Merchandise: Combination boards, horizontal sliding boards, and all boards which have been custom sized, custom framed, or customized to specifications will be considered a non-returnable item.

Table of Contents

What's New	4-9	Utility Carts	113-115
Custom Furniture Guide	10-11	Lecterns	116-120
Custom Room Solutions	12-17	Computer Security/Charging Carts	121
Markerboards		Training Tables	122-138
Interactive Markerboards	18-19	Workstations	
Aluminized Steel Markerboards	20-21	Instructor	139-140
Evolution Markerboards	22-23	Student	141
Porcelain Steel Markerboards	24-27	Carrels	142-149
Graphic Surface Markerboards	28	Seating	
Dura-Rite® Markerboards	29	Student	150-155
Magne-Rite Markerboards	30	Instructor	156-157
Tuf-Rite™ Markerboards	31	Storage & Organization	158
Markerboard Accessories	32-34	Accessories	159
Chalkboards	35	Early Childhood	
Tackboards		Furniture	160-161
Natural Cork Tackboards	36-38	Storage & Organization	162-165
Splash-Cork Tackboards	39	Room Dividers & Display Panels	166
Colored Cork Tackboards	40	Easels	167-172
Vinyl Tackboards	40-42	Language Arts	173-175
Rubber Tackboards	43	Administration	
Fabric Tackboards	44	Markerboards	177-182
Combination Boards	45-46	Accessory Boards	183
Architectural Boards	47-48	Tackboards	184-188
Resurfacing		Conference Room Boards	189-190
Markerboard Resurfacing	49-51	Conference Room Cabinets	191
Tackboard Resurfacing	52	Conference Room Tables	192-197
Easels	53-59	Conference Room Seating	198
Reversible Boards	59-65	Executive Seating	199-201
Room Dividers	66-71	Big & Tall Seating	202
Display Panels	72-76	Managerial Seating	202-203
Display Rails	77-78	Task Seating	203
Cases & Cabinets		Workstations	204-208
Bulletin Board Cabinets	79-83	Laptop Stands/Tables	209-210
Directory Board Cabinets	84-86	Printer/Equipment Stands	211-213
Signs	86-87	Desk Accessories	214-216
Display Cases	88-89	Ecological Certifications	217
Audio/Visual		Surface Comparisons	218
Interactive Whiteboard Stands	90-95	Trims & Surfaces	219-220
Flat Panel Stands	96-101	Index	221-223
Projection Carts	102-112		



© 2012 MooreCo, Inc. All rights reserved.

MooreCo, Inc. reserves the right to correct pricing or copy errors. Due to the current volatility in the price of raw and finished materials, please refer to our latest price list for pricing. Since individual items are subject to availability of materials from our suppliers, we reserve the right to limit quantities. All shipping weights are nominal and may vary depending on items and quantities ordered.

What's



@



Balt® Products

Height Adjustable Flipper Table

It raises. It nests. There's not a whole lot this table can't do. See p. 122-123.

Shown in Nepal Teak



Elevation™ Mobile Stand shown with OneBoard™ Interactive Whiteboard.



Circulation Task Chairs, p. 156.

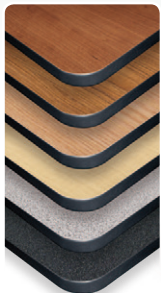

Available with custom color tops! Find out more at moorecoinc.com/custom



iTeach™ 2 Mobile Interactive Whiteboard Stand

We did it again. Find out about the second generation of iTeach™ and how we made it even better. See p. 90-91.

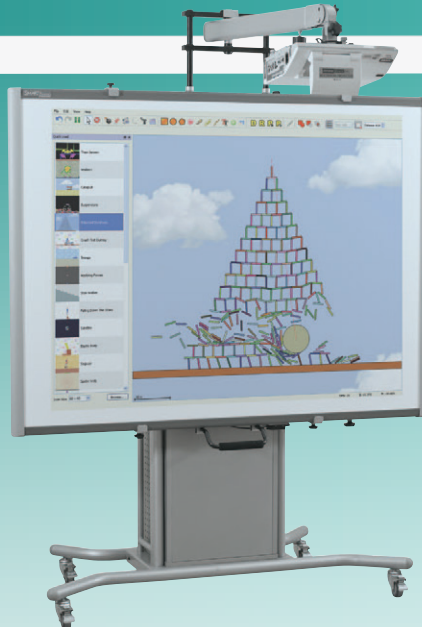

Elevation™ Wall Mount and Elevation™ Mobile Stands

Use Elevation™ Wall Mount to adjust your classroom IWB or use Elevation™ Mobile Stand to make your Elevation™ Wall Mount mobile. The Elevation™ Mobile Stand is also available as a flat panel stand! See pages 93-96.



Optima LM Document Camera Cart



Optima EM Document Camera Cart

Optima Document Camera Carts

Explore this document camera cart's customizable options. See p. 102-103.

Beta Sit-Stand Workstation

Get up, stand up, stand up for your right... to work! See p. 204.



What's



@



Balt® Products

Instructor Teacher's Desk

Angled for comfort and function, this desk has everything an instructor needs in a workstation. See p. 139. Custom color tops also available. See p. 10-11 or moorecoinc.com/custom



Mentor Seminar Table

Clean lines, sufficient table space, all at an economical price! See p. 134.



Chi Flipper Seminar Table

A classy looking seminar table that can flip for easy storage. See p. 132.



iFlex™ Seminar Table

A simple, nimble table for a seminar space. See p. 133.



Odyssey Charging Cart

Security and mobility for up to 24 laptop computers or tablets. See p. 121.



Alpha Cart

For those who need a mobile, compact, adjustable height presentation cart or workstation. See p. 107.



Nesting Stacking Tablet Chair

Finally! A tablet chair with plenty of elbow room. See p. 150.



Stacking Stool

Perfect for labs and other elevated work areas. See p. 157.



Renew Stack Chair

Light, sturdy, and also made with recycled materials. See p. 152.



Step Stool

Put those hard-to-reach classroom items within your reach. See p. 158.



Oui Guest Chair

Clean elegant lines with a sturdy frame. See p. 151.



What's



@



Best-Rite® Products



Visionary™ Magnetic Glass Markerboard

Sleek, magnetic and always erasable glass board. See p. 178.



Elemental™ Frameless Dry Erase & Projection Surface

Just unroll, peel, and stick. Instant magnetic markerboard. Also ships UPS! See p. 20-21.



Sharewall™ Frameless Dry Erase & Projection Surface

Transform entire walls into markerboards with floor-to-ceiling coverage! See p. 51.



Virtually seamless installation on large or curved walls.

Weather Sentinel Outdoor Bulletin Board Cabinets

Our newest series of outdoor bulletin board cabinets. See p. 81.



All-Weather Herald Outdoor Bulletin Board Cabinets

Our first self-standing outdoor bulletin board cabinets. See p. 83.

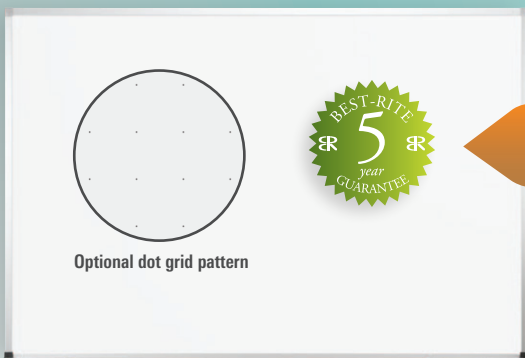

Optional dot grid pattern



TuF-Rite™ Markerboard

Our newest economy grade markerboard surface. See p. 31.

Look for these other fresh items in the Best-Rite® line-up...

Tack Bite, p. 77.



Navigator Floor Sign Stand, p. 87.



Quest Star-Based Easel, p. 53.



Trek Mobile Room Divider, p. 68.



Custom Furniture Guide



For the first time ever, MooreCo has teamed with Wilsonart International to now offer an array of custom color options for our Lumina™, Brawny, and Height Adjustable Flipper tables.

Choose from four different frame options and combine with various color surfaces and edgebands to form hundreds of possible combinations. Build your ideal table today! Call 800-749-2258 for all pricing information.

Design your own table: *It's great to have options!*

Step 1 Choose ANY Wilsonart® color!



Explore all Wilsonart® color choices. Visit www.wilsonart.com.

Just visit the Wilsonart International website and explore the full spectrum of high pressure laminate options. Once you find your desired surface, call us at 800-749-2258, and we will work with you to create and price your ideal custom table!

Step 2 Choose Edgeband Color.

- Dove Grey
- Slate Grey
- Chocolate Brown
- Black
- Tough-Edge™ Rubberized Black
- Matching Color Edgeband
(Call for details on availability)
- Custom Color Edgeband
(Call for details)

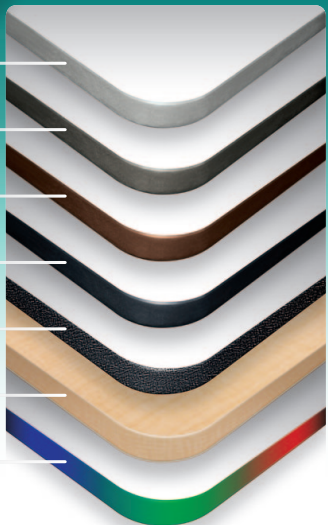

Step 3 Choose Table Frame.

- A** Black Lumina™ folds into space-saving nesting position.
- B** Platinum Lumina™ folds into space-saving nesting position.
- C** Brawny Black frame allows for 8" of height adjustment.
- D** Height Adjustable Flipper Black frame folds into nesting position and also allows for 8 1/2" of height adjustment.



Qs

These surface colors are available in Quick Ship!

Edge band color will match the designated color of the table frame.

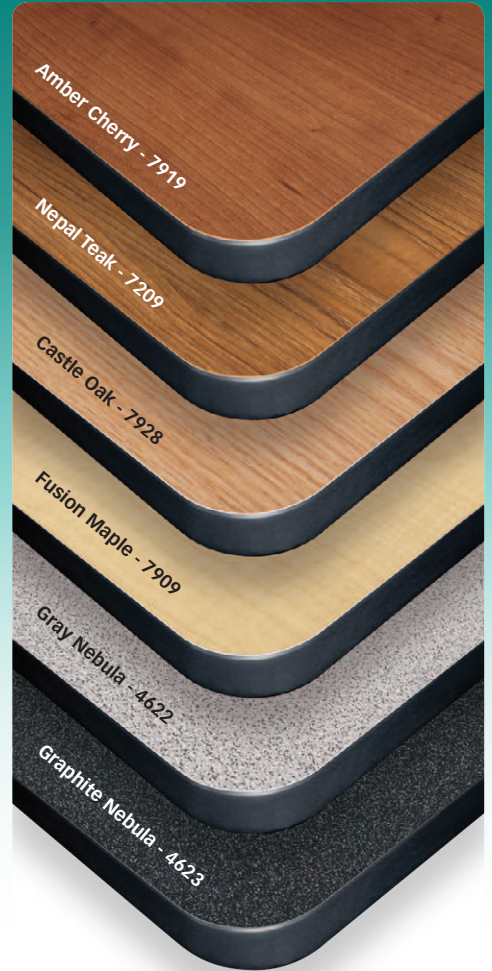

Go Wild

With endless combinations!



Brawny Black frames allow for 8" height adjustment.

C



Fusion Maple table top with Black Lumina™ frame and black edgeband.

A



Gray Nebula table top with Platinum Lumina™ gray frame and red edgeband.

B



Nepal Teak table top with Brawny Black frame and Nepal Teak edgeband.



Lumina™ frames fold into a nesting position for space-saving storage.

Build yours today!

* Quick Ship tables available with black or gray edgeband only.



24 1/4" to 32 3/4"



D

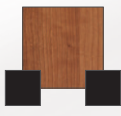

Amber Cherry table top with Height Adjustable Flipper Black frame and black edgeband.



Height Adjustable Flipper Black frames allow for 8 1/2" height adjustment and also fold into a nesting position for space-saving storage.

Build your own custom table today!
Go to www.moorecoinc.com/custom or call 800-749-2258 to get started!



 Black Cherry Lumina™ woodgrain vacuum-formed PVC with black frame

Create a custom designer environment with the Black Cherry Lumina™ series of training and conference room furnishings.



Please refer to p. 2 for a description of symbols.

Black Cherry Lumina™ Series

- » Create multipurpose work areas with Black Cherry Lumina™ Folding Tables. Tops are finished in cherry woodgrain laminate. Tops flip and tables nest for storage. Powder-coated steel frame with 3" casters (two locking). Custom tops and bases available! Call for details or visit www.moorecoinc.com/custom
- » Black Lumina™ Room Dividers separate any area with style and functionality. Double sided magnetic dry erase markerboard surfaces with black aluminum trim. Each divider comes with 3" casters (two locking).
- » Mount up to a 42" display on the Black Cherry Lumina™ Flat Panel Stand. Bracket is angle adjustable and height adjustable. Cherry woodgrain laminate AV shelf. Includes 3" casters (two locking).
- » Mobile Black Lumina™ Reversible Boards feature a surface that rotates 360° to provide twice the functional space of a traditional board. Black powder-coated steel frame with 3" casters (two locking).
- » Black Cherry Lumina™ Podium features a cherry woodgrain laminate top. Open front storage area. Black powder-coated steel base includes 3" locking casters.

Tables shown with Circulation Chairs, see p. 156.

Nesting position allows for space-saving storage!



The Black Cherry Lumina™ woodgrain finish is vacuum-formed PVC.

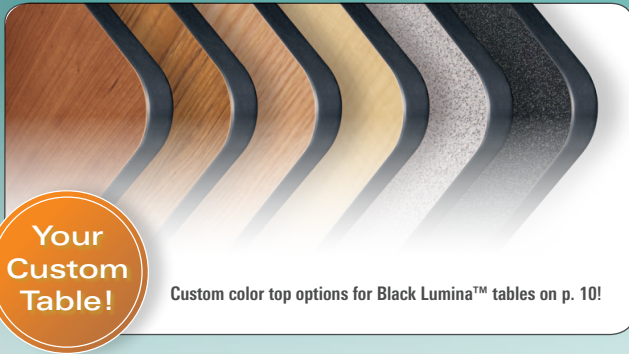

Your Custom Table!

Custom color top options for Black Lumina™ tables on p. 10!



Half-round tables also available.

A Black Cherry Lumina™ Folding Tables				
Part No.	Item	Dimensions	Ship Wt.	Price
90064	6024 Table	29 1/2"H x 60"W x 24"D	81 lbs	\$502.95
90067	7224 Table	29 1/2"H x 72"W x 24"D	113 lbs	\$565.95
89999**	1/2 Rnd Table	29 1/2"H x 48"W x 24"D	53 lbs	\$397.95

B Black Cherry Lumina™ Flat Panel Stand			
Part No.	Dimensions	Ship Wt.	Price
27579	62 3/4"- 80 1/4"H x 25"W x 27 3/4"D	75 lbs	\$570.00

C Black Cherry Lumina™ Podium			
Part No.	Dimensions	Ship Wt.	Price
27574*	44 3/4"H x 25"W x 24"D	36 lbs	\$379.00

D Black Lumina™ Room Divider			
Part No.	Dimensions	Ship Wt.	Price
27578	72"H x 39 1/2"W x 20"D	65 lbs	\$624.74

E Black Lumina™ Reversible Board			
Part No.	Dimensions	Ship Wt.	Price
62387**	40"H x 30"W (Board only)	65 lbs	\$655.79
62390	4'H x 5'W (Board only)	110 lbs	\$873.45



See more on the Black Lumina™ Reversible on p. 65.

See more on the Black Cherry Lumina™ Podium on p. 116.



See more on the Black Lumina™ Room Divider on p. 68.

See more on the Black Cherry Lumina™ Flat Panel Stand on p. 99.

Scan this QR code >
to watch our YouTube video!



Limited
Lifetime
Warranty!

Antimicrobial gray top with
platinum frame

Tables shown with
Circulation Chairs,
see p. 156.

Create a custom designer environment
with the Platinum Lumina™ series of
training and conference room furnishings.



Please refer to p. 2 for a description of symbols.



Find out more online!
youtube.com/moorecoinc

Platinum Lumina™ Series

- » Create multipurpose areas with Platinum Lumina™ Folding Tables. Tops are powder-coated antimicrobial MDF and will not delaminate. Tops flip and tables nest for storage. Powder-coated steel frame with 3" casters (two locking). Custom tops (non antimicrobial) and legs available! www.moorecoinc.com/custom
- » Platinum Lumina™ Room Dividers separate any area with style and functionality. Double sided magnetic dry erase markerboard surfaces. Each divider comes with 3" casters (two locking).
- » Mount up to a 42" display on the Platinum Lumina™ Flat Panel Stand. Bracket is angle adjustable and height adjustable. Powder-coated MDF shelf will not delaminate. Includes 3" casters (two locking).
- » Mobile Platinum Lumina™ Reversible Boards feature a surface that rotates 360° to provide twice the functional space of a traditional board. Silver powder-coated steel frame with 3" casters (two locking).
- » Platinum Lumina™ Podium features a powder-coated MDF top that will not delaminate. Open front storage area. Powder-coated steel base includes 3" locking casters.

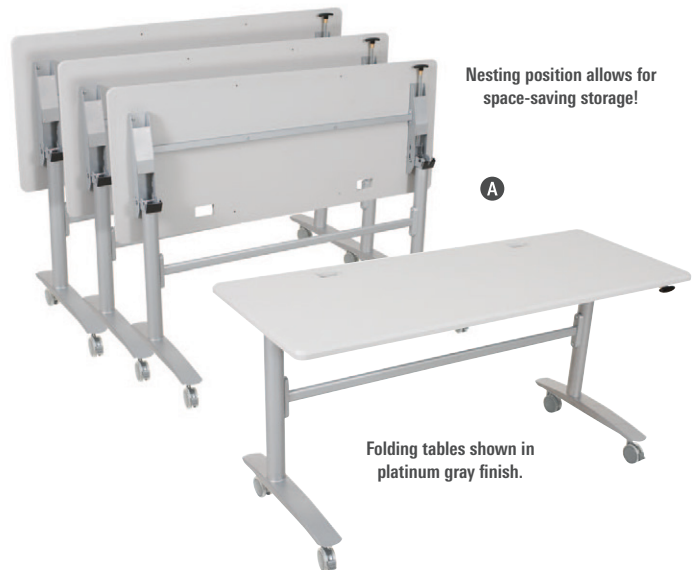

Nesting position allows for
space-saving storage!

Folding tables shown in
platinum gray finish.



Your Custom Table!

Custom color top options for Platinum Lumina™ tables on p. 10!



Gray powder-coated MDF tops are antimicrobial.



Table tops flip back with a simple-to-use one handed lever mechanism.



Half-round tables also available.



See more on the Lumina™ Reversible on p. 65.

See more on the Lumina™ Podium on p. 116.



See more on the Lumina™ Room Divider on p. 68.

See more on the Lumina™ Flat Panel Stand on p. 99.

A Platinum Lumina™ Folding Tables

Part No.	Item	Dimensions	Ship Wt.	Price
89954	6024 Table	29 1/2"H x 60"W x 24"D	81 lbs	\$576.45
89955	7224 Table	29 1/2"H x 72"W x 24"D	113 lbs	\$628.95
89956	1/2 Rnd Table	29 1/2"H x 48"W x 24"D	53 lbs	\$423.15

B Platinum Lumina™ Flat Panel Stand

Part No.	Dimensions	Ship Wt.	Price
27561	62 3/4" - 80 1/4"H x 25"W x 27 3/4"D	75 lbs	\$570.00

C Platinum Lumina™ Podium

Part No.	Dimensions	Ship Wt.	Price
27562*	44 3/4"H x 25"W x 24"D	36 lbs	\$379.00

D Platinum Lumina™ Room Divider

Part No.	Dimensions	Ship Wt.	Price
74861	72"H x 39 1/2"W x 20"D	65 lbs	\$589.84

E Platinum Lumina™ Reversible Board

Part No.	Dimensions	Ship Wt.	Price
62382**	40"H x 30"W (Board only)	65 lbs	\$529.65
62383	4'H x 5'W (Board only)	110 lbs	\$743.65

Custom Room Solutions: Flipper Training Tables



Teak



Mahogany



Please refer to p. 2 for a description of symbols.

Tables flip and nest for easy storage!



Flipper Training Tables

- » Easily create a multipurpose work area with versatile Flipper Conference and Training Tables.
- » GREENGUARD Indoor Air Quality Certified® and GREENGUARD Children & Schools CertifiedSM.
- » Tops are vacuum-formed PVC available with a teak or mahogany wood grain finish.
- » Flip top back with a simple lever mechanism and nest together space-saving storage.
- » Frame is black powder-coated steel and includes a perforated steel modesty panel.
- » Each table rolls easily out of the way on 2" casters (two locking).
- » TAA compliant. 10 year guarantee. Tested to support up to 300 lbs.

A Flipper Table - 36x24				
Part No.	Color	Dimensions	Ship Wt.	Price
89870*	Teak	29 1/2"H x 36"W x 24"D	56 lbs	\$369.63
89876*	Mahogany	29 1/2"H x 36"W x 24"D	56 lbs	\$369.63
B Flipper Table - 60x24				
Part No.	Color	Dimensions	Ship Wt.	Price
89775	Teak	29 1/2"H x 60"W x 24"D	86 lbs	\$597.70
89879	Mahogany	29 1/2"H x 60"W x 24"D	86 lbs	\$597.70
C Flipper Table - 72x24				
Part No.	Color	Dimensions	Ship Wt.	Price
89863	Teak	29 1/2"H x 72"W x 24"D	118 lbs	\$633.65
89880	Mahogany	29 1/2"H x 72"W x 24"D	118 lbs	\$633.65
D Flipper Table - Half Round				
Part No.	Color	Dimensions	Ship Wt.	Price
89773**	Teak	29 1/2"H x 48"W x 24"D	58 lbs	\$448.28
89877**	Mahogany	29 1/2"H x 48"W x 24"D	58 lbs	\$448.28



Green-Rite® eco-friendly markerboard available on p. 24.



Platinum Reversible Board available on pp. 62-63.



Presentation Cart available on p. 104.

Circulation chairs available on p. 156.



Flipper tables are ideal for training rooms or conference rooms.

Now supports dual users with multi-touch!

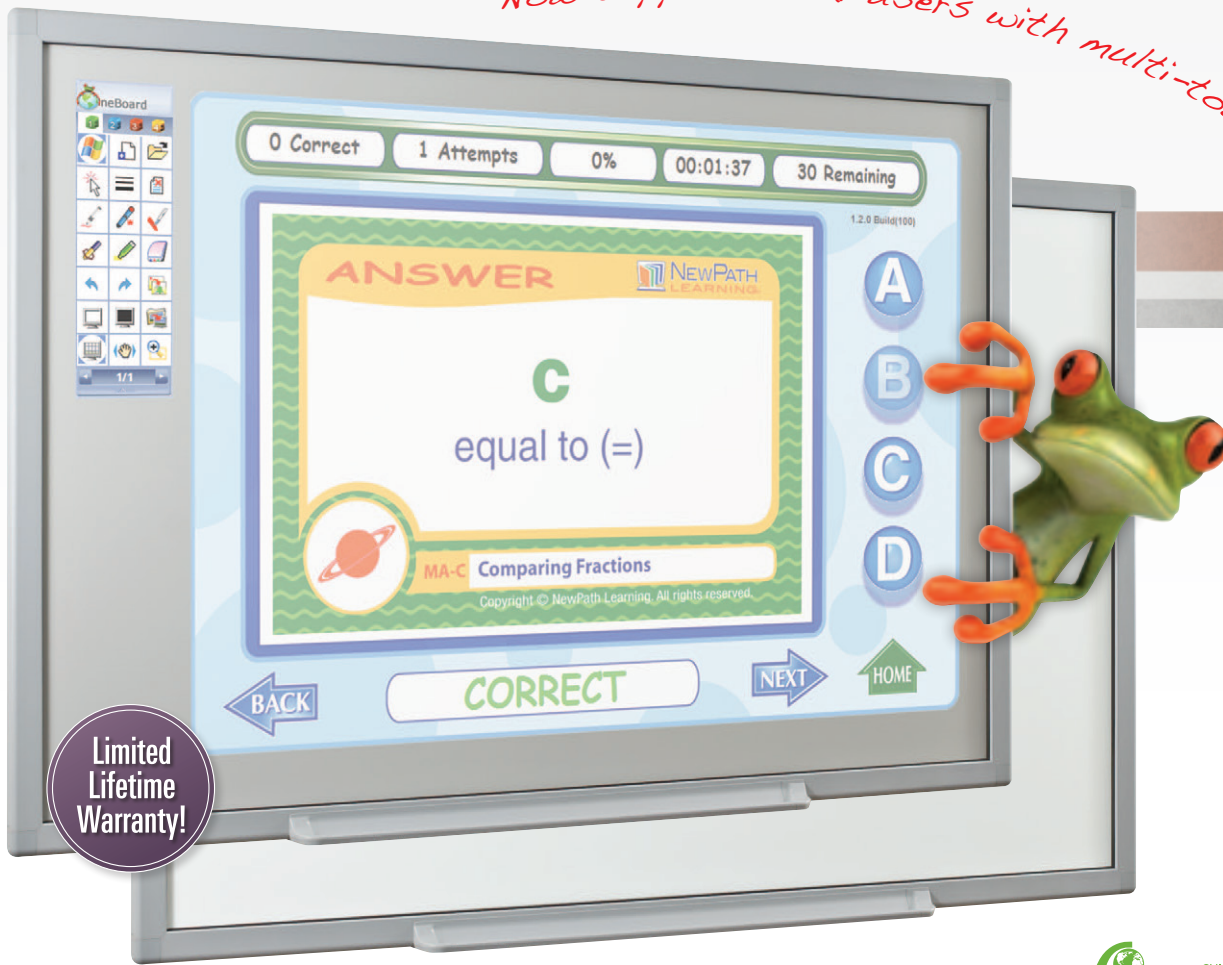

Limited Lifetime Warranty!



Please refer to p. 2 for a description of symbols.



OneBoard™

- » Your OneBoard™ for interactivity, dry erase, projection, and magnetic displays that will last a **LIFETIME**.
- » Combine the utility of a porcelain surface whiteboard with the power of a computer and digital projector for a full interactive experience with vivid images, video and audio.
- » The combination of mouse and keyboard emulation allows you to control the computer almost exclusively from the OneBoard™. Software enables the board to act as a human input device (HID). Write, draw, and move objects with just your finger!
- » True multiuser support requires no separate multiuser mode setting to instantly make your lecture more interactive. Supports multiuser writing and common multi-touch gestures currently recognized in Microsoft Windows 7.
- » Open architecture. No requirement to tie yourself to a particular software platform.
- » Optional USB wireless PC adapter available to enable wireless interaction.
- » Porcelain steel can be written on with dry erase, semi-permanent, water-soluble, or permanent markers, pens, or crayons without damaging the surface. Use a dry cloth, eraser, or cleaner to easily remove writing. Also available in matte projection gray surface, cutting glare up to 60%. Gray surface requires a wet cloth to completely clean surface (a small amount of ghosting may occur).
- » RoHS compliant. TAA compliant. GREENGUARD Indoor Air Quality Certified® and GREENGUARD Children & Schools CertifiedSM. Limited lifetime warranty.





Find out more online!
youtube.com/moorecoinc

Visit us online for current
 OneBoard™ news
www.moorecoinc.com/oneboard

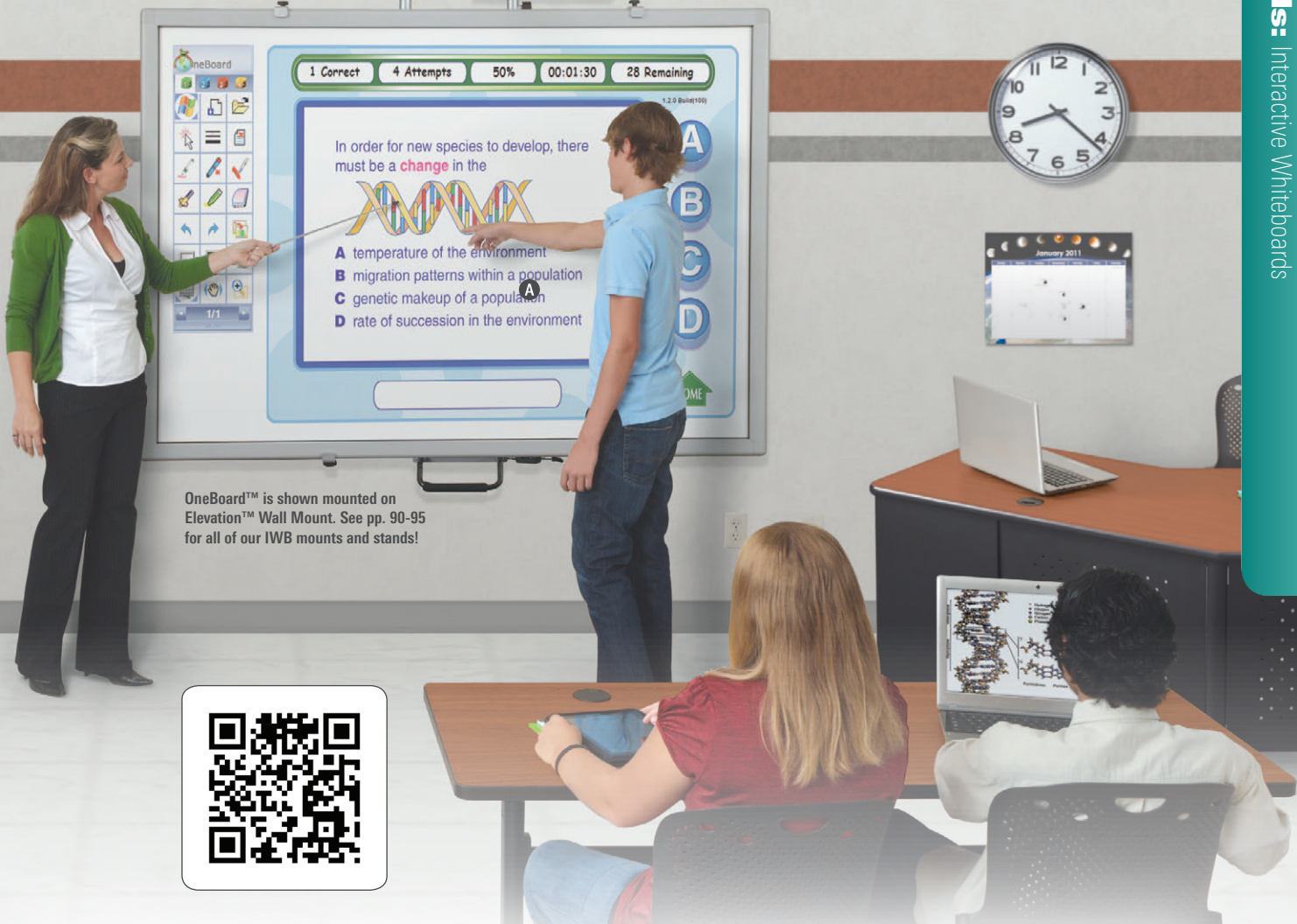

OneBoard™ is shown mounted on
 Elevation™ Wall Mount. See pp. 90-95
 for all of our IWB mounts and stands!



Technical Specifications	
Item	Specification
Tracking Technology	LED Touch Technology
Mouse Feature	Yes
Touch Sensitive	Yes
Intelligent Feature Touch	Yes
Resolution	12800 x 9600
Bundled Software	Interactive Digital Board Software
Computer Interface	USB 2.0
Operating System	Windows 98, ME, 2000, XP, Vista, Windows 7
CPU	P4 1.7GHz or higher
Hard Drive Space	500 MB
2.4g Wireless Maximum	<0 dBm
Sampling Rate	Up to 120 points/sec
Power Consumption	<250 mA USB powered
Ambient Temperature	14°F to 104°F
Humidity	30-90%

Physical Specifications	
Item	Specification
Digital Board Dimensions	48"H x 67 ½"W x 1 ¼"D (77" diagonal)
Effective Touch Screen Size	44 ¾"H x 64 ¼"H
Weight	79 lbs
Shipping Dimensions	55"H x 73"W x 6"D
Shipping Weight	115 lbs

A OneBoard™ - Porcelain Steel			
Part No.	Dimensions	Weight	Price
■ 9037G	48"H x 67 ½"W x 1 ¼"D	115 lbs	Call
B OneBoard™ - Projection Plus®			
Part No.	Dimensions	Weight	Price
■ 9057G	48"H x 67 ½"W x 1 ¼"D	115 lbs	Call



A
Glossy
Off-White



B
Matte
Gray



Please refer to p. 2 for a description of symbols.



Ships UPS to save
you time and money!

Elemental™ Frameless Markerboard with new Evolution Surface

- » Think outside the frame with Elemental™, the surface that does it all!
- » Mounting securely as a frameless, minimalist whiteboard available in a variety of surfaces, Elemental™ is ideal for cubicles, offices, and other personal workspaces. Rounded corner radius adds style and eliminates sharp corners.
- » Made from porcelain coated steel alloy, Elemental™ is engineered with a high aluminum content for flexibility, making it ideal for curved walls or installation on pillars.
- » When unrolled, the lightweight surface lays flat and stays flat, and features a self adhesive backing for easy installation.
- » Available in glossy off-white or Evolution Projection matte gray surface for enhanced projection clarity while minimizing glare. Please specify surface when ordering.
- » Elemental™ ships rolled, and sizes up to 4'H x 8'W will ship UPS to save you money.
- » 50 year guarantee. TAA compliant.

● Elemental™ with Glossy Off-White Surface

Part No.	Dimensions	Ship Wt.	Price
208JA-25*	1 ½'H x 2'W	6 lbs	\$52.21
208JB-25*	2'H x 3'W	11 lbs	\$105.42
208JC-25*	3'H x 4'W	21 lbs	\$228.72
208JD-25*	4'H x 4'W	28 lbs	\$291.10
208JG-25*	4'H x 6'W	42 lbs	\$415.85
208JH-25*	4'H x 8'W	56 lbs	\$540.61

● Elemental™ with Evolution Surface - Matte Gray

Part No.	Dimensions	Ship Wt.	Price
408JA-52*	1 ½'H x 2'W	6 lbs	\$59.04
408JB-52*	2'H x 3'W	11 lbs	\$118.07
408JC-52*	3'H x 4'W	21 lbs	\$256.17
408JD-52*	4'H x 4'W	28 lbs	\$326.03
408JG-52*	4'H x 6'W	42 lbs	\$465.75
408JH-52*	4'H x 8'W	56 lbs	\$605.48

Low profile edges
make Elemental™ safe for kids!



Brite Kids early childhood furniture, see pages 160-161.



Step 3

Line up, stick in place, roll out any air pockets, and you're done!

Instant markerboard.

So EASY to install

Just follow these simple steps:



Step 1

Unpack roll from box.



Step 2

Peel away backing.

Leave all other boards in the dust

with the new Evolution surface by Best-Rite®. Project. Write. Dry erase. All on one surface. Evolution is a porcelain steel markerboard surface specially engineered for superior projection performance, providing a sharp, clear image.

Browse our selection of products that feature the Evolution Surface.



Please refer to p. 2 for a description of symbols.

Evolution Markerboard with Deluxe Aluminum Trim

A
Deluxe Aluminum

- Evolution projection surface is a porcelain steel markerboard designed with the future in mind, providing an image that is rich and vivid when used with a projector.
- Low gloss surface provides exceptional sharpness and clarity, eliminating dullness caused by external light sources. Available in matte gray.
- Deluxe Aluminum Trim includes full-length enclosed maprail and full-length accessory tray with rubber Dura-Safe® end caps.
- For best results, wet erase gray surface weekly.
- Rite-On® dry erase markers by Best-Rite® recommended. Pair with one of our marker sets.
- Made in the USA. 50 year guarantee. TAA compliant.



Evolution - Deluxe Aluminum Trim

Gray	Dimensions	Ship Wt.	Price
404AB-52*	2'H x 3'W	22 lbs	\$184.00
404AC-52**	3'H x 4'W	25 lbs	\$316.00
404AD-52	4'H x 4'W	69 lbs	\$389.00
404AG-52	4'H x 6'W	122 lbs	\$568.00
404AH-52	4'H x 8'W	145 lbs	\$750.00
404AK-52	4'H x 10'W	180 lbs	\$941.00
404AM-52	4'H x 12'W	222 lbs	\$1,125.00
404AP-52	4'H x 16'W	290 lbs	\$1,492.00

Evolution Markerboard with Presidential Trim

- Ensure your presentations make an impression with Evolution projection surface by Best-Rite®, a porcelain steel surface designed for premium projection performance, providing a sharp, crisp image like none other.
- Superior low gloss surface helps prevent distortion from external light sources and is available in matte gray.
- Featured in elegant and modern Presidential Trim in either silver or black. Matching Magnetic Q-Tray included.
- For best results, wet erase gray surface weekly.
- Rite-On® dry erase markers by Best-Rite® recommended. Pair with one of our marker sets.
- Made in the USA.
- 50 year guarantee.
- TAA compliant.

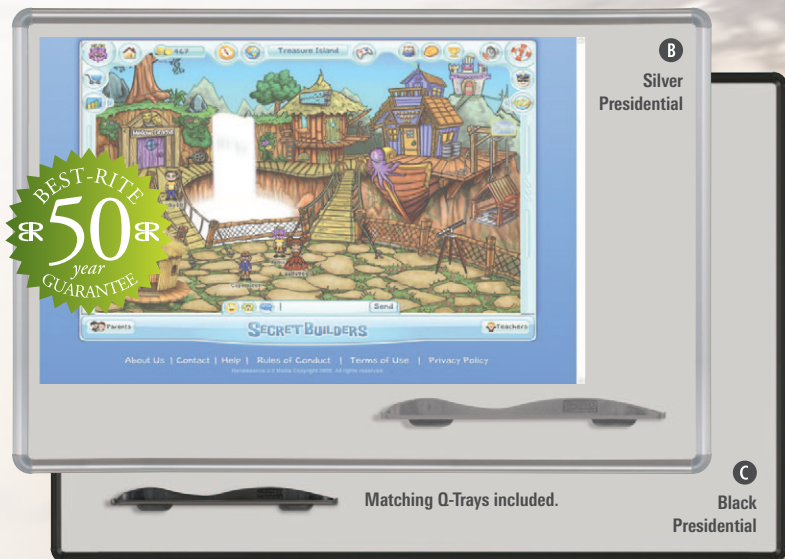

Evolution - Silver Presidential Trim

Gray	Dimensions	Ship Wt.	Price
404PA-52*	1 1/2'H x 2'W	12 lbs	\$130.00
404PB-52*	2'H x 3'W	22 lbs	\$195.00
404PC-52**	3'H x 4'W	25 lbs	\$338.00
404PD-52	4'H x 4'W	69 lbs	\$422.00
404PG-52	4'H x 6'W	122 lbs	\$614.00
404PH-52	4'H x 8'W	145 lbs	\$822.00

Evolution - Black Presidential Trim

Gray	Dimensions	Ship Wt.	Price
404PA-T1-52*	1 1/2'H x 2'W	12 lbs	\$130.00
404PB-T1-52*	2'H x 3'W	22 lbs	\$195.00
404PC-T1-52**	3'H x 4'W	25 lbs	\$338.00
404PD-T1-52	4'H x 4'W	69 lbs	\$422.00
404PG-T1-52	4'H x 6'W	122 lbs	\$614.00
404PH-T1-52	4'H x 8'W	145 lbs	\$822.00



Give your board new life and functionality with our Retro-Finish Panels!

A Matte Gray

Pre-drilled holes ensure easy installation on top of existing surface.

BEST-RITE
\$50
year GUARANTEE

Retro-Finish Panel with Evolution Surface

- » Easily upgrade your school or office with the new Retro-Finish Panel with Evolution projection surface. The Retro-Finish Panel makes short work of resurfacing any old chalkboard or markerboard.
- » No need to remove existing board. Simply screw Retro-Finish Panel into old board.
- » Factory framed panels come with pre-drilled holes to make mounting easy.
- » Available in matte gray. Custom sizes available.
- » For best results, wet erase grey surface weekly.
- » Rite-On® dry erase markers by Best-Rite® recommended. Pair with one of our marker sets.
- » Made in the USA. 50 year guarantee. TAA compliant.

A Retro-Finish Panel - Evolution Surface

Part No.	Color	Dimensions	Ship Wt.	Price
4R4A-52	Matte Gray	4' x 4', 6', 8', 10', or 12'	3 ½ lbs/sq ft	\$13.98/sq ft

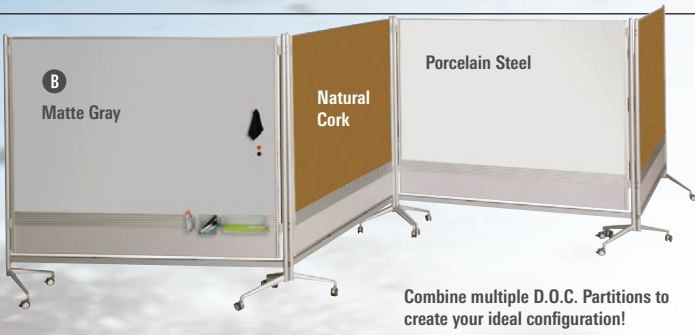

D.O.C. Partition with Evolution Surface

- » D.O.C. Partitions allow you to divide, organize, and customize a work or display area.
- » Evolution projection surface is a magnetic, low gloss, porcelain steel markerboard surface specially engineered for superior projection performance.
- » Slat panel along the bottom holds optional accessory trays.
- » TAA compliant.

C D.O.C. Partitions - Evolution Surface

Surface Combination	6'H x 4'W	Ship Wt.	Price	6'H x 6'W	Ship Wt.	Price	6'H x 8'W	Ship Wt.	Price
Matte Gray / Matte Gray	661AD-YY	130 lbs	\$982.28	661AG-YY	180 lbs	\$1,353.18	661AH-YY	220 lbs	\$1,575.45
Matte Gray / Porcelain Steel	661AD-DY	130 lbs	\$886.46	661AG-DY	180 lbs	\$1,221.17	661AH-DY	220 lbs	\$1,421.74
Matte Gray / Natural Cork	661AD-YC	130 lbs	\$820.39	661AG-YC	180 lbs	\$1,036.29	661AH-YC	220 lbs	\$1,304.95

Optional Accessory Trays

Part No.	Description	Ship Wt.	Price
661PT*	3 Tray Set	5 ½ lbs	\$28.74

Now available with 4' x 8' board!



Platinum Reversible Board with Evolution Surface

- » Platinum Reversible Boards provide twice the functional surface of a wall-mounted board.
- » Mobile boards are double-sided and available in a variety of surface combinations, now including Evolution projection surface by Best-Rite®.
- » Evolution projection surface is a magnetic, low gloss, porcelain steel markerboard surface specially engineered for superior projection performance.
- » Evolution surface available in matte gray.
- » Surface rotates 360° on a pivot hinge and locks into place with the turn of a knob.
- » Available in 40"H x 30"W or 4'H x 6'W with modern anodized aluminum trim. Wide base design for stability includes 3" locking casters.
- » TAA compliant.

C Platinum Reversible Boards - Evolution Surface

Surface Combination	40"H x 30"W	Ship Wt.	Price	4'H x 6'W	Ship Wt.	Price	4'H x 8'W	Ship Wt.	Price
Matte Gray / Matte Gray	669RU-YY**	72 lbs	\$890.00	669RG-YY	186 lbs	\$1,294.00	669RH-YY	211 lbs	\$1,488.00
Matte Gray / Porcelain Steel	669RU-DY**	72 lbs	\$845.00	669RG-DY	186 lbs	\$1,180.00	669RH-DY	211 lbs	\$1,385.00
Matte Gray / Natural Cork	669RU-YC**	68 lbs	\$804.00	669RG-YC	166 lbs	\$1,100.00	669RH-YC	191 lbs	\$1,300.00

■ In Stock: ships within 48 hours of order. ■ Quick Ship: ships within 7 days of order.
*Ships UPS. **Ships UPS + \$9.00 handling fee.

A

Green-Rite® board features 100% natural cork insert in the full-length enclosed map rail.







See product video online!
youtube.com/moorecoinc

Class A Fire Rated Board!

Environmentally friendly porcelain steel board is up to 98% recyclable!

Dura-Safe® end caps eliminate sharp edges and corners.





What is Cradle to Cradle® Certification?

Cradle to Cradle® Certification is awarded to products that pursue an innovative vision of ecologically-intelligent design that eliminates the concept of waste. This means using environmentally safe and healthy materials, designing for material reutilization, such as recycling and composting, and the use of renewable energy or energy efficiency. Products are produced through sustainable environmentally and socially responsible business practices and are made under strict quality assurance specifications.



Please refer to p. 2 for a description of symbols.

Green-Rite® Markerboard with Deluxe Aluminum Trim

- » Green-Rite® eco-friendly porcelain steel surface is featured with aluminum trim.
- » Cradle to Cradle Certified™ - Silver, GREENGUARD Indoor Air Quality Certified® and GREENGUARD Children & Schools Certified™.
- » Certified boards incorporate material healthfulness, material reutilization, renewable energy use, water stewardship and social responsibility.
- » Board is 98% recyclable, contains up to 22% recycled materials, and emits virtually no VOCs.
- » Class A Fire Rated board. A full test report copy is available upon request.
- » Includes full-length accessory tray with Dura-Safe® end caps and a full-length map rail with natural cork insert.
- » Made in the USA. 50 year guarantee. GSA/TAA compliant.

Green-Rite® Markerboard - Deluxe Aluminum Trim

Part No.	H x W	Ship Wt.	Price
E2H2AB*	2'H x 3'W	22 lbs	\$131.58
E2H2AC**	33 3/4"H x 4'W	25 lbs	\$244.21
E2H2AD	4'H x 4'W	69 lbs	\$291.19
E2H2AG	4'H x 6'W	122 lbs	\$425.97
E2H2AH	4'H x 8'W	145 lbs	\$562.15



Scan this QR code to watch our Green-Rite® Markerboard online video.



Please refer to p. 2 for a description of symbols.

Green-Rite® Markerboard with Aluminum Trim

- » Green-Rite® eco-friendly porcelain steel surface is featured with aluminum trim.
- » Cradle to Cradle Certified™ - Silver, GREENGUARD Indoor Air Quality Certified® and GREENGUARD Children & Schools Certified™.
- » Cradle to Cradle Certified™ boards incorporate material healthfulness, material reutilization, renewable energy use, water stewardship and social responsibility.
- » The board is 98% recyclable, contains up to 22% recycled materials, and emits virtually no VOCs.
- » Class A Fire Rated board. A full test report copy is available upon request.
- » Includes full-length accessory tray with Dura-Safe® end caps.
- » Made in the USA. 50 year guarantee. TAA compliant.



Cleaner & Accessories pp. 32-33.



Class A Fire Rated Board!

Environmentally friendly porcelain steel board is up to 98% recyclable!

Green-Rite® Markerboard - Aluminum Trim

Part No.	H x W	Ship Wt.	Price
E2H2AB-NM*	2'H x 3'W	22 lbs	\$139.92
E2H2AC-NM**	3'H x 4'W	25 lbs	\$258.64
E2H2AD-NM	4'H x 4'W	69 lbs	\$308.46
E2H2AG-NM	4'H x 6'W	122 lbs	\$451.56
E2H2AH-NM	4'H x 8'W	145 lbs	\$595.72



Not only do we have the right board for you, see all of our markerboard accessories on pp. 32-33!



Please refer to p. 2 for a description of symbols.



Porcelain Steel Markerboard

- » Porcelain steel markerboards are engineered for superior color contrast with markers. Featured with Deluxe Aluminum Trim.
- » GREENGUARD Indoor Air Quality Certified® and GREENGUARD Children & Schools CertifiedSM.
- » Class A Fire Rated board. A full test report copy is available upon request.
- » Dry erase surface provides smooth writability and easy erasability with no ghosting.
- » Made in the USA. TAA compliant. 50 year guarantee.

A Porcelain Steel - Deluxe Aluminum Trim			
Part No.	H x W	Ship Wt.	Price
202AA*	1 1/2'H x 2'W	12 lbs	\$69.65
202AB*	2'H x 3'W	22 lbs	\$121.85
202AC**	3'H x 4'W	25 lbs	\$226.00
202AD	4'H x 4'W	69 lbs	\$269.13
202AE	3'H x 5'W	68 lbs	\$286.27
202AF	4'H x 5'W	110 lbs	\$332.01
202AG	4'H x 6'W	122 lbs	\$394.25
202AH	4'H x 8'W	145 lbs	\$520.35
202AK	4'H x 10'W	180 lbs	\$652.90
202AM	4'H x 12'W	222 lbs	\$780.20
202AP	4'H x 16'W	290 lbs	\$1,035.36

Porcelain Steel - Unframed			
Part No.	Item	Ship Wt.	Price
202X	Foil Back (per sq. ft.)	5 lbs	\$12.04
203X	Sheet Back (per sq. ft.)	5 lbs	\$14.62



Please refer to p. 2 for a description of symbols.

El Grande Board with Deluxe Aluminum Trim

- » The El Grande Board is 5' tall to accommodate younger users or to meet ADA requirements.
- » Available with porcelain steel markerboard or gray porcelain steel Projection Plus® surface.
- » Projection Plus® reduces surface glare by 60%, making it an ideal projection surface.
- » Framed in anodized aluminum with a map rail and rubber Dura-Safe® end caps.
- » Made in the USA. TAA compliant. 50 year guarantee.

El Grande Porcelain Steel Markerboard			
Part No.	HxW	Ship Wt.	Price
202AJ	5'H x 8'W	180 lbs	\$796.55
202AL	5'H x 10'W	225 lbs	\$1,064.78
202AN	5'H x 12'W	270 lbs	\$1,285.43
202AQ	5'H x 16'W	360 lbs	\$1,697.25

El Grande Projection Plus® Porc. Steel Markerboard			
Part No.	HxW	Ship Wt.	Price
204AJ	5'H x 8'W	180 lbs	\$928.43
204AL	5'H x 10'W	225 lbs	\$1,176.49
204AN	5'H x 12'W	270 lbs	\$1,405.86
204AQ	5'H x 16'W	360 lbs	\$1,865.58

Available with a Projection Plus® surface!

Markerboards: Porcelain Steel Markerboards



Please refer to p. 2 for a description of symbols.



Porcelain Steel Markerboard with Solid Wood Trim

- » Porcelain steel markerboards are engineered for superior color contrast with markers. Dry erase surface provides smooth writability and easy erasability with no ghosting.
- » Featured with solid wood trim available in natural or mahogany finish to add an element of warmth and tradition to any environment.
- » Made in the USA. TAA compliant. 50 year guarantee.

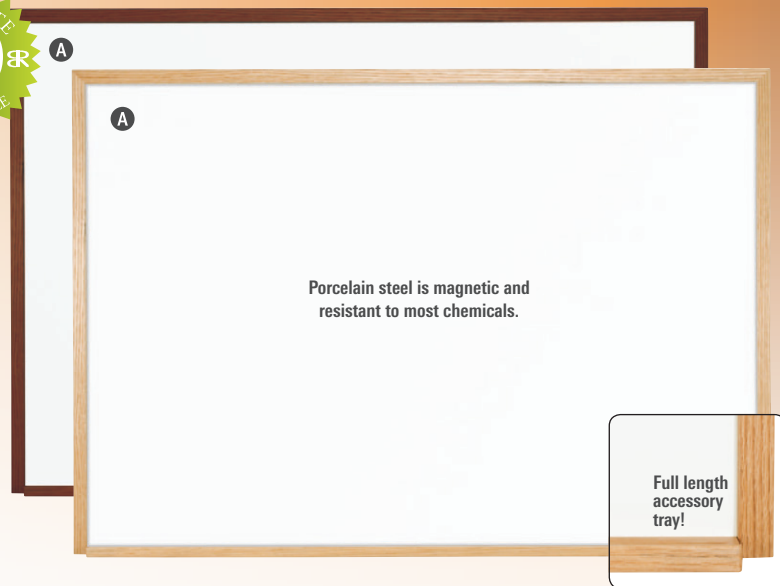

Porcelain steel is magnetic and resistant to most chemicals.

Full length accessory tray!

4 Porcelain Steel Markerboard - Solid Wood Trim

Natural	Mahogany	HxW	Ship Wt.	Price
202WA*	M202WA*	1 1/2'H x 2'W	12 lbs	\$78.51
202WB*	M202WB*	2'H x 3'W	22 lbs	\$137.32
202WC**	M202WC**	3'H x 4'W	25 lbs	\$254.83
202WD	M202WD	4'H x 4'W	69 lbs	\$303.81
202WE	M202WE	3'H x 5'W	68 lbs	\$322.73
202WF	M202WF	4'H x 5'W	110 lbs	\$374.35
202WG	M202WG	4'H x 6'W	122 lbs	\$444.52
202WH	M202WH	4'H x 8'W	145 lbs	\$586.65
202WK	M202WK	4'H x 10'W	180 lbs	\$733.31
202WM	M202WM	4'H x 12'W	222 lbs	\$879.97
202WP	M202WP	4'H x 16'W	290 lbs	\$1,173.30

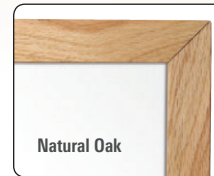

See matching tackboard on p. 37!



Please refer to p. 2 for a description of symbols.

Projection Plus® with Deluxe Aluminum Trim

- » The Projection Plus® Board is the only markerboard that doubles as a projection surface.
- » Light gray porcelain steel surface reflects 60% less glare than standard white board surfaces.
- » Surface requires cleaning with a damp cloth for optimum use. Some ghosting may occur.
- » Also available in a 5' board height. Call for details.
- » Made in the USA. TAA compliant. 50 year guarantee.

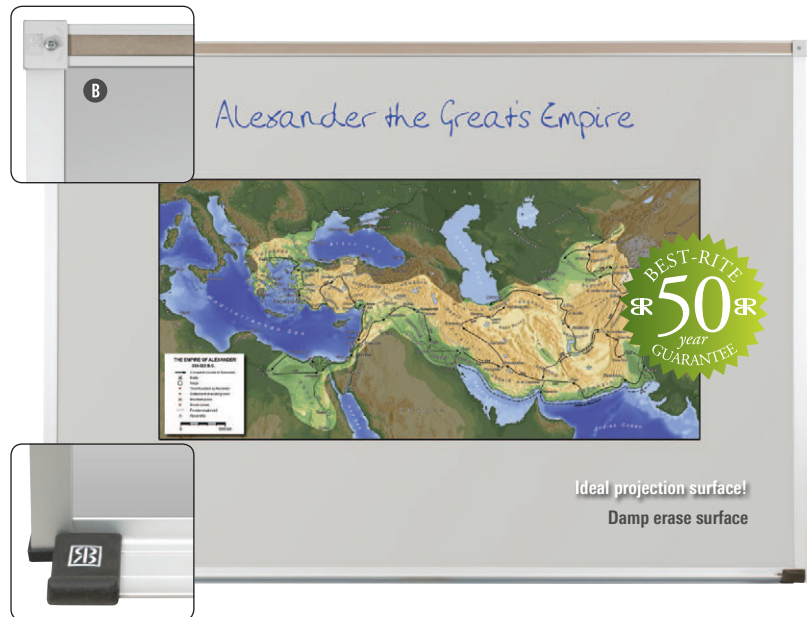

Ideal projection surface!
Damp erase surface



6 Projection Plus®-Deluxe Aluminum Trim

Part No.	HxW	Ship Wt.	Price
204AC**	3'H x 4'W	12 lbs	\$281.84
204AD	4'H x 4'W	22 lbs	\$337.85
204AE	3'H x 5'W	25 lbs	\$352.77
204AF	4'H x 5'W	69 lbs	\$415.84
204AG	4'H x 6'W	68 lbs	\$493.93
204AH	4'H x 8'W	110 lbs	\$652.17
204AK	4'H x 10'W	25 lbs	\$818.25
204AM	4'H x 12'W	69 lbs	\$978.01
204AP	4'H x 16'W	68 lbs	\$1,297.77

Projection Plus® - Unframed

Part No.	Item	Ship Wt.	Price
204X	204 Foil Back	4 1/2 lbs	\$15.23
205X	205 Sheet Back	4 1/2 lbs	\$18.47

A Trim features colored injection-molded corner pieces to add a touch of brightness to any room.

BEST-RITE
50 year GUARANTEE

Colored trim coordinates with Brite Kids® Early Childhood Furniture. See pp. 160-161!

Magnetic Q-Tray included!

Please specify color when ordering.

Blue (T2) Red (T3) Green (T4)

See matching tackboard on p. 39!



Please refer to p. 2 for a description of symbols.

Porcelain Steel Markerboard with Brite Trim

- » Porcelain steel surface is featured with colorful Brite Trim, anodized aluminum accented with colorful corner pieces to enliven any environment.
- » GREENGUARD Indoor Air Quality Certified® and GREENGUARD Children & Schools CertifiedSM.
- » Class A Fire Rated board. A full test report available upon request.
- » Surface provides superior writability, and is virtually indestructible. Magnetic Q-Tray included.
- » Made in the USA. 50 year guarantee. GSA/TAA compliant.

4 Porcelain Steel Markerboard - Brite Trim

Blue	Red	Green	HxW	Ship Wt.	Price
2H2PA-T2*	2H2PA-T3*	2H2PA-T4*	1 1/2'H x 2'W	12 lbs	\$66.00
2H2PB-T2*	2H2PB-T3*	2H2PB-T4*	2'H x 3'W	22 lbs	\$115.20
2H2PC-T2**	2H2PC-T3**	2H2PC-T4**	3'H x 4'W	25 lbs	\$185.50
2H2PD-T2	2H2PD-T3	2H2PD-T4	4'H x 4'W	69 lbs	\$249.10
2H2PE-T2	2H2PE-T3	2H2PE-T4	3'H x 5'W	68 lbs	\$231.40
2H2PF-T2	2H2PF-T3	2H2PF-T4	4'H x 5'W	110 lbs	\$298.20
2H2PG-T2	2H2PG-T3	2H2PG-T4	4'H x 6'W	122 lbs	\$302.10
2H2PH-T2	2H2PH-T3	2H2PH-T4	4'H x 8'W	145 lbs	\$421.88
2H2PK-T2	2H2PK-T3	2H2PK-T4	4'H x 10'W	180 lbs	\$524.80
2H2PM-T2	2H2PM-T3	2H2PM-T4	4'H x 12'W	222 lbs	\$620.10

B Class A Fire Rated Board!

Trim accented with matching brushed aluminum corner caps.

Porcelain steel surface at an economical price!

Superior porcelain steel surface doubles as a magnetic bulletin board.

Black plastic end caps on the accessory tray eliminate sharp corners.



Please refer to p. 2 for a description of symbols.

Porcelain Steel Markerboard with ABC Trim

- » The ABC Board provides a more economical porcelain steel surface without sacrificing quality.
- » Class A Fire Rated board. A full test report copy is available upon request.
- » Offers superior writability, erasability, and color contrast. Doubles as a magnetic bulletin board.
- » Made in the USA. TAA compliant. 50 year guarantee.

6 Porcelain Steel Markerboard - ABC Trim

Part No.	HxW	Ship Wt.	Price
■ 2H2NA*	1 1/2'H x 2'W	24 lbs	\$67.26
■ 2H2NB*	2'H x 3'W	29 lbs	\$117.56
■ 2H2NC**	3'H x 4'W	32 lbs	\$219.18
■ 2H2ND	4'H x 4'W	69 lbs	\$271.10
■ 2H2NE	3'H x 5'W	65 lbs	\$240.53
■ 2H2NF	4'H x 5'W	73 lbs	\$320.71
■ 2H2NG	4'H x 6'W	77 lbs	\$384.15
■ 2H2NH	4'H x 8'W	98 lbs	\$433.75
■ 2H2NK	4'H x 10'W	110 lbs	\$507.74
■ 2H2NM	4'H x 12'W	125 lbs	\$604.20

Give it a shot!

Cleaner & Accessories pp. 32-33.

See matching tackboard on p. 36!

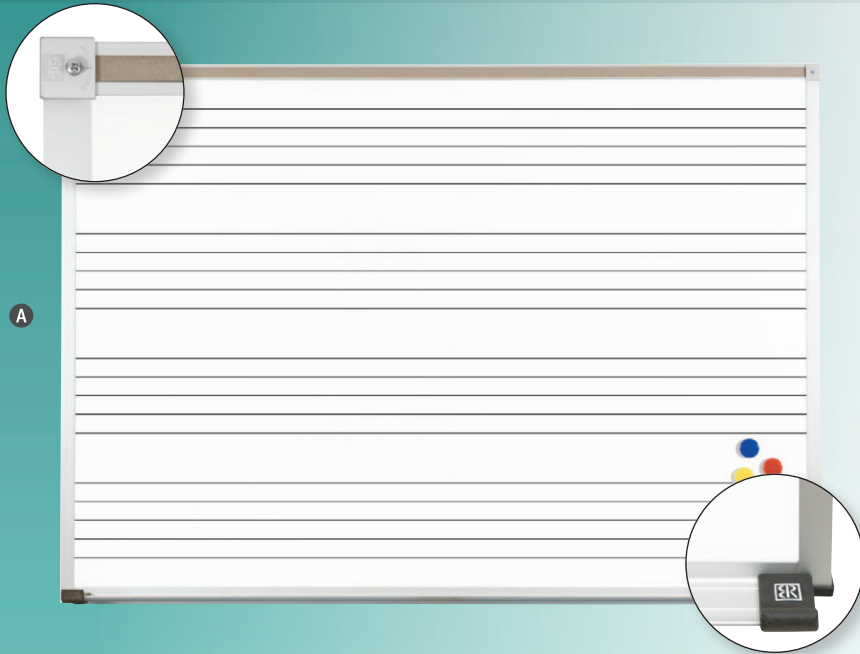

A

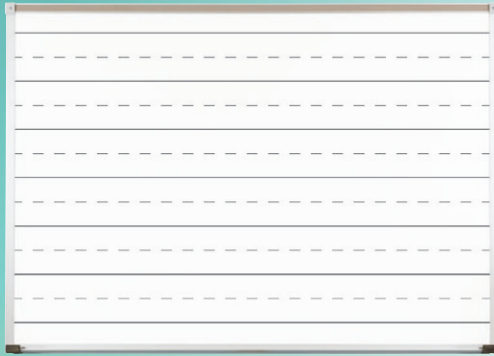

B

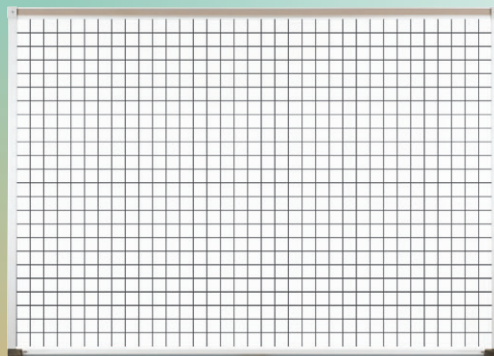

C

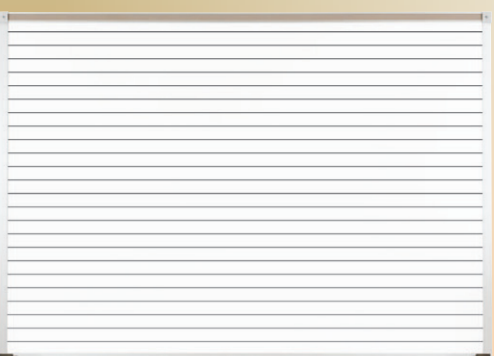

D

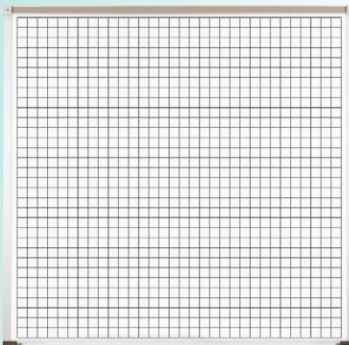

E



F



Please refer to p. 2 for a description of symbols.

Graphic Surfaces

- » Graphic Boards feature useful graphics permanently embedded into the board surface.
- » Available graphics include music lines, horizontal lines, grid lines, penmanship lines and maps.
- » Boards available with a superior porcelain steel surface. 50 year guarantee.
- » Made in the USA. TAA compliant.

A Music Line Surface			
Part No.	HxW	Ship Wt.	Price
202AG-S1	4'H x 6'W	122 lbs	\$669.85
202AH-S1	4'H x 8'W	145 lbs	\$883.99
202AK-S1	4'H x 10'W	180 lbs	\$1,108.56

B Penmanship Line Surface			
Part No.	HxW	Ship Wt.	Price
202AG-S2	4'H x 6'W	122 lbs	\$669.85
202AH-S2	4'H x 8'W	145 lbs	\$883.99
202AK-S2	4'H x 10'W	180 lbs	\$1,108.56

C Grid Line Surface			
Part No.	HxW	Ship Wt.	Price
202AH-S4	4'H x 8'W	145 lbs	\$883.99

D Horizontal Line Surface			
Part No.	HxW	Ship Wt.	Price
202AH-S3	4'H x 8'W	145 lbs	\$883.99

E Coordinate Line Surface			
Part No.	HxW	Ship Wt.	Price
604	4'H x 4'W	69 lbs	\$307.67

F USA Map Surface			
Part No.	HxW	Ship Wt.	Price
202AD-M5	4'H x 4'W	69 lbs	\$385.90

See matching graphic reversible boards on pp. 60-61!





Please refer to p. 2 for a description of symbols.

Dura-Rite® Markerboard with Deluxe Aluminum Trim

- » Dura-Rite® Boards provides a wear-resistant surface at an affordable price
- » HPL provides smooth writability and easy erasability.
- » Trimmed in anodized aluminum with a full-length map rail.
- » Full-length accessory tray includes rubber Dura-Safe® end caps.
- » Made in USA. TAA compliant. 20 year guarantee.

A Dura-Rite® - Deluxe Aluminum Trim			
Part No.	HxW	Ship Wt.	Price
212AA*	1 1/2'H x 2'W	5 lbs	\$48.23
212AB*	2'H x 3'W	12 lbs	\$85.20
212AC**	3'H x 4'W	22 lbs	\$121.11
212AD	4'H x 4'W	26 lbs	\$172.19
212AE	3'H x 5'W	28 lbs	\$161.43
212AF	4'H x 5'W	51 lbs	\$206.35
212AG	4'H x 6'W	63 lbs	\$247.51
212AH	4'H x 8'W	78 lbs	\$323.06
212AK	4'H x 10'W	85 lbs	\$442.44
212AM	4'H x 12'W	101 lbs	\$523.03

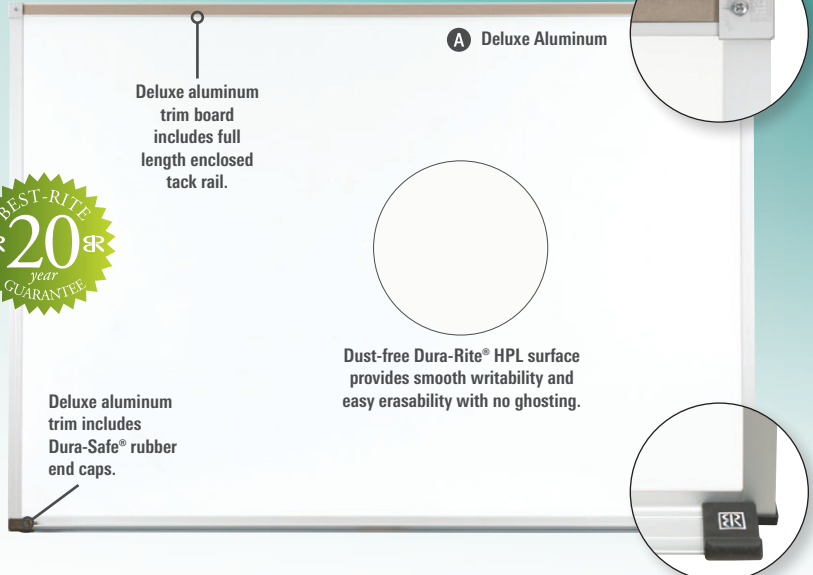

Labor test results:
Dura-Rite® lasts up to 125 times longer than melamine!



Please refer to p. 2 for a description of symbols.

Dura-Rite® Markerboard with ABC Trim

- » Same great amenities as the Dura-Rite® Markerboard with Aluminum Trim, only without the map rail.
- » Trimmed in anodized aluminum with a full-length accessory tray.
- » Made in USA. TAA compliant. 20 year guarantee.

B Dura-Rite® - ABC Trim			
Part No.	HxW	Ship Wt.	Price
212NA*	1 1/2'H x 2'W	5 lbs	\$57.17
212NB*	2'H x 3'W	12 lbs	\$99.93
212NC**	3'H x 4'W	22 lbs	\$186.30
212ND	4'H x 4'W	26 lbs	\$230.44
212NE	3'H x 5'W	28 lbs	\$232.10
212NF	4'H x 5'W	51 lbs	\$270.40
212NG	4'H x 6'W	63 lbs	\$326.53
212NH	4'H x 8'W	78 lbs	\$368.69
212NK	4'H x 10'W	85 lbs	\$510.00
212NM	4'H x 12'W	101 lbs	\$630.00



Black plastic end caps on the accessory tray eliminate sharp corners.



Please refer to p. 2 for a description of symbols.

Magne-Rite Markerboard with Deluxe Aluminum Trim

- » The Magne-Rite board features a surface of PVC-coated steel.
- » Excellent writability and erasability and doubles as a magnetic bulletin board
- » Full-length map rail and a full-length accessory tray with rubber Dura-Safe® end caps.
- » 10 year guarantee. TAA compliant. Made in the USA.

A Magne-Rite - Deluxe Aluminum Trim

Part No.	HxW	Ship Wt.	Price
219AA*	1 1/2'H x 2'W	12 lbs	\$52.15
219AB*	2'H x 3'W	22 lbs	\$104.03
219AC**	3'H x 4'W	25 lbs	\$191.12
219AD	4'H x 4'W	69 lbs	\$227.89
219AE	3'H x 5'W	68 lbs	\$209.92
219AF	4'H x 5'W	68 lbs	\$279.89
219AG	4'H x 6'W	122 lbs	\$333.37
219AH	4'H x 8'W	145 lbs	\$439.94

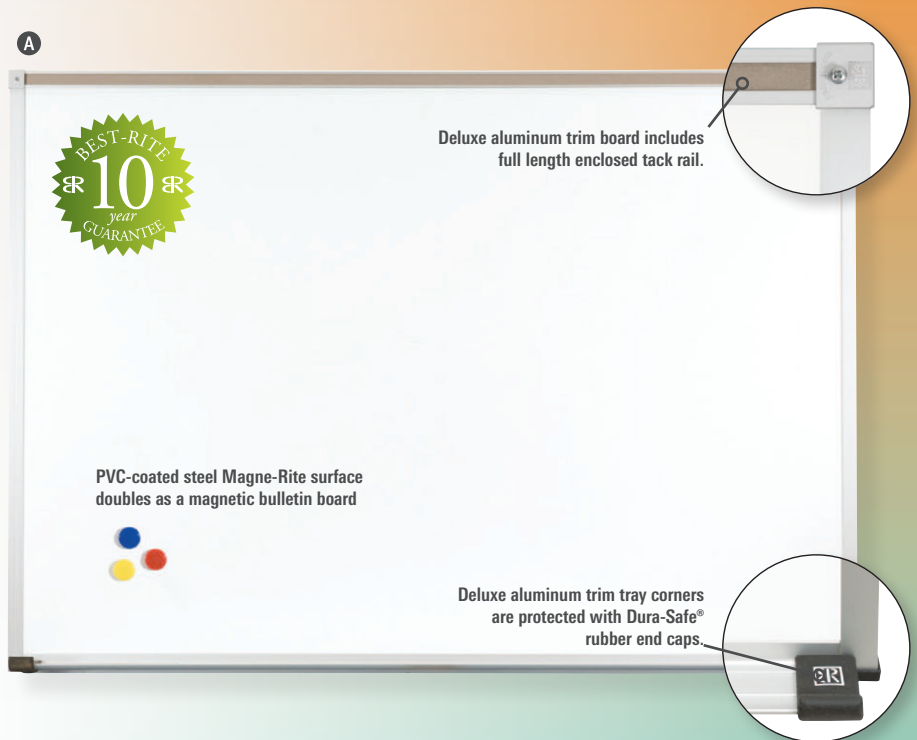

Please refer to p. 2 for a description of symbols.

Magne-Rite Markerboard with ABC Trim

- » Magne-Rite dry erase markerboard is a specially-engineered PVC-coated steel.
- » The surface provides exceptionally smooth writability and erases cleanly with no ghosting.
- » Framed in anodized aluminum.
- » 10 year guarantee. TAA compliant. Made in the USA.

B Magne-Rite - ABC Trim

Part No.	HxW	Ship Wt.	Price
219NA*	1 1/2'H x 2'W	12 lbs	\$45.24
219NB*	2'H x 3'W	22 lbs	\$90.48
219NC**	3'H x 4'W	25 lbs	\$165.21
219ND	4'H x 4'W	69 lbs	\$194.42
219NE	3'H x 5'W	68 lbs	\$186.03
219NF	4'H x 5'W	68 lbs	\$248.03
219NG	4'H x 6'W	122 lbs	\$272.56
219NH	4'H x 8'W	145 lbs	\$343.82





Cleaner & Accessories pp. 32-33.



Available with a pale gray dot pattern to enable straighter writing and drawing.



Please refer to p. 2 for a description of symbols.

TuF-Rite™ Markerboard with ABC Trim

- » New TuF-Rite™ surface provides a vast improvement over standard economy melamine boards. Thermal fuse technology improves erasability and lasts up to three times as long.
- » Available with a pale gray dot grid pattern for easier writing and drawing.
- » Featured with anodized aluminum trim with aluminum corner caps and a full-length accessory tray with plastic end caps.
- » 5 year guarantee.

● TuF-Rite™ - ABC Trim

Standard	Dot Grid	HxW	Ship Wt.	Price (Std)	Price (Dot)
2H1NA*	2H1NA-S4*	1 1/2'H x 2'W	4 lbs	\$40.00	\$45.00
2H1NB*	2H1NB-S4*	2'H x 3'W	12 lbs	\$55.00	\$61.00
2H1NC**	2H1NC-S4**	3'H x 4'W	22 lbs	\$89.00	\$98.00
2H1ND	2H1ND-S4	4'H x 4'W	25 lbs	\$145.00	\$156.57
2H1NE	2H1NE-S4	3'H x 5'W	24 lbs	\$178.00	\$189.00
2H1NF	2H1NF-S4	4'H x 5'W	60 lbs	\$182.00	\$195.00
2H1NG	2H1NG-S4	4'H x 6'W	62 lbs	\$210.00	\$223.00
2H1NH	2H1NH-S4	4'H x 8'W	77 lbs	\$283.00	\$296.00



Please refer to p. 2 for a description of symbols.

Green Erase™
Eco Friendly Multi-Purpose Cleaner

- » Green Erase™ environmentally responsible multi-purpose cleaner is made from readily biodegradable ingredients.
- » Available in ready to use or in concentrate formula.
- » Easily cleans marker from any dry erase surface with no streaking or ghosting.
- » Recognized for Safer Chemistry by the EPA.
- » Made in the USA. TAA compliant.



Recognized for safer chemistry by the EPA.
www.epa.gov/dfe



Scan this QR code to watch our corkboards online video.

Visit Us Online!
www.cleanyourwhiteboard.com

A Green Erase™ Cleaner - Ready To Use			
Part No.	Size	Ship Wt.	Price
580*	1 qt. bottle	4 lbs	\$12.97
B Green Erase™ Cleaner - Concentrate			
Part No.	Size	Ship Wt.	Price
581*	1 qt. bottle	4 lbs	\$18.20

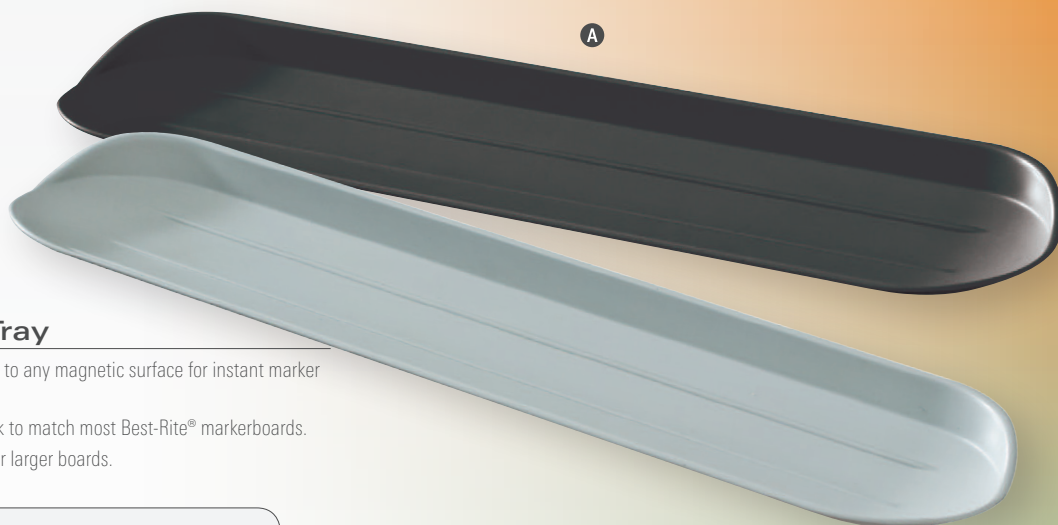

Magnetic Q-Tray

- » Magnetic Q-Trays attach to any magnetic surface for instant marker and eraser storage.
- » Available in gray or black to match most Best-Rite® markerboards.
- » Purchase two or more for larger boards.

● Magnetic Q-Tray				
Part No.	Color	HxW	Ship Wt.	Price
MT-16*	Black	1 1/4"H x 16 1/4"W	1/2 lb	\$24.57
MT-16G*	Gray	1 1/4"H x 16 1/4"W	1/2 lb	\$24.57

Rite-On® Markers

- » Rite-On® Markers are specially engineered for optimum results with Best-Rite® dry erase surfaces.
- » Markers provide excellent color contrast and erase easily and cleanly.
- » Pack of four includes four colors: black, blue, green, and red.

● Rite-On® Markers				
Part No.	Colors	HxW	Ship Wt.	Price
554E4*	Set of 4	6"H x 3"W	1/4 lb	\$4.19



Magnetic Eraser Cloth

- » The Magnetic Eraser Cloth features a magnet sewn into one corner to easily attach to any magnetic surface.
- » Cloth wipes dry erase marker cleanly and with no ghosting.
- » Ideal for boards without a tray, the cloth conveniently stores wherever it is needed.

● Magnetic Eraser Cloth				
Part No.	Color	HxW	Ship Wt.	Price
555*	Black	10"H x 10"W	1/4 lb	\$1.64



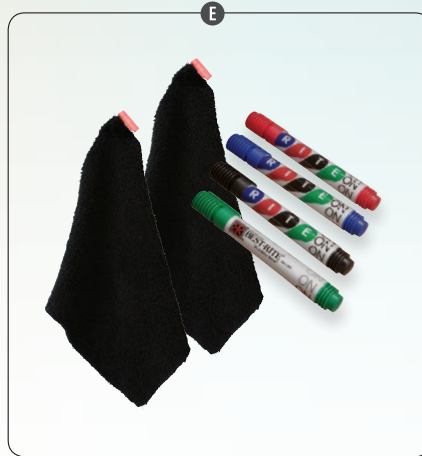

Visit Us Online!
www.cleanyourwhiteboard.com

See more online!
youtube.com/moorecoin



Please refer to p. 2 for a description of symbols.

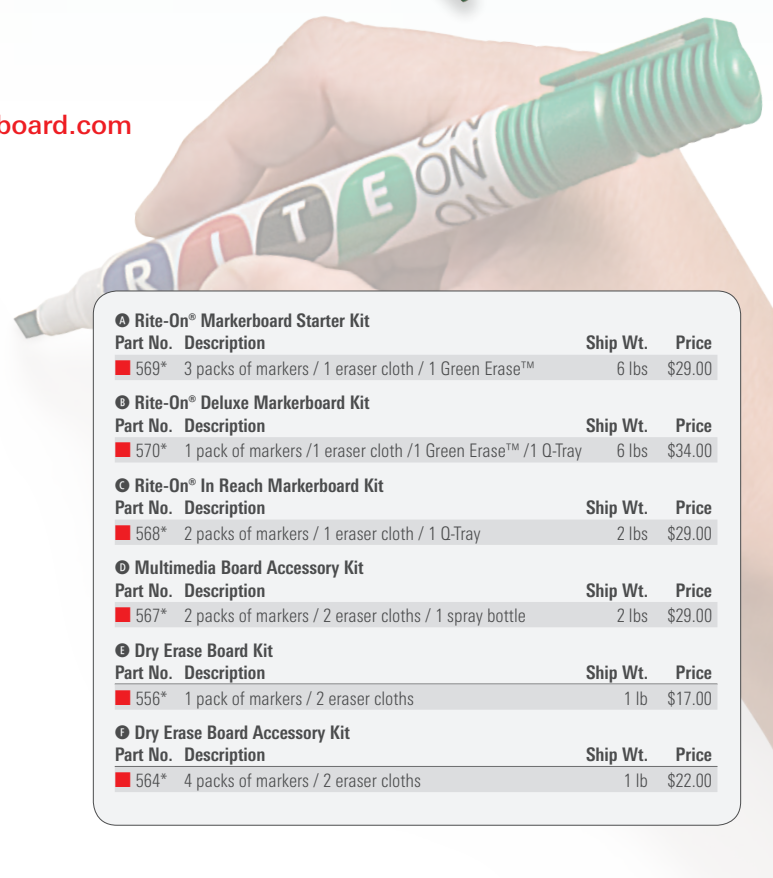

Markerboard Accessory Kits

- A. Rite-On® Markerboard Starter Kit** - Kit includes 12 Rite-On® Dry Erase Markers, one Magnetic Eraser Cloth, and a one quart bottle of Green Erase™ Eco-Friendly Whiteboard Cleaner.
- B. Rite-On® Deluxe Markerboard Kit** - Includes 4 Rite-On® Dry Erase Markers, one Magnetic Eraser Cloth, one Magnetic Q-Tray and a one quart bottle of Green Erase™ Eco-Friendly Whiteboard Cleaner.
- C. Rite-On® In Reach Markerboard Kit** - Includes Magnetic Q-Tray, eight Rite-On® dry erase markers, and one Magnetic Eraser Cloth.
- D. Multimedia Board Accessory Kit** - Developed for use with damp erase boards, the Multimedia Board Accessory Kit includes two packages of Rite-On™ Markers, two Magnetic Eraser Cloths, and one spray bottle.
- E. Dry Erase Board Kit** - Includes one set of Rite-On™ Markers and two Magnetic Eraser Cloths.
- F. Dry Erase Board Accessory Kit** - Includes four packages of Rite-On™ Markers and two Magnetic Eraser Cloths.

Part No.	Description	Ship Wt.	Price
569*	3 packs of markers / 1 eraser cloth / 1 Green Erase™	6 lbs	\$29.00
570*	1 pack of markers / 1 eraser cloth / 1 Green Erase™ / 1 Q-Tray	6 lbs	\$34.00
568*	2 packs of markers / 1 eraser cloth / 1 Q-Tray	2 lbs	\$29.00
567*	2 packs of markers / 2 eraser cloths / 1 spray bottle	2 lbs	\$29.00
556*	1 pack of markers / 2 eraser cloths	1 lb	\$17.00
564*	4 packs of markers / 2 eraser cloths	1 lb	\$22.00

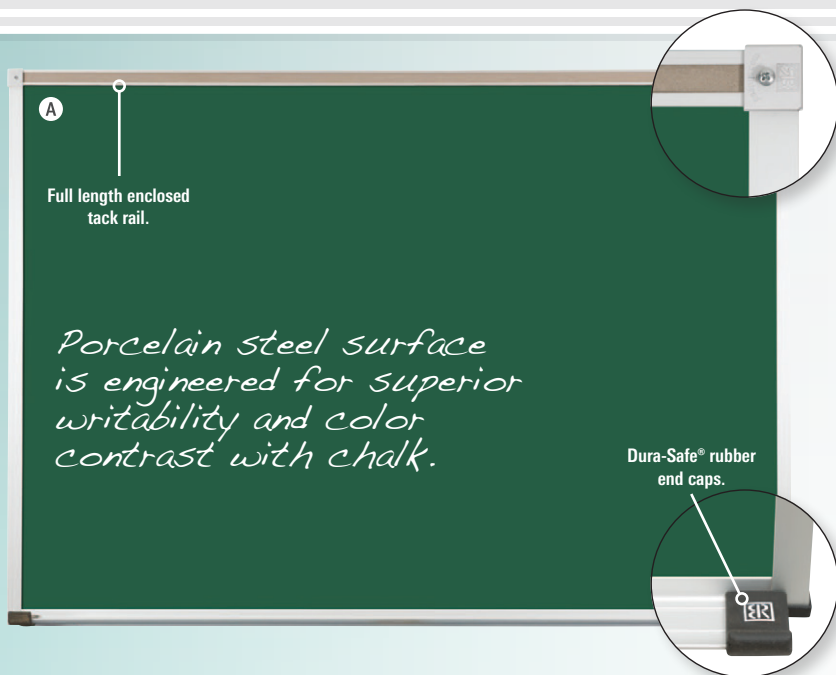

Full length enclosed tack rail.

Porcelain steel surface is engineered for superior writability and color contrast with chalk.

Dura-Safe® rubber end caps.

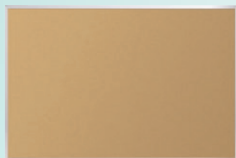

See matching tackboard on p. 36!

Green (20)

Black (23)



Porcelain Steel Chalkboard with Deluxe Aluminum Trim

- » The Porcelain Steel Chalkboard features a fine-tooth abrasive finish and superior color contrast that makes chalk easier to read.
- » Vitrified porcelain surface erases without ghosting, and is colorfast and non-fading.
- » Surface also doubles as a magnetic bulletin board.
- » Clean up is easy with ammonia and water.
- » Made in the USA. TAA compliant. 50 year guarantee.

A Porcelain Steel Chalkboard - Deluxe Alum. Trim

Part No.	HxW	Ship Wt.	Price
104AA*	1 1/2'H x 2'W	12 lbs	\$74.38
104AB*	2'H x 3'W	22 lbs	\$128.92
104AC**	3'H x 4'W	25 lbs	\$240.50
104AD	4'H x 4'W	69 lbs	\$287.57
104AE	3'H x 5'W	68 lbs	\$305.02
104AF	4'H x 5'W	110 lbs	\$353.30
104AG	4'H x 6'W	122 lbs	\$419.02
104AH	4'H x 8'W	145 lbs	\$559.49
104AK	4'H x 10'W	180 lbs	\$695.50
104AM	4'H x 12'W	222 lbs	\$830.69
104AP	4'H x 16'W	290 lbs	\$1,102.11

Porcelain Steel Chalkboard - Unframed

Part No.	Item	Ship Wt.	Price
104X	Std Backer (per sq. ft.)	4 1/2 lbs	\$12.41
105X	Sheet Backer (per sq. ft.)	4 1/2 lbs	\$15.07

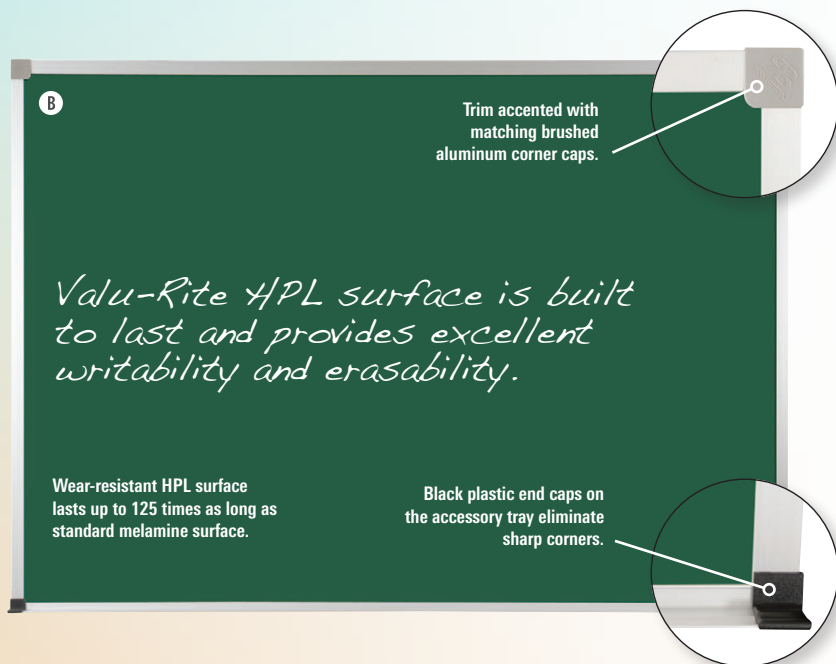

Trim accented with matching brushed aluminum corner caps.

Wear-resistant HPL surface lasts up to 125 times as long as standard melamine surface.

Valu-Rite HPL surface is built to last and provides excellent writability and erasability.

Black plastic end caps on the accessory tray eliminate sharp corners.

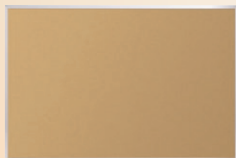

See matching tackboard on p. 37!

Valu-Rite Green



Valu-Rite Chalkboard with ABC Trim

- » The Valu-Rite chalkboard features an exceptionally durable high pressure laminate surface.
- » Excellent writability and erasability with chalk.
- » Cleans easily with detergent and water. No chalking is necessary after cleaning.
- » Made in the USA. TAA compliant. 20 year guarantee.

B Valu-Rite Chalkboard - ABC Trim

Part No.	HxW	Ship Wt.	Price
101AA*	1 1/2'H x 2'W	5 lbs	\$27.56
101AB*	2'H x 3'W	12 lbs	\$48.40
101AC**	3'H x 4'W	22 lbs	\$82.95
101AD	4'H x 4'W	31 lbs	\$136.00
101AE	3'H x 5'W	28 lbs	\$157.99
101AF	4'H x 5'W	35 lbs	\$171.94
101AG	4'H x 6'W	42 lbs	\$196.42
101AH	4'H x 8'W	86 lbs	\$256.57
101AK	4'H x 10'W	90 lbs	\$324.33
101AM	4'H x 12'W	95 lbs	\$385.49

Valu-Rite Chalkboard - Unframed

Part No.	Item	Ship Wt.	Price
101X	Std Backer (per sq. ft.)	4 1/2 lbs	\$4.09

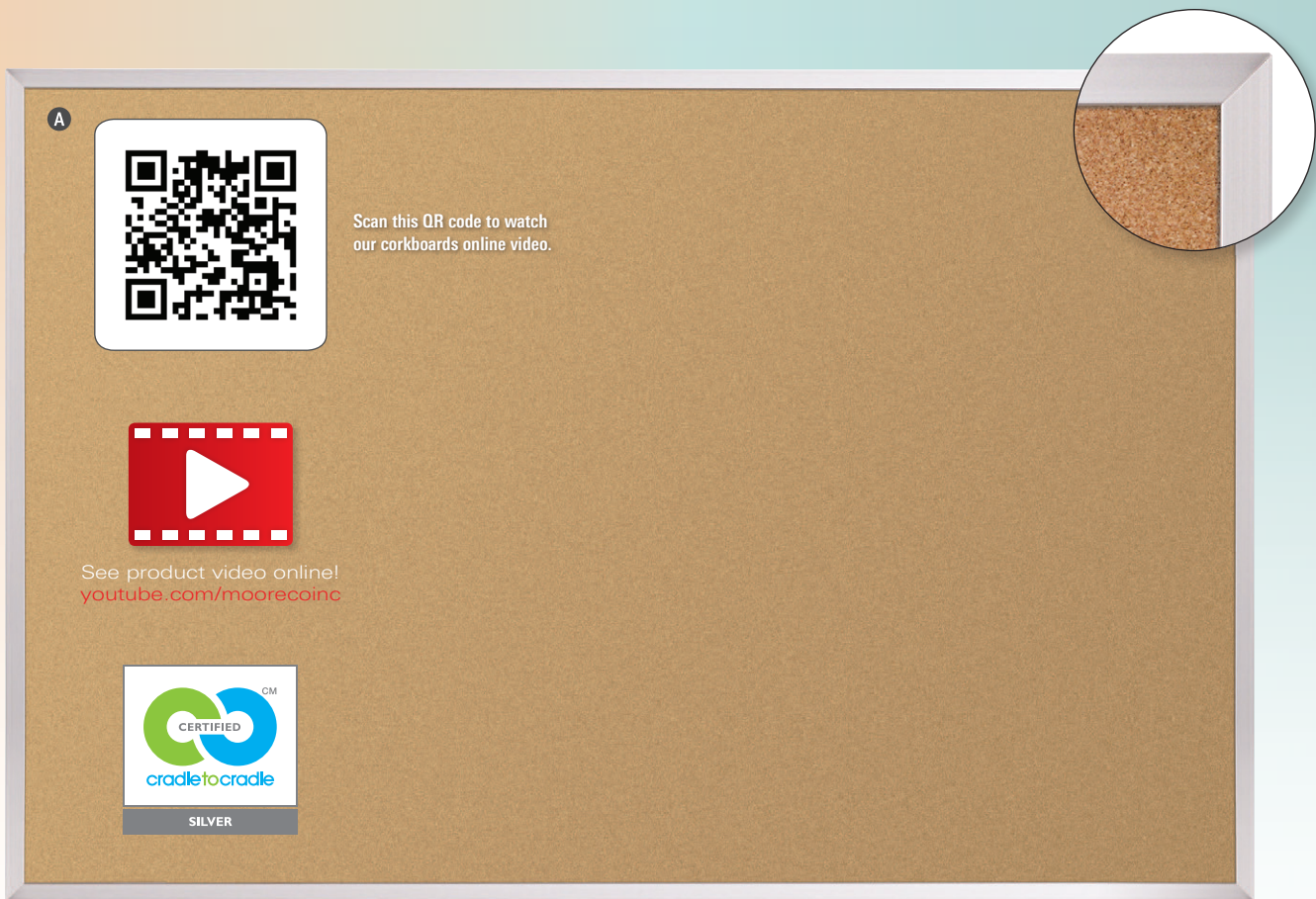

Cradle to Cradle Certified^{CM} is a certification mark of MBDC.



Please refer to p. 2 for a description of symbols.

VT Logic Tackboard with Standard Aluminum Trim

- » Eco-friendly VT Logic natural cork surface is featured with Aluminum Trim for a traditional and economical board.
- » Cradle to Cradle Certified^{CM} - Silver, GREENGUARD Indoor Air Quality Certified[®] and GREENGUARD Children & Schools CertifiedSM.
- » Certified boards incorporate material healthfulness, material reutilization, renewable energy use, water stewardship and social responsibility.
- » Completely recyclable surface is bonded to insulation board for superb tack-holding ability. Surface is durable and self-healing.
- » Made in the USA. TAA compliant. 10 year guarantee.



VT Logic Tackboard - Standard Aluminum Trim

Part No.	HxW	Ship Wt.	Price
E301AA*	1 1/2'H x 2'W	4 lbs	\$29.00
E301AB*	2'H x 3'W	9 lbs	\$52.50
E301AC**	3'H x 4'W	19 lbs	\$84.95
E301AD	4'H x 4'W	20 lbs	\$114.95

Part No.	HxW	Ship Wt.	Price
E301AG	4'H x 6'W	30 lbs	\$159.00
E301AH	4'H x 8'W	43 lbs	\$207.95
E301AK	4'H x 10'W	50 lbs	\$259.00
E301AM	4'H x 12'W	60 lbs	\$319.00

Valu-Tak Tackboard with Standard Aluminum Trim

- » Valu-Tak tackboards feature 1/16" 100% natural cork on a lightweight substrate.
- » Naturally renewable cork is durable, self-healing, and environmentally responsible.
- » GREENGUARD Indoor Air Quality Certified® and GREENGUARD Children & Schools CertifiedSM.
- » Made in the USA. TAA compliant. 10 year guarantee.

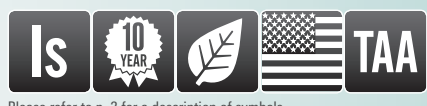

Please refer to p. 2 for a description of symbols.

Part No.	HxW	Ship Wt.	Price
301AA*	1 1/2'H x 2'W	4 lbs	\$28.67
301AB*	2'H x 3'W	9 lbs	\$46.82
301AC**	3'H x 4'W	19 lbs	\$78.25
301AD	4'H x 4'W	20 lbs	\$106.29
301AE	3'H x 5'W	19 lbs	\$122.19
301AF	4'H x 5'W	25 lbs	\$128.19
301AG	4'H x 6'W	30 lbs	\$150.35
301AH	4'H x 8'W	43 lbs	\$194.03
301AK	4'H x 10'W	50 lbs	\$247.62
301AM	4'H x 12'W	60 lbs	\$292.69



See product video online!
youtube.com/moorecoinc



Please refer to p. 2 for a description of symbols.

Valu-Tak Tackboard with Solid Wood Trim

- » Valu-Tak natural cork tackboards feature a 100% natural cork surface.
- » Natural cork surface is bonded to insulation board for superb tack-holding ability.
- » Naturally renewable surface is durable, self-healing, and environmentally responsible.
- » Solid wood trim available in natural oak or mahogany finishes.
- » Made in the USA. TAA compliant. 10 year guarantee.

Part No.	HxW	Ship Wt.	Price
301WA*	1 1/2'H x 2'W	4 lbs	\$35.55
301WB*	2'H x 3'W	9 lbs	\$50.95
301WC**	3'H x 4'W	19 lbs	\$89.77
301WD	4'H x 4'W	20 lbs	\$113.55
301WE	3'H x 5'W	19 lbs	\$130.44
301WF	4'H x 5'W	25 lbs	\$136.84
301WG	4'H x 6'W	30 lbs	\$160.48
301WH	4'H x 8'W	43 lbs	\$207.19
301WK	4'H x 10'W	50 lbs	\$299.23
301WM	4'H x 12'W	60 lbs	\$359.08

Part No.	HxW	Ship Wt.	Price
M301WA*	1 1/2'H x 2'W	4 lbs	\$35.55
M301WB*	2'H x 3'W	9 lbs	\$50.95
M301WC**	3'H x 4'W	19 lbs	\$89.77
M301WD	4'H x 4'W	20 lbs	\$113.55
M301WE	3'H x 5'W	19 lbs	\$130.44
M301WF	4'H x 5'W	25 lbs	\$136.84
M301WG	4'H x 6'W	30 lbs	\$160.48
M301WH	4'H x 8'W	43 lbs	\$207.19
M301WK	4'H x 10'W	50 lbs	\$299.23
M301WM	4'H x 12'W	60 lbs	\$359.08

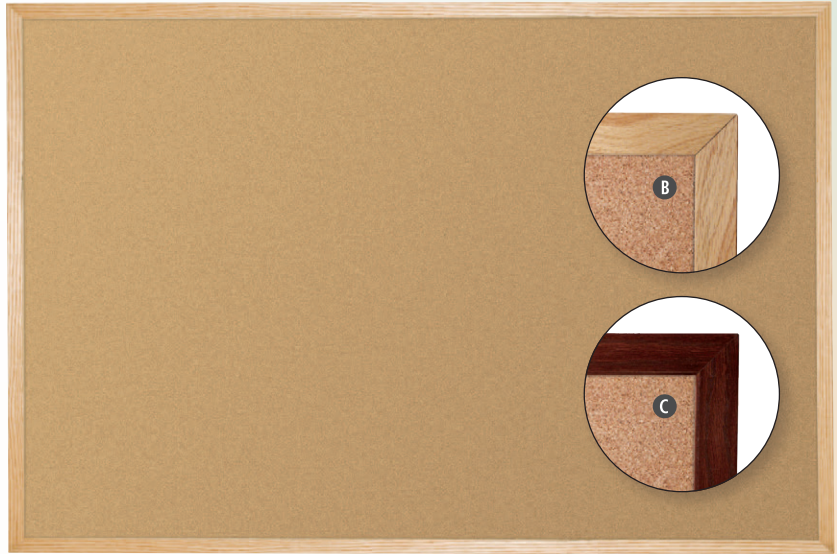

Natural Add-Cork Tackboard with Standard Aluminum Trim

- » Natural Add-Cork boards feature 1/8" cork over a thicker and more durable substrate.
- » GREENGUARD Indoor Air Quality Certified® and GREENGUARD Children & Schools CertifiedSM.
- » Naturally renewable cork is durable, self-healing, and environmentally responsible.
- » Made in the USA. TAA compliant. 10 year guarantee.

Natural Add-Cork Tackboard - Standard Aluminum Trim			
Part No.	HxW	Ship Wt.	Price
302AA*	1 1/2'H x 2'W	6 lbs	\$36.49
302AB*	2'H x 3'W	12 lbs	\$61.50
302AC**	3'H x 4'W	24 lbs	\$105.08
302AD	4'H x 4'W	32 lbs	\$133.69
302AG	4'H x 6'W	48 lbs	\$190.55
302AH	4'H x 8'W	64 lbs	\$260.15

Natural Add-Cork Tackboard - Unframed			
Part No.	Item	Ship Wt.	Price
302X	Add-Cork Panel / sq. ft.	1 1/2 lbs	\$4.81
304J	1/8" cork - cut to size / sq. ft.	1/4 lb	\$2.83
306J	1/8" cork - full roll 4' x 198'	98 lbs	\$2,081.38



Please refer to p. 2 for a description of symbols.

A

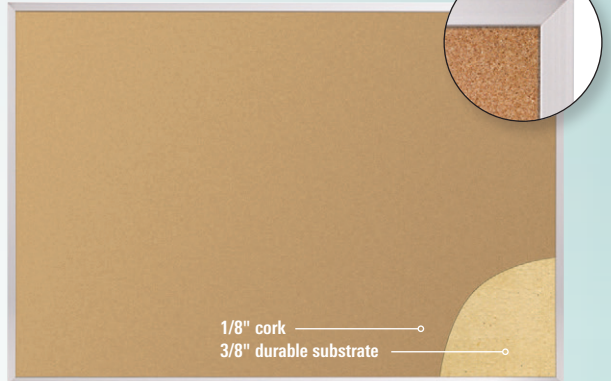

Natural Cork-Plate Tackboard with Standard Aluminum Trim

- » Natural Add-Cork boards feature 1/4" cork bonded to a moisture-resistant substrate.
- » Naturally renewable cork is durable, self-healing, and environmentally responsible.
- » GREENGUARD Indoor Air Quality Certified® and GREENGUARD Children & Schools CertifiedSM.
- » Made in the USA. TAA compliant. 10 year guarantee.

Natural Cork-Plate Tackboard - Standard Aluminum Trim			
Part No.	HxW	Ship Wt.	Price
303AA*	1 1/2'H x 2'W	8 lbs	\$44.67
303AB*	2'H x 3'W	17 lbs	\$84.48
303AC**	3'H x 4'W	33 lbs	\$152.00
303AD	4'H x 4'W	44 lbs	\$196.41
303AG	4'H x 6'W	66 lbs	\$285.36
303AH	4'H x 8'W	88 lbs	\$373.80

Natural Cork-Plate Tackboard - Unframed			
Part No.	Item	Ship Wt.	Price
303X	Cork Plate Panel / sq. ft.	1 1/2 lbs	\$9.49
305J	1/4" cork - cut to size / sq. ft.	1/4 lb	\$5.65
307J	1/4" cork - full roll 4' x 98'	98 lbs	\$1,951.53



Please refer to p. 2 for a description of symbols.

B

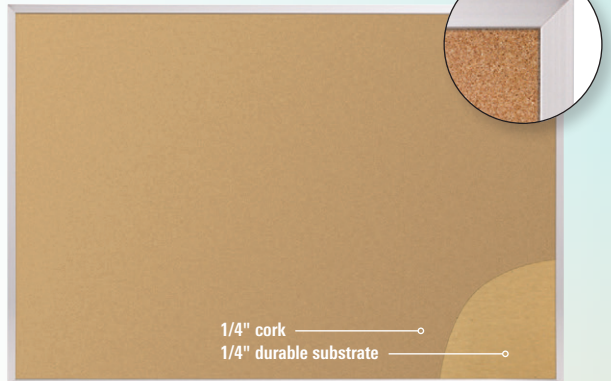

Sentinel AM™ Tackboard with Standard Aluminum Trim

- » Sentinel AM™ Antimicrobial Tackboard resists development of microbial odors, stains and discoloration due to bacteria, fungi (mold and mildew) and algae.
- » Tested using Antibacterial Test AATCC 147 *Staphylococcus aureus* and Antifungal Test AATCC Method 30 for *Aspergillus Niger*.
- » Resilient backing material. Available with standard aluminum or black Presidential trim.
- » Made in the USA. TAA compliant. 10 year guarantee.

Sentinel AM™ Tackboard - Standard Alum. Trim			
Part No.	HxW	Ship Wt.	Price
310AA*	1 1/2'H x 2'W	4 lbs	\$49.00
310AB*	2'H x 3'W	9 lbs	\$69.00
310AC**	3'H x 4'W	19 lbs	\$109.00
310AD	4'H x 4'W	20 lbs	\$159.00
310AG	4'H x 6'W	30 lbs	\$198.00
310AH*	4'H x 8'W	43 lbs	\$249.00



Natural cork surface treated to be antifungal and antimicrobial!



Please refer to p. 2 for a description of symbols.

C

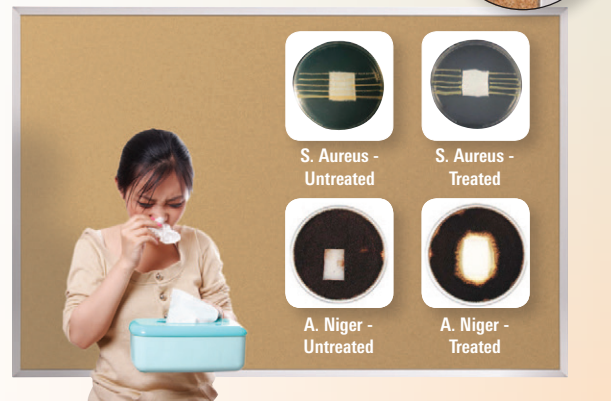

Splash-Cork Tackboard with Brite Trim

- » Splash-Cork boards provide a subtle splash of red, blue, or green color to any environment.
- » GREENGUARD Indoor Air Quality Certified® and GREENGUARD Children & Schools CertifiedSM.
- » Natural cork bonded with a tinted binder for a flexible, durable, and self-healing surface.
- » Trimmed in Brite Trim anodized aluminum with colored plastic corner caps to match board.
- » Made in the USA. TAA compliant. 10 year guarantee.

④ Splash-Cork Tackboard - Brite Trim			
Part No.	HxW	Ship Wt.	Price
300PA*	1 ½'H x 2'W	6 lbs	\$35.07
300PB*	2'H x 3'W	12 lbs	\$74.21
300PC**	3'H x 4'W	24 lbs	\$131.58
300PD	4'H x 4'W	32 lbs	\$149.88
300PG	4'H x 6'W	48 lbs	\$233.81
300PH	4'H x 8'W	64 lbs	\$306.30



Please refer to p. 2 for a description of symbols.

Please specify color: T2=blue, T3=red, T4=green.

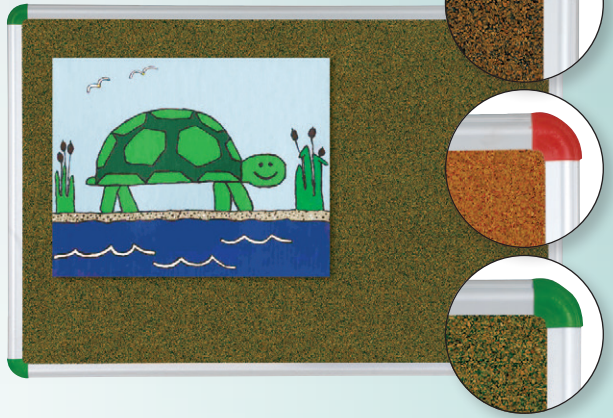

See matching Brite Trim markerboard on p. 27!

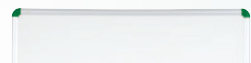

Splash-Cork Tackboard with Standard Aluminum Trim

- » Splash-Cork boards provide a subtle splash of red, blue, or green color to any environment.
- » GREENGUARD Indoor Air Quality Certified® and GREENGUARD Children & Schools CertifiedSM.
- » Made from cork bonded with a tinted binder, boards are flexible, durable and self-healing.
- » Made in the USA. TAA compliant. 10 year guarantee.

⑤ Splash-Cork Tackboard - Standard Alum. Trim			
Part No.	HxW	Ship Wt.	Price
300AA*	1 ½'H x 2'W	6 lbs	\$31.06
300AB*	2'H x 3'W	12 lbs	\$62.14
300AC**	3'H x 4'W	24 lbs	\$110.18
300AD	4'H x 4'W	32 lbs	\$140.90
300AG	4'H x 6'W	48 lbs	\$202.58
300AH	4'H x 8'W	64 lbs	\$265.39



Please refer to p. 2 for a description of symbols.



See matching markerboard on p. 24!

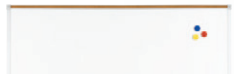

Splash-Cork Tackboard with Solid Oak Trim

- » Splash-Cork boards provide a subtle splash of red, blue, or green color to any environment.
- » Featured with solid oak trim in natural or mahogany.
- » Made from cork blended with a tinted binder, boards are flexible, durable and self-healing.
- » Made in the USA. TAA compliant. 10 year guarantee. Specify color when ordering.

⑥ Splash-Cork Tackboard - Solid Oak Trim				
Natural	Mahogany	HxW	Ship Wt.	Price
300WB*	M300WB*	2'H x 3'W	12 lbs	\$67.10
300WC**	M300WC**	3'H x 4'W	24 lbs	\$118.99
300WD	M300WD	4'H x 4'W	32 lbs	\$152.16
300WG	M300WG	4'H x 6'W	48 lbs	\$218.77
300WH	M300WH	4'H x 8'W	64 lbs	\$286.62



Please refer to p. 2 for a description of symbols.

Natural Oak Mahogany



See matching markerboard on p. 26!





Please refer to p. 2 for a description of symbols.

Colored Cork Tackboard with Standard Aluminum Trim

- » The Colored Cork-Plate Board is made with a Forbo® linoleum surface.
- » Made with natural linseed oil, granulated cork, rosin binders, and dry pigments.
- » Self-sanitizing quality inhibits contaminants.
- » Durable, self-healing, and colored throughout.
- » Made in the USA. TAA compliant. 10 year guarantee.

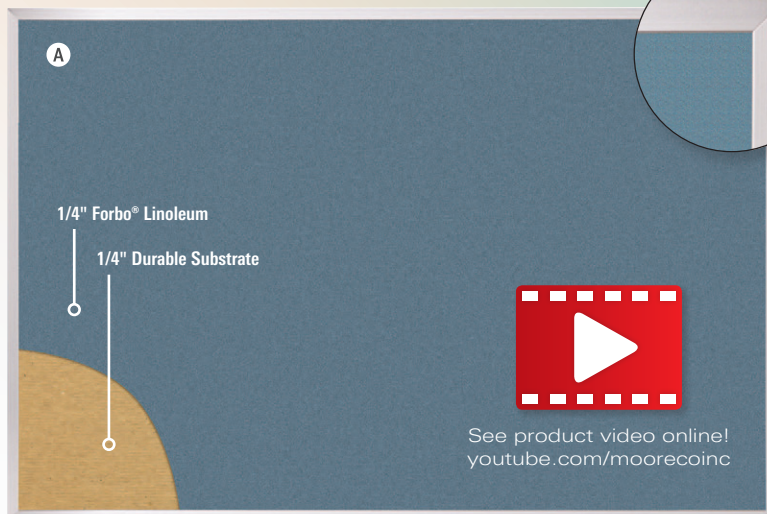

Colored Cork Tackboard - Aluminum Trim

Part No.	HxW	Ship Wt.	Price
322AA*	1 1/2'H x 2'W	8 lbs	\$65.36
322AB*	2'H x 3'W	17 lbs	\$122.68
322AC**	3'H x 4'W	33 lbs	\$229.60
322AD	4'H x 4'W	44 lbs	\$300.20
322AE	3'H x 5'W	42 lbs	\$367.56
322AF	4'H x 5'W	55 lbs	\$370.06
322AG	4'H x 6'W	66 lbs	\$441.04
322AH	4'H x 8'W	88 lbs	\$580.24
322AK	4'H x 10'W	110 lbs	\$726.47
322AM	4'H x 12'W	132 lbs	\$872.04

Please specify color when ordering.

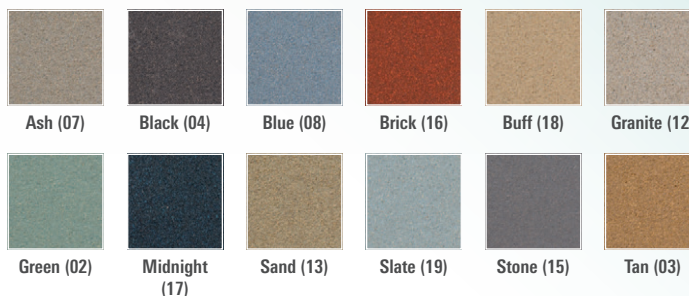

Please refer to p. 2 for a description of symbols.

Vinyl Add-Cork Tackboard with Standard Aluminum Trim

- » Fabric-backed vinyl over 1/8" cork and a lightweight substrate.
- » GREENGUARD Indoor Air Quality Certified® and GREENGUARD Children & Schools CertifiedSM.
- » Easy to clean. Treated to resist the growth of odor- and stain-causing microbes.
- » Made in the USA. TAA compliant. 10 year guarantee.

Vinyl Add-Cork Board - Aluminum Trim

Part No.	HxW	Ship Wt.	Price
312AA*	1 1/2'H x 2'W	6 lbs	\$43.22
312AB*	2'H x 3'W	12 lbs	\$76.37
312AC**	3'H x 4'W	24 lbs	\$136.42
312AD	4'H x 4'W	32 lbs	\$175.94
312AG	4'H x 6'W	48 lbs	\$254.77
312AH	4'H x 8'W	64 lbs	\$333.96

Please specify color when ordering:



Please refer to p. 2 for a description of symbols.

Vinyl Cork-Plate Tackboard with Standard Aluminum Trim

- » Fabric-backed vinyl over 1/4" cork and a lightweight substrate.
- » GREENGUARD Indoor Air Quality Certified® and GREENGUARD Children & Schools CertifiedSM.
- » Easy to clean. Treated to resist the growth of odor- and stain-causing microbes.
- » Made in the USA. TAA compliant. 10 year guarantee.

Vinyl Cork-Plate Board - Aluminum Trim

Part No.	HxW	Ship Wt.	Price
313AA*	1 1/2'H x 2'W	8 lbs	\$54.09
313AB*	2'H x 3'W	17 lbs	\$98.16
313AC**	3'H x 4'W	33 lbs	\$180.63
313AD	4'H x 4'W	44 lbs	\$235.10
313AG	4'H x 6'W	66 lbs	\$343.77
313AH	4'H x 8'W	88 lbs	\$452.16

Please specify color when ordering:





A Pacific Blue

Available as a ASTM E84 Class A Fire Rated Board with 1/2" fire and smoke rated gypsum board core. Call for details and pricing.



Please refer to p. 2 for a description of symbols.



Please specify color when ordering:



Cotton (46) Gray (44) Pac. Blue (47)

Vin-Tak in stock in Cotton, Gray, and Pacific Blue.

See page 220 for all color choices!

Board (right) shown in Champagne.



Vin-Tak Tackboard with Standard Aluminum Trim

- » Fabric-backed vinyl over lightweight substrate for an economical and attractive tackboard.
- » GREENGUARD Indoor Air Quality Certified® and GREENGUARD Children & Schools CertifiedSM.
- » Easy to clean. Treated to resist the growth of odor- and stain-causing microbes.
- » Board is available with fire rated gypsum, fire rated adhesive, and fire rated vinyl.
- » The ASTM E84 Class A fire rating is based on a rounded Flame Spread Index (FSI) of 20 and a rounded Smoke Developed Index (SDI) of 55. A full test report copy is available upon request.
- » Made in the USA. TAA compliant. 10 year guarantee.

Vin-Tak Tackboard - Aluminum Trim			
Part No.	HxW	Ship Wt.	Price
311AA*	1 1/2'H x 2'W	4 lbs	\$33.63
311AB*	2'H x 3'W	7 lbs	\$57.21
311AC**	3'H x 4'W	14 lbs	\$97.98
311AD	4'H x 4'W	20 lbs	\$130.89
311AE	3'H x 5'W	21 lbs	\$142.06
311AF	4'H x 5'W	28 lbs	\$151.51
311AG	4'H x 6'W	37 lbs	\$178.16
311AH	4'H x 8'W	49 lbs	\$232.67
311AK	4'H x 10'W	60 lbs	\$294.43
311AM	4'H x 12'W	79 lbs	\$348.81

Vin-Tak Board - Unframed			
Part No.	Item	Ship Wt.	Price
311X	Cut Edge / sq. ft.	1 1/2 lbs	\$5.05
314E	Wrapped Edge / sq. ft.	1 1/2 lbs	\$5.65

Vin-Tak Tackboard - Class A Fire Rated			
Part No.	HxW	Ship Wt.	Price
F311AA*	1 1/2'H x 2'W	4 lbs	Call
F311AB*	2'H x 3'W	7 lbs	Call
F311AC**	3'H x 4'W	14 lbs	Call
F311AD	4'H x 4'W	20 lbs	Call
F311AE	3'H x 5'W	21 lbs	Call
F311AF	4'H x 5'W	28 lbs	Call
F311AG	4'H x 6'W	37 lbs	Call
F311AH	4'H x 8'W	49 lbs	Call
F311AK	4'H x 10'W	60 lbs	Call
F311AM	4'H x 12'W	79 lbs	Call

Tackboards: Vinyl



Please refer to p. 2 for a description of symbols.

Pebbles Vinyl Tackboard with Standard Aluminum Trim

- » Pebbles Vinyl is fabric-backed and textured to hide pin holes. Featured in traditional aluminum trim.
- » GREENGUARD Indoor Air Quality Certified® and GREENGUARD Children & Schools CertifiedSM.
- » Treated to resist the growth of odor- and stain-causing microbes.
- » Made in the USA. TAA compliant. 10 year guarantee.



A Light Quarry

ⓐ Pebbles Vinyl Tackboard - Aluminum Trim

Part No.	Dimensions	Ship Wt.	Price
311AA-PV*	1 1/2'H x 2'W	4 lbs	\$40.44
311AB-PV*	2'H x 3'W	7 lbs	\$75.10
311AC-PV**	3'H x 4'W	14 lbs	\$116.71
311AD-PV	4'H x 4'W	20 lbs	\$156.03
311AF-PV	4'H x 5'W	21 lbs	\$190.69
311AG-PV	4'H x 6'W	37 lbs	\$217.19
311AH-PV	4'H x 8'W	49 lbs	\$258.85
311AK-PV	4'H x 10'W	60 lbs	\$312.91
311AM-PV	4'H x 12'W	79 lbs	\$367.40

Please specify color when ordering. Other colors available, see p. 220.

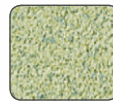

Celery

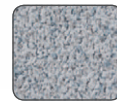

Country Stone



Dune

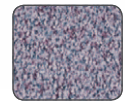

Plum

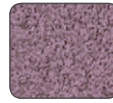

Claret



Cream

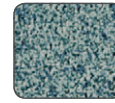

Hedgerow



Red Hot



Please refer to p. 2 for a description of symbols.

Clean-Tak Tackboard with Standard Aluminum Trim

- » Clean-Tak vinyl surface contains bacteria inhibitors to protect from microbial growth.
- » Third party tested to be a low VOC emission surface.
- » Contains a minimum of 20% post-consumer waste.
- » Durable and washable.
- » Made in the USA. TAA compliant. 10 year guarantee.

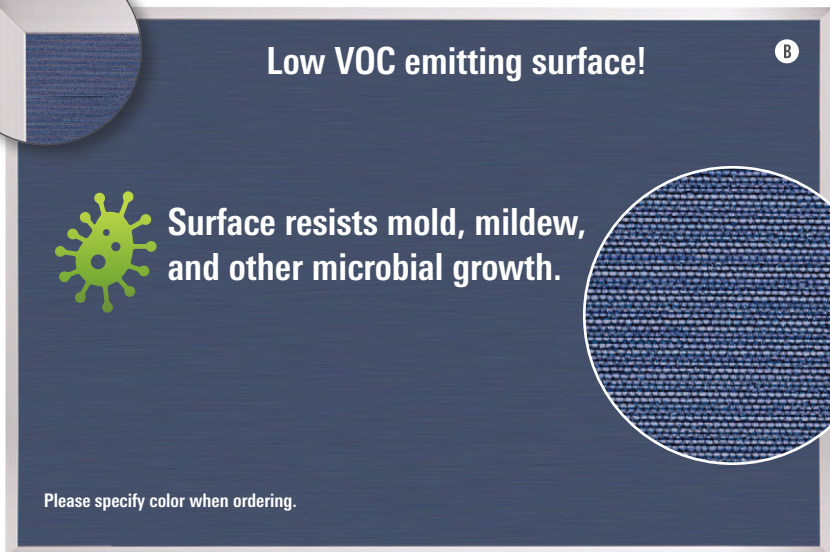
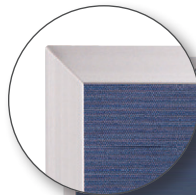

B



Surface resists mold, mildew, and other microbial growth.

Please specify color when ordering.

ⓑ Clean-Tak Tackboard - Aluminum Trim

Part No.	HxW	Ship Wt.	Price
319AB*	2'H x 3'W	7 lbs	\$72.49
319AC**	33 3/4"H x 4'W	14 lbs	\$115.29
319AG	4'H x 6'W	37 lbs	\$211.77
319AH	4'H x 8'W	49 lbs	\$284.94



Blue (102)



Gray (103)



Green (101)



Tan (100)



Please specify color when ordering. See color codes below.



Black (96)

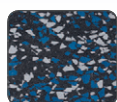

Blue (97)

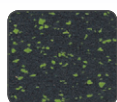

Green (104)



Red (99)

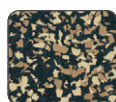

Tan (95)



Please refer to p. 2 for a description of symbols.

Rubber-Tak Tackboard with Standard Aluminum Trim

- » Rubber-Tak Tackboards are made with recycled rubber, providing superior resilience.
- » GREENGUARD Indoor Air Quality Certified® and GREENGUARD Children & Schools CertifiedSM.
- » Surface resists most chemicals, stain- and odor-causing microbes, is easy to clean, and is sound- and shock-absorbent.
- » Made in the USA. TAA compliant. 50 year guarantee.

ⓐ Rubber-Tak Tackboard - Aluminum Trim

Part No.	Dimensions	Ship Wt.	Price
321AA*	1 1/2'H x 2'W	8 lbs	\$40.44
321AB*	2'H x 3'W	17 lbs	\$75.10
321AC**	3'H x 4'W	33 lbs	\$116.71
321AD	4'H x 4'W	44 lbs	\$156.03
321AF	4'H x 5'W	55 lbs	\$190.69
321AG	4'H x 6'W	66 lbs	\$217.19
321AH	4'H x 8'W	88 lbs	\$258.85
321AK	4'H x 10'W	110 lbs	\$312.91
321AM	4'H x 12'W	132 lbs	\$367.40



ReTire rubber features speckles of color to create a unique and attractive surface.

Recycled Rubber!

ReTire surface is 100% recycled rubber! Eco-friendly, easy to clean, moisture and fade resistant!



Please refer to p. 2 for a description of symbols.

ReTire Recycled Rubber Tackboard with Standard Aluminum Trim

- » ReTire Board features a rubber surface that is 100% recycled.
- » The rubber content is 90% post consumer and 10% post-industrial.
- » Moisture and chemical resistance in a stain and fade resistant, washable surface.
- » Multi-colored, textured surface with unmatched durability.
- » Made in the USA. TAA compliant. 20 year guarantee.

ⓑ ReTire Rubber Tackboard - Aluminum Trim

Part No.	Dimensions	Ship Wt.	Price
320AA*	1 1/2'H x 2'W	8 lbs	\$39.36
320AB*	2'H x 3'W	17 lbs	\$59.00
320AC**	3'H x 4'W	33 lbs	\$95.00
320AD	4'H x 4'W	44 lbs	\$125.00
320AF	4'H x 5'W	55 lbs	\$145.00
320AG	4'H x 6'W	66 lbs	\$169.00
320AH	4'H x 8'W	88 lbs	\$219.00

Tackboards: Fabric



Crimson (58)

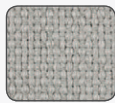

Granite (36)



Indigo (35)



Nutmeg (33)



Spruce (32)

Please specify color when ordering.

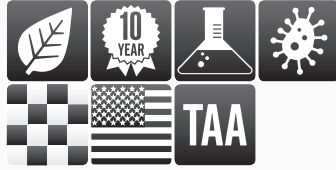

Please refer to p. 2 for a description of symbols.

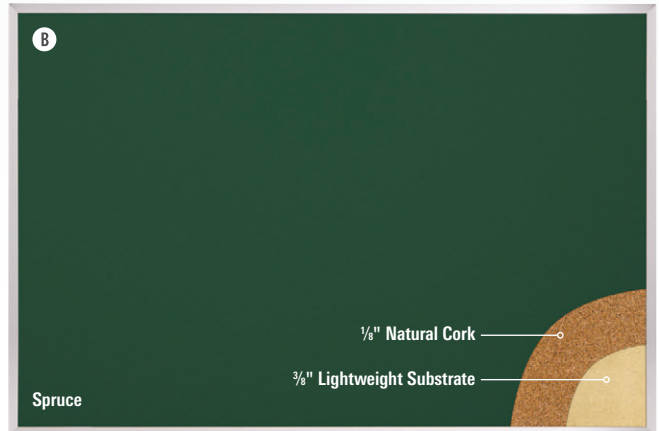
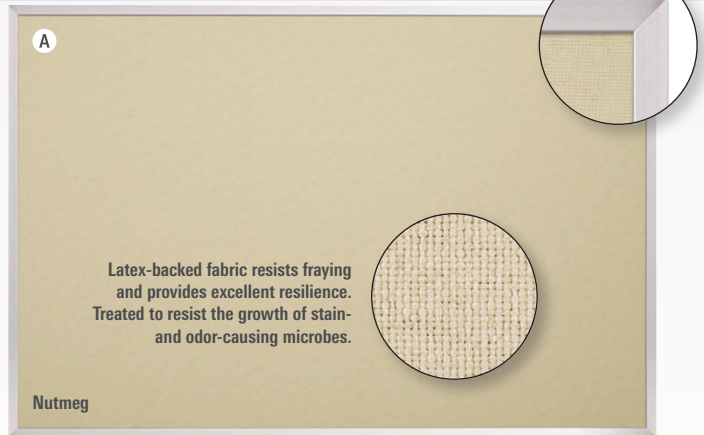

A Fab-Tak Tackboard with Standard Aluminum Trim

- » Fab-Tak Boards feature Polyolefin fabric with a lightweight tackable substrate.
- » Fabric is washable and unaffected by most common chemicals, salts, and cleansers.
- » Fabric treated to resist the growth of stain- and odor-causing microbes.
- » Made in the USA. TAA compliant. 10 year guarantee.

B Fabric Add-Cork Tackboard with Standard Aluminum Trim

- » Fabric Add-Cork Boards feature Polyolefin fabric with cork and a lightweight substrate.
- » Fabric is washable and unaffected by most common chemicals, salts, and cleansers.
- » Fabric treated to resist the growth of stain- and odor-causing microbes.
- » Made in the USA. TAA compliant. 10 year guarantee.

C Fabric Cork-Plate Tackboard with Standard Aluminum Trim

- » Fabric Cork-Plate Boards feature Polyolefin fabric with a cork and MDF substrate.
- » Fabric is washable and unaffected by most common chemicals, salts, and cleansers.
- » Fabric treated to resist the growth of stain- and odor-causing microbes.
- » Made in the USA. TAA compliant. 10 year guarantee.

A Fab-Tak Board - Aluminum Trim

Part No.	HxW	Ship Wt.	Price
331AA*	1 1/2'H x 2'W	4 lbs	\$41.45
331AB*	2'H x 3'W	7 lbs	\$68.35
331AC**	3'H x 4'W	14 lbs	\$119.81
331AD	4'H x 4'W	22 lbs	\$155.11
331AE	3'H x 5'W	21 lbs	\$182.17
331AF	4'H x 5'W	28 lbs	\$189.04
331AG	4'H x 6'W	37 lbs	\$226.23
331AH	4'H x 8'W	49 lbs	\$295.32
331AK	4'H x 10'W	60 lbs	\$390.08
331AM	4'H x 12'W	79 lbs	\$464.44

Fab-Tak Board - Unframed

Part No.	Item	Ship Wt.	Price
331X	Cut Edge / sq. ft.	1 1/2 lbs	\$6.77
334E	Wrapped Edge / sq. ft.	1 1/2 lbs	\$7.14

B Fabric Add-Cork Board - Aluminum Trim

Part No.	HxW	Ship Wt.	Price
332AA*	1 1/2'H x 2'W	6 lbs	\$51.33
332AB*	2'H x 3'W	12 lbs	\$91.88
332AC**	3'H x 4'W	24 lbs	\$172.01
332AD	4'H x 4'W	32 lbs	\$225.59
332AE	3'H x 5'W	30 lbs	\$267.40
332AF	4'H x 5'W	40 lbs	\$277.99
332AG	4'H x 6'W	48 lbs	\$329.99
332AH	4'H x 8'W	64 lbs	\$435.78
332AK	4'H x 10'W	80 lbs	\$547.06
332AM	4'H x 12'W	96 lbs	\$656.48

Vin-Tak Board - Unframed

Part No.	Item	Ship Wt.	Price
332X	Cut Edge / sq. ft.	1 1/2 lbs	\$10.01

C Fabric Cork-Plate Board - Aluminum Trim

Part No.	HxW	Ship Wt.	Price
333AA*	1 1/2'H x 2'W	8 lbs	\$60.60
333AB*	2'H x 3'W	17 lbs	\$111.05
333AC**	3'H x 4'W	33 lbs	\$210.06
333AD	4'H x 4'W	44 lbs	\$274.40
333AE	3'H x 5'W	42 lbs	\$329.99
333AF	4'H x 5'W	55 lbs	\$336.75
333AG	4'H x 6'W	66 lbs	\$404.61
333AH	4'H x 8'W	88 lbs	\$529.66
333AK	4'H x 10'W	110 lbs	\$682.51
333AM	4'H x 12'W	132 lbs	\$816.21
333AP	4'H x 16'W	176 lbs	\$1,085.61

Vinyl Cork-Plate Board - Unframed

Part No.	Item	Ship Wt.	Price
333X	Cut Edge / sq. ft.	1 1/2 lbs	\$13.79

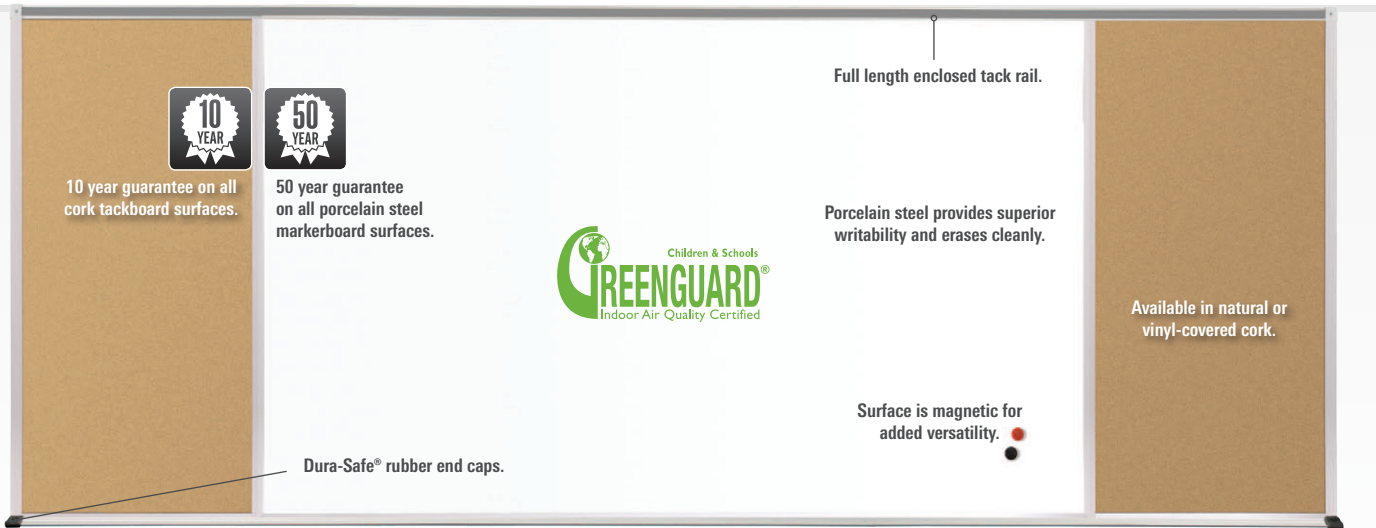

10 year guarantee on all cork tackboard surfaces.



50 year guarantee on all porcelain steel markerboard surfaces.



Full length enclosed tack rail.

Porcelain steel provides superior writability and erases cleanly.

Available in natural or vinyl-covered cork.

Surface is magnetic for added versatility.

Dura-Safe® rubber end caps.



Please refer to p. 2 for a description of symbols.

Combination Boards

- Combine markerboards and tackboards in one attractive and durable unit. Anodized aluminum trim on all surfaces.
- GREENGUARD Indoor Air Quality Certified® and GREENGUARD Children & Schools CertifiedSM. Certified boards incorporate material healthfulness, material reutilization, renewable energy use, water stewardship and social responsibility.
- All-in-one boards feature full length tackable map rail and full-length accessory tray with Dura-Safe® rubber end caps.
- Available in a variety of shape configurations.
- Porcelain steel - 50 year guarantee. Tackboard - 10 year guarantee.
- Made in the USA. TAA compliant.



Type "H" Combo Markerboard with Cork Tackboard

Part No.	Total	Writing	Tack	Ship Wt.	Price
406-90-PM-X2	4' x 6'	3' x 2'	4' x 2'	102 lbs	\$486.69
408-90-PM-X2	4' x 8'	3' x 4'	4' x 2'	136 lbs	\$605.71
410-90-PM-X2	4' x 10'	3' x 6'	4' x 2'	170 lbs	\$759.20
412-90-PM-X2	4' x 12'	3' x 8'	4' x 2'	214 lbs	\$921.78
416-90-PM-X2	4' x 16'	3' x 8'	4' x 4'	272 lbs	\$1,208.80

Type "H" Combo Chalkboard with Cork Tackboard

Part No.	Total	Writing	Tack	Ship Wt.	Price
406-90-PC-X2	4' x 6'	3' x 2'	4' x 2'	102 lbs	\$476.65
408-90-PC-X2	4' x 8'	3' x 4'	4' x 2'	136 lbs	\$600.11
410-90-PC-X2	4' x 10'	3' x 6'	4' x 2'	170 lbs	\$754.37
412-90-PC-X2	4' x 12'	3' x 8'	4' x 2'	214 lbs	\$912.53
416-90-PC-X2	4' x 16'	3' x 8'	4' x 4'	272 lbs	\$1,170.70

Available in a variety of shape configurations:

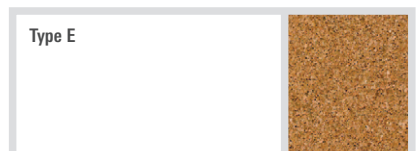
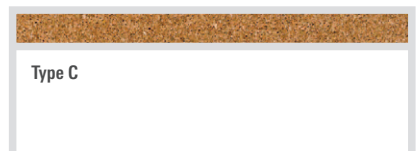
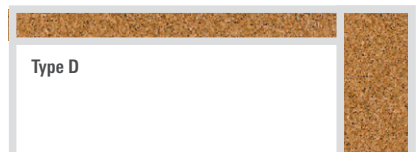
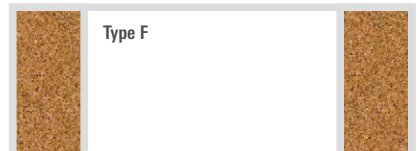
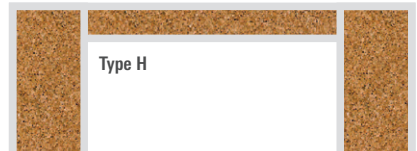

Type "F" Combo Markerboard with Cork Tackboard

Part No.	Total	Writing	Tack	Ship Wt.	Price
406-70-PM-X2	4' x 6'	4' x 2'	4' x 2'	102 lbs	\$486.83
408-70-PM-X2	4' x 8'	4' x 4'	4' x 2'	136 lbs	\$611.66
410-70-PM-X2	4' x 10'	4' x 6'	4' x 2'	170 lbs	\$749.28
412-70-PM-X2	4' x 12'	4' x 8'	4' x 2'	214 lbs	\$860.85
416-70-PM-X2	4' x 16'	4' x 12'	4' x 2'	272 lbs	\$1,147.40

Type "F" Combo Chalkboard with Cork Tackboard

Part No.	Total	Writing	Tack	Ship Wt.	Price
406-70-PC-X2	4' x 6'	4' x 2'	4' x 2'	102 lbs	\$476.52
408-70-PC-X2	4' x 8'	4' x 4'	4' x 2'	136 lbs	\$601.61
410-70-PC-X2	4' x 10'	4' x 6'	4' x 2'	170 lbs	\$733.77
412-70-PC-X2	4' x 12'	4' x 8'	4' x 2'	214 lbs	\$844.96
416-70-PC-X2	4' x 16'	4' x 12'	4' x 2'	272 lbs	\$1,178.77

Type "D" Combo Markerboard with Cork Tackboard

Part No.	Total	Writing	Tack	Ship Wt.	Price
406-40-PM-X2	4' x 6'	3' x 4'	4' x 2'	102 lbs	\$477.51
408-40-PM-X2	4' x 8'	3' x 6'	4' x 2'	136 lbs	\$618.23
410-40-PM-X2	4' x 10'	3' x 6'	4' x 2'	170 lbs	\$739.59
412-40-PM-X2	4' x 12'	3' x 8'	4' x 4'	214 lbs	\$900.18
416-40-PM-X2	4' x 16'	3' x 12'	4' x 4'	272 lbs	\$1,221.83

Type "D" Combo Chalkboard with Cork Tackboard

Part No.	Total	Writing	Tack	Ship Wt.	Price
406-40-PC-X2	4' x 6'	3' x 4'	4' x 2'	102 lbs	\$476.65
408-40-PC-X2	4' x 8'	3' x 6'	4' x 2'	136 lbs	\$612.40
410-40-PC-X2	4' x 10'	3' x 6'	4' x 2'	170 lbs	\$732.65
412-40-PC-X2	4' x 12'	3' x 8'	4' x 4'	214 lbs	\$842.47
416-40-PC-X2	4' x 16'	3' x 12'	4' x 4'	272 lbs	\$1,210.40

Type "C" Combo Markerboard with Cork Tackboard

Part No.	Total	Writing	Tack	Ship Wt.	Price
404-10-PM-X2	4' x 4'	3' x 2'	1' x 4'	68 lbs	\$340.76
406-10-PM-X2	4' x 6'	3' x 6'	1' x 6'	102 lbs	\$499.73
408-10-PM-X2	4' x 8'	3' x 8'	1' x 8'	136 lbs	\$660.93
410-10-PM-X2	4' x 10'	3' x 10'	1' x 10'	170 lbs	\$834.16
412-10-PM-X2	4' x 12'	3' x 12'	1' x 12'	214 lbs	\$991.40
416-10-PM-X2	4' x 16'	3' x 16'	1' x 16'	272 lbs	\$1,316.14

Type "C" Combo Chalkboard with Cork Tackboard

Part No.	Total	Writing	Tack	Ship Wt.	Price
404-10-PC-X2	4' x 4'	3' x 4'	1' x 4'	68 lbs	\$337.29
406-10-PC-X2	4' x 6'	3' x 6'	1' x 6'	102 lbs	\$494.64
408-10-PC-X2	4' x 8'	3' x 8'	1' x 8'	136 lbs	\$654.35
410-10-PC-X2	4' x 10'	3' x 10'	1' x 10'	170 lbs	\$826.46
412-10-PC-X2	4' x 12'	3' x 12'	1' x 12'	214 lbs	\$981.21
416-10-PC-X2	4' x 16'	3' x 16'	1' x 16'	272 lbs	\$1,308.28

Type "E" Combo Markerboard with Cork Tackboard

Part No.	Total	Writing	Tack	Ship Wt.	Price
404-60-PM-X2	4' x 4'	4' x 2'	4' x 2'	68 lbs	\$307.63
406-60-PM-X2	4' x 6'	4' x 4'	4' x 2'	102 lbs	\$486.69
408-60-PM-X2	4' x 8'	4' x 6'	4' x 2'	136 lbs	\$611.66
410-60-PM-X2	4' x 10'	4' x 6'	4' x 4'	170 lbs	\$749.16
412-60-PM-X2	4' x 12'	4' x 8'	4' x 4'	214 lbs	\$861.35
416-60-PM-X2	4' x 16'	4' x 12'	4' x 4'	272 lbs	\$1,204.71

Type "E" Combo Chalkboard with Cork Tackboard

Part No.	Total	Writing	Tack	Ship Wt.	Price
404-60-PC-X2	4' x 4'	4' x 2'	4' x 2'	68 lbs	\$302.30
406-60-PC-X2	4' x 6'	4' x 4'	4' x 2'	102 lbs	\$477.51
408-60-PC-X2	4' x 8'	4' x 6'	4' x 2'	136 lbs	\$601.06
410-60-PC-X2	4' x 10'	4' x 6'	4' x 4'	170 lbs	\$733.52
412-60-PC-X2	4' x 12'	4' x 8'	4' x 4'	214 lbs	\$845.21
416-60-PC-X2	4' x 16'	4' x 12'	4' x 4'	272 lbs	\$1,180.51

Combination Boards





10 year guarantee on all cork tackboard surfaces.

50 year guarantee on all porcelain steel markerboard surfaces.



Please refer to p. 2 for a description of symbols.

Please specify color when ordering.
See color codes on p. XX.



Children & Schools
GREENGUARD
Indoor Air Quality Certified



Combo-Rite Boards

- » Combine markerboards and tackboards in one attractive and modular unit.
- » GREENGUARD Indoor Air Quality Certified® and GREENGUARD Children & Schools CertifiedSM.
- » Surfaces can be changed or replaced when you need them, saving time and money.
- » Anodized aluminum trim features easy to use H-channels to attach surfaces together.
- » Writing surfaces include a full length map rail and accessory tray with Dura-Safe® rubber end caps.
- » Available in a variety of shape configurations. Each ships within 7 days!
- » Porcelain steel markerboard is guaranteed for 50 years. Tackboards are guaranteed for 10 years.
- » Made in the USA. TAA compliant.

Available in a variety of shape configurations:

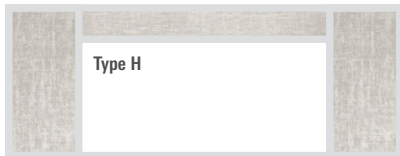

Type "H" Combo-Rite Markerboard with Vinyl Tackboard						
Part No.	Total	Writing	Tack	Ship Wt.	Price	
508-9C-PM-X2	5' x 8'	3' x 4'	4' x 2'	136 lbs	\$590.10	
510-9C-PM-X2	5' x 10'	3' x 6'	4' x 2'	170 lbs	\$722.33	
512-9C-PM-X2	5' x 12'	3' x 8'	4' x 2'	214 lbs	\$877.51	
516-9C-PM-X2	5' x 16'	3' x 8'	4' x 4'	272 lbs	\$1,150.70	

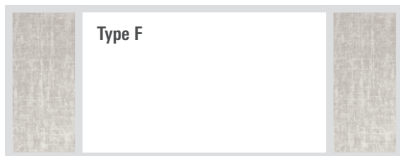

Type "F" Combo-Rite Markerboard with Vinyl Tackboard						
Part No.	Total	Writing	Tack	Ship Wt.	Price	
408-7C-PM-X2	4' x 8'	4' x 4'	4' x 2'	136 lbs	\$712.50	
410-7C-PM-X2	4' x 10'	4' x 6'	4' x 2'	170 lbs	\$819.59	
412-7C-PM-X2	4' x 12'	4' x 8'	4' x 2'	214 lbs	\$1,204.71	
416-7C-PM-X2	4' x 16'	4' x 8'	4' x 4'	272 lbs	\$1,146.33	



Type "E" Combo-Rite Markerboard with Vinyl Tackboard						
Part No.	Total	Writing	Tack	Ship Wt.	Price	
408-6C-PM-X2	4' x 8'	4' x 6'	4' x 2'	136 lbs	\$582.45	
410-6C-PM-X2	4' x 10'	4' x 6'	4' x 4'	170 lbs	\$700.69	
412-6C-PM-X2	4' x 12'	4' x 8'	4' x 4'	214 lbs	\$819.59	
416-6C-PM-X2	4' x 16'	4' x 12'	4' x 4'	272 lbs	\$1,146.33	

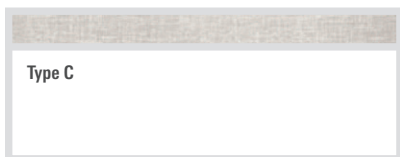

Type "C" Combo-Rite Markerboard with Vinyl Tackboard						
Part No.	Total	Writing	Tack	Ship Wt.	Price	
506-1C-PM-X2	5' x 6'	4' x 6'	1' x 6'	102 lbs	\$475.36	
508-1C-PM-X2	5' x 8'	4' x 8'	1' x 8'	136 lbs	\$629.44	
510-1C-PM-X2	5' x 10'	4' x 10'	1' x 10'	170 lbs	\$793.36	
512-1C-PM-X2	5' x 12'	4' x 12'	1' x 12'	214 lbs	\$944.16	
516-1C-PM-X2	5' x 16'	4' x 16'	1' x 16'	272 lbs	\$1,253.42	



Type "D" Combo-Rite Markerboard with Vinyl Tackboard						
Part No.	Total	Writing	Tack	Ship Wt.	Price	
506-4C-PM-X2	5' x 6'	3' x 4'	4' x 2'	102 lbs	\$454.60	
508-4C-PM-X2	5' x 8'	3' x 6'	4' x 2'	136 lbs	\$587.92	
510-4C-PM-X2	5' x 10'	3' x 6'	4' x 4'	170 lbs	\$703.76	
512-4C-PM-X2	5' x 12'	3' x 8'	4' x 4'	214 lbs	\$856.75	
516-4C-PM-X2	5' x 16'	3' x 12'	4' x 4'	272 lbs	\$1,162.72	



Mount porcelain board to wall. Attach an H-channel to one side. Slip the header panel into place.



Attach the second H-channel to the other side of the porcelain board directly over the frame.



Framed tackboard slides easily into the H-channel for a simple and secure mount.



Please refer to p. 2 for a description of symbols.

Adjustable Modular Boards

- » Adjustable Modular Boards let you to mix and match different surfaces to fit your needs.
- » Available in dry erase markerboard, chalkboard, or tackboard surfaces.
- » Writing surfaces include a tackable map rail and tray with Dura-Safe® rubber end caps.
- » Panels are 4'H and either 4' or 8' wide and fit into brackets that attach to 6'H standards
- » Height adjustable in 2" increments.

Choose from a variety of panel options including markerboards, chalkboards, graphic surfaces, or tackboards. Call for pricing.



Writing surfaces include full-length tackable map rail.

OCCAM'S RAZOR:

- EXPLANATION OF ANY PHENOMENON SHOULD MAKE AS FEW ASSUMPTIONS AS POSSIBLE - ALL THINGS BEING EQUAL THE SIMPLEST EXPLANATION SHOULD...

Mix and match board surfaces for custom combinations to fit your needs.

SCIENTIFIC PROCESS:

- OBSERVATION
- DESCRIPTION
- PREDICTION/HYPOTHESIS
- CONTROL
- IDENTIFICATION OF CAUSES/ EXPERIMENTATION

Writing surfaces include accessory tray with Dura-Safe® rubber end caps.



TAA

Please refer to p. 2 for a description of symbols.

Horizontal Sliding Boards

- » Horizontal Sliding Boards save wall space and add functional board surface.
- » Customizable boards feature panels that slide on a smooth track system.
- » Lightweight core material and precise alignment of the tracks ensure easy operation.
- » Choose from two-, three-, or four-track systems. Panels are 4'H and from 6' to 20'W.
- » Available with porcelain steel markerboard or chalkboard, or any tackable surface.
- » Framed with heavy gauge anodized aluminum tubing. Map rail and accessory tray included.
- » Made in the USA. TAA compliant.

Durable ball bearing rollers allow for an optimal smooth glide along their track.

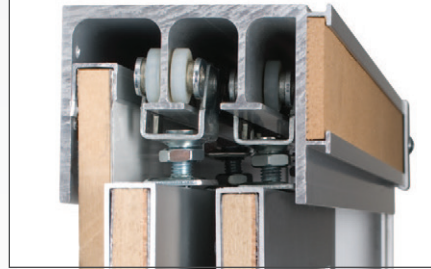

Horizontal Sliding Board

Part No.	Item	H x W	Ship Wt.	Price
822HH	2 Track/2 Panel	4' x 8'	350 lbs	\$2,098.30
822HM	2 Track/2 Panel	4' x 12'	510 lbs	\$2,678.90
824HM	4 Track/4 Panel	4' x 12'	620 lbs	\$4,038.36

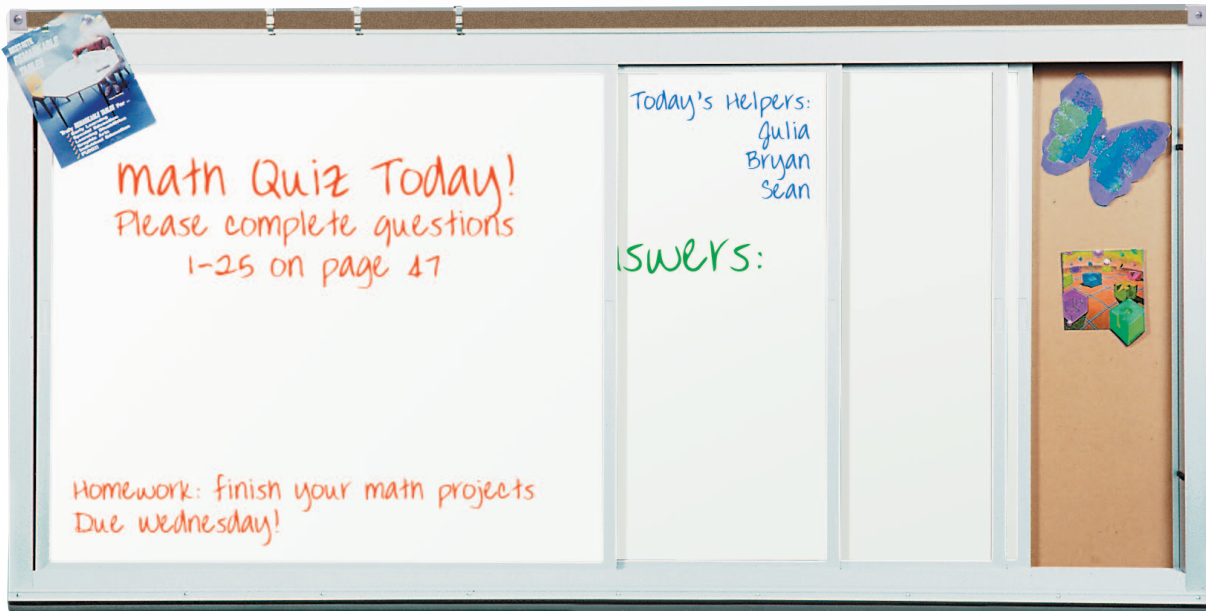



Give your board new life and functionality with our Retro-Finish Panel.



Surface is magnetic for added versatility.



Scan this QR code to watch our board resurfacing online video.

Pre-drilled holes ensure easy installation on top of existing surface.



Easy installation. Just a few screws and you're done!



New Projection Surface cuts glare and enhances projection clarity!



Please refer to p. 2 for a description of symbols.

Retro-Finish Panels

- » Retro-Finish Panels make short work of resurfacing any old chalkboard or markerboard.
- » No need to remove existing board. Simply screw Retro-Finish Panel into old board.
- » Factory framed panels come with pre-drilled holes make mounting easy.
- » Surface is durable porcelain steel for a superior board. Available in an off-white or a matte gray for enhanced projection clarity with minimized glare.
- » Custom sizes available.
- » Made in the USA. TAA compliant. 50 year guarantee.

Part No.	Description	H x W	Ship Wt.	Price
2R2A	Retro-Finish Panel - Off-White	4' x 4', 6', 8', 10', or 12'	3 1/2 lbs/sq ft	\$12.13/sq. ft
4R4A	Retro-Finish Panel - Projection Gray	4' x 4', 6', 8', 10', or 12'	3 1/2 lbs/sq ft	\$13.98/sq. ft



Please refer to p. 2 for a description of symbols.

Porcelain Steel Panels

- » Porcelain Steel Panels turn any existing board or surface into a brand new markerboard.
- » Provides exceptional writability, erasability, and color contrast.
- » Layer of porcelain steel adhered to MDF for a total 1/4" panel thickness.
- » Panel roller and adhesive available for easy installation.
- » Made in the USA. TAA compliant. 50 year guarantee.

Adhesive tubes and panel roller available for easy installation.



Porcelain Steel Panels

Part No.	Dimensions	Ship Wt.	Price
2H2X	4'H x 4', 6', 8', 10', or 12'W	4 1/2 lbs/sq. ft.	\$11.52

Panel Adhesive

Part No.	Dimensions	Ship Wt.	Price
531*	4 tubes	12 lbs	\$42.35

Panel Roller

Part No.	Dimensions	Ship Wt.	Price
545*		2 lbs	\$90.87

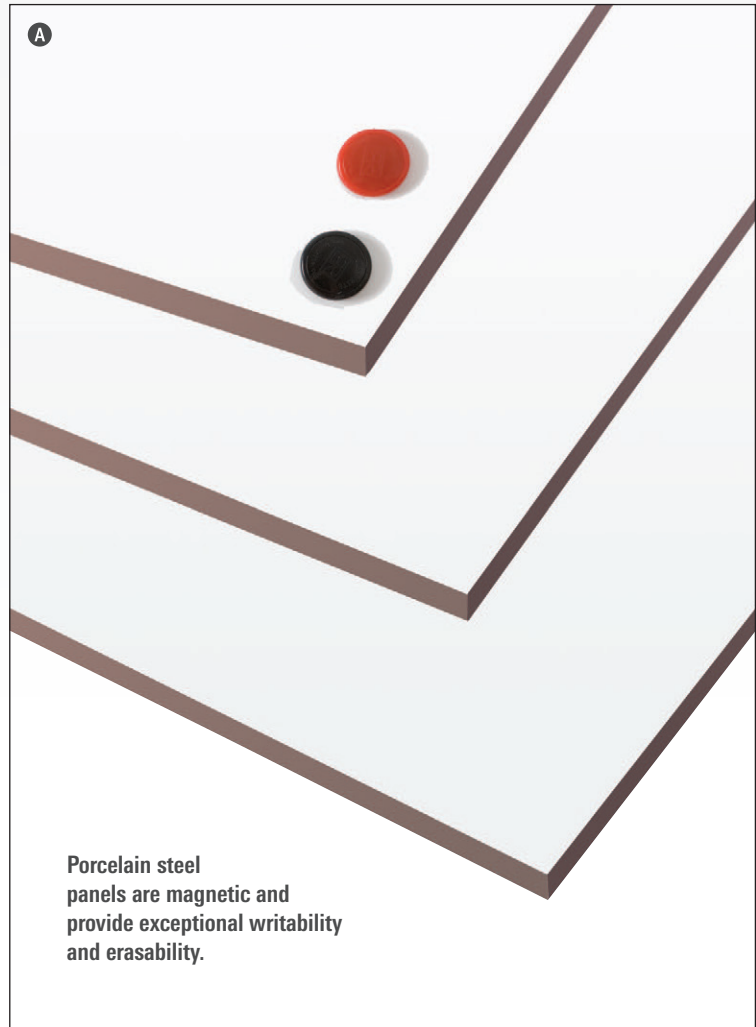

Please refer to p. 2 for a description of symbols.

Porcelain Steel Self-Adhesive Skins

- » Porcelain Steel Self-Adhesive Skins make resurfacing a board easy, without a mess or fumes.
- » Simply peel the protective sheet from the back, align, and mount onto a pre-existing board.
- » High quality skins are made from 24-gauge steel in either markerboard or chalkboard.
- » Cover bar available to hide seams.
- » Made in the USA. TAA compliant. 50 year guarantee.



See product video online!
youtube.com/moorecoinc



Simple installation:



Measure old surface accurately.



Clean old surface and test fit new skin.



Peel backing. Align and apply.



Roll entire surface to ensure adhesion.

Porcelain Steel Self-Adhesive Skins

Part No.	Item	H x W	Ship Wt.	Price
208S	Skins	4' x 4'-12'	3 1/2 lbs/sq. ft.	\$11.64/sq. ft.
80-TM	Cover Bar	per linear ft	1 lb/lin.ft	\$6.94/lin. ft.



Please refer to p. 2 for a description of symbols.

Sharewall™

- » Think outside the frame with Sharewall™, the surface that does it all! Mounts in minutes as a virtually seamless whiteboard wall, ideal for meetings, training, and interoffice communication.
- » Made from porcelain coated steel alloy, Sharewall™ is engineered with a high aluminum content for flexibility, making it ideal for curved walls or installation on pillars. Surface is also magnetic for added utility!
- » When unrolled, the lightweight surface lays flat and stays flat, so that adhesive application and board installation is a snap.
- » Surfaces butt together for almost invisible seams, and can be applied quickly and easily over entire walls in meeting rooms, conference rooms, training rooms, or any community areas. No special tools or skills needed!
- » Available in glossy off-white or matte off-white for enhanced projection clarity with minimized glare. Matte gray projection surface coming soon. Please specify surface when ordering.
- » Sharewall™ ships rolled, and 4'H x 8'W will ship UPS to save you money.
- » 50 year guarantee. TAA compliant.

● Sharewall™ Panels

Part No.	Dimensions	Ship Wt.	Price
■ 208JX-NT	4'H x 8', 10', 12', or 16'W	2 lbs/sq ft	\$10.45/sq ft
■ 535*	Panel Adhesive (1 tube covers 16 sq ft)	3 lbs	\$18.19/tube



Please refer to p. 2 for a description of symbols.

New-Rite® Replacement Vinyl

- » New-Rite® replacement vinyl is the easiest way to resurface an old board.
- » Quality smooth vinyl dry erase surface provides excellent writability and erasability.
- » Will allow magnets if applied to an existing magnetic surface.
- » Easy to apply. Available in 4'H rolls that can be cut to fit any surface.
- » Made in the USA. TAA compliant. 10 year guarantee.

● New-Rite® Replacement Vinyl

Part No.	HxW	Ship Wt.	Price
■ 214H*	4'H x 8'W	9 lbs	\$273.37
■ 214K*	4'H x 10'W	10 lbs	\$341.14
■ 214M*	4'H x 12'W	11 lbs	\$409.37
■ 214*	4'H x 100'W	54 lbs	\$3,206.40

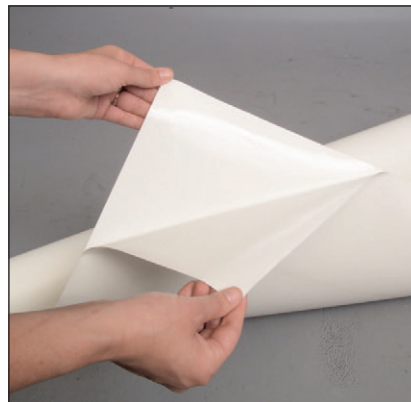

The easiest way to resurface an old board!

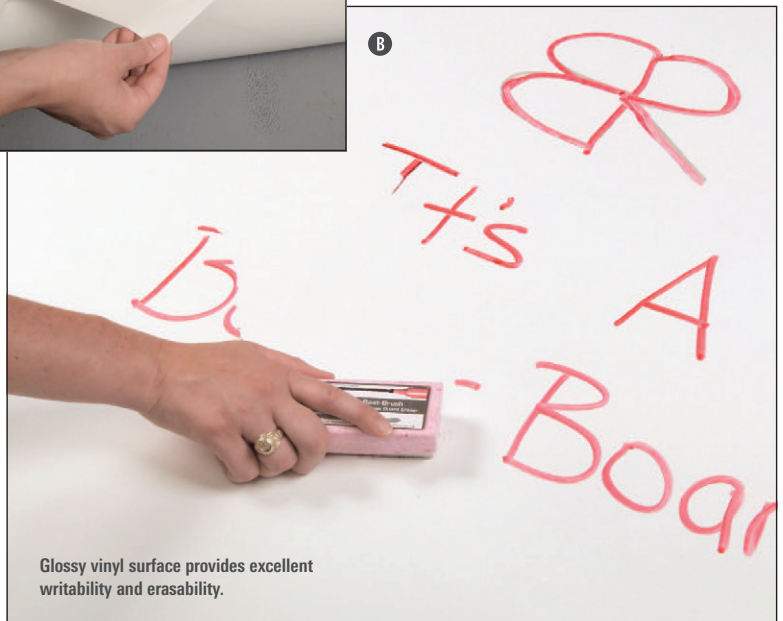

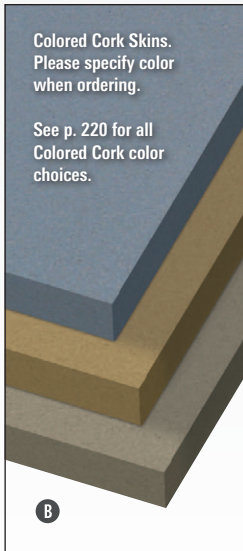

Simple installation:



Remove protective backing.



Align, apply, and roll down.



Please refer to p. 2 for a description of symbols.

Natural & Colored Cork Skins

- » Easily replace or renew any surface with Natural Cork Skins or Colored Cork Skins.
- » Self-adhesive skins apply easily to any board or wall surface, creating a new tack surface.
- » Cork surfaces are eco-friendly and make excellent tack surfaces.
- » Provides sound- and shock-absorbency.
- » Made in the USA. TAA compliant. 10 year guarantee.

Ⓐ Natural Cork Skins

Part No.	Dimensions	Ship Wt.	Price
308J	4'H x 4', 6', 8', 10', or 12'W	1/2 lbs./sq. ft.	\$7.87

Ⓑ Colored Cork Skins

Part No.	Dimensions	Ship Wt.	Price
325J	4'H x 4', 6', 8', 10', or 12'W	1 lb./sq. ft.	\$13.99



Natural Add-Cork Panels



Natural Cork-Plate Panels



Colored Cork Panels



Please refer to p. 2 for a description of symbols.

Natural & Colored Cork Panels

- » Natural cork panels available in two surfaces: Add-Cork and Cork-Plate.
- » Add-Cork features a 1/8" layer of natural cork bonded to a 3/8" layer of durable substrate.
- » Cork-Plate features a 1/4" layer of natural cork bonded to a 1/4" durable substrate.
- » 1/8" or 1/4" natural cork material also available in rolls. Call for information.
- » Colored Cork surface features 1/4" Forbo® bonded to a 1/4" durable substrate for superior strength and moisture resistance.
- » Made with natural linseed oil, granulated cork, rosin binders, and dry pigments.
- » Self-sanitizing quality inhibits contaminants.
- » Provides sound- and shock-absorbency. Durable and self-healing.
- » Made in the USA. TAA compliant. 10 year guarantee on all panels.



Vin-Tak Panels w/ wrapped edge

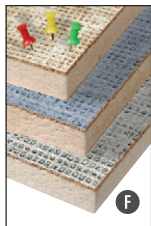

Vinyl Add-Cork Panels

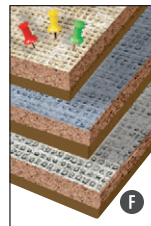

Vinyl Cork-Plate Panels

Vinyl & Fabric Covered Panels

- » Vinyl covered panels available in three surfaces: Vin-Tak, Vinyl Add-Cork and Vinyl Cork-Plate.
- » Vin-Tak features a vinyl surface laminated to a 7/16" insulation board substrate.
- » Fabric covered panels available in three surfaces: Fab-Tak, Fabric Add-Cork and Fabric Cork-Plate.
- » Fab-Tak features a fabric surface laminated to a 7/16" insulation board substrate.
- » Add-Cork panels feature vinyl or fabric over a 1/8" layer of natural cork bonded to a 3/8" layer of insulation board.
- » Cork-Plate panels feature vinyl or fabric over a 1/4" layer of natural cork bonded to a 1/4" durable substrate.
- » All panels priced and weighted per square foot.



Fab-Tak Panels w/ wrapped edge



Fabric Add-Cork Panels

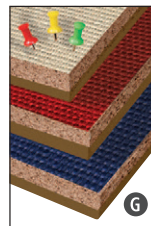

Fabric Cork-Plate Panels

Please specify color when ordering.

See p. 220 for all vinyl and fabric color choices.

Ⓐ Vinyl Covered Panels (per sq. ft.)

Part No.	Item	Ship Wt.	Price
311X	Vin-Tak Cut Edge	1 1/2 lbs	\$5.05
314E	Vin-Tak Wrapped Edge	1 1/2 lbs	\$5.65
312X	Vinyl Add-Cork	1 1/2 lbs	\$7.75
313X	Vinyl Cork-Plate	1 1/2 lbs	\$7.75

Ⓑ Natural Add-Cork Panels

Part No.	Item	H x W	Ship Wt.	Price
302XG	Add-Cork	4'H x 6'W	36 lbs	\$115.50
302XH	Add-Cork	4'H x 8'W	48 lbs	\$154.00
302XK	Add-Cork	4'H x 10'W	60 lbs	\$192.50
302XM	Add-Cork	4'H x 12'W	72 lbs	\$231.00

Ⓒ Natural Cork-Plate Panels

Part No.	Item	H x W	Ship Wt.	Price
303X	Cork-Plate	per sq. ft.	1 1/2 lbs	\$9.49

Ⓓ Colored Cork Panels

Part No.	H x W	Ship Wt.	Price
322X	per square foot	2 1/2 lbs	\$15.30

Ⓔ Fabric Covered Panels (per sq. ft.)

Part No.	Item	Ship Wt.	Price
331X	Fab-Tak Cut Edge	1 1/2 lbs	\$6.77
334E	Fab-Tak Wrapped Edge	1 1/2 lbs	\$7.14
332X	Fabric Add-Cork	1 1/2 lbs	\$10.01
333X	Fabric Cork-Plate	1 1/2 lbs	\$13.79



Please refer to p. 2 for a description of symbols.

Quest Star-Based Easel

- » The mobile Quest Star-Based Easel offers multi-faceted functionality. Use this easel as either a dry erase surface, a flipchart pad holder, or to post displays for presentations.
- » This sleek, sturdy easel offers a magnetic dry erase surface and a simple steel pad clamp to hold any standard size flipchart pad.
- » The 5-caster star base is height adjustable offering a range from 61 1/4" to 78" in height.
- » Writing surface usable area: 40" x 25 1/2".

A Quest Star-Based Easel			
Part No.	H x W	Ship Wt.	Price
37181	61 1/4" - 78"H x 27 3/4"W x 29"D	40 lbs	\$358.40



● Surface is magnetic for added versatility.

61 1/4"
to
78"

Steel pad clamp for flipcharts.



Built-in accessory tray.



Please refer to p. 2 for a description of symbols.

The Wheasel®

- » The Wheasel® is a double sided mobile easel ideal for any environment.
- » Available in framed and magnetic porcelain steel or unframed melamine.
- » Adjusts in height to 59 ½" or 65" high.
- » Lower storage tray and locking 2" casters included.
- » Accessory tray and flip chart hooks on each side.
- » Optional Wheasel® Pocket available. Attaches to side of easel.

A Wheasel®				
Part No.	Surface	Dimensions	Ship Wt.	Price
770**	Porcelain	65"H x 28 ¾"W x 27"D	61 lbs	\$498.53
759**	Melamine	65"H x 28 ¾"W x 27"D	51 lbs	\$324.69
B Wheasel® Pocket				
Part No.	Description	Ship Wt.	Price	
960*	Wheasel® Pocket	2 lbs	\$14.32	





Melamine



Please refer to p. 2 for a description of symbols.



Available with a magnetic porcelain steel surface.



Please refer to p. 2 for a description of symbols.



Flip chart hooks included.

Double sided melamine dry erase markerboard surfaces.

Middle storage shelf included.

Optional lower storage shelf.

Storage Wheasel®

- » The Storage Wheasel® includes four spacious storage tubs. Optional middle rack available to hold two additional tubs.
- » Choose from unframed melamine or framed and magnetic porcelain steel surface.
- » Porcelain steel surface doubles as a magnetic bulletin board.

A Storage Wheasel®

Part No.	Surface / Item	Dimensions	Ship Wt.	Price
762**	Melamine	58 1/2"H x 28 1/2"W x 29"D	54 lbs	\$278.77
763**	Porcelain Steel	58 1/2"H x 28 1/2"W x 29"D	55 lbs	\$358.76

B Optional Middle Rack

Part No.	Surface / Item	Ship Wt.	Price
764*	Optional Middle Rack	8 lbs	\$73.98

C Wheasel® Pocket

Part No.	Surface / Item	Ship Wt.	Price
960*	Wheasel® Pocket	2 lbs	\$14.32

Folding Wheasel®

- » The Folding Wheasel® is a mobile and versatile double-sided easel.
- » Two melamine surfaces, with two flip chart hooks and accessory tray on each side.
- » Height adjustable in two positions: 58 1/2" or 65",
- » Middle shelf provides storage space. Optional bottom mount tray is available.
- » Frame folds for storage and includes 2" casters (two locking).

D Folding Wheasel®

Part No.	Surface / Item	Dimensions	Ship Wt.	Price
778**	Folding Wheasel®	65"H x 28 3/4"W x 28 1/2"D	52 lbs	\$326.10

E Optional Tray

Part No.	Surface / Item	Dimensions	Ship Wt.	Price
779*	Optional Tray	28 3/4"W x 28 1/2"D	8 lbs	\$29.61



Please refer to p. 2 for a description of symbols.



Please refer to p. 2 for a description of symbols.

Eco Wheasel®

- » The Eco Wheasel® is a double-sided easel with lightweight melamine dry erase surfaces.
- » Surfaces measure 23"H x 28 3/4"W.
- » Includes middle tray. Bottom tray is available.
- » White powder-coated steel frame folds for storage and includes 2" locking casters.

G Eco Wheasel®

Part No.	Dimensions	Ship Wt.	Price
786**	58"H x 29 3/4"W x 28 3/4"D	35 lbs	\$207.57

H Optional Bottom Tray

Part No.	Dimensions	Ship Wt.	Price
786-01*	23 1/2"W x 28 3/4"D	7 lbs	\$23.18



Lightweight and economical melamine surfaces.

Mini Wheasel®

- » The Mini Wheasel® features economical melamine.
- » Frame is black powder-coated steel with 2" casters.

F Mini Wheasel®

Part No.	Dimensions	Ship Wt.	Price
774*	60"H x 23 1/2"W x 24"D	21 lbs	\$177.03

Easels



Please refer to p. 2 for a description of symbols.

Nest Easel

- » Nest Easel comes in either silver or black powder-coated steel.
- » Available with porcelain steel or melamine surfaces.
- » Height adjustable easel includes accessory trays and flip chart hooks.
- » Perforated storage box is also height adjustable.
- » Base includes 2" locking casters and is designed to allow nesting for compact storage.

Choose porcelain steel **A** or melamine **B** markerboard surface.

Porcelain steel is magnetic and resistant to most chemicals.



A Nest Easel - Porcelain Steel

Part No.	Color	Dimensions	Ship Wt.	Price
785P*	Silver	72"H x 31 1/2"W x 24"D	69 lbs	\$525.46
781P*	Black	72"H x 31 1/2"W x 24"D	69 lbs	\$525.46

B Nest Easel - Dura-Rite®

Part No.	Color	Dimensions	Ship Wt.	Price
785*	Silver	72"H x 31 1/2"W x 24"D	58 lbs	\$339.56
781*	Black	72"H x 31 1/2"W x 24"D	58 lbs	\$339.56



Please refer to p. 2 for a description of symbols.

Wood Nest Easel

- » The Wood Nest Easel comes in either oak or mahogany finished solid wood trim.
- » Available with a variety of dry erase surfaces. Surface measures 39 1/2"H x 27 1/4"W.
- » Height adjustable easel includes accessory trays and flip chart pegs.
- » Base includes 3" locking casters and is designed to allow nesting for compact storage.

Flip chart pegs included on both sides.

Accessory tray on both sides.



A Wood Nest Easel - Porcelain Steel

Part No.	Color	Dimensions	Ship Wt.	Price
790P**	Mahogany	72"H x 31 1/2"W x 24"D	60 lbs	\$589.95
790P-OAK**	Oak	72"H x 31 1/2"W x 24"D	60 lbs	\$589.95

B Wood Nest Easel - Melamine

Part No.	Color	Dimensions	Ship Wt.	Price
790**	Mahogany	72"H x 31 1/2"W x 24"D	56 lbs	\$455.93
790-OAK**	Oak	72"H x 31 1/2"W x 24"D	56 lbs	\$455.93



Please refer to p. 2 for a description of symbols.

Spinner Easel

- » The Spinner Easel has a double sided surface that rotates 360° on a vertical axis.
- » Markerboard surface doubles as a magnetic bulletin board.
- » Height adjustable from 40 1/2" for tabletop use to 69" for floor use.
- » Cushioned handle makes transport easy.
- » Easel folds and legs telescope for compact storage. Carrying bag included.
- » TAA compliant.

❶ Spinner Easel				
Part No.	Item	Dimensions	Ship Wt.	Price
■ 799**	Spinner Easel	69"H x 27"W x 27 1/2"D	37 lbs	\$273.19



Please refer to p. 2 for a description of symbols.

Convertible Easel

- » Get three easels in one with the versatile Convertible Easel.
- » Use as a floor easel, as a tabletop easel, or as a wall mounted dry erase board.
- » Adjusts in height from 42" to 72" in 6" increments.
- » Durable magnetic dry erase surface.
- » Blow mold plastic frame includes full length accessory tray. Powder-coated steel legs.

❷ Convertible Easel				
Part No.	Item	Dimensions	Ship Wt.	Price
■ 826*	Convertible Easel	75"H x 36 1/2"W x 21 1/2"D	30 lbs	\$290.66

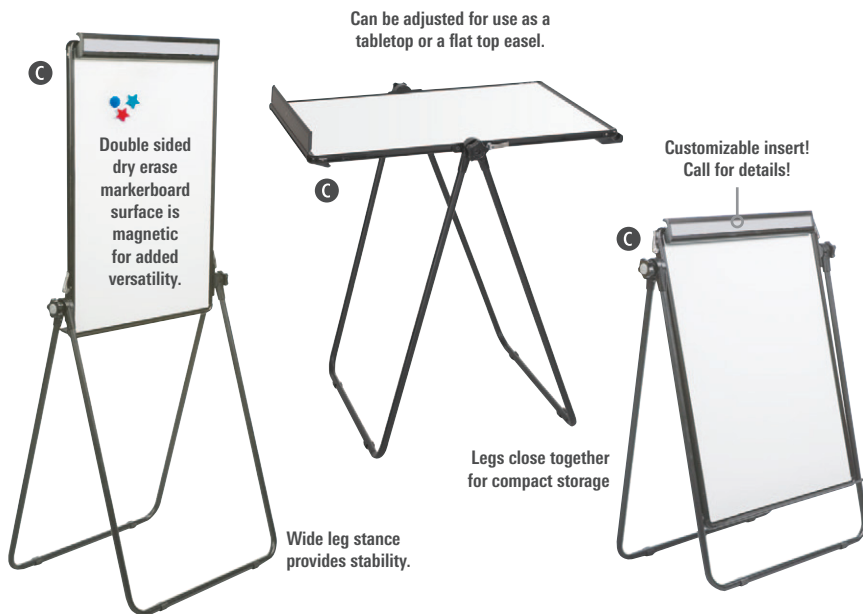

Please refer to p. 2 for a description of symbols.

Mega Easel

- » The versatile Mega Easel is attractive and customizable for a variety of uses.
- » Adjustable from tabletop to floor height (up to 70").
- » Can also be set up as a flat top table easel for group projects.
- » Double-sided magnetic dry erase surfaces double.
- » One side includes a spring-loaded chart holder with a customizable insert.
- » Folds flat for compact storage.

❸ Mega Easel				
Part No.	Dimensions	Ship Wt.	Price	
■ 820**	70"H x 26"W	28 lbs	\$264.24	



Please refer to p. 2 for a description of symbols.

Ideal Easel

- » The Ideal Easel adds a stylish element to any boardroom, meeting room, or classroom.
- » Easel can be used either on the tabletop (at 42" high) or on the floor (at 72" high).
- » Dry erase writing surface measures 35 1/2"H x 26"W.
- » Wooden accessory tray is included, along with flip chart rings.
- » Folds for compact storage.

Ideal Easel		Dimensions	Ship Wt.	Price
Part No.	Item			
1000*	Ideal Easel	42" - 72"H x 26"W	18 lbs	\$166.67



Please refer to p. 2 for a description of symbols.

Wood Presentation Easel

- » Wood Presentation Easel features a magnetic dry erase markerboard surface.
- » Solid wood frame is available in either natural oak or mahogany finish.
- » Adjusts in height to either 60" or 69". Folds flat for storage.

Wood Presentation Easel		Dimensions	Ship Wt.	Price
Part No.	Item			
745*	Natural Oak	69"H x 30"W x 31 1/2"D	38 lbs	\$199.00
745M*	Mahogany	69"H x 30"W x 31 1/2"D	38 lbs	\$199.00



Please refer to p. 2 for a description of symbols.

Nester Reversible Board

- » Mobile boards are available in a variety of surface combinations.
- » Surface (43"H x 29 3/8"W) rotates 360° on a pivot hinge and locks into place.
- » Two tier accessory tray included. Flip chart hooks included on dry erase surfaces.
- » Black powder-coated steel frame includes 3" casters (two locking) and a base designed to allow units to nest for compact storage.

A Nester Reversible Board					
Part No.	Surface	Dimensions	Ship Wt.	Price	
898RU-DD	Porcelain	75"H x 36 1/2"W x 21 1/2"D	82 lbs	\$523.12	
898RU-DC	Porcelain/Cork	75"H x 36 1/2"W x 21 1/2"D	71 lbs	\$523.12	
898RU-HH	Dura-Rite®	75"H x 36 1/2"W x 21 1/2"D	74 lbs	\$432.85	
898RU-HC	Dura-Rite®/Cork	75"H x 36 1/2"W x 21 1/2"D	71 lbs	\$461.84	

Reversible Boards



Please refer to p. 2 for a description of symbols.

Deluxe Reversible Board

- » Deluxe Reversible Boards provide twice the functional surface of a wall-mounted board.
- » Mobile boards are double-sided and available in a variety of surface combinations.
- » Surface rotates 360° on a pivot hinge and locks into place with the turn of a knob.
- » Available in 40"H x 30"W, 4'H x 5'W, and 4'H x 6'W with aluminum or wood trim.
- » Wide base design for stability includes 3" locking casters.
- » Optional silicone rubber accessory tray is customizable with your choice of color and desired text.



Deluxe Reversible Boards

A Aluminum Frame

Surface Combination	40"H x 30"W	Ship Wt.	Price	4'H x 5'W	Ship Wt.	Price	4'H x 6'W	Ship Wt.	Price	4'H x 8'W	Ship Wt.	Price
Porcelain Steel / Porcelain Steel	668AC-DD**	68 lbs	\$649.44	668AF-DD	129 lbs	\$818.11	668AG-DD	151 lbs	\$924.82	668AH-DD	176 lbs	\$1,063.54
Porcelain Steel / Natural Cork	668AC-DC**	68 lbs	\$625.35	668AF-DC	118 lbs	\$777.96	668AG-DC	130 lbs	\$876.63	668AH-DC	155 lbs	\$1,008.12
Dura-Rite® / Dura-Rite®	668AC-HH**	56 lbs	\$488.80	668AF-HH	110 lbs	\$577.15	668AG-HH	127 lbs	\$635.67	668AH-HH	152 lbs	\$731.02
Dura-Rite® / Natural Cork	668AC-HC**	69 lbs	\$524.37	668AF-HC	118 lbs	\$632.23	668AG-HC	118 lbs	\$702.22	668AH-HC	143 lbs	\$807.55
TuF-Rite® / TuF-Rite®	668AC-WW**	69 lbs	Call	668AF-WW	118 lbs	Call	668AG-WW	118 lbs	Call	668AH-WW	143 lbs	Call
TuF-Rite® / Natural Cork	668AC-WC**	69 lbs	Call	668AF-WC	118 lbs	Call	668AG-WC	118 lbs	Call	668AH-WC	143 lbs	Call
Natural Cork / Natural Cork	668AC-CC**	69 lbs	\$501.51	668AF-CC	118 lbs	\$560.99	668AG-CC	118 lbs	\$617.89	668AH-CC	143 lbs	\$710.57

B Natural Oak Frame

Surface Combination	40"H x 30"W	Ship Wt.	Price	4'H x 5'W	Ship Wt.	Price	4'H x 6'W	Ship Wt.	Price
Porcelain Steel / Porcelain Steel	668WC-DD**	68 lbs	\$649.44	668WF-DD	129 lbs	\$818.11	668WG-DD	151 lbs	\$924.82
Porcelain Steel / Natural Cork	668WC-DC**	68 lbs	\$625.35	668WF-DC	118 lbs	\$777.96	668WG-DC	130 lbs	\$876.63
Dura-Rite® / Dura-Rite®	668WC-HH**	56 lbs	\$488.80	668WF-HH	110 lbs	\$577.15	668WG-HH	127 lbs	\$635.67
Dura-Rite® / Natural Cork	668WC-HC**	69 lbs	\$524.37	668WF-HC	118 lbs	\$632.23	668WG-HC	118 lbs	\$702.22
TuF-Rite® / TuF-Rite®	668WC-WW**	69 lbs	Call	668WF-WW	118 lbs	Call	668WG-WW	118 lbs	Call
TuF-Rite® / Natural Cork	668WC-WC**	69 lbs	Call	668WF-WC	118 lbs	Call	668WG-WC	118 lbs	Call
Natural Cork / Natural Cork	668WC-CC**	69 lbs	\$474.14	668WF-CC	118 lbs	\$569.99	668WG-CC	118 lbs	\$617.89

C Mahogany Frame

Surface Combination	40"H x 30"W	Ship Wt.	Price	4'H x 5'W	Ship Wt.	Price	4'H x 6'W	Ship Wt.	Price
Porcelain Steel / Porcelain Steel	668CC-DD**	68 lbs	\$649.44	668CF-DD	129 lbs	\$818.11	668CG-DD	151 lbs	\$924.82
Porcelain Steel / Natural Cork	668CC-DC**	68 lbs	\$625.35	668CF-DC	118 lbs	\$777.96	668CG-DC	130 lbs	\$876.63
Dura-Rite® / Dura-Rite®	668CC-HH**	56 lbs	\$488.80	668CF-HH	110 lbs	\$577.15	668CG-HH	127 lbs	\$635.67
Dura-Rite® / Natural Cork	668CC-HC**	69 lbs	\$524.37	668CF-HC	118 lbs	\$632.23	668CG-HC	118 lbs	\$702.22
TuF-Rite® / TuF-Rite®	668CC-WW**	69 lbs	Call	668CF-WW	118 lbs	Call	668CG-WW	118 lbs	Call
TuF-Rite® / Natural Cork	668CC-WC**	69 lbs	Call	668CF-WC	118 lbs	Call	668CG-WC	118 lbs	Call
Natural Cork / Natural Cork	668CC-CC**	69 lbs	\$474.14	668CF-CC	118 lbs	\$569.99	668CG-CC	118 lbs	\$617.89

■ In Stock: ships within 48 hours of order. ■ Quick Ship: ships within 7 days of order.
*Ships UPS. **Ships UPS + \$9.00 handling fee.

Reversible Boards



A Porcelain Steel

Available with a variety of dry erase markerboard surfaces.

Surface rotates 360° and locks into place.

Full length accessory tray on either side.

Wide base design provides stability.

See coordinating Platinum Flat Panel Stand on p. 97!



Please refer to p. 2 for a description of symbols.

Platinum Reversible Board

- » Platinum Reversible Boards provide twice the functional surface of a wall-mounted board.
- » Mobile boards are double-sided and available in a variety of surface combinations. Surface rotates 360° on a pivot hinge and locks into place with the turn of a knob.
- » Available in 40"H x 30"W or 4'H x 6'W with modern anodized aluminum trim. Wide base design for stability includes 3" locking casters.
- » TAA compliant.

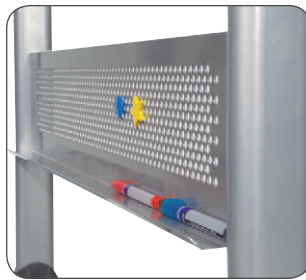
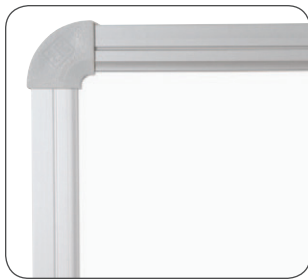

A Platinum Reversible Board

Surface Combination	40"H x 30"W	Ship Wt.	Price	4'H x 6'W	Ship Wt.	Price	4'H x 8'W	Ship Wt.	Price
Porcelain Steel / Porcelain Steel	■ 669RU-DD**	72 lbs	\$775.00	■ 669RG-DD	186 lbs	\$1,195.00	■ 669RH-DD	215 lbs	\$1,374.25
Porcelain Steel / Cork	■ 669RU-DC**	68 lbs	\$734.76	■ 669RG-DC	166 lbs	\$974.41	■ 669RH-DC	191 lbs	\$1,120.57
Dura-Rite® / Dura-Rite®	■ 669RU-HH**	80 lbs	\$605.81	■ 669RG-HH	120 lbs	\$854.93	■ 669RH-HH	145 lbs	\$839.39
Dura-Rite® / Cork	■ 669RU-HC**	65 lbs	\$655.69	■ 669RG-HC	132 lbs	\$817.48	■ 669RH-HC	157 lbs	\$940.10
Projection Plus® / Projection Plus®	■ 669RU-FF**	100 lbs	\$862.50	■ 669RG-FF	160 lbs	\$1,125.26	■ 669RH-FF	185 lbs	\$1,294.05
Projection Plus® / Cork	■ 669RU-FC**	100 lbs	\$793.15	■ 669RG-FC	160 lbs	\$1,052.27	■ 669RH-FC	185 lbs	\$1,210.11
Projection Plus® / Porcelain Steel	■ 669RU-FD**	76 lbs	\$829.65	■ 669RG-FD	173 lbs	\$1,169.05	■ 669RH-FD	198 lbs	\$1,344.41

■ In Stock: ships within 48 hours of order. ■ Quick Ship: ships within 7 days of order.
*Ships UPS. **Ships UPS + \$9.00 handling fee.

Reversible Boards



Please refer to p. 2 for a description of symbols.

Euro® Reversible Board

- » Euro® Reversible Boards provide twice the functional surface of a wall-mounted board.
- » Mobile boards are double-sided and available in a variety of surface combinations.
- » Surface rotates 360° on a pivot hinge and locks into place with the turn of a knob.
- » Available in 40"H x 30"W and 4'H x 6'W with modern black anodized aluminum trim.
- » Wide base design for stability includes 4" locking casters.
- » TAA compliant.



Euro® Reversible Board Surface Combination	40"H x 30"W			4'H x 6'W		
	Ship Wt.	Price		Ship Wt.	Price	
Porcelain Steel / Porcelain Steel	667RU-DD**	72 lbs	\$703.45	667RG-DD	163 lbs	\$990.05
Porcelain Steel / Cork	667RU-DC**	68 lbs	\$646.81	667RG-DC	155 lbs	\$858.28
Dura-Rite® / Dura-Rite®	667RU-HH**	75 lbs	\$533.40	667RG-HH	115 lbs	\$642.10
Dura-Rite® / Cork	667RU-HC**	68 lbs	\$577.76	667RG-HC	155 lbs	\$719.63
Projection Plus® / Projection Plus®	667RU-FF**	72 lbs	\$759.72	667RG-FF	163 lbs	\$1,069.20
Projection Plus® / Cork	667RU-FC**	68 lbs	\$698.54	667RG-FC	155 lbs	\$926.95
Projection Plus® / Porcelain Steel	667RU-FD**	72 lbs	\$731.56	667RG-FD	163 lbs	\$1,029.64

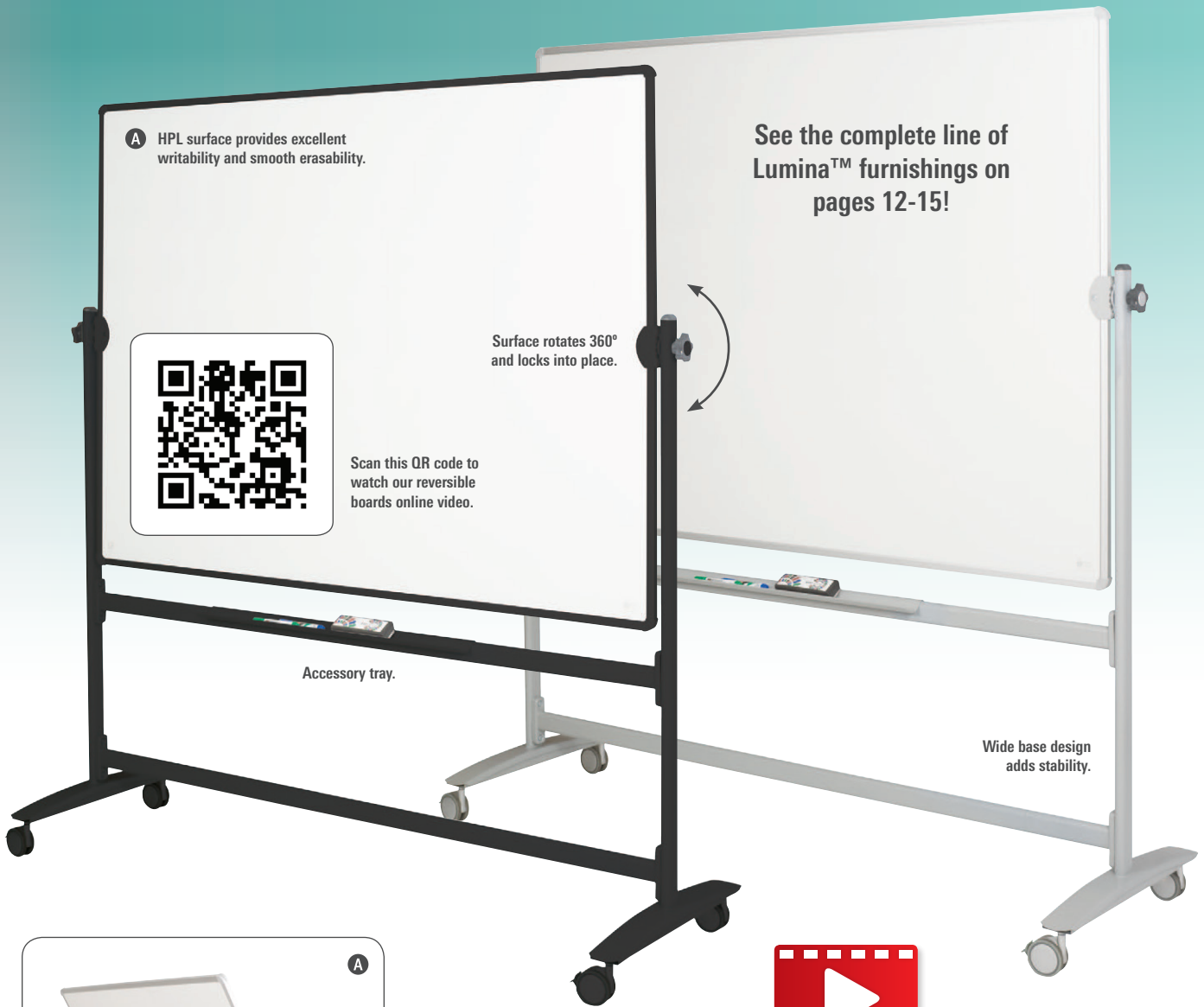

A HPL surface provides excellent writability and smooth erasability.



Scan this QR code to watch our reversible boards online video.

Surface rotates 360° and locks into place.

Accessory tray.

Wide base design adds stability.

See the complete line of Lumina™ furnishings on pages 12-15!



See product video online!
[youtube.com/moorecoinc](https://www.youtube.com/moorecoinc)



Please refer to p. 2 for a description of symbols.

Lumina™ Reversible Board

- » Mobile Lumina™ Reversible Boards provide twice the functional space of a traditional board.
- » Surface rotates 360° and locks into place with the turn of a knob.
- » Platinum or black powder-coated steel frame includes 3" casters (two locking).

Lumina™ Reversible Board				
Part No.	Color	Dimensions	Ship Wt.	Price
62382**	Platinum	40"H x 30"W	65 lbs	\$530.00
62383	Platinum	4'H x 5'W	110 lbs	\$744.00
62387**	Black	40"H x 30"W	65 lbs	\$655.79
62390	Black	4'H x 5'W	110 lbs	\$873.45

Room Dividers



Scan this QR code to watch our D.O.C. Partitions online video.



Please refer to p. 2 for a description of symbols.

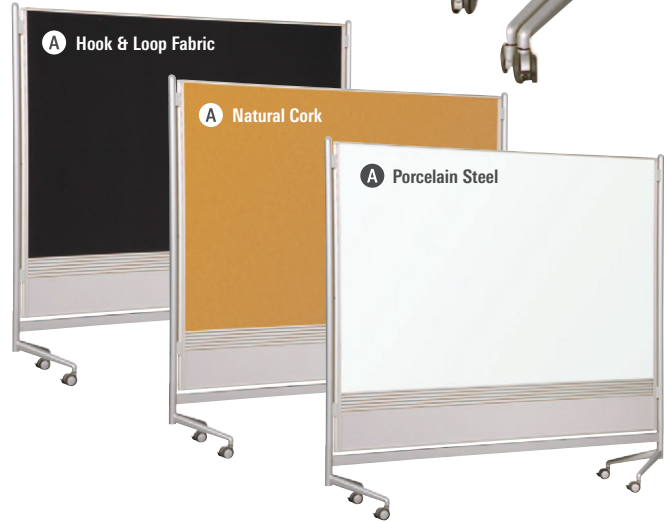

D.O.C. Partitions

- » D.O.C. Partitions allow you to divide, organize, and customize a work or display area.
- » GREENGUARD Indoor Air Quality Certified® and GREENGUARD Children & Schools CertifiedSM on select surface combinations and optional accessory trays.
- » Double sided dividers are available with a variety of surface combinations. Comes in 6'H x 4'W, 6'H x 6'W, or 6'H x 8'W with anodized aluminum trim and locking casters.
- » Slat panel along the bottom holds optional accessory trays.
- » TAA compliant.

D.O.C. Partitions									
Surface Combination	6'H x 4'W	Ship Wt.	Price	6'H x 6'W	Ship Wt.	Price	6'H x 8'W	Ship Wt.	Price
Porcelain Steel / Porcelain Steel	661AD-DD	130 lbs	\$798.60	661AG-DD	180 lbs	\$1,100.15	661AH-DD	220 lbs	\$1,280.85
Porcelain Steel / Cork	661AD-DC	130 lbs	\$732.49	661AG-DC	180 lbs	\$925.26	661AH-DC	220 lbs	\$1,165.13
Porcelain Steel / Hook & Loop	661AD-DN	130 lbs	\$798.60	661AG-DN	180 lbs	\$1,047.76	661AH-DN	220 lbs	\$1,280.85
Porcelain Steel / Laminate	661AD-DT	120 lbs	\$676.55	661AG-DT	160 lbs	\$864.50	661AH-DT	200 lbs	\$1,043.82
Dura-Rite® / Dura-Rite®	661AD-HH	110 lbs	\$554.48	661AG-HH	140 lbs	\$681.35	661AH-HH	180 lbs	\$806.80
Dura-Rite® / Cork	661AD-HC	110 lbs	\$601.91	661AG-HC	140 lbs	\$733.58	661AH-HC	180 lbs	\$876.52
Dura-Rite® / Hook & Loop	661AD-HN	110 lbs	\$601.91	661AG-HN	140 lbs	\$733.58	661AH-HN	180 lbs	\$876.52
Laminate / Laminate	661AD-TT	110 lbs	\$554.48	661AG-TT	140 lbs	\$681.35	661AH-TT	180 lbs	\$743.20
Optional Accessory Trays									
Part No.	Description	Ship Wt.	Price						
661PT*	3 Tray Set	5 ½ lbs	\$28.74						



Room Dividers



Please refer to p. 2 for a description of symbols.



Trek Mobile Room Divider

- » Turn any space into a multifunctional environment using the Trek Room Divider. Add to a personal workspace to allow for privacy or combine several to create a separate meeting area.
- » The magnetic dry erase surface lends further utility to this divider. Use as a message center or presentation easel.
- » The frame of the divider is painted steel and the 5" casters support ease in mobility.
- » Writing surface usable area: 65"x34 3/4".

A Trek Mobile Room Divider			
Part No.	Dimensions	Ship Wt.	Price
62406	74 1/4"H x 37 1/2"W x 20"D	65 lbs	\$387.48



Please refer to p. 2 for a description of symbols.

See product video online!
youtube.com/moorecoinc

Lumina™ Room Divider

- » Lumina™ Room Dividers feature a double sided magnetic dry erase markerboard surface.
- » Each divider comes with 3" casters (2 locking). Available in platinum or black.
- » Create a designer work space with other members of the Lumina™ series.

A Lumina™ Room Divider				
Part No.	Color	Dimensions	Ship Wt.	Price
74861	Platinum	72"H x 39 1/2"W x 20"D	55 lbs	\$562.00
27578	Black	72"H x 39 1/2"W x 20"D	55 lbs	\$624.74



See the complete line of Lumina™ furnishings on pages 12-15!



Please refer to p. 2 for a description of symbols.

Standard Modular Panels

- » Create walls, cubicles and other work or display areas with Standard Modular Panels.
- » Constructed with a lightweight 1 1/4" honeycomb core.
- » Framed in durable anodized aluminum.
- » Available in fabric or in half-and-half fabric and dry erase markerboard (blue fabric only).
- » Multiple connector options available to create custom configurations.



Standard Modular Panels

Part No.	Surface	Dimensions	Ship Wt.	Price
66215	Fabric	5'H x 3'W	17 lbs	\$201.08
66216	Fabric	5'H x 4'W	23 lbs	\$225.99
66217	Fabric	5'H x 5'W	29 lbs	\$277.93
66218	Fabric	6'H x 3'W	20 lbs	\$254.19
66219	Fabric	6'H x 4'W	27 lbs	\$273.16
66220	Fabric	6'H x 5'W	34 lbs	\$319.80
66223	MB/Fab (Blue)	6'H x 3'W	22 lbs	\$418.24
66224	MB/Fab (Blue)	6'H x 4'W	30 lbs	\$440.40

Standard Modular Panel Connectors

Part No.	Description	Ship Wt.	Price	Part No.	Description	Ship Wt.	Price
66200*	T-Base Side (pair)	4 lbs	\$41.55	66209*	2-Way Right Connector	1 lb	\$6.57
66201*	Adjustable Glides (pair)	2 lbs	\$15.37	66210*	2-Way Right Connector w/Leg	2 lbs	\$20.67
66203*	Casters (set of 4)	2 lbs	\$16.06	66211*	3-Way Right Connector	1 lb	\$8.90
66204*	T-Base w/casters (pair)	6 lbs	\$57.45	66212*	3-Way Right Connector w/Leg	2 lbs	\$21.84
66205*	Wall Connector	1 lb	\$6.04	66213*	4-Way Right Connector	1 lb	\$10.71
66206*	2-Way Straight Connector	1 lb	\$5.30	66214*	4-Way Right Connector w/Leg	2 lbs	\$23.64
66207*	2-Way Straight Connector w/Leg	2 lbs	\$16.54				
66208*	T-Base Foot (pair)	4 lbs	\$22.47				



Arrange in a variety of configurations.

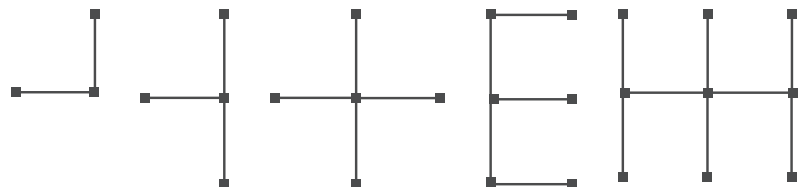

Room Dividers



Scan this QR code to watch this product's online video.

Fully assembled!
Set up and go!

Write
On Me!

Unlock and
pull open

FREE space planning
service available!



See product video online!
[youtube.com/moorecoinc](https://www.youtube.com/moorecoinc)



Please refer to p. 2 for a description of symbols.

- » Mix and match surfaces!
- » Add and subtract panels with ease!
- » Switch dirty or damaged panels on the fly!

Great Divide® Wall Panel System

- » The Great Divide® expandable modular wall panel system adapts to your changing needs.
- » Fully assembled for the ultimate in convenience!
- » Easy to expand and change with add-on panel sets. Purchase add-on sets now or anytime in the future. Mix and match surfaces for superior versatility! Save money by not having to purchase another complete set. Add-on sets require assembly.
- » Unique laminate and markerboard panels are durable, scratch-resistant, don't support microbial growth, and are easy to clean!
- » Fabric panels durable, tackable, flame resistant and available in gray or blue.
- » 5 year guarantee. May be TAA compliant.

FREE Space Planning forms can be downloaded and printed from our web site at www.moorecoinc.com/space-planning.

- » On the FREE Space Planning Form, just sketch the area(s) you would like divided.
- » Then tell us what you would like us to do by thoroughly filling out the information at the bottom of the form.
- » We'll then supply you with a computer generated layout of your facility based on your needs.

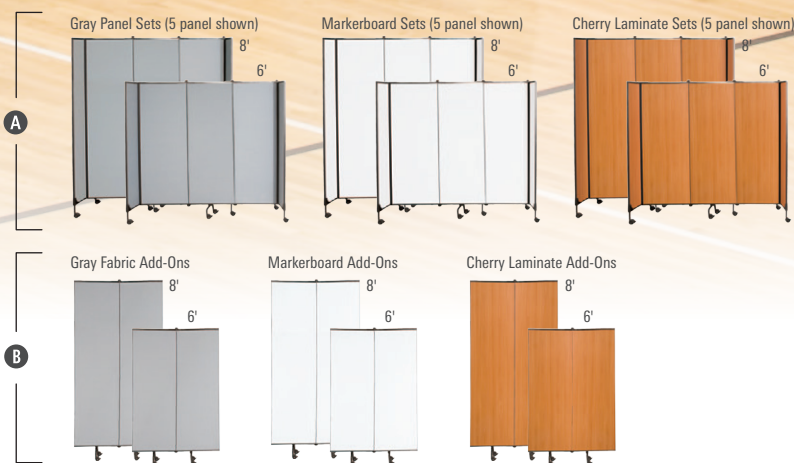
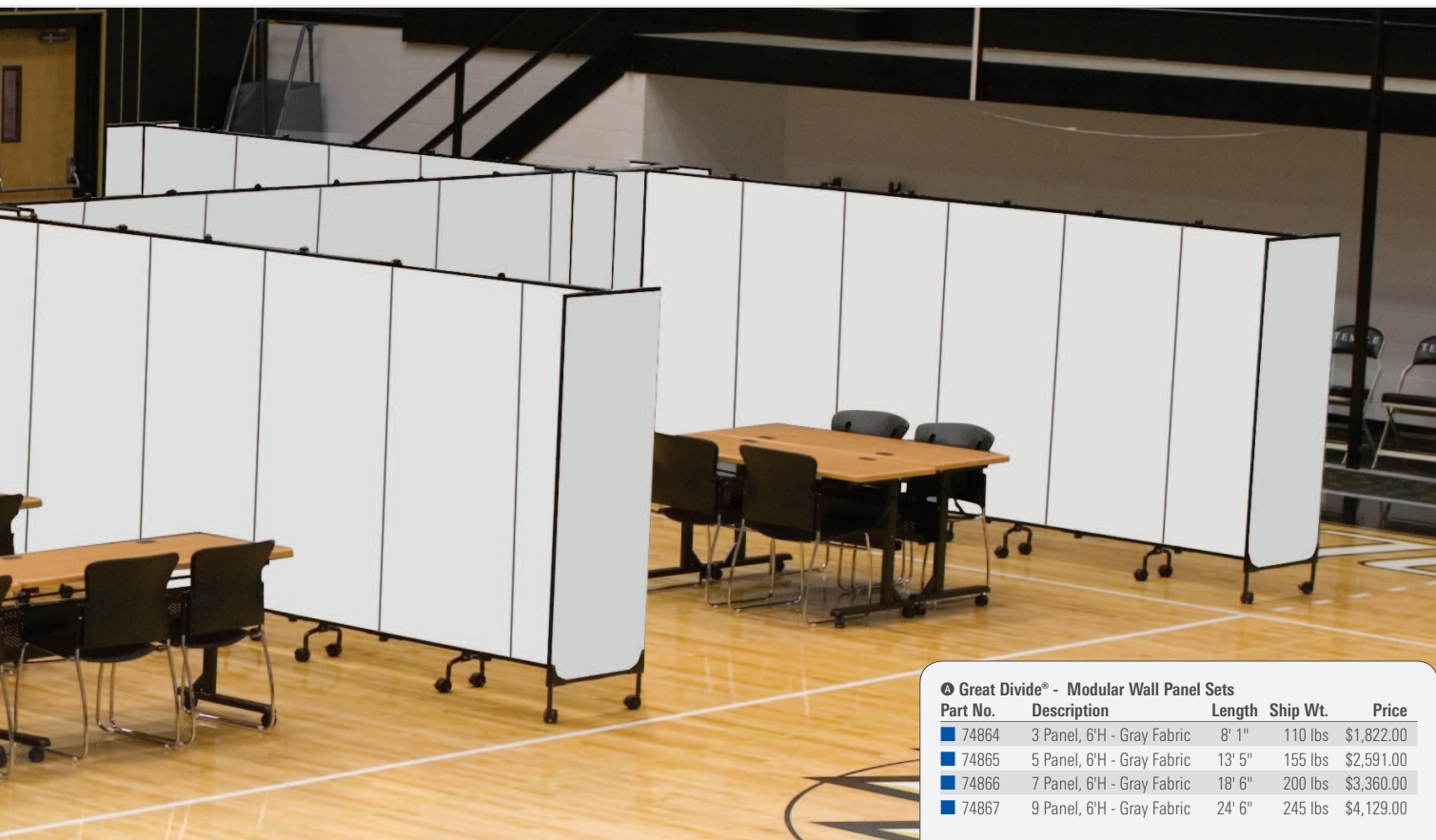

Only Great Divide® Panels offer the ability to change panel surfaces on the fly, saving time and money!

Please specify color when ordering.



Great Divide® - Modular Wall Panel Sets

Part No.	Description	Length	Ship Wt.	Price
74864	3 Panel, 6'H - Gray Fabric	8' 1"	110 lbs	\$1,822.00
74865	5 Panel, 6'H - Gray Fabric	13' 5"	155 lbs	\$2,591.00
74866	7 Panel, 6'H - Gray Fabric	18' 6"	200 lbs	\$3,360.00
74867	9 Panel, 6'H - Gray Fabric	24' 6"	245 lbs	\$4,129.00
74868	3 Panel, 8'H - Gray Fabric	8' 1"	143 lbs	\$2,259.00
74869	5 Panel, 8'H - Gray Fabric	13' 5"	200 lbs	\$3,188.00
74870	7 Panel, 8'H - Gray Fabric	18' 6"	257 lbs	\$4,117.00
74871	9 Panel, 8'H - Gray Fabric	24' 6"	314 lbs	\$5,046.00
74880	3 Panel, 6'H - Markerboard	8' 1"	110 lbs	\$1,765.00
74881	5 Panel, 6'H - Markerboard	13' 5"	155 lbs	\$2,604.00
74882	7 Panel, 6'H - Markerboard	18' 6"	200 lbs	\$3,443.00
74883	9 Panel, 6'H - Markerboard	24' 6"	245 lbs	\$4,282.00
74884	3 Panel, 8'H - Markerboard	8' 1"	143 lbs	\$2,199.00
74885	5 Panel, 8'H - Markerboard	13' 5"	200 lbs	\$3,198.00
74886	7 Panel, 8'H - Markerboard	18' 6"	257 lbs	\$4,197.00
74887	9 Panel, 8'H - Markerboard	24' 6"	314 lbs	\$5,196.00
74888	3 Panel, 6'H - Laminate	8' 1"	110 lbs	\$1,765.00
74889	5 Panel, 6'H - Laminate	13' 5"	155 lbs	\$2,494.00
74891	7 Panel, 6'H - Laminate	18' 6"	200 lbs	\$3,223.00
74892	9 Panel, 6'H - Laminate	24' 6"	245 lbs	\$3,952.00
74893	3 Panel, 8'H - Laminate	8' 1"	143 lbs	\$2,199.00
74894	5 Panel, 8'H - Laminate	13' 5"	200 lbs	\$3,198.00
74895	7 Panel, 8'H - Laminate	18' 6"	257 lbs	\$4,197.00
74896	9 Panel, 8'H - Laminate	24' 6"	314 lbs	\$5,196.00

Great Divide® - Modular Wall Panel Add-On Sets

Part No.	Description	Length	Ship Wt.	Price
74769	2 Panel, 6'H - Gray Fabric	5' 4"	45 lbs	\$807.45
74771	2 Panel, 8'H - Gray Fabric	5' 4"	57 lbs	\$975.45
74784	2 Panel, 6'H - Markerboard	5' 4"	45 lbs	\$880.95
74785	2 Panel, 8'H - Markerboard	5' 4"	57 lbs	\$1,048.95
74790	2 Panel, 6'H - Laminate	5' 4"	45 lbs	\$729.00
74791	2 Panel, 8'H - Laminate	5' 4"	57 lbs	\$916.00

Ganging Device Set

Part No.	Description	Ship Wt.	Price
56345*	Set of 4 Connectors	1 lb	\$61.79

■ In Stock: ships within 48 hours of order. ■ Quick Ship: ships within 7 days of order.
*Ships UPS. **Ships UPS + \$9.00 handling fee.

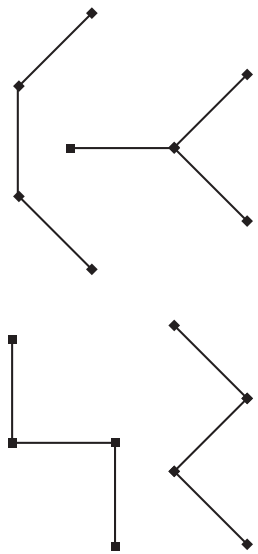



Royal (59)

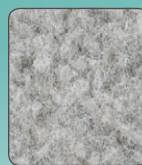

Silver (61)



Pacific Blue (47)

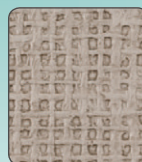

Gray (44)



Please refer to p. 2 for a description of symbols.

Mobile Floor Display Panels

- » Mobile Floor Display Panels provide a versatile way to display artwork or information.
- » Ideal for use as temporary partitions or room dividers.
- » Available with either hook-and-loop fabric surface or with an easy to clean vinyl surface.
- » Surface is tackable and fully framed in anodized aluminum trim.
- » Side hinges allow panels to attach at various angles to create a variety of configurations.
- » For single panel set ups, caster legs (included with each panel) allow easy mobility.
- » Made in the USA. TAA compliant.



A Mobile Floor Display Panel - Single

Part No.	Surface	Dimensions	Ship Wt.	Price
689D-59	Royal Hook & Loop	78"H x 50"W	50 lbs	\$515.88
689D-61	Silver Hook & Loop	78"H x 50"W	50 lbs	\$515.88
689D-47	Pacific Blue Vinyl	78"H x 50"W	50 lbs	\$362.13
689D-44	Gray Vinyl	78"H x 50"W	50 lbs	\$362.13

B Mobile Floor Display Panel - Set of 3

Part No.	Surface	Dimensions	Ship Wt.	Price
689D3-59	Royal Hook & Loop	78"H x 150"W	150 lbs	\$1,216.95
689D3-61	Silver Hook & Loop	78"H x 150"W	150 lbs	\$1,216.95
689D3-47	Pacific Blue Vinyl	78"H x 150"W	150 lbs	\$983.07
689D3-44	Gray Vinyl	78"H x 150"W	150 lbs	\$983.07

Display Panels



Please refer to p. 2 for a description of symbols.

Portable Display Panels

- » Portable Display Panels are ideal for smaller areas, including early childhood environments.
- » Create display areas, or divide larger rooms into smaller work areas ideal for activity stations.
- » Lightweight panels are easily portable to make changing configurations effortless.
- » Interlocking flat leg allows arrangement without hinges, eliminating the danger of pinching.
- » Tackable surface available in royal blue hook and loop fabric or in easy to clean gray vinyl.
- » Each panel is framed in durable anodized aluminum trim.
- » Made in the USA. TAA compliant.



Please specify color when ordering.



Royal Hook & Loop (59)



Gray Vinyl (44)

Portable Display Panels

Part No.	Description	Dimensions	Ship Wt.	Price
685D-59	Royal Hook & Loop	55"H x 40"W	53 lbs	\$339.04
685D-44	Gray Vinyl	55"H x 40"W	53 lbs	\$312.73

B



Please refer to p. 2 for a description of symbols.

Tri-Fold Information Center

- » The Tri-Fold Information Center is an ideal display medium for trade shows or art exhibits.
- » Three 23" wide panels (either 48" or 66"H) are joined by a full-length pinch-proof piano hinge.
- » Panels feature hook-and-loop fabric and anodized aluminum Euro® trim. In stock in black fabric only.
- » Plastic feet protect floor surfaces, and the unit folds flat for easy and compact storage.
- » Made in the USA. TAA compliant.

Tri-Fold Information Center

Part No.	Dimensions	Ship Wt.	Price
718R4**	48"H x 47"W x 1/2"D	35 lbs	\$480.29
718R5**	66"H x 47"W x 1/2"D	47 lbs	\$600.65

Please specify color when ordering.



In Stock Black (91)



Flame (60)



Madison (62)



Royal (59)

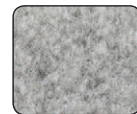

Silver (61)



Venice (63)



Please refer to p. 2 for a description of symbols.

Economy Tabletop Display

- » The Economy Tabletop Display Panel features a 24"W middle panel and two 12"W side panels.
- » Pinch-proof full-length piano hinges join the 1/2" thick panels together.
- » Tackable panel fabric available in five colors with a silver anodized aluminum frame.
- » In stock in black hook and loop fabric with a black anodized aluminum frame.
- » Made in the USA. TAA compliant.

● Economy Tabletop Display

Part No.	Item	Dimensions	Ship Wt.	Price
716*	Fabric	30"H x 48"W x 1/2"D	15 lbs	\$202.16
716B*	Hook & Loop	30"H x 48"W x 1/2"D	15 lbs	\$260.81

A

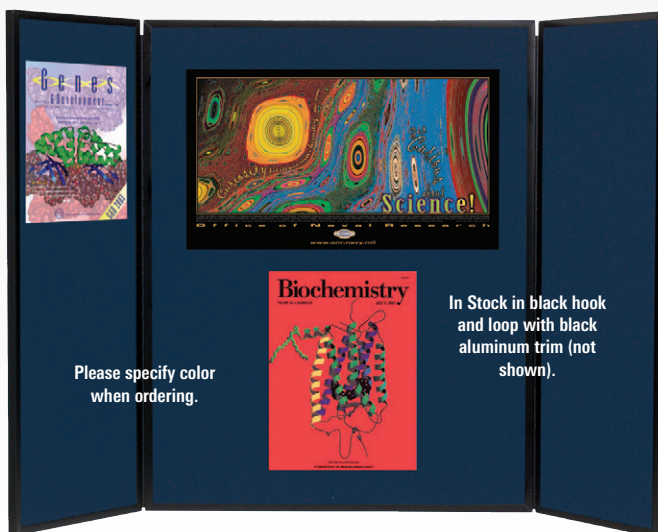

Please refer to p. 2 for a description of symbols.

B

Portable Presentation Display

- » The Portable Presentation Display is lightweight and folds out instantly for easy use.
- » Available in 36"H or 48"H. Panels measure 24 3/4"W x 3/4"D.
- » Joined with full-length pinch-proof piano hinges. Folds to 3"D for easy storage.
- » Choose from six hook-and-loop fabric colors framed in silver or black anodized aluminum Euro® trim.
- » Made in the USA. TAA compliant.

● Portable Presentation Display

Part No.	Item	Dimensions	Ship Wt.	Price
714*	36" Display	36"H x 96"W x 1/2"D	28 lbs	\$281.81
714B*	36" Display (black)	36"H x 96"W x 1/2"D	28 lbs	\$485.61
715**	48" Display	48"H x 96"W x 1/2"D	42 lbs	\$364.42
715B**	48" Display (black)	48"H x 96"W x 1/2"D	42 lbs	\$486.05



Please refer to p. 2 for a description of symbols.

Tabletop Display Panel with Header

- » The Tabletop Display Panel sets up in seconds with no tools required.
- » Side panels measure 24"H x 36"W and the tall middle panel (48"H) serves to create a header.
- » Framed in black anodized aluminum, the display is double-hinged, and folds flat for storage.
- » Made in the USA. TAA compliant.

Please specify color when ordering.



Black (91)



Flame (60)



Madison (62)



■ In Stock
Royal Blue (59)



Silver (61)



Venice (63)

● Tabletop Display Panel with Header

Part No.	Item	Dimensions	Ship Wt.	Price
719B*	Tabletop Display Panel	72"H x 48"W x 1/2"D	18 lbs	\$415.24

C

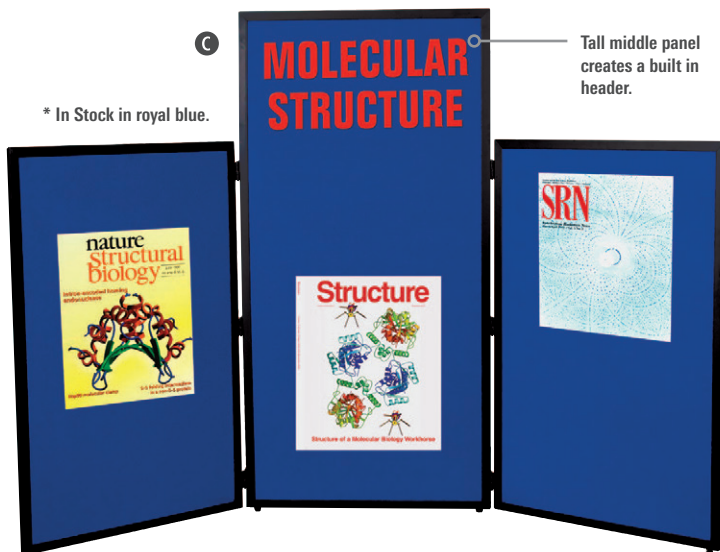

Display Panels



Please refer to p. 2 for a description of symbols.

Swinging Floor Display Panels

- » Swinging Floor Display Panels are ideal for photographs, artwork, posters, or other exhibitions.
- » Available to hold 10 or 20 double-sided 40"H x 30"W panels at eye level for optimum viewing.
- » White matboard or hook-and-loop fabric surface feature acrylic overlays to protect items.
- » The frame is made of white powder-coated steel with a stretcher bar.

Please specify color when ordering.



Swinging Floor Display Panels				
Part No.	Description	Dimensions	Ship Wt.	Price
694UG-10	Standard - White (Set of 10)	71"H x 35"W x 35"D	271 lbs	\$1,797.75
694UG-20	Standard - White (Set of 20)	71"H x 62 1/2"W x 35"D	490 lbs	\$3,311.79
694UG-10-59	Standard - Royal (Set of 10)	71"H x 35"W x 35"D	310 lbs	\$2,315.94
694UG-20-59	Standard - Royal (Set of 20)	71"H x 62 1/2"W x 35"D	554 lbs	\$4,255.54



Quick Ship in royal blue fabric or white matboard.



Please refer to p. 2 for a description of symbols.

Swinging Wall Display Panels

- » Swinging Wall Display Panels are available in a standard or full-view model.
- » Full-view model allows panels to open flat for complete viewing.
- » Each display holds ten 40"H x 30"W panels, ideal for exhibition areas.
- » Available in white matboard or royal hook and loop fabric, panels feature acrylic overlay.
- » May be TAA compliant.

Please specify color when ordering.

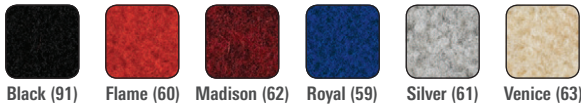

Swinging Wall Display Panels - Standard				
Part No.	Item	Dimensions	Ship Wt.	Price
698UG-10	Standard - White (10)	48"H x 35"W x 35"D	294 lbs	\$1,838.27
698UG-20	Standard - White (20)	48"H x 62 1/2"W x 35"D	300 lbs	\$3,285.74
698UG-10-59	Standard - Royal (10)	48"H x 35"W x 35"D	324 lbs	\$2,294.85
698UG-20-59	Standard - Royal (20)	48"H x 62 1/2"W x 35"D	364 lbs	\$4,331.82

Swinging Wall Display Panels - Full View				
Part No.	Item	Dimensions	Ship Wt.	Price
696UG-10	Full View - White (10)	48"H x 72"W x 37"D	248 lbs	\$1,734.06
696UG-10-59	Full View - Royal (10)	48"H x 72"W x 37"D	300 lbs	\$2,168.29



Quick Ship in royal blue fabric or white matboard.



Full View

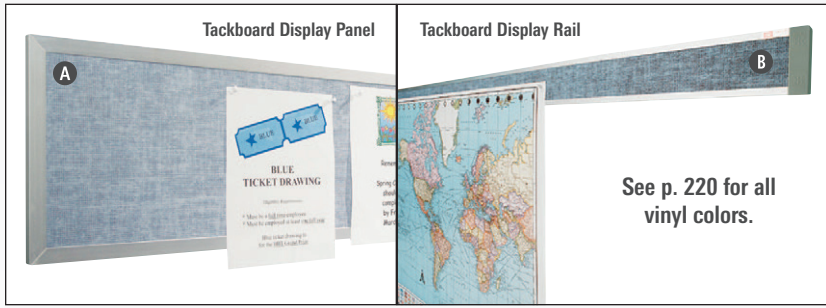

See p. 220 for all vinyl colors.

Tackboard Display Panels & Rails

- » Tackboard Display Panels and Rails turn any blank wall into instant display space.
- » Ideal for hanging artwork, posters, maps, or other information.
- » Available in natural cork or in easy to clean vinyl over insulation board.
- » 10 year guarantee.



Please refer to p. 2 for a description of symbols.

Please specify color when ordering.



A Tackboard Display Panels

Part No.	Dimensions	Ship Wt.	Price
■ 507AG*	11 3/4"H x 6'W	12 lbs	\$89.53
■ 507AH*	11 3/4"H x 8'W	16 lbs	\$125.56

B Tackboard Display Rails

Part No.	Dimensions	Ship Wt.	Price
■ 506AC*	3" x 3'	4 lbs	\$25.04
■ 506AD*	3" x 4'	5 lbs	\$32.74
■ 506AG*	3" x 6'	6 lbs	\$48.15
■ 506AH**	3" x 8'	7 lbs	\$63.56

C Tack Bite - Sets

Part No.	Item	Size	Ship Wt.	Price
■ 504-0*	Set of 6	7" long	2 lbs	Call
■ 504-1*	Set of 6	1' long	4 lbs	Call
■ 504-2*	Set of 6	2' long	6 lbs	Call
■ 504-3*	Set of 6	3' long	8 lbs	Call
■ 504-4*	Set of 6	4' long	12 lbs	Call
■ 504-6**	Set of 6	6' long	16 lbs	Call
■ 504-8**	Set of 4	8' long	20 lbs	Call

D Map Rails - 1"

Part No.	Dimensions	Ship Wt.	Price
■ 522D*	1"H x 4'W (set of 6)	6 lbs	\$71.33
■ 522G*	1"H x 6'W (set of 6)	8 lbs	\$104.34
■ 522H**	1"H x 8'W (set of 6)	10 lbs	\$135.18
■ 522K	1"H x 10'W (set of 6)	27 lbs	\$153.37
■ 522M	1"H x 12'W (set of 6)	33 lbs	\$178.67
■ 510*	1" Hook Clip		\$2.83
■ 512*	1" Flag Holder (w-hook clip)		\$4.95
■ 514*	1" Map Winder (pr)		\$11.21
■ 516*	1" End Stops (pr)		\$4.12

E Map Rails - 2"

Part No.	Dimensions	Ship Wt.	Price
■ 523D*	2"H x 4'W (set of 6)	6 lbs	\$112.04
■ 523G*	2"H x 6'W (set of 6)	8 lbs	\$165.30
■ 523H**	2"H x 8'W (set of 6)	10 lbs	\$216.51
■ 523K	2"H x 10'W (set of 6)	27 lbs	\$265.85
■ 523M	2"H x 12'W (set of 6)	33 lbs	\$313.25
■ 511*	2" Hook Clip		\$3.19
■ 513*	2" Flag Holder (w-hook clip)		\$5.30
■ 515*	2" Map Winder (pr)		\$11.40
■ 517*	2" End Stops (pr)		\$4.34

F Best-Bite® - Sets

Part No.	Item	Size	Ship Wt.	Price
■ 505-0*	Set of 6	7" long	2 lbs	\$51.49
■ 505-1*	Set of 6	1' long	4 lbs	\$65.73
■ 505-2*	Set of 6	2' long	6 lbs	\$104.67
■ 505-3*	Set of 6	3' long	8 lbs	\$157.14
■ 505-4*	Set of 6	4' long	12 lbs	\$186.29
■ 505-6**	Set of 6	6' long	16 lbs	\$253.39
■ 505-8**	Set of 4	8' long	20 lbs	\$225.27

Please refer to p. 2 for a description of symbols.



Tack Bite

- » Tack Bite is an innovative and safe way to display documents, posters or pictures.
- » Features a tack strip combines with a unique tackless paper holder. Tackless roller system provides a secure hold and quick release. Simply push in and lift out.
- » 10 year guarantee. TAA compliant.



NEW!

Includes tack strip and tackless paper holder in one!



Please refer to p. 2 for a description of symbols.



Map Rails

- » Durable Map Rails turn any empty wall space into instant display space.
- » 1" or 2" natural cork or recycled rubber Retire strips in anodized aluminum extrusions.
- » Hook clips, flag holders, map winders, and end stops available separately.
- » Please specify cork or Retire recycled rubber insert.



Unique roller holds securely without damage.



Please refer to p. 2 for a description of symbols.



Best-Bite®

- » Best-Bite® tackless paper holders are an innovative and safe way to display documents, posters or pictures without leaving unsightly and damaging holes.
- » Unique roller system provides a secure hold and quick release. Simply push in and lift out.
- » 10 year guarantee.

Display Rails

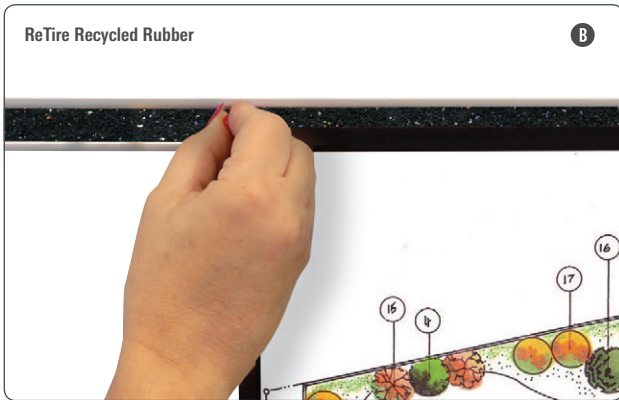

Is  Please refer to p. 2 for a description of symbols.

Bulletin Bars

- » The Bulletin Bar consists of a tan colored cork or Retire recycled rubber strip encased in a 1" satin aluminum extrusion.
- » Available in a variety of lengths, bars are sold in packages of 12 with a set of 40 push pins.

A Bulletin Bars (12) - Colored Cork				B Bulletin Bars (12) - ReTire Rubber			
Part No.	H x W	Ship Wt.	Price	Part No.	H x W	Ship Wt.	Price
■ 558-1*	1"H x 1'W	3 lbs	\$79.68	■ 558-1-106*	1"H x 1'W	3 lbs	\$75.70
■ 558-2*	1"H x 2'W	7 lbs	\$138.94	■ 558-2-106*	1"H x 2'W	7 lbs	\$131.99
■ 558-3*	1"H x 3'W	10 lbs	\$173.91	■ 558-3-106*	1"H x 3'W	10 lbs	\$165.21
■ 558-4*	1"H x 4'W	15 lbs	\$200.05	■ 558-4-106*	1"H x 4'W	15 lbs	\$190.05

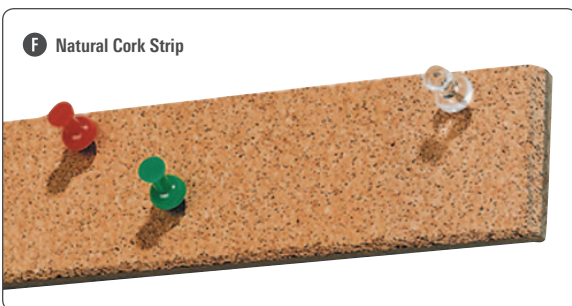

Natural Cork Strips

- » Cork Strips turn any blank wall into instant display space.
- » A layer of 1/4" natural cork laminated to 1/4" hardboard for strength and durability.
- » Sold in sets of six. Comes with free set of push pins.

Is Please refer to p. 2 for a description of symbols.

F Cork Strips			
Part No.	Dimensions	Ship Wt.	Price
■ 508*	1 3/4"H x 4'W (Set of six strips)	10 lbs	\$63.34



Brite Bulletin Bars

- » Brite Bulletin Bars add color and tackable display space to any early childhood environment.
- » Plastic bars feature a strip of cork that is mounted in a red, blue, or black plastic extrusion.
- » Sold in sets of 12 in a variety of lengths. 72 push pins are included with each set.
- » Magnets and double-sided adhesive tape are included for mounting.

Is
Please refer to p. 2 for a description of symbols.

C Brite Bulletin Bars (12 per case)			
Part No.	Dimensions	Ship Wt.	Price
■ 558C1*	1"H x 12"W	3 lbs	\$71.40
■ 558C2*	1"H x 24"W	7 lbs	\$102.46
■ 558C3*	1"H x 36"W	10 lbs	\$135.61





Trim Options:



Coffee

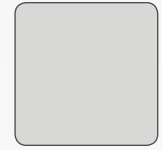

Silver

Please specify back panel material and color when ordering. See p. 220 for full tackboard swatches.



Natural Cork



Rubber-Tak



Vinyl



Please refer to p. 2 for a description of symbols.

Indoor Enclosed Bulletin Board Cabinet

- » Indoor Enclosed Bulletin Board Cabinets feature elegant trim available in silver or coffee aluminum.
- » Comes with up to three locking hinged doors with shatter-resistant clear acrylic panels.
- » Available standard with a natural cork or vinyl tackable back panel. Rubber-Tak available at an upcharge. Call for details. Please specify back panel material and color choice.
- » Made in the USA. TAA compliant.

Indoor Enclosed Bulletin Board Cabinet

Silver	Coffee	Doors	Dimensions	Ship Wt.	Price (Silver)	Price (Coffee)
94PSA-I	94PCA-I	1	24"H x 18"W	10 lbs	\$185.17	\$185.17
94PSB-I	94PCB-I	1	36"H x 24"W	20 lbs	\$319.00	\$308.61
94PSU-I	94PCU-I	1	36"H x 30"W	26 lbs	\$350.00	\$379.92
94PS1-I	94PC1-I	1	36"H x 36"W	31 lbs	\$368.99	\$383.18
94PSC-I	94PCC-I	2	36"H x 48"W	35 lbs	\$514.00	\$551.00
94PSE-I	94PCE-I	2	36"H x 60"W	48 lbs	\$625.94	\$662.76
94PS2-I	94PC2-I	3	36"H x 72"W	57 lbs	\$758.00	\$837.35
94PSG-I	94PCG-I	3	48"H x 72"W	75 lbs	\$828.88	\$964.62
94PSH-I	94PCH-I	3	48"H x 96"W	110 lbs	\$1,144.00	\$1,186.70

Interior Lighting Kit

Part No.	Description	Ship Wt.	Price
66568*	1 kit per 2 linear feet recommended	2 lbs	\$75.00



Please refer to p. 2 for a description of symbols.

Deluxe Bulletin Board Cabinet

- » The Deluxe Bulletin Board Cabinet features a 2" deep display area.
- » Available with sliding doors or with doors attached with full-length pinch-proof piano hinges.
- » Tempered glass doors are 3/16" thick and are lockable to help prevent tampering.
- » Framed with 1 3/4"W x 3"D heavy gauge anodized aluminum.
- » Tackable back panel available in natural cork, or choose any vinyl or fabric coverings.
- » Made in the USA. TAA compliant.

Deluxe Bulletin Board Cabinet

Part No.	Doors	Dimensions	Ship Wt.	Price
95HAB	1 Hinged	3'H x 2'W	54 lbs	\$384.95
95HAV	1 Hinged	3'H x 3'W	81 lbs	\$564.43
95HAC	2 Hinged	3'H x 4'W	108 lbs	\$796.51
95HAD	2 Hinged	4'H x 4'W	144 lbs	\$951.05
95HAF	2 Hinged	4'H x 5'W	200 lbs	\$1,113.95
95HAG	2 Hinged	4'H x 6'W	230 lbs	\$1,260.40
95HAH	4 Hinged	4'H x 8'W	290 lbs	\$1,824.96

95HAK	4 Hinged	4'H x 10'W	400 lbs	\$2,150.00
95HAM	4 Hinged	4'H x 12'W	460 lbs	\$2,435.19
95SAC	2 Sliding	3'H x 4'W	110 lbs	\$647.96
95SAE	2 Sliding	3'H x 5'W	160 lbs	\$842.84
95SAF	2 Sliding	4'H x 5'W	200 lbs	\$966.58
95SAG	2 Sliding	4'H x 6'W	230 lbs	\$1,128.96

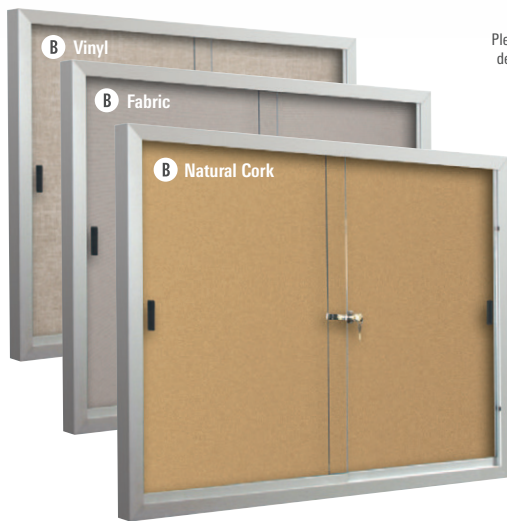

Please refer to p. 2 for a description of symbols.



Standard Bulletin Board Cabinet

- » The Standard Bulletin Board Cabinet provides an economical yet attractive display space.
- » Framed in 1"W x 2"D anodized aluminum tubing with a 1" internal depth.
- » Back panel available in natural cork, vinyl, or fabric covered tackable surface..

Standard Bulletin Board Cabinet

Part No.	Doors	Dimensions	Ship Wt.	Price
94HAB	1 Hinged	3'H x 2'W	54 lbs	\$326.93
94HAV	1 Hinged	3'H x 3'W	81 lbs	\$482.45
94HAC	2 Hinged	3'H x 4'W	108 lbs	\$643.39
94HAD	2 Hinged	4'H x 4'W	144 lbs	\$848.27
94HAF	2 Hinged	4'H x 5'W	200 lbs	\$911.44
94HAG	2 Hinged	4'H x 6'W	230 lbs	\$1,045.55
94HAH	4 Hinged	4'H x 8'W	290 lbs	\$1,669.79
94HAK	4 Hinged	4'H x 10'W	400 lbs	\$1,935.45
94HAM	4 Hinged	4'H x 12'W	460 lbs	\$2,203.39
94SAC	2 Sliding	3'H x 4'W	110 lbs	\$587.41
94SAE	2 Sliding	3'H x 5'W	160 lbs	\$845.70
94SAF	2 Sliding	4'H x 5'W	200 lbs	\$909.28
94SAG	2 Sliding	4'H x 6'W	230 lbs	\$1,059.27



Please refer to p. 2 for a description of symbols.



Wood Trim Bulletin Board Cabinet

- » Wood Trim Board Cabinets available in oak or walnut stain.
- » Up to three locking hinged doors with shatter-resistant clear acrylic panels.
- » Available with a natural cork tackable back panel.

Wood Trim Bulletin Board Cabinet

Oak	Walnut	Doors	Dimensions	Ship Wt.	Price (Oak)	Price (Walnut)
94HWA	94HNA	1 Hinged	24"H x 18"W	10 lbs	\$144.72	\$302.61
94HWB	94HNB	1 Hinged	36"H x 24"W	20 lbs	\$233.81	\$340.08
94HWU	94HNU	1 Hinged	36"H x 30"W	26 lbs	\$562.80	\$562.80
94HW1	94HN1	1 Hinged	36"H x 36"W	31 lbs	\$585.00	\$585.00
94HWC	94HNC	2 Hinged	36"H x 48"W	35 lbs	\$388.27	\$608.88
94HWE	94HNE	2 Hinged	48"H x 60"W	48 lbs	\$766.08	\$766.08
94HW2	94HN2	3 Hinged	48"H x 72"W	57 lbs	\$1,036.32	\$1,036.32
94HWG	94HNG	3 Hinged	48"H x 72"W	75 lbs	\$1,078.90	\$1,078.90
94HWH	94HNH	3 Hinged	48"H x 96"W	110 lbs	\$1,307.75	\$1,307.75



Weather stripping on all door openings.



Top hinge style cabinet. Available in smaller sizes only.



Side hinge style cabinet.

Also available in 2 door model.



Please refer to p. 2 for a description of symbols.

Weather Sentinel

- » Protect your displayed items from the sun and the rain with a Weather Sentinel™ outdoor enclosed bulletin board cabinet.
- » Keeps water out with a top-mounted drip rail, galvanized steel back panel sealed with silicone, and weather stripping on all door openings.
- » Anodized aluminum steel trim and a virtually indestructible and moisture-resistant Rubber-Tak back panel provide protection from UV rays. Also available with a half Rubber-Tak and half porcelain steel dry erase back panel.
- » Choose a cabinet with a top hinge, or a side hinge set up with either a single or double door. Locks prevent tampering.
- » Made in the USA. TAA compliant. 5 year guarantee.

Weather Sentinel

Part No.	Back Panel Material	Door Style	Dimensions	Ship Wt.	Price
94HAAT-O-RT	Rubber-Tak	1 - Top Hinge	24"W x 18"H	11 lbs	\$328.28
94HABT-O-RT	Rubber-Tak	1 - Top Hinge	36"W x 24"H	22 lbs	\$717.93
94HACT-O-RT	Rubber-Tak	1 - Top Hinge	48"W x 36"H	29 lbs	\$910.35
94HAC2S-O-RT	Rubber-Tak	1 - Side Hinge	24"W x 48"H	29 lbs	\$717.85
94HACS-O-RT	Rubber-Tak	1 - Side Hinge	36"W x 48"H	29 lbs	\$825.71
94HAC-O-RT	Rubber-Tak	2 - Side Hinge	48"W x 36"H	29 lbs	\$1,018.08
94HAD-O-RT	Rubber-Tak	2 - Side Hinge	48"W x 48"H	55 lbs	\$1,233.33
94HAG-O-RT	Rubber-Tak	2 - Side Hinge	72"W x 48"H	82 lbs	\$1,413.66
94HACC-O-RT	Rubber-Tak / Porcelain	2 - Side Hinge	48"W x 36"H	29 lbs	\$1,105.33
94HADC-O-RT	Rubber-Tak / Porcelain	2 - Side Hinge	48"W x 48"H	55 lbs	\$1,338.06
94HAGC-O-RT	Rubber-Tak / Porcelain	2 - Side Hinge	72"W x 48"H	82 lbs	\$1,687.10

Please specify color when ordering:

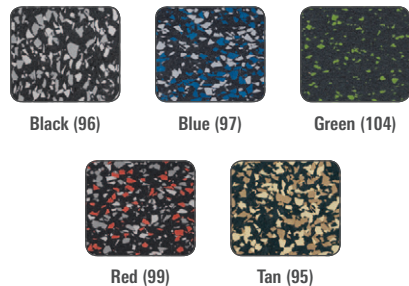



Trim Options:



Outdoor Enclosed Bulletin Board Cabinet

- » Heavy duty trim in silver or coffee aluminum frames a 1 1/2" internal depth.
- » Comes with up to three locking hinged doors with shatter-resistant acrylic panels
- » Cabinet should be mounted beneath overhang or in semi-enclosed space.
- » Made in the USA. TAA compliant.
- » Interior lighting kits available. One kit per two linear feet recommended.

Outdoor Enclosed Bulletin Board Cabinet

Silver	Coffee	Doors	Dimensions	Ship Wt.	Price (Silver)	Price (Coffee)
94PSA-0	94PCA-0	1 Hinged	24"H x 18"W	11 lbs	\$206.57	\$206.57
94PSB-0	94PCB-0	1 Hinged	36"H x 24"W	22 lbs	\$360.00	\$324.03
94PSU-0	94PCU-0	1 Hinged	36"H x 30"W	29 lbs	\$370.00	\$398.91
94PS1-0	94PC1-0	1 Hinged	36"H x 36"W	34 lbs	\$387.44	\$402.34
94PSC-0	94PCC-0	2 Hinged	36"H x 48"W	39 lbs	\$544.00	\$612.59
94PSE-0	94PCE-0	2 Hinged	36"H x 60"W	53 lbs	\$641.00	\$695.90
94PS2-0	94PC2-0	3 Hinged	36"H x 72"W	63 lbs	\$748.00	\$879.22
94PSG-0	94PCG-0	3 Hinged	48"H x 72"W	82 lbs	\$870.32	\$900.33
94PSH-0	94PCH-0	3 Hinged	48"H x 96"W	120 lbs	\$1,194.00	\$1,246.03

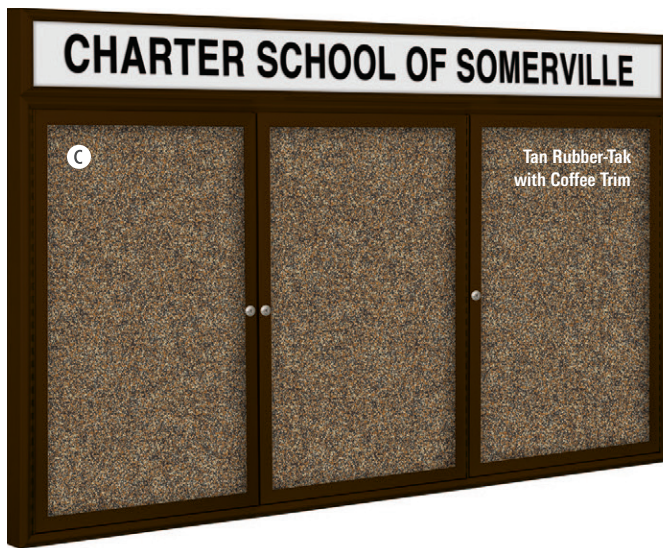

Please refer to p. 2 for a description of symbols.

Trim Options:



Outdoor Headline Bulletin Board Cabinet

- » Heavy duty trim in satin or coffee aluminum frames a 1 1/2" internal depth.
- » Includes 6" headline panel available with customized text. Call for details.
- » Cabinet should be mounted beneath overhang or in semi-enclosed space.
- » Interior lights available. One light per two linear feet recommended. See product above for details.
- » Made in the USA. TAA compliant.

Outdoor Headline Bulletin Board Cabinet

Silver	Coffee	Doors	Dimensions	Ship Wt.	Price (Silver)	Price (Coffee)
94PSA-OH	94PCA-OH	1 Hinged	30"H x 18"W	12 lbs	\$364.53	\$443.29
94PSB-OH	94PCB-OH	1 Hinged	42"H x 24"W	25 lbs	\$486.04	\$486.06
94PSU-OH	94PCU-OH	1 Hinged	42"H x 30"W	29 lbs	\$577.24	\$608.23
94PS1-OH	94PC1-OH	1 Hinged	42"H x 36"W	37 lbs	\$607.99	\$629.44
94PSC-OH	94PCC-OH	2 Hinged	42"H x 48"W	43 lbs	\$653.44	\$718.77
94PSE-OH	94PCE-OH	2 Hinged	42"H x 60"W	58 lbs	\$904.66	\$964.98
94PS2-OH	94PC2-OH	3 Hinged	42"H x 72"W	68 lbs	\$1,117.13	\$1,141.95
94PSG-OH	94PCG-OH	3 Hinged	54"H x 72"W	90 lbs	\$1,224.44	\$1,267.67
94PSH-OH	94PCH-OH	3 Hinged	54"H x 96"W	135 lbs	\$1,412.17	\$1,462.02



Ideal for posting notices, schedules, menus, or any other information outdoors!

NEW!

All Weather Herald Standing Enclosed Bulletin Board Cabinet

- » The All Weather Herald freestanding outdoor bulletin cabinet will protect your announcements from the elements.
- » Freestanding posts allow for communicating your messages in the great outdoors. Perfect for parks, college campuses, stadiums, businesses, school entrances, restaurants, and just about anywhere.
- » Acrylic glass window, porcelain steel back panel sealed with silicone, and weather stripping on all door openings prevents water from damaging contents.
- » Anodized aluminum trim and a virtually indestructible and moisture-resistant Rubber-Tak back panel withstand UV rays.
- » Cabinets come in single or double door options and a variety of sizes. Locks prevent tampering.
- » Made in the USA. TAA compliant. 5 year guarantee.



Please refer to p. 2 for a description of symbols.

All Weather Herald

Part No.	Back Panel Material	Door Style	Dimensions	Ship Wt.	Price
94HAB-OP-RT	Rubber-Tak	1 - Side Hinge	24"W x 36"H	35 lbs	\$888.27
94HACS-OP-RT	Rubber-Tak	1 - Side Hinge	36"W x 48"H	50 lbs	\$1,174.62
94HAC-OP-RT	Rubber-Tak	2 - Side Hinge	48"W x 36"H	50 lbs	\$1,360.94
94HAD-OP-RT	Rubber-Tak	2 - Side Hinge	48"W x 48"H	60 lbs	\$1,403.86
94HAF-OP-RT	Rubber-Tak	2 - Side Hinge	60"W x 48"H	75 lbs	\$1,774.91

Display Cases & Cabinets: Indoor Enclosed Directory Board Cabinets



TAA

Trim Options:

Please refer to p. 2 for a description of symbols.

Coffee

Silver

Indoor Enclosed Directory Board Cabinet

- » Durable trim frames 2" internal depth. Available in satin silver or coffee colored anodized aluminum trim.
- » Back panel is grooved black felt. Locking hinged doors prevent tampering.
- » Letter set included. Additional sets available separately.
- » Made in the USA. TAA compliant.

Indoor Enclosed Directory Board Cabinet

Silver	Coffee	Doors	Dimensions	Ship Wt.	Price (Silver)	Price (Coffee)
98PSA-I	98PCA-I	1 Hinged	24"H x 18"W	11 lbs	\$213.10	\$221.29
98PSB-I	98PCB-I	1 Hinged	36"H x 24"W	22 lbs	\$355.78	\$369.47
98PSU-I	98PCU-I	1 Hinged	36"H x 30"W	29 lbs	\$465.61	\$483.52
98PS1-I	98PC1-I	1 Hinged	36"H x 36"W	34 lbs	\$485.84	\$534.42
98PSC-I	98PCC-I	2 Hinged	36"H x 48"W	39 lbs	\$683.96	\$710.26
98PSE-I	98PCE-I	2 Hinged	36"H x 60"W	53 lbs	\$733.15	\$765.02
98PS2-I	98PC2-I	3 Hinged	36"H x 72"W	63 lbs	\$995.04	\$1,036.50
98PSG-I	98PCG-I	3 Hinged	48"H x 72"W	82 lbs	\$1,121.99	\$1,121.99
98PSH-I	98PCH-I	3 Hinged	48"H x 96"W	120 lbs	\$1,541.76	\$1,594.92

Interior Lighting Kit

Part No.	Description	Ship Wt.	Price
66568*	1 kit per 2 linear feet recommended	2 lbs	\$75.00



1 letter set included with each directory board cabinet. Choose from 3 font styles and 4 sizes.

Letter sets available on p. 86.



Please refer to p. 2 for a description of symbols.



Standard & Deluxe Directory Board Cabinets

- » The Standard Directory Board Cabinet features an internal depth of 1".
- » The Deluxe Directory Board Cabinet features an internal depth of 2".
- » Back panel is grooved black felt to hold letters securely in place.
- » Deluxe Cabinets available with either sliding or hinged doors.
- » Tempered glass doors are 3/16" thick and lock to help prevent tampering.
- » Framed with 1 3/4"W x 3"D heavy gauge anodized aluminum.
- » Cabinets include set of 300 letters and numbers. Other sets available separately.
- » Standard Directory Board Cabinets are Made in the USA. TAA compliant.

Standard Directory Board Cabinet

Part No.	Doors	Dimensions	Ship Wt.	Price
98SAB	2 Sliding	36"H x 24"W	54 lbs	\$496.78
98SAC	2 Sliding	48"H x 36"W	110 lbs	\$874.62

Deluxe Directory Board Cabinet

Part No.	Doors	Dimensions	Ship Wt.	Price
98HAB	1 Hinged Door	36"H x 24"W	54 lbs	\$525.56
98HAC	2 Hinged Doors	36"H x 48"W	110 lbs	\$929.03

Wood Trim Directory Board Cabinet

- » Durable solid oak trim available in oak or walnut stain.
- » Back panel is grooved black felt. Locking hinged doors prevent tampering.
- » Letter set included. Additional sets available separately.
- » Made in the USA. TAA compliant.

Wood Trim Directory Board Cabinet

Oak	Walnut	Doors	Dimensions	Ship Wt.	Price (Oak)	Price (Walnut)
98HWA	98HNA	1 Hinged	24"H x 18"W	11 lbs	\$169.34	\$338.67
98HWB	98HNB	1 Hinged	36"H x 24"W	22 lbs	\$263.01	\$406.47
98HWC	98HNC	2 Hinged	36"H x 48"W	39 lbs	\$449.49	\$625.38
98HWG	98HNG	3 Hinged	48"H x 72"W	82 lbs	\$1,346.39	\$1,346.39
98HWH	98HNH	3 Hinged	48"H x 96"W	120 lbs	\$1,531.13	\$1,594.93



Letter sets available on p. 86.



TAA

Trim Options:
Please refer to p. 2 for a description of symbols.



Outdoor Enclosed Directory Board Cabinet

- » Durable trim frames 2" internal depth. Available in satin silver or coffee colored aluminum.
- » Back panel is grooved black felt. Locking hinged doors prevent tampering.
- » Cabinet should be mounted beneath overhang or in semi-enclosed space.
- » Made in the USA. TAA compliant.

Outdoor Enclosed Directory Board Cabinet

Silver	Coffee	Doors	Dimensions	Ship Wt.	Price (Silver)	Price (Coffee)
98PSA-0	98PCA-0	1 Hinged	24"H x 18"W	12 lbs	\$237.52	\$247.85
98PSB-0	98PCB-0	1 Hinged	36"H x 24"W	24 lbs	\$379.32	\$396.57
98PSU-0	98PCU-0	1 Hinged	36"H x 30"W	34 lbs	\$496.41	\$518.97
98PS1-0	98PC1-0	1 Hinged	36"H x 36"W	38 lbs	\$612.16	\$612.16
98PSC-0	98PCC-0	2 Hinged	36"H x 48"W	44 lbs	\$729.20	\$729.20
98PSE-0	98PCE-0	2 Hinged	36"H x 60"W	58 lbs	\$803.28	\$803.28
98PS2-0	98PC2-0	3 Hinged	36"H x 72"W	69 lbs	\$1,044.79	\$1,044.79
98PSG-0	98PCG-0	3 Hinged	48"H x 72"W	90 lbs	\$1,229.31	\$1,229.31
98PSH-0	98PCH-0	3 Hinged	48"H x 96"W	130 lbs	\$1,607.68	\$1,607.68



Please refer to p. 2 for a description of symbols.

Trim Options:

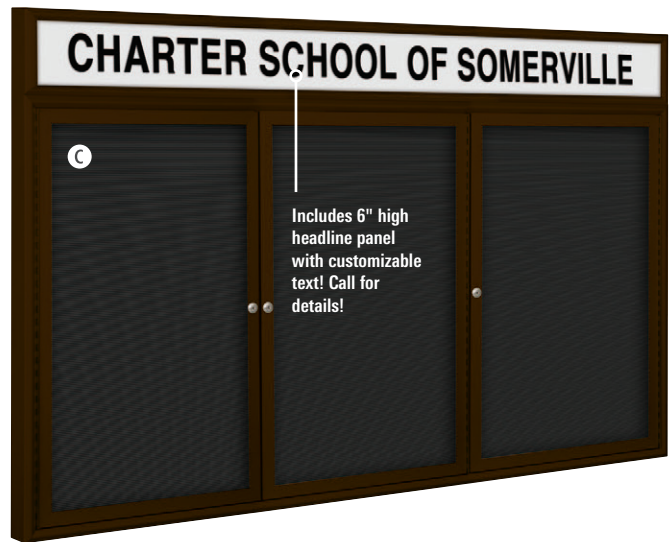
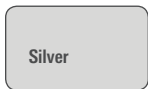

Includes 6" high headline panel with customizable text! Call for details!

Outdoor Headline Directory Board Cabinet

- » Heavy duty trim in satin or coffee aluminum frames a 2" internal depth.
- » Locking hinged doors protects messages and prevent tampering. Includes a 6" headliner panel with customizable text. Call for details.
- » Cabinet should be mounted beneath overhang or in semi-enclosed space.
- » Letter set included. Additional sets available separately.
- » Made in the USA. TAA compliant.

Outdoor Headline Directory Board Cabinet

Silver	Coffee	Doors	Dimensions	Ship Wt.	Price (Silver)	Price (Coffee)
98PSA-OH	98PCA-OH	1 Hinged	30"H x 18"W	14 lbs	\$363.51	\$479.17
98PSB-OH	98PCB-OH	1 Hinged	42"H x 24"W	27 lbs	\$551.74	\$606.91
98PSU-OH	98PCU-OH	1 Hinged	42"H x 30"W	38 lbs	\$722.05	\$794.26
98PS1-OH	98PC1-OH	1 Hinged	42"H x 36"W	42 lbs	\$979.45	\$979.45
98PSC-OH	98PCC-OH	2 Hinged	42"H x 48"W	48 lbs	\$1,060.66	\$1,060.66
98PSE-OH	98PCE-OH	2 Hinged	42"H x 60"W	64 lbs	\$1,285.24	\$1,285.24
98PS2-OH	98PC2-OH	3 Hinged	42"H x 72"W	77 lbs	\$1,671.67	\$1,671.67
98PSG-OH	98PCG-OH	3 Hinged	54"H x 72"W	99 lbs	\$1,966.89	\$1,966.89
98PSH-OH	98PCH-OH	3 Hinged	54"H x 96"W	145 lbs	\$2,143.57	\$2,143.57

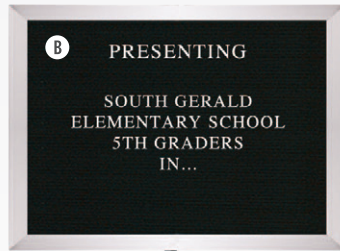

49"
to
66"



Standing Directory Board Cabinet

- » Coffee aluminum trim includes base designed for stability.
- » Unit measures 68"H. Letterboard surface measures 36"H x 30"W.
- » Locking hinged door with acrylic panel.
- » Includes set of letters and numbers. Additional sets available separately.

A Standing Directory Board Cabinet			
Part No.	Dimensions	Ship Wt.	Price
98UJZ	68"H x 35"W	58 lbs	\$398.00

Single Pedestal Directory Board

- » Sturdy base is height adjustable from 49" to 66" and is easily maneuvered.
- » Available open-face or with shatter-resistant clear acrylic panel.
- » Grooved felt letterboard available in black and measures 24"W x 18"H.
- » Each unit comes with standard set of plastic letters. Additional sets available separately.

B Single Pedestal Directory Board			
Part No.	Dimensions	Ship Wt.	Price
980AA	49"-66"H x 24"W	18 lbs	\$203.48
C Single Pedestal Directory Board - w/Acrylic Panel			
Part No.	Dimensions	Ship Wt.	Price
98CAA	49"-66"H x 24"W	23 lbs	\$221.32

Twin Pedestal Directory Board

- » Twin black anodized aluminum pedestals add stability.
- » Mobile unit measures 66"H.
- » Letterboard surface measures 18" x 24".
- » Includes set of letters and numbers. Additional sets available separately.

D Twin Pedestal Directory Board			
Part No.	Dimensions	Ship Wt.	Price
98PAA	66"H x 24"W	25 lbs	\$178.36



1 letter set included with each directory board cabinet. Choose from 3 font styles and 4 sizes.

E Letter Sets						
Gothic 1/2"	Gothic 3/4"	Gothic 1"	Gothic 1 1/2"	Gothic 2"	Ship Wt.	Price
96G-R1*	96G-R2*	96G-R3*	96G-R4*	n/a	2 lbs	\$28.00
Helvet 1/2"	Helvet 3/4"	Helvet 1"	Helvet 1 1/2"	Helvet 2"	Ship Wt.	Price
96H-R1*	96H-R2*	96H-R3*	96H-R4*	n/a	2 lbs	\$35.00
Roman 1/2"	Roman 3/4"	Roman 1"	Roman 1 1/2"	Roman 2"	Ship Wt.	Price
96L-R1*	96L-R2*	96L-R3*	n/a	96L-R5*	2 lbs	\$42.00

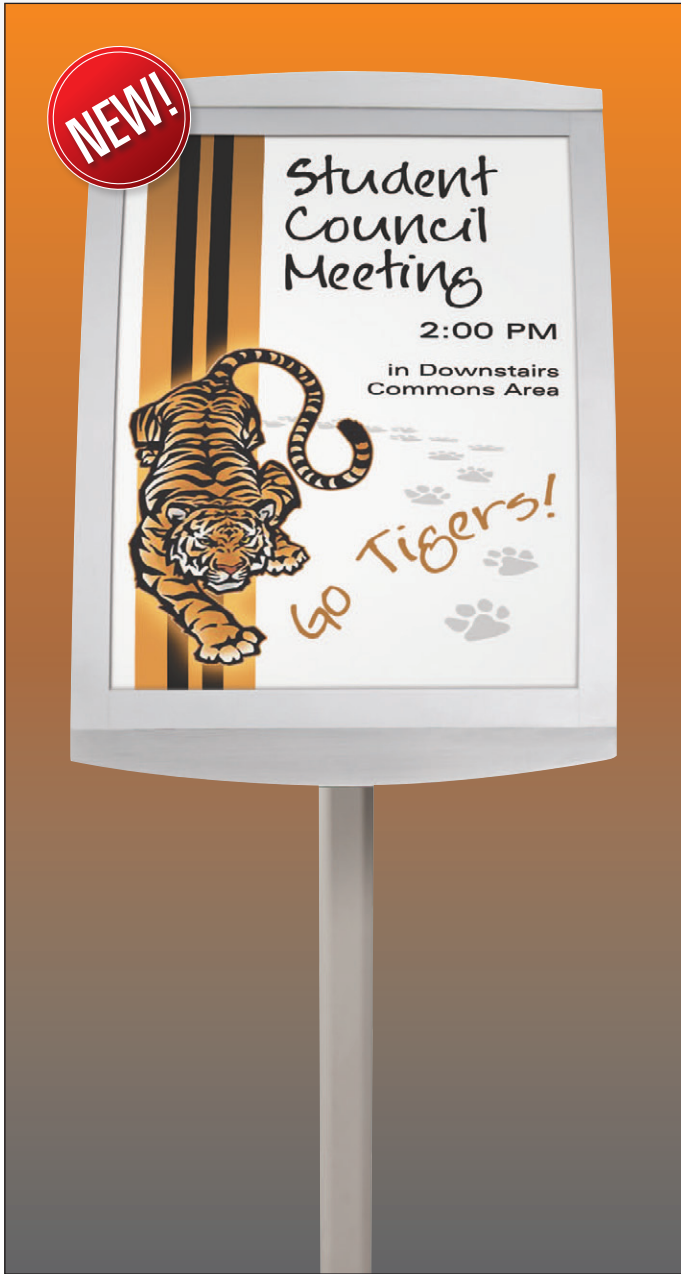

NEW!

Flexible magnetic sheet protector holds up to 11" x 17" sign!



**Navigator
Floor Sign Stand**



Please refer to p. 2 for a description of symbols.

- » Display your message anytime, anywhere with the Navigator Floor Sign Stand. Perfect for restaurants, lobbies, and store fronts.
- » Simple magnetic, non-glare sheet protector holds any standard 11"x 17" graphic in place and keeps it protected from dust, dirt, and damage.
- » The Navigator Floor Sign has a sturdy, modern design that stands just under 5 feet tall.

A Navigator Floor Sign Stand				
Part No.	Description	Dimensions	Ship Wt.	Price
45851	Navigator Floor Stand Sign	57 1/2"H x 14"W x 18"D	17 lbs	\$117.60



Please refer to p. 2 for a description of symbols.

Wall Mount Display Case

- » The Wall Mount Display Case shows your collectibles and valuables with style.
- » Features 3/16" thick tempered glass on three sides, allowing maximum visibility.
- » Doors lock to help prevent tampering.
- » Framed in elegant rounded black anodized aluminum Elite trim.
- » Back panel is available in black, walnut, oak, or silver hook and loop fabric. Custom laminates and back panels are also available.
- » Made in the USA. TAA compliant. 4' X 4' case is Quick Ship in standard laminates.



Oak (10)

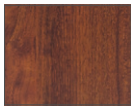

Walnut (11)



Black (14)



Wall Mount Display Case

Part No.	Dimensions	Ship Wt.	Price
90W83	4'H x 3'W x 16"D	250 lbs	\$2,093.57
90W84	4'H x 4'W x 16"D	340 lbs	\$2,409.48
90W85	4'H x 5'W x 16"D	450 lbs	\$2,720.31
90W86	4'H x 6'W x 16"D	550 lbs	\$3,059.10



Please refer to p. 2 for a description of symbols.

Counter Height Display Case

- » The Counter Height Display Case displays your awards or other valuables in style.
- » Includes glass top, sliding locking glass doors, and one adjustable glass shelf.
- » Frame is black cast aluminum Elite trim with rounded corners for safety.
- » Cabinet available with a full view glass back, or with a closed back and base.
- » Choose from solid black, walnut, or oak laminate panels. Custom laminates available.
- » Made in the USA. TAA compliant.



C Full View



Oak (10)



Walnut (11)



Black (14)



B Closed Base

Counter Height Display Case - Closed Base

Part No.	Dimensions	Ship Wt.	Price
98B83	40"H x 36"W x 14"D	205 lbs	\$1,744.80

Counter Height Display Case - Full View

Part No.	Dimensions	Ship Wt.	Price
98C83	40"H x 36"W x 14"D	205 lbs	\$1,744.80



Qs **TAA** Please refer to p. 2 for a description of symbols.

Elite Freestanding Display Case

- » The Elite Freestanding Display Case exhibits trophies, collectibles, and other valuables.
- » Frame is made of black anodized aluminum with elegant rounded corners
- » Locking sliding doors and adjustable shelves are made of 3/16" thick tempered glass.
- » Laminate back panel is available standard in black, oak, or walnut.
- » Custom laminates and custom cabinet sizes are also available.
- » Available with an optional cornice and light set to illuminate items on display.
- » Made in the USA. TAA compliant.
- » Quick Ship in standard laminates. Ships within 7 days of order.

A Elite Freestanding Display Case - Standard			
Part No.	Dimensions	Ship Wt.	Price
93R84	5 1/2"H x 4"W x 1 1/2"D	320 lbs	\$2,914.87
93R85	5 1/2"H x 5"W x 1 1/2"D	425 lbs	\$3,027.61
93R86	5 1/2"H x 6"W x 1 1/2"D	480 lbs	\$3,425.41

B Elite Freestanding Display Case - w/lighting			
Part No.	Dimensions	Ship Wt.	Price
93C84	6"H x 4"W x 1 1/2"D	420 lbs	\$3,217.92
93C85	6"H x 5"W x 1 1/2"D	485 lbs	\$3,665.01
93C86	6"H x 6"W x 1 1/2"D	550 lbs	\$4,080.00



Qs **TAA** Please refer to p. 2 for a description of symbols.

Traditional Wood Display Case

- » The Traditional Wood Display Case provides a beautiful medium to showcase valuables.
- » Wood-framed hinged doors feature a tamper-proof lock to secure cabinet contents.
- » Side and door panels are made from 3/16" thick tempered glass.
- » Three 3/16" thick tempered glass shelves adjust in three different positions.
- » Available with your choice of an oak or mahogany finish.
- » Optional brass plate (2 1/4"H x 5 1/2"W) with up to three lines of free engraving is available.
- » May be TAA compliant.

D Optional brass plate



C Traditional Wood Display Case			
Part No.	Dimensions	Ship Wt.	Price
97CWO (Oak)	77"H x 48"W x 18"D	350 lbs	\$1,917.84
97CWC (Mah)	77"H x 48"W x 18"D	350 lbs	\$1,917.84

D Optional Engraved Brass Plate			
Part No.	Dimensions	Ship Wt.	Price
901	2 1/4"H x 5 1/2"W	1 lb	\$100.00

NEW!

Available with 3 different projector arms. See opposite page for technical details.



Projector arms have been stability tested up to 25 lbs at full extension!

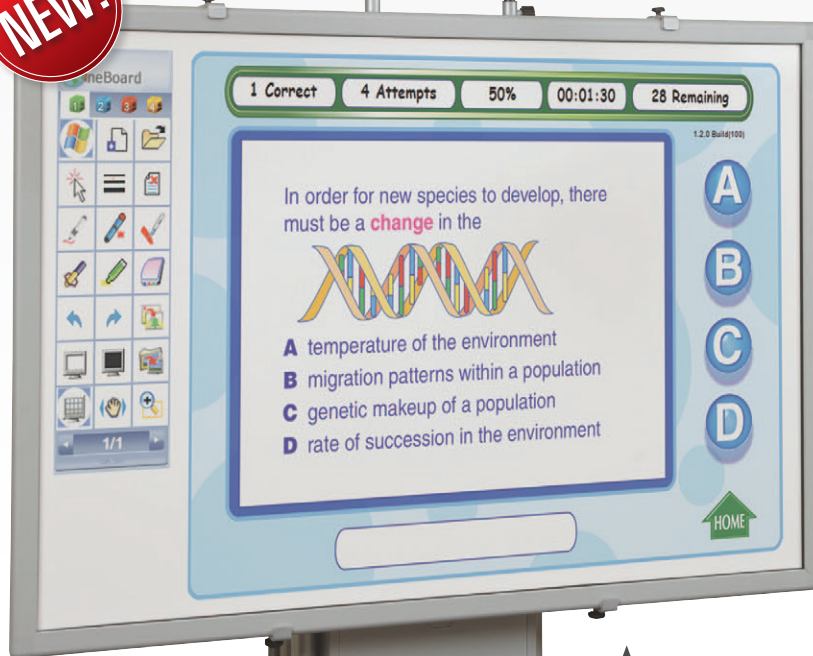

D Optional sidwing table for laptop and document camera.



Accommodates a board up to 2" thick.

Shown with OneBoard™ Interactive Whiteboard, see pp. 18-19.

20" of electrical height adjustment.

E Optional Locking Cabinet

Pat. Pending



iTeach™ 2 shown without board.



Please refer to p. 2 for a description of symbols.

iTeach™ 2 Mobile Electric Interactive Whiteboard Stand

- » Engage your audience anywhere with the iTeach™ 2 Mobile Electric IWB stand, a streamlined version of the original, giving any interactive whiteboard mobility and height adjustability.
- » UL-approved electric system allows for 20" of smooth height adjustment from 12" at the bottom to 84" at the top with a simple touch of a button on the hand held control pad.
- » Meets ADA requirements and Architectural Barriers Act Accessibilities guidelines.
- » Sold as a package with either a short throw projector arm, super short throw projector arm, or ultra short throw projector arm. See diagram on opposite page for arm specifications.
- » Optional electrical assembly with seven outlets, 25' cord and winder available.
- » TAA compliant.



See product video online!
youtube.com/moorecoinc

* Note: The iTeach™ 2 Mobile Electric Interactive Whiteboard Stand does not include whiteboard.



iTeach™ 2 reverse side, shown without board.

Space for the optional locking cabinet or a desktop CPU.

Choose your ideal projector arm:

Specify the arm you need when ordering.

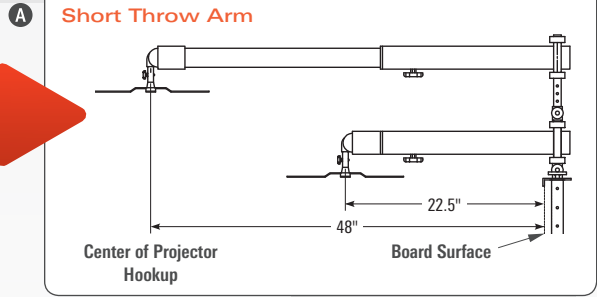

Electrical height adjustment works with nearly every interactive whiteboard.

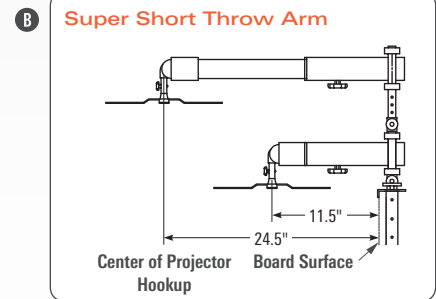

▲ Shelf accommodates small to medium sized printers.

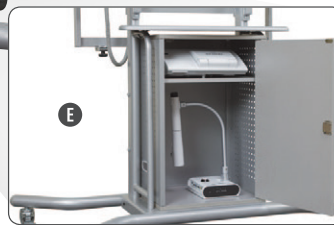
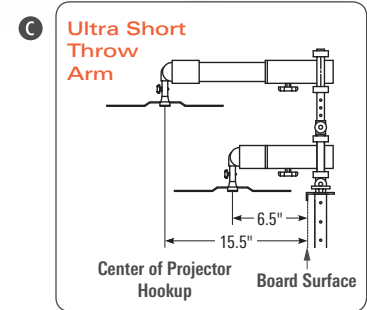

Optional locking cabinet. ▲



The iTeach™ height adjustment meets ADA requirements, making it perfect for small or disabled users.

A iTeach™ 2 - Short Throw Arm			
Part No.	Dimensions	Ship Wt.	Price
■ 27634	75"-100"H x 55 3/4"W x 30"D	215 lbs	Call

B iTeach™ 2 - Super Short Throw Arm			
Part No.	Dimensions	Ship Wt.	Price
■ 27635	75"-100"H x 55 3/4"W x 30"D	212 lbs	Call

C iTeach™ 2 - Ultra Short Throw Arm			
Part No.	Dimensions	Ship Wt.	Price
■ 27636	75"-100"H x 55 3/4"W x 30"D	210 lbs	Call

D Optional Sidewing Table			
Part No.	Dimensions	Ship Wt.	Price
■ 66615	3 Outlet / 25' cord	17 lbs	Call

E Optional Locking Cabinet			
Part No.	Dimensions	Ship Wt.	Price
■ 66614	Optional Locking Cabinet	45 lbs	Call

F Electrical Assembly			
Part No.	Dimensions	Ship Wt.	Price
■ 66572*	7 Outlet / 25' cord / winder	8 lbs	Call

Available with 3 different projector arms. See opposite page for technical details.

Projector arms have been stability tested up to 25 lbs at full extension!



A



Elevation™ Wall Mount available separately, see p. 95.

D Optional sidewing table for laptop and document camera. ▼

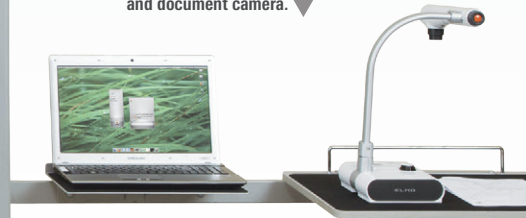

18" of pneumatic height adjustment.



Elevation™ Mobile Stand is also available with Flat Panel Mount, see p. 96.

Space for the optional locking cabinet or a desktop CPU.

Whiteboard not included. Shown with OneBoard™ Interactive Whiteboard, see pp. 18-19.

Pat. Pending



Please refer to p. 2 for a description of symbols.

Elevation™ Mobile Stand with Elevation™ Wall Mount

- » Add 18" of pneumatic height adjustment and mobility to almost any board with the Elevation™ Mobile Stand with Elevation™ Wall Mount. Mount holds up to 4'H x 8'W x 5"D board between 50-100 lbs.
- » Brushed silver frame is attractive, durable, and adds storage for your computer and other AV equipment. Moves easily from room to room on heavy duty locking casters.
- » Projector arm included. Choose from short throw, super short throw, or ultra short throw. See page two for technical specifications. Holds up to 25 lb. projector.
- » Optional adjustable sidewing table keeps your laptop within arm's reach. Optional cabinet available for secure storage. Optional electrical assembly available.
- » TAA compliant. GREENGUARD Indoor Air Quality Certified® and GREENGUARD Children & Schools CertifiedSM.



Elevation™ Mobile Stand shown without board.

* Note: The Elevation™ Mobile Pneumatic Interactive Whiteboard Stand does not include whiteboard.



Choose your ideal projector arm:

Specify the arm you need when ordering.

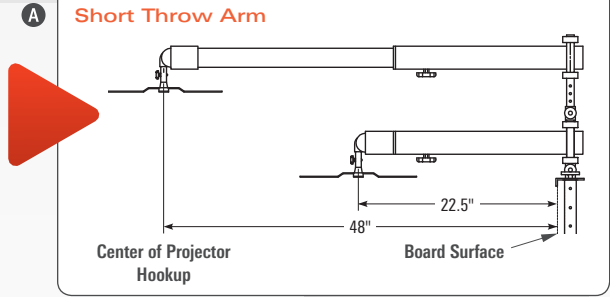

Elevation™ Mobile Stand reverse side.

Pneumatic height adjustment works with nearly every interactive whiteboard.

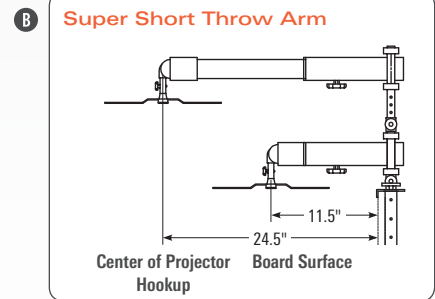

▲ Shelf accommodates small to medium sized printers.

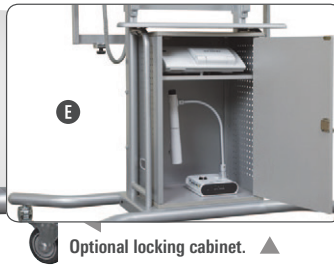
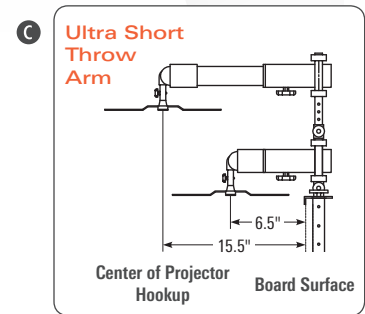

Know Your Throw!

To optimize your projection of imagery, make sure the throw arm you order will be compatible with the make and model of your projector. Since there are so many types of throw projectors, we recommend consulting your projector user manual or website before ordering.

A Elevation™ Mobile Stand - Short Throw Arm				
Part No.	Dimensions	Ship Wt.	Price	
27639	75"-98"H x 55 3/4"W x 30"D	212 lbs	Call	
B Elevation™ Mobile Stand - Super Short Throw Arm				
Part No.	Dimensions	Ship Wt.	Price	
27640	75"-98"H x 55 3/4"W x 30"D	209 lbs	Call	
C Elevation™ Mobile Stand - Ultra Short Throw Arm				
Part No.	Dimensions	Ship Wt.	Price	
27641	75"-98"H x 55 3/4"W x 30"D	207 lbs	Call	

D Optional Sidewing Table				
Part No.	Dimensions	Ship Wt.	Price	
66615	3 Outlet / 25' cord	17 lbs	Call	
E Optional Locking Cabinet				
Part No.	Dimensions	Ship Wt.	Price	
66614	Optional Locking Cabinet	45 lbs	Call	
F Electrical Assembly				
Part No.	Dimensions	Ship Wt.	Price	
66572*	7 Outlet / 25' cord / winder	8 lbs	Call	

■ In Stock: ships within 48 hours of order. ■ Quick Ship: ships within 7 days of order.
*Ships UPS. **Ships UPS + \$9.00 handling fee.



◀ Throw arms have been stability tested up to 25 lbs at full extension!

NEW!

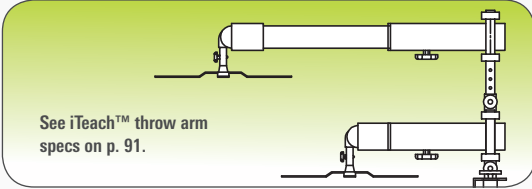

Electric motors are controlled via handheld remote.



↕ 20" of electrical height adjustment.

Accommodates a board up to 5" thick!

Whiteboard not included with iTeach wall mount.

See New OneBoard™ Interactive Whiteboard on pp. 18-19!

Pat. Pending



Please refer to p. 2 for a description of symbols.



iTeach™ Electric Wall Mount

- » Address your audience's needs by adding 20" of electric height adjustment to any board with the iTeach™ Wall Mount.
- » Attach the mount wherever needed on your wall to allow easy accessibility. With just one touch of a button on the hand held control pad, the wall mount will glide effortlessly to the desired height.
- » Holds up to a 4'H x 8'W board between 50 and 100 lbs and up to 5" thick.
- » Projector arm included. Choose from short throw, super short throw, or ultra short throw. See p. 91 for technical specifications. Holds up to 25 lb. projector.
- » Platinum powder-coat finish is attractive and durable.
- » TAA compliant.

● iTeach™ Electric Wall Mount - Short Throw Arm			
Part No.	Dimensions	Ship Wt.	Price
■ 27631	63 1/2"H x 55 1/2"W x 8 1/4"D	119 lbs	Call
● iTeach™ Electric Wall Mount - Super Short Throw Arm			
Part No.	Dimensions	Ship Wt.	Price
■ 27632	63 1/2"H x 55 1/2"W x 8 1/4"D	117 lbs	Call
● iTeach™ Electric Wall Mount - Ultra Short Throw Arm			
Part No.	Dimensions	Ship Wt.	Price
■ 27633	63 1/2"H x 55 1/2"W x 8 1/4"D	115 lbs	Call

* Note: The iTeach™ Electric Wall Mount armature does not include whiteboard.



Perfect for use with an interactive whiteboard, or use without projector arm for a standard whiteboard.

18" of pneumatic height adjustment.

Accommodates a board up to 5" thick!



Please refer to p. 2 for a description of symbols.

Elevation™ Wall Mount

- » Add 18" of pneumatic height adjustment to any board with the Elevation™ Wall Mount.
- » Attach the mount wherever needed on your wall to allow easy accessibility. Holds up to a 4'H x 8'W board between 50 and 100 lbs and up to 5" thick. Platinum powder-coat finish is attractive and durable.
- » Projector arm included. Choose from short throw, super short throw, or ultra short throw. See page two for technical specifications. Holds up to 25 lb. projector. See p. 93 for info.
- » Includes adapter for use with universal mounts.
- » TAA compliant. GREENGUARD Indoor Air Quality Certified® and GREENGUARD Children & Schools CertifiedSM.

Part No.	Dimensions	Ship Wt.	Price
27620	57-75"H x 29"W x 8"D	87 lbs	Call
27621	57-75"H x 29"W x 8"D	85 lbs	Call
27622	57-75"H x 29"W x 8"D	83 lbs	Call

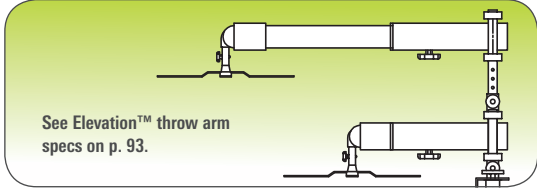



Supports up to a 55"/100 lb display.

B Optional Locking Cabinet

Bracket tilts for optimum viewing angle.



Bracket mounts at two heights: 43" or 59" on center.



www.moorecoinc.com/green for detailed information.



Please refer to p. 2 for a description of symbols.



Optional locking cabinet.

Elevation™ Mobile Stand with Flat Panel Mount

- » Elevation™ Mobile Stand with Flat Panel Mount offers mobility and flexibility for your large flat panel display. Moves easily from room to room on heavy duty locking casters.
- » Brushed silver frame is attractive, durable, and adds storage for your DVD player or computer.
- » Stand is fixed height, but flat panel mount can be mounted at two different heights (43" or 59" on center; please note overall height and clearance will vary with model of TV). Mount also tilts for optimum visibility.
- » Optional cabinet available for secure storage. Optional electrical assembly available.
- » Stand is GREENGUARD Indoor Air Quality Certified® and GREENGUARD Children & Schools CertifiedSM.

A Elevation™ Mobile Stand with Flat Panel Mount			
Part No.	Dimensions	Ship Wt.	Price
27650	72"H x 55 3/4"W x 30"D	155 lbs	\$911.69
B Optional Locking Cabinet			
Part No.	Dimensions	Ship Wt.	Price
66614	26 1/2"H x 17 3/4"W x 15 1/2"D	45 lbs	\$329.82
C Electrical Assembly			
Part No.	Dimensions	Ship Wt.	Price
66572*	7-outlet / 25' cord / winder	8 lbs	\$88.00



Supports up to a 50"/100 lb display.

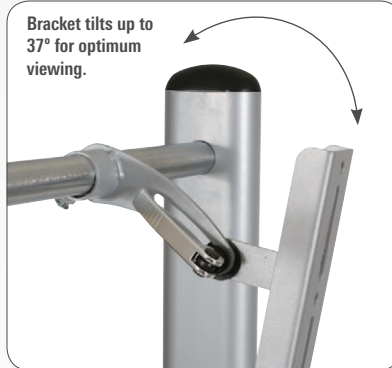

Bracket tilts up to 37° for optimum viewing.



Please refer to p. 2 for a description of symbols.

Platinum Flat Panel Stand

- » The Platinum Flat Panel Stand features a modern design to accommodate the new generation of flat panel displays.
- » GREENGUARD Indoor Air Quality Certified® and GREENGUARD Children & Schools CertifiedSM.
- » Holds up to a 50"/100 lb display and tilts up to 37°.
- » AV shelf (32"W x 14"D) is scratch-resistant gray laminate. Perforated steel panel beneath shelf.
- » Frame is silver powder-coated steel with heavy duty 5" casters (two locking).
- » TAA compliant.

A Platinum Flat Panel Stand			
Part No.	Dimensions	Ship Wt.	Price
■ 27544	67"H x 35"W x 25 1/2"D	75 lbs	\$747.92



See coordinating Platinum Reversible Boards on p. 62!

B Larger mount for screens up to 61"



Standard mount supports up to a 42"/80 lb display.

Larger mount supports a 42"-61"/100 lb display.



Tilt display up to 30°.

Shelf for DVD player or other equipment.

18 gauge steel support post includes hidden wire management conduits.

Wide base design provides stability while keeping a small footprint.

HPL shelves

Heavy duty 4" urethane casters.

Optional video conference shelf.



D Optional game/storage cabinet.



Please refer to p. 2 for a description of symbols.

Mobile Flat Panel Stand

- » The Mobile Flat Panel Stand provides stability and portability flat panel displays. GREENGUARD Indoor Air Quality Certified® and GREENGUARD Children & Schools CertifiedSM.
- » Standard mount holds up to a 42"/80 lb flat panel display. Larger mount holds a 42"-61"/100 lb display. Tilts up to 30°.
- » Frame is finished with a brushed metal powder-coated steel.
- » Tested to hold 100 lbs without tipping!
- » AV shelf measures 18"W x 14"D. Base shelf measures 2 1/2"H x 30 1/2"W x 29 1/2"D and is designed to protect against tipping. Includes 4" urethane swivel casters (two locking).
- » Optional video conferencing shelf holds a video camera for convenient teleconferencing.

A Mobile Flat Panel Stand - Standard Mount			
Part No.	Dimensions	Ship Wt.	Price
27542	66 1/2"H x 30 1/2"W x 29 1/2"D	105 lbs	\$1,029.85
B Mobile Flat Panel Stand - Large Mount			
Part No.	Dimensions	Ship Wt.	Price
27638	66 1/2"H x 30 1/2"W x 29 1/2"D	105 lbs	Call
C Video Conference Shelf			
Part No.	Dimensions	Ship Wt.	
66588*	9 1/2" - 14 1/2"H x 6"W x 8 1/2"D	5 lbs	\$50.00
D Game/Storage Cabinet			
Part No.	Dimensions	Ship Wt.	
34633*	22"H x 22"W x 19"D	45 lbs	\$293.00



Bracket tilts up to 30° for optimum viewing.

A Black Cherry



Find out more online!
youtube.com/moorecoinc

See the complete line of Lumina™ furnishings on pages 12-15!



Please refer to p. 2 for a description of symbols.

Lumina™ Flat Panel Stand

- » The elegant Lumina™ Flat Panel Stand adds elegance to any audio/visual environment. Available in platinum or black cherry.
- » Mounting bracket is angle adjustable and height adjustable from 62 3/4" to 80 1/4". Holds up to 42" display.
- » AV shelf (23 1/2"W x 15"D) in antimicrobial powder-coated MDF (platinum frame) or in rich cherry woodgrain laminate (black frame). Frame is powder-coated steel with 3" casters (2 locking).
- » Platinum carries limited lifetime warranty.



Supports up to a 42"/80 lb display.

A Platinum

62 3/4"
to
80 1/4"



Scan this QR code to watch this product's online video.

Base design provides stability.

Lumina™ Flat Panel Stand				
Part No.	Color	Dimensions	Ship Wt.	Price
27561	Platinum	62 3/4" - 80 1/4"H x 25"W x 27 3/4"D	75 lbs	\$570.00
27579	Black Cherry	62 3/4" - 80 1/4"H x 25"W x 27 3/4"D	75 lbs	\$570.00

H-style mounting bracket includes wire management channels and is height adjustable.



Supports up to a 54"/100 lb flat panel display.

Two fully retractable equipment shelves.

16 gauge steel posts

18 gauge steel panels

Wide body design provides exceptional stability.

Spacious locking storage cabinet.



Please refer to p. 2 for a description of symbols.

Wide Body Flat Panel Cart with Cabinet

- » The Wide Body Flat Panel Cart is exceptionally stable for larger (up to 54"/100 lb) flat panel displays.
- » GREENGUARD Indoor Air Quality Certified® and GREENGUARD Children & Schools CertifiedSM.
- » Mounting bracket is height adjustable. Posts feature cable conduits. Spacious locking storage cabinet. Black powder-coated steel frame includes 4" swivel casters (2 locking).
- » Electrical assembly with four outlets, a 25' cord, and cord winder included.
- » 10 year guarantee.



A Wide Body Flat Panel Cart with Cabinet			
Part No.	Dimensions	Ship Wt.	Price
27531	67"H x 32"W x 28"D	110 lbs	\$972.00



Supports up to a 44"/80 lb flat panel display.

H-style mounting bracket includes wire management channels and is height adjustable.



Please refer to p. 2 for a description of symbols.

Wide Body Flat Panel Cart

- » The Wide Body Flat Panel Cart is exceptionally stable for larger (up to 44"/80 lb) flat panel displays.
- » GREENGUARD Indoor Air Quality Certified® and GREENGUARD Children & Schools CertifiedSM.
- » Mounting bracket is height adjustable. Posts feature cable conduits. Black powder-coated steel frame includes 4" swivel casters (2 locking).
- » Electrical assembly with four outlets, a 25' cord, and cord winder included.
- » 10 year guarantee.



A Wide Body Flat Panel Cart

Part No.	Dimensions	Ship Wt.	Price
■ 27553	67"H x 32"W x 23 1/2"D	68 lbs	\$608.00



Supports up to a 42"/80 lb display.



Two height adjustable retractable shelves.



Please refer to p. 2 for a description of symbols.

Height Adjustable Flat Panel Cart

- » The all-steel Height Adjustable Flat Panel Cart supports a flat panel display up to 42"/80 lbs.
- » GREENGUARD Indoor Air Quality Certified® and GREENGUARD Children & Schools CertifiedSM.
- » The bracket can be height adjusted in 1" increments. Top shelf is also height adjustable.
- » Two retractable shelves provide equipment storage, and slide beneath the surface.
- » Includes spacious locking storage cabinet (15"H x 24"W x 18"D). Includes 4" swivel casters (two locking)
- » UL/CSA approved electrical assembly with four outlets and a 25' cord is included.



www.moorecoinc.com/green for detailed information.

Four-outlet electrical assembly included.

B Height Adjustable Flat Panel Cart

Part No.	Dimensions	Ship Wt.	Price
■ 27530	46"-62"H x 24"W x 18"D	85 lbs	\$1,002.74



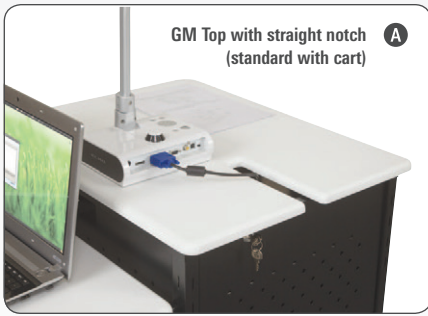

Retracting document camera shelf.



Please refer to p. 2 for a description of symbols.

Optima GM & EM Document Camera Security Carts

- » The Optima document camera security cart is your hub for laptop, mouse, document camera, projector, and other AV equipment on one, stable platform.
- » Compact footprint and heavy duty casters allow easy movement through aisles, doorways and cramped media areas.
- » Doors and hatches on all sides allow easy accessibility, and lock for security. Locking top shelf slot allows you to secure even the tallest document camera.
- » Height-adjustable side shelf can be hung vertically when not in use. Change from a sitting to a standing position whenever you want as you teach or work. Optional second side shelf available separately.
- » Grommets on either side of the cart provide cable management for electronics on the outer shelves.
- » Optional EM top available to fit other document camera models.
- » Optional electrical assembly mounts either inside or outside for additional security.

Optima EM Cart shown with Optional Shelf.



A Optima GM - Cart and Top			
Part No.	Dimensions	Ship Wt.	Price
■ 27623	40"H x 21 1/4"W x 30 1/2"D	95 lbs	\$963.52
B Optima EM - Top Only			
Part No.	Dimensions	Ship Wt.	Price
■ 27642	21 1/4"W x 30 1/2"D	10 lbs	\$58.01
C Optional GM/EM Shelf			
Part No.	Dimensions	Ship Wt.	
■ 34724		10 lbs	\$55.58
D Electrical Assembly			
Part No.	Dimensions	Ship Wt.	
■ 66572*	7-outlet / 25' cord / winder	8 lbs	\$88.00





Includes 2 adjustable shelves.

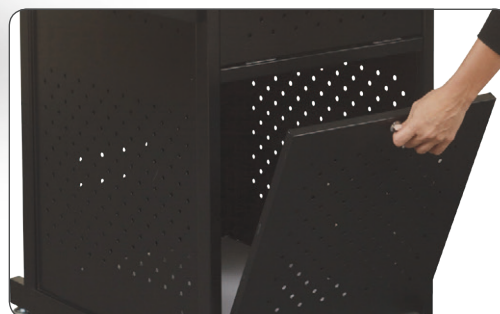

Spacious storage compartment below.



Please refer to p. 2 for a description of symbols.

Optima LM Document Camera Security Cart

- » The Optima LM document camera security cart is your hub for laptop, mouse, document camera, projector, and other AV equipment on one, stable platform.
- » Compact footprint and heavy duty casters allow easy movement through aisles, doorways and cramped media areas.
- » Doors and hatches on all sides allow easy accessibility, and lock for security. Locking top shelf slot allows you to secure even the tallest document camera.
- » Height-adjustable side shelves can be hung vertically when not in use. Change from a sitting to a standing position whenever you want as you teach or work.
- » Grommets on either side of the cart provide cable management for electronics on the outer shelves.
- » Optional electrical assembly mounts either inside or outside for additional security.

A Optima LM - Cart and Top			
Part No.	Dimensions	Ship Wt.	Price
27643	43"H x 21 1/4"W x 30 1/2"D	95 lbs	\$1,027.32
B Electrical Assembly			
Part No.	Dimensions	Ship Wt.	
66572*	7-outlet / 25' cord / winder	8 lbs	\$88.00

A Gray



Choose gray or teak woodgrain laminate.
Specify color when ordering.

A Teak



Laptop shelf is height adjustable.



Please refer to p. 2 for a description of symbols.

Presentation Cart

- » The Presentation Cart provides AV equipment space and storage in one compact unit. GREENGUARD Indoor Air Quality Certified® and GREENGUARD Children & Schools CertifiedSM.
- » Black powder-coated steel frame includes 3" casters. Optional 5" casters are available.
- » Top shelf and laptop shelf are 18"W x 14"D. Laptop shelf adjusts from 19" to 39 1/2"H. Bottom shelf measures 18"W x 18"D. Optional shelf (18"W x 14"D) mounts below the laptop shelf and is also height adjustable.
- » Locking three-shelf cabinet (20"H x 14"W x 15"D) is available. Optional electrical assemblies available.
- » TAA compliant. 10 year guarantee.

A Presentation Cart

Part No.	Color	Dimensions	Ship Wt.	Price
89759	Gray	40 1/4"H x 18"W x 30"D	46 lbs	\$330.00
27519	Teak	40 1/4"H x 18"W x 30"D	46 lbs	\$330.00

B Optional Shelf

Part No.	Color	Dimensions	Ship Wt.	Price
34405*	Gray	18"W x 14"D	10 lbs	\$43.00
34458*	Teak	18"W x 14"D	10 lbs	\$46.00

C Optional Locking Cabinet

Part No.	Color	Dimensions	Ship Wt.	Price
34409*	Gray	20"H x 14"W x 15"D	40 lbs	\$197.00
34459*	Teak	20"H x 14"W x 15"D	40 lbs	\$197.00

D Electrical Assembly

Part No.	Description	Ship Wt.	Price
66450*	4-outlet / 25'cord / winder	4 lbs	\$62.00
66572*	7-outlet / 25'cord / winder	8 lbs	\$88.00

E Optional Larger Casters

Part No.	Dimensions	Ship Wt.	Price
66577	5" diameter	6 lbs	\$64.00





A Gray

Vacuum-formed PVC shelves



See product video online!
youtube.com/moorecoinc

18 gauge steel panels

Now available in all Black finish!



A Black

Laptop shelf is height adjustable.



C



B



Scan this QR code to watch this product's online video.



Please refer to p. 2 for a description of symbols.

Xtra Wide Presentation Cart

- » The Xtra Wide Presentation Cart comes standard with four shelves in gray or black.
- » GREENGUARD Indoor Air Quality Certified® and GREENGUARD Children & Schools CertifiedSM.
- » Laptop shelf is height adjustable. Optional shelf mounts to the front or either side of cart. Black powder-coated steel frame includes 4" casters (two locking).
- » Optional locking cabinet available. Includes rack mount for standard 19" rack equipment. Optional electrical assemblies available.
- » May be available as TAA. Please call for details. 10 year guarantee.

ⓐ Xtra Wide Presentation Cart

Gray	Black	Dimensions	Ship Wt.	Price (Gray)	Price (Black)
■ 27517	■ 27596	40"H x 21 1/4"W x 30 1/2"D	95 lbs	\$571.20	\$544.00

ⓑ Optional Shelf

Gray	Black	Dimensions	Ship Wt.	Price (Gray)	Price (Black)
■ 34444*	■ 66611*	18"W x 24 3/4"D	10 lbs	\$61.95	\$91.00

ⓒ Optional Locking Cabinet w/Rack Mount

Part No.	Dimensions	Ship Wt.	Price
■ 34445*	25"H x 19 3/4"W x 25"D	21 lbs	\$163.80

ⓓ Electrical Assembly

Part No.	Description	Ship Wt.	Price
■ 66450*	4-outlet / 25'cord / winder	4 lbs	\$62.00
■ 66572*	7-outlet / 25'cord / winder	8 lbs	\$88.00



Please refer to p. 2 for a description of symbols.

Xtra Long Presentation Cart

- » The Xtra Long Presentation Cart comes standard with four shelves for AV equipment. Cart available in gray or cherry.
- » GREENGUARD Indoor Air Quality Certified® and GREENGUARD Children & Schools CertifiedSM.
- » Laptop shelf is height adjustable. Optional shelf mounts below the laptop shelf.
- » Black powder-coated steel frame includes 3" casters (two locking). Larger 5" casters available.
- » Optional locking three-shelf cabinet mounts easily onto the bottom shelf. Optional electrical assemblies available.
- » TAA compliant.

A Xtra Long Presentation Cart					
Gray	Cherry	Dimensions	Ship Wt.	Price(Gray)	Price(Cherry)
27521**	27577	40 3/4"H x 18 1/2"W x 30"D	53 lbs	\$366.00	\$384.30

B Optional Shelf				
Gray	Cherry	Dimensions	Ship Wt.	Price
34465*	N/A	18"W x 18"D	10 lbs	\$91.00

C Optional Locking Cabinet				
Gray	Cherry	Dimensions	Ship Wt.	Price
34466*	66610*	20"H x 14"W x 15"D	47 lbs	\$186.00

D Electrical Assemblies				
Part No.	Description	Ship Wt.	Price	
66450*	4-outlet / 25'cord / winder	4 lbs	\$62.00	
66572*	7-outlet / 25'cord / winder	8 lbs	\$88.00	

E Optional Larger Casters			
Part No.	Dimensions	Ship Wt.	Price
66577	5" diameter	5 lbs	\$64.00



Please refer to p. 2 for a description of symbols.

All-Steel Presentation Cart

- » The All-Steel Presentation Cart holds your AV equipment in one compact, durable unit.
- » GREENGUARD Indoor Air Quality Certified® and GREENGUARD Children & Schools CertifiedSM.
- » Made from 16 and 18 gauge steel for superior strength and durability.
- » Top measures 18 1/8"W x 16"D. Laptop shelf is height adjustable in 2" increments. Optional shelf available for additional storage.
- » Includes 3" casters (two locking). Optional electrical assemblies are available.
- » TAA compliant.

A All-Steel Presentation Cart			
Part No.	Dimensions	Ship Wt.	Price
27547*	40 1/2" x 21 1/2"W x 30"D	48 lbs	\$465.97

B Optional Shelf			
Part No.	Description	Ship Wt.	Price
27548*	18"W x 14"D	5 lbs	\$59.00

D Electrical Assemblies			
Part No.	Description	Ship Wt.	Price
66450*	4-outlet / 25'cord / winder	4 lbs	\$62.00
66572*	7-outlet / 25'cord / winder	8 lbs	\$88.00





Includes extendable shelf to accommodate various sizes of document cameras.

Two elastic buckling straps included to secure projectors, document cameras, or other devices.

Includes clips for cord management.

Center post works as a hub for a variety of accessories. Each accessory is independently height-adjustable.

NEW!



Shelves mount and cantilever using the vertical grooves of the pole. Shelves are height adjustable to allow for multiple configurations.



Please refer to p. 2 for a description of symbols.

Reflex® Guest Chair, p. 152.

Alpha Cart

- » The Alpha Cart is a versatile, mobile, modular and height-adjustable cart ideal for document cameras, projectors, laptops, and monitors.
- » Frame includes 3" locking casters on a stable star base, and three independently adjustable shelves.
- » Center post works as a hub, allowing for three included shelves. Cable management clips keep cords under control.
- » Projector shelf measures 15" x 11".
- » Laptop/keyboard shelf is angled 7°, measures 15 3/4" x 11 3/4", and includes a mouse platform (6" x 6 5/8") that swivels beneath when not in use.
- » Document camera shelf measures 15" x 13 5/8" and features a retractable platform (13 1/2" x 8 5/8"). All shelves feature non-slip EVA pads.



Laptop shelf features a retractable mouse pad.

Alpha Cart

Part No.	Dimensions	Ship Wt.	Price
■ 27588*	47"H x 31 3/4"W x 27 1/2"D	43 lbs	\$525.85



Four-outlet electrical assembly included.



Locking front side doors

31"
to
39"

Reverse side



Please refer to p. 2 for a description of symbols.

FDB AV Cart

- » The FDB AV Cart is large enough for equipment yet small enough to easily handle. GREENGUARD Indoor Air Quality Certified® and GREENGUARD Children & Schools CertifiedSM.
- » Wide top features ample room for a projector and a document camera
- » Cart is height adjustable from 31" - 39" in 1" increments.
- » Lower cabinet features grommet holes and is perforated to cool equipment when in use. Interior measures 15"H x 32"W x 24"D with a 14"H x 30"W door opening.
- » Includes four outlet electrical assembly.
- » Seven outlet electrical assembly available to mount inside the cabinet.
- » TAA compliant. 10 year guarantee.

© FDB AV Cart			
Part No.	Dimensions	Ship Wt.	Price
■ 27565	31" - 39"H x 32 1/4"W x 24 1/2"D	69 lbs	\$744.19
Optional Electrical Assembly			
Part No.	Description	Ship Wt.	Price
■ 66572*	7-outlet / 25' cord / winder	4 lbs	\$88.00



Scan this QR code to watch this product's online video.



Folding side wing shelves on both sides for laptops and document cameras.



Locking rear side door closed.



Locking projector side doors closed.



Flat panel mount also available.



Optional Monitor Mount Arm.



Multimedia panel



Four-outlet electrical assembly included.

See product video online!
youtube.com/moorecoinc



Please refer to p. 2 for a description of symbols.

The Boss

- » The Boss AV cart features a gray powder-coat finish and assembles in less than 15 minutes.
- » GREENGUARD Indoor Air Quality Certified® and GREENGUARD Children & Schools CertifiedSM.
- » Includes an electrical assembly and a multimedia panel under either foldable side shelf.
- » Locking front and rear doors. Front doors include storage bins mounted to the inside. Includes a retractable and angle adjustable projector shelf.
- » Rear features a built in second electrical assembly.
- » Optional flat panel mount, monitor mount, and rack mount available.
- » TAA compliant. 10 year guarantee.



❶ The Boss AV Cart

Part No.	Dimensions	Ship Wt.	Price
■ 27513	36 1/2"H x 23 1/2"W x 20 1/2"D	135 lbs	\$1,784.12

❷ Flat Panel Mount Bracket

Part No.	Dimensions	Ship Wt.	Price
■ 66575*	26"H x 31"W x 12"D	24 lbs	\$490.00

❸ Monitor Mount Arm

Part No.	Dimensions	Ship Wt.	Price
■ 66576*	18"H x 20 1/2"D	9 lbs	\$233.00

❹ Rack Mount

Part No.	Description	Ship Wt.	Price
■ 66578*	19" rack mount equipment	3 lbs	\$77.00

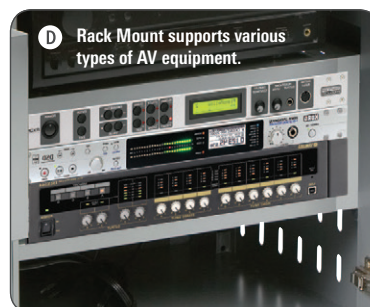

❺ Rack Mount supports various types of AV equipment.



Please refer to p. 2 for a description of symbols.

Rolz-2

- » The Rolz-2 AV cart provides storage and easy maneuverability.
- » GREENGUARD Indoor Air Quality Certified® and GREENGUARD Children & Schools CertifiedSM.
- » Locking double doors conceal a generous storage area with a retractable shelf.
- » Middle shelf adjusts in three positions, and storage drawer measures 8"H x 17 1/4"W x 11"D. Optional side shelf (20"W x 16"D) attaches to either side of the unit.
- » Handle and two 5" casters provide mobility. Optional electrical assembly mounts inside the unit.

Handle provides easy mobility.



Heavy duty 5" casters.



Interior includes storage drawer and adjustable shelf.



Optional side shelf mounts on either side.



A Rolz-2			
Part No.	Dimensions	Ship Wt.	Price
89765**	41 1/2"H x 23 1/2"W x 17"D	93 lbs	\$517.88
B Optional Shelf			
Part No.	Dimensions	Ship Wt.	Price
34404*	20"W x 16"D	9 lbs	\$75.00
C Optional Electrical Assembly			
Part No.	Description	Ship Wt.	Price
66573*	7-outlet / 25' cord / mounting brackets	4 lbs	\$80.00



Folding side shelf for document camera or other equipment.

Three stationary interior shelves.

Retractable laptop/keyboard shelf.

Built in rack mount.



Locking top compartment.



Locking bottom compartment.



Please refer to p. 2 for a description of symbols.

Command Center

- » The exceptionally versatile Command Center keeps you in command of your presentations.
- » Top (22"W x 20"D) features a 7" deep compartment with a locking lift-lid for security.
- » Foldable side shelf holds a document camera or other equipment.
- » Retractable shelf (20"W x 12 1/2"D) can be used with a keyboard or a laptop.
- » Top interior shelf (20"W x 17"D) has 3 1/4" of clearance.
- » Two other stationary shelves have 4 1/2" of clearance.
- » Rack panel mounts hold standard 19" equipment and provide 14 1/2" of rack space.
- » Locking door folds flush against the unit. A magnet holds the door open when in use.
- » Handle and heavy duty 4" swivel casters (two locking) allow easy mobility.
- » An optional UL/CSA-approved electrical assembly can be mounted inside the top lift-lid.
- » May be TAA compliant.

C Command Center			
Part No.	Dimensions	Ship Wt.	Price
89853*	45"H x 25"W x 25"D	130 lbs	\$785.00
D Electrical Assembly			
Part No.	Description	Ship Wt.	Price
66450*	4-outlet / 25' cord / winder	4 lbs	\$62.00



38 1/2" to 44 1/2"

3" casters (two locking).

Shown as a fully loaded workstation.



Please refer to p. 2 for a description of symbols.

Web AV

- » The Web AV cart is height-adjustable (38 1/2" - 44 1/2").
- » Use as a projector stand or as a stand up workstation.
- » Top shelf measures 24"W x 18"D. Laptop/keyboard shelf measures 24"W x 14"D.
- » CD rack and CPU holder included.
- » Black powder-coated steel frame includes 3" casters (2 locking).
- » May be available as TAA. Please call for details.

A Web AV			
Part No.	Dimensions	Ship Wt.	Price
85052*	38 1/2" - 44 1/2"H x 24"W x 31"D	44 lbs	\$258.35

B Electrical Assembly			
Part No.	Description	Ship Wt.	Price
66450*	4-outlet / 25' cord / winder	4 lbs	\$62.00



Four-outlet electrical assembly available.



Please refer to p. 2 for a description of symbols.

PBL AV Cart

- » The PBL provides versatility and easy mobility for AV equipment.
- » Top shelf can be adjusted from 41 1/2" to 47 1/2" in height.
- » Middle shelf can be extended outward to provide easy access.
- » Unit is reinforced with a wrap lock panel attached to the bottom, ensuring stability and rigidity.
- » Black powder-coated steel frame includes 3" casters (two locking)
- » Optional UL/CSA-approved electrical assembly available.
- » TAA compliant.



41 1/2" to 47 1/2"

3" casters (two locking).



Please refer to p. 2 for a description of symbols.

Proview AV Cart

- » The Proview AV cart features two pneumatically adjustable platforms for superior versatility.
- » GREENGUARD Indoor Air Quality Certified® and GREENGUARD Children & Schools CertifiedSM.
- » Larger platform (24"W x 18"D) is height adjustable from 28 1/2" to 38 1/2". Smaller platform (18"W x 18"D) is height adjustable from 34 1/2" to 44 1/2".
- » Locking box (13 1/2"H x 16"W x 12 1/2"D) provides secure storage.
- » Black powder-coated steel frame with laminate shelves. Includes 3" casters (two locking).
- » Optional UL/CSA-approved electrical assembly is available.
- » TAA compliant.



Pneumatic height adjustment

28 1/2" to 38 1/2"

3" casters (two locking).

C Proview AV Cart			
Part No.	Dimensions	Ship Wt.	Price
81052*	41 1/2" - 47 1/2"H x 18"W x 20"D	34 lbs	\$261.89

B Electrical Assembly			
Part No.	Description	Ship Wt.	Price
66450*	4-outlet / 25' cord / winder	4 lbs	\$62.00

D Proview AV Cart			
Part No.	Dimensions	Ship Wt.	Price
82692**	34 1/2"-44 1/2"H x 32"W x 24"D	93 lbs	\$700.73

B Electrical Assembly			
Part No.	Description	Ship Wt.	Price
66450*	4-outlet / 25' cord / winder	4 lbs	\$62.00





Please refer to p. 2 for a description of symbols.

Champ

- » The Champ is an economical yet fully featured AV and presentation cart.
- » GREENGUARD Indoor Air Quality Certified® and GREENGUARD Children & Schools CertifiedSM.
- » Three locking doors keep equipment secure while providing easy accessibility.
- » Locking slide-out top holds projector and covers a 2" deep storage compartment.
- » Two adjustable shelves include grommets for easy cable management.
- » Includes 3" casters (two locking).
- » TAA compliant.

Champ	Part No.	Dimensions	Ship Wt.	Price
	89852***	39 1/2"H x 28"W x 21"D	121 lbs	\$459.60



Folding side shelf provides extra equipment space.



Three locking doors keep equipment secure. Each shelf has a grommet.



Please refer to p. 2 for a description of symbols.



Diversity Stand

- » The versatile Diversity Stand can be used as an AV center, a workstation, or as a lectern.
- » GREENGUARD Indoor Air Quality Certified® and GREENGUARD Children & Schools CertifiedSM.
- » Adjusts in height from 37 1/2" to 45 1/2".
- » Top shelf measures 23 3/4"W x 12"D. Slanted shelf measures 23 3/4"W x 11 3/4"D and is angled down 40°.
- » Middle shelf measures 18 3/4"W x 15 3/4"D. Storage box measures 14 1/2"H x 18 3/4"W x 9 1/2"D.
- » Black powder-coated steel frame Includes 3" casters (two locking).

Diversity Stand	Part No.	Dimensions	Ship Wt.	Price
	89786*	37 1/2" - 45 1/2"H x 23 3/4"W x 26"D	47 lbs	\$269.00



Use as a lectern, a projector stand, or a stand up workstation.



37 1/2" to 45 1/2"

Spacious storage box.

3" casters for easy mobility.



Please refer to p. 2 for a description of symbols.

Pneu-Lect

- » The Pneu-Lect is a versatile lectern that also doubles as a projector stand.
- » GREENGUARD Indoor Air Quality Certified® and GREENGUARD Children & Schools CertifiedSM.
- » Adjusts pneumatically in height from 39 1/2" to 49 1/2". Oak laminate platform adjusts to three angles to hold presentation materials or AV equipment.
- » Black powder-coated steel frame with 3" casters (two locking).
- » TAA compliant.

Pneu-Lect	Part No.	Dimensions	Ship Wt.	Price
	85272*	39 1/2" - 49 1/2"H x 24 1/2"W x 24"D	49 lbs	\$289.80

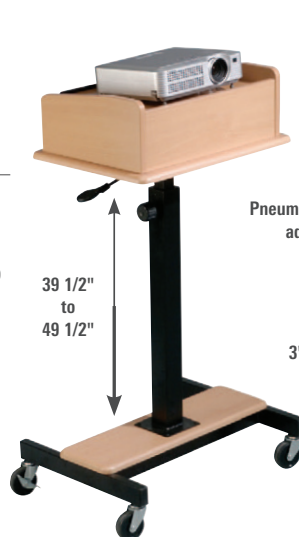

Pneumatically height adjustable.

39 1/2" to 49 1/2"

3" casters





25' cord and winder included.



Top shelf includes a non-skid mat.

Shelves completely retract when not in use.

Two height adjustable and retractable shelves.

26" to 42"

Spacious locking storage cabinet.

All steel construction.

4" casters.



Please refer to p. 2 for a description of symbols.

Dual Adjustable Laptop Utility Cart

- » The Dual Adjustable Laptop Utility Cart is durable and versatile.
- » Black powder-coated steel frame includes 4" casters (2 locking). Adjusts in height from 26" to 42". Includes a 26"H locking storage cabinet.
- » Includes two adjustable retractable shelves to hold a projector or other equipment.
- » Electrical assembly with four outlets, a 25' cord included.
- » 10 year guarantee. GREENGUARD Indoor Air Quality Certified® and GREENGUARD Children & Schools CertifiedSM.



Dual Adjustable Laptop Utility Cart			
Part No.	Dimensions	Ship Wt.	Price
89875*	42"H x 24"W x 18"D	79 lbs	\$614.00



Please refer to p. 2 for a description of symbols.

Adjustable Laptop Utility Cart

- » The Adjustable Laptop Utility Cart features a retractable shelf to hold a laptop.
- » GREENGUARD Indoor Air Quality Certified® and GREENGUARD Children & Schools CertifiedSM.
- » An optional second retractable shelf is also available to hold additional equipment.
- » Adjusts in height from 26" to 42". Frame is black powder-coated steel.
- » Includes an electrical assembly with four outlets and a 25' cord, and 4" casters (two locking).

Retractable laptop shelf.



Non skid mat included.



Optional shelf.



www.moorecoinc.com/green for detailed information.

All steel construction.

4" casters make mobility easy.

A Adjustable Laptop Utility Cart

Part No.	Dimensions	Ship Wt.	Price
89842*	26" - 42"H x 26"W x 15"D	59 lbs	\$431.00

B Optional Shelf

Part No.	Dimensions	Ship Wt.	Price
34410*	Optional Shelf	10 lbs	\$118.00



Please refer to p. 2 for a description of symbols.

All-Steel Utility Carts

- » Line of All-Steel Utility Carts are durable and versatile. GREENGUARD Indoor Air Quality Certified® and GREENGUARD Children & Schools CertifiedSM.
- » Choose from height-adjustable (26"-42") carts, or from fully welded 26" or 42" high carts.
- » Height-adjustable cart is available with or without a locking storage cabinet.
- » Black powder-coated steel frame with 4" casters (two locking).
- » Electrical assembly included.

Assembles in 15 minutes or less!



www.moorecoinc.com/green for detailed information.

C Adjustable Utility Cart



26" to 42"

All steel construction.

D Adjustable Utility Cart with Cabinet



Locking storage cabinet.



E Fully Welded Utility Cart

C Adjustable Utility Cart

Part No.	Dimensions	Ship Wt.	Price
85892*	26" - 42"H x 24"W x 18"D	50 lbs	\$328.00

D Adjustable Utility Cart with Cabinet

Part No.	Dimensions	Ship Wt.	Price
85992*	26" - 42"H x 24"W x 18"D	50 lbs	\$413.00

E Fully Welded Utility Cart (26")

Part No.	Dimensions	Ship Wt.	Price
89752*	26"H x 24"W x 18"D	37 lbs	\$307.00

F Fully Welded Utility Cart (42")

Part No.	Description	Ship Wt.	Price
89753*	26"H x 24"W x 18"D	50 lbs	\$402.00



Please refer to p. 2 for a description of symbols.



CRT TV Carts

- » CRT TV Carts are available in three models to provide easy mobility for a variety of CRT sizes.
- » GREENGUARD Indoor Air Quality Certified® and GREENGUARD Children & Schools CertifiedSM.
- » Durable black-powder coated steel frame includes heavy duty casters (2 locking).
- » Each cart includes a UL/CSA approved electrical assembly with four outlets and a 25' cord.
- » Optional safety strap to secure the TV to the cart is available.

● CRT TV Cart - 48"			
Part No.	Dimensions	Ship Wt.	Price
■ 84552*	48"H x 32"W x 27"D	58 lbs	\$447.00
● CRT TV Cart - 44"			
Part No.	Dimensions	Ship Wt.	Price
■ 86092*	44"H x 38"W x 31"D	63 lbs	\$560.00
● CRT TV Cart - 32"			
Part No.	Dimensions	Ship Wt.	Price
■ 89771*	32"H x 37"W x 25"D	65 lbs	\$431.00
● Safety Strap			
Part No.	Dimensions	Ship Wt.	Price
■ 66550*	10'L x 2"W	1 lb	\$46.00



● Ideal for a variety of uses, including AV, food service, and janitorial.



Please refer to p. 2 for a description of symbols.

All-Service 8-in-1 Cart

- » Get eight carts in one with our versatile All-Service Cart.
- » The cart is adjustable to four heights: 16", 24", 34", or 42".
- » Includes removable wall panels that can be used to enclose each shelf.
- » Use as an AV cart, or attach the wall panels and use as a food service, janitorial, or utility cart.
- » Constructed from injection-molded plastic, the cart includes 4" casters (two locking).
- » A UL/cUL-approved electrical assembly with four outlets and a 20' cord is included.

● All-Service 8-in-1 Cart			
Part No.	Dimensions	Ship Wt.	Price
■ 27529*	16"- 42"H x 24"W x 18"D	35 lbs	\$351.54



A

Platinum gray powder-coated MDF top will not delaminate.



Platinum/Gray only.

Base design provides stability and mobility.



B Also available in Black Cherry Lumina finish.



Scan this QR code to watch this product's online video.



Please refer to p. 2 for a description of symbols.

Lumina™ Podium

- » The Lumina™ Podium adds style and elegance to any speaking environment. Available in platinum or in black cherry.
- » Top measures 21 1/2"W x 17 3/4"D and is finished in either antimicrobial powder-coated MDF (platinum) or in a rich cherry woodgrain laminate (black cherry).
- » Front access box (2"-4"H x 18"W x 14"D) provides storage for presentation materials.
- » Base is powder-coated steel and includes 3" locking casters.
- » Platinum carries a limited lifetime warranty.

● Lumina™ Podium - Platinum	Part No.	Dimensions	Ship Wt.	Price
■	27562	44 3/4"H x 25"W x 24"D	36 lbs	\$379.00
● Lumina™ Podium - Black Cherry	Part No.	Description	Ship Wt.	Price
■	27574	44 3/4"H x 25"W x 24"D	36 lbs	\$379.00

See matching Lumina™ Series products on pages 12-15!





A Stand alone lectern.

Angle adjustable top.

Pop-out side shelf.



Locking storage cabinet features two adjustable shelves.

B Lectern with workstation.



B



Perforated modesty panel.



Please refer to p. 2 for a description of symbols.

Lecture Station

- » The innovative Lecture Station combines a workstation and lectern into one convenient unit.
- » GREENGUARD Indoor Air Quality Certified® and GREENGUARD Children & Schools CertifiedSM.
- » Desktop surface (36"W x 19 3/4"D) is teak HPL. Locking drawer is 2 1/2"H x 21 1/2"W x 15"D. Lectern top (22 1/4"W x 22 1/4"D) tilts 10° and locks into place. Pop-out shelf on the side.
- » Interior (32 1/2"H x 18 1/4"W x 19 1/4"D) features two adjustable shelves and a locking door.
- » Integrated wire management conduits in the desk top and lectern body. Frame is black powder-coated steel with 3" non-marring casters.
- » TAA compliant.

ⓐ Lecture Station - Stand Alone Lectern

Part No.	Description	Ship Wt.	Price
■ 27537L	43"H x 22 1/4"W x 22 1/4"D	93 lbs	\$667.88

ⓑ Lecture Station - Full Workstation

Part No.	Dimensions	Ship Wt.	Price
■ 27537	43"H x 58 1/2"W x 22 1/4"D	141 lbs	\$1,132.00

B Oak

Retractable side shelf.



Retractable keyboard shelf.



Recessed casters provide mobility without affecting aesthetics.

C

Mahogany



Please refer to p. 2 for a description of symbols.

Floor Lectern

- » An attractive lectern, the Floor Lectern perfectly combines style and economy.
- » GREENGUARD Indoor Air Quality Certified® and GREENGUARD Children & Schools CertifiedSM.
- » Recessed 3" casters (two locking) provide mobility without impairing aesthetics. Caster design also prevents tipping. Retractable keyboard/laptop shelf includes a security lip to keep equipment in place.
- » Includes a slanted top and a side shelf that can be slid inside the lectern when not in use. Two interior storage shelves provide ample space for storage.
- » Available with an oak or mahogany laminate finish.
- » TAA compliant.

ⓐ Floor Lectern - Oak

Part No.	Dimensions	Ship Wt.	Price
■ 27510**	46"H x 25"W x 20 1/4"D	97 lbs	\$377.00

ⓑ Floor Lectern - Mahogany

Part No.	Description	Ship Wt.	Price
■ 27508**	46"H x 25"W x 20 1/4"D	97 lbs	\$377.00



A Height Adjustable Sound Powered Lectern



TRUE
ADJUST.

Wireless microphone and LED reading light included.



Please refer to p. 2 for a description of symbols.

Sound Powered Lectern

- » The Sound Powered Lectern features an attractive natural cherry laminate finish.
- » GREENGUARD Indoor Air Quality Certified® and GREENGUARD Children & Schools CertifiedSM.
- » Includes a 50 watt amplifier to support an audience up to 2000. Wireless microphone and an LED light are included.
- » Recessed casters (2 locking) provide mobility without affecting aesthetics.
- » TAA compliant.

Height Adjustable Sound Powered Lectern

- » The Height Adjustable Sound Powered Lectern pneumatically adjusts in height 10".
- » Includes a 50 watt amplifier to support audiences up to 2000.
- » Wireless microphone and LED light are included.
- » Recessed casters (2 locking) provide mobility without affecting aesthetics.

A Height Adjustable Sound Powered Lectern			
Part No.	Dimensions	Ship Wt.	Price
■ 27534	45 ½"H x 22"W x 17"D	76 lbs	\$1,435.00
B Sound Powered Lectern			
Part No.	Description	Ship Wt.	Price
■ 27535*	45 ½" - 52 ½"H x 22"W x 17"D	66 lbs	\$1,127.00



Please refer to p. 2 for a description of symbols.

Metal Lectern

- » Ideal for industrial environments, the Metal Lectern provides long lasting strength.
- » GREENGUARD Indoor Air Quality Certified® and GREENGUARD Children & Schools CertifiedSM.
- » Constructed from 18-gauge steel panels with 16-gauge steel braces and finished with a brushed gray powder coat.
- » Box opening is perfect for storage, and measures 3 ¼"H x 22 ¾"W x 12"D. Base measures 3 ¼"H x 23"W x 14"D for superior stability. Leveling glides are included to keep the unit even.
- » Assembles in less than 15 minutes. TAA compliant.



C
Constructed from durable steel.



C Metal Lectern			
Part No.	Dimensions	Ship Wt.	Price
■ 89888*	47 ¾"H x 23"W x 14"D	40 lbs	\$323.00



A
T-15 Lift Lid
Lectern



B
T-30 Recessed
Top Lectern



C
T-35 Cross
Base Lectern



D
T-40 Full Pedestal
Lectern



Please refer to p. 2 for a description of symbols.

Oak Lecterns

- » Oak lecterns are constructed of solid oak and oak veneer.
- » Available in four styles and three finishes.
- » Ideal for conference rooms, meeting rooms, or classrooms.

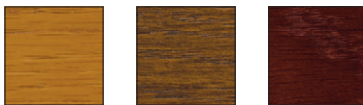

Light Oak Medium Oak Mahogany

Oak Lecterns			Item	Dimensions	Ship Wt.	Price
Lt Oak	Md Oak	Mahogany				
■ 75395**	■ 75490**	■ 75491**	Ⓐ T-15	45"H x 20 1/2"W x 18"D	40 lbs	\$395.00
■ 75589*	■ 75590**	■ 75591**	Ⓑ T-30	45"H x 20"W x 16"D	36 lbs	\$395.00
■ 75689*	■ 75690*	■ 75691*	Ⓒ T-35	45"H x 20"W x 16"D	25 lbs	\$267.00
■ 75789**	■ 75790**	■ 75791**	Ⓓ T-40	45"H x 20"W x 16"D	45 lbs	\$481.00



Please refer to p. 2 for a description of symbols.

Scamp

- » The Scamp Speaker Stand features a tilting platform (30° to -25°) with a padded wrist rest.
- » Height adjustable from 27" to 43". Ideal for a laptop or keyboard. Includes 2" casters.
- » May be TAA compliant.

A Scamp Speaker Stand				
Part No.	Dimensions	Ship Wt.	Price	
43062*	27" - 43"H x 22 1/2"W x 18"D	25 lbs	\$192.37	



www.moorecoinc.com/green for detailed information.



Please refer to p. 2 for a description of symbols.

T-Lect

- » The T-Lect is an economical lectern or presentation stand now available in five colors.
- » GREENGUARD Indoor Air Quality Certified® and GREENGUARD Children & Schools CertifiedSM.
- » Top (20"W x 16"D) adjusts from 30" to 42" in height. Base is black powder-coated steel.
- » TAA compliant.

B T-Lect				
Part No.	Color	Dimensions	Ship Wt.	Price (Walnut)
85751*	Oak	30" - 42"H x 20"W x 16"D	18 lbs	\$145.00
27582*	Cherry	30" - 42"H x 20"W x 16"D	18 lbs	\$145.00
27583*	Walnut	30" - 42"H x 20"W x 16"D	18 lbs	\$145.00
27585*	Mahogany	30" - 42"H x 20"W x 16"D	18 lbs	\$145.00
27584*	Gray	30" - 42"H x 20"W x 16"D	18 lbs	\$145.00





Please refer to p. 2 for a description of symbols.

Odyssey Charging Cart



- » Provide a safe place for your most valuable educational resources. The Odyssey Charging Cart provides security, efficiency, and mobility for up to 24 laptops, tablets, or other devices on seven adjustable shelves.
- » Ventilation holes prevent overheating, and durable locking mechanism ensures your equipment will be safe and ready to use when needed.
- » UL approved power strips included to charge up to 24 devices and aid in cable management.
- » Rear locking access panel makes access for charging easy.



Holds and charges up to 24 laptops or tablet devices with UL approved electrical assemblies.

A Odyssey Charging Cart

Part No.	Dimensions	Ship Wt.	Price
27652	40"H x 53"W x 24"D	250 lbs	Call



Please refer to p. 2 for a description of symbols.

Mobile Laptop Charging Stations

- » Keep up to 20 laptops secure and fully charged with a Mobile Laptop Charging Station.
- » GREENGUARD Indoor Air Quality Certified® and GREENGUARD Children & Schools Certified™.
- » Stations feature built-in UL/CSA-approved electrical outlets for each laptop compartment.
- » Locking doors fold back and stay open with a magnet while loading or unloading laptops. Laptop spaces measure 21 3/4"W x 14 3/4"D.
- » Cabinets includes 4" swivel casters (two locking) for easy maneuverability.
- » TAA compliant.



20 laptop unit

B

Locking doors prevent theft and tampering.

UL/CSA approved electrical outlet for each shelf.

C 10 laptop unit

Heavy duty casters provide easy mobility.

B 20 Laptop Charging Station

Part No.	Dimensions	Ship Wt.	Price
27541	50 7/8"H x 45"W x 19 1/4"D	232 lbs	\$1,070.00

C 10 Laptop Charging Station

Part No.	Description	Ship Wt.	Price
27540	50 7/8"H x 23 5/8"W x 19 1/4"D	139 lbs	\$736.00



www.moorecoinc.com/green for detailed information.

Training Tables



Elevation™ Mobile Stand shown with OneBoard™ Interactive Whiteboard.

See pp. 18 and 92.

NEW!

Shown in Nepal Teak.

Flip the tops and nest for compact storage.

Available in a variety of colors! Specify color code when ordering:

Amber Cherry
7919

Castle Oak
7928

Gray Nebula
4622

Nepal Teak
7209

Fusion Maple
7909

Graphite Nebula
4623



Nesting position allows for efficient table storage!
Shown in Graphite Nebula.



Find out more about our custom options in the Custom Furniture Guide on p. 10 or go to moorecoinc.com/custom



D.O.C. Partition, pp. 66-67.

Circulation Task Chairs, p. 156.

Use half rounds to create conference tables.



Teachers' lounge shown in Fusion Maple.

See more in our Admin Section, see p. 192.



Please refer to p. 2 for a description of symbols.

Height Adjustable Flipper Tables

- » Easily accommodate a range of ages and sizes with the Height Adjustable Flipper Table, the most flexible table on the market.
- » The Height Adjustable Flipper Tables adjust from 24 ¼" to 32 ¾" height and flip back with a simple one handed lever mechanism to allow for easy nesting and storage.
- » Each features a 1" thick HPL top available in six Quick Ship colors (please specify when ordering), or can be customized with any Wilsonart® HPL and edge band.
- » The black powder-coated steel frame includes a stabilizing stretcher bar and 3" locking casters.
- » TAA compliant. Tested to support up to 300 lbs.



Easy-to-pull handle engages the flipping mechanism.



Every table has round grommets for cable management.

Fusion Maple surface

Height comparison shown in Gray Nebula.



Half Round shown in Castle Oak.



72" Table shown in Amber Cherry.

A Height Adjustable Flipper Table - 6024

Part No.	Dimensions	Ship Wt.	Price
90179-XXXX-XX	24 ¼" - 32 ¾"H x 60"W x 24"D	90 lbs	\$438.00

B Height Adjustable Flipper Table - 7224

Part No.	Dimensions	Ship Wt.	Price
90180-XXXX-XX	24 ¼" - 32 ¾"H x 72"W x 24"D	123 lbs	\$490.00

C Height Adjustable Flipper Table - Half Round

Part No.	Dimensions	Ship Wt.	Price
90178-XXXX-XX	24 ¼" - 32 ¾"H x 48"W x 24"D	61 lbs	\$379.00

Training Tables



Teak



Mahogany



Please refer to p. 2 for a description of symbols.

Tables flip and nest for easy storage!



Flipper Training Tables

- » Easily create a multipurpose work area with versatile Flipper Conference and Training Tables.
- » GREENGUARD Indoor Air Quality Certified® and GREENGUARD Children & Schools CertifiedSM.
- » Tops are vacuum-formed PVC available with a teak or mahogany wood grain finish.
- » Flip top back with a simple lever mechanism and nest together space-saving storage.
- » Frame is black powder-coated steel and includes a perforated steel modesty panel.
- » Each table rolls easily out of the way on 2" casters (two locking).
- » TAA compliant. 10 year guarantee. Tested to support up to 300 lbs.

A Flipper Table - 36x24				
Part No.	Color	Dimensions	Ship Wt.	Price
89870*	Teak	29 1/2"H x 36"W x 24"D	56 lbs	\$369.63
89876*	Mahogany	29 1/2"H x 36"W x 24"D	56 lbs	\$369.63
B Flipper Table - 60x24				
Part No.	Color	Dimensions	Ship Wt.	Price
89775	Teak	29 1/2"H x 60"W x 24"D	86 lbs	\$597.70
89879	Mahogany	29 1/2"H x 60"W x 24"D	86 lbs	\$597.70
C Flipper Table - 72x24				
Part No.	Color	Dimensions	Ship Wt.	Price
89863	Teak	29 1/2"H x 72"W x 24"D	118 lbs	\$633.65
89880	Mahogany	29 1/2"H x 72"W x 24"D	118 lbs	\$633.65
D Flipper Table - Half Round				
Part No.	Color	Dimensions	Ship Wt.	Price
89773**	Teak	29 1/2"H x 48"W x 24"D	58 lbs	\$448.28
89877**	Mahogany	29 1/2"H x 48"W x 24"D	58 lbs	\$448.28



Green-Rite® eco-friendly markerboard available on pp. 24, 182.



Platinum Reversible Board available on pp. 62-63.



Presentation Cart available on p. 104.

Circulation chairs available on p. 156.



Flipper tables are ideal for training rooms or conference rooms.

Training Tables



Flipper tables are ideal for training rooms or conference rooms.

Elevation™ Mobile Stand shown with OneBoard™ Interactive Whiteboard.

See pp. 18 and 92.

Chi Flipper Tables shown in Gray Nebula.



Cherry



Gray Nebula

Specify color code when ordering.



Chi Flipper Tables shown in Cherry finish.



Nesting position allows for efficient table storage!

Shown in Cherry finish.



Please refer to p. 2 for a description of symbols.

Chi Flipper Tables

- » Elegant Chi Flipper Tables make an ideal addition to any training room.
- » GREENGUARD Indoor Air Quality Certified® and GREENGUARD Children & Schools CertifiedSM.
- » Tops are vacuum-formed PVC with either a gray nebula or cherry woodgrain finish.
- » Tops flip back with a simple lever mechanism. Frame is black powder-coated steel with a full length stretcher bar and a privacy panel. Roll easily out of the way on 2" casters (two locking).
- » TAA compliant. Tested to support up to 300 lbs.

www.moorecoinc.com/green
for detailed information.



A 60" Table shown in Cherry.



C

Half Round shown in Cherry.



A



60" Table shown in Gray Nebula.

D.O.C. Partition, p. 66-67.



Renew Guest Chair, p. 156.

Use half rounds to create conference tables.



Teachers' lounge shown in Cherry finish.

See more in our Admin Section, see p. 194.

A Chi Flipper Table - 6024				
Cherry	Gray Nebula	Dimensions	Ship Wt.	Price
■ 90099	■ 90102	29 1/2"H x 60"W x 24"D	86 lbs	\$344.89

B Chi Flipper Table - 7224				
Cherry	Gray Nebula	Dimensions	Ship Wt.	Price
■ 90100	■ 90103	29 1/2"H x 72"W x 24"D	118 lbs	\$394.57

C Chi Flipper Table - Half Round				
Cherry	Gray Nebula	Dimensions	Ship Wt.	Price
■ 90098	■ 90101	29 1/2"H x 48"W x 24"D	58 lbs	\$277.05

Training Tables



Please refer to p. 2 for a description of symbols.

Economy Flipper Tables

- » Use versatile and economical Economy Flipper Tables for your training or conference room.
- » GREENGUARD Indoor Air Quality Certified® and GREENGUARD Children & Schools CertifiedSM.
- » Tops are vacuum-formed PVC with either a teak or mahogany wood grain finish.
- » Tops flip back with a simple lever mechanism and nest together for space-saving storage.
- » Frame is black powder-coated steel. Each table rolls easily out of the way on 2" casters (two locking).
- » TAA compliant.

www.moorecoinc.com/green
for detailed information.



72" Table shown in Mahogany.



72" Table shown in Teak.

Half Round shown in Teak.



Mahogany



Teak

Specify color when ordering.

Circulation Task Chair, p.156.

Use half rounds to create conference tables.



Teachers' lounge shown in Teak finish.

See more in our Admin Section, see p. 194.

Economy Flipper Tables

Stock	Item	Dimensions	Ship Wt.	Price
90092	1/2 Round Teak	29 1/2"H x 48"W x 24"D	58 lbs	\$234.62
90093	6024 Teak	29 1/2"H x 60"W x 24"D	86 lbs	\$300.02
90094	7224 Teak	29 1/2"H x 72"W x 24"D	118 lbs	\$328.56
90095	1/2 Round Mahogany	29 1/2"H x 48"W x 24"D	58 lbs	\$234.62
90096	6024 Mahogany	29 1/2"H x 60"W x 24"D	86 lbs	\$300.02
90097	7224 Mahogany	29 1/2"H x 72"W x 24"D	118 lbs	\$328.56

Flipper tables are ideal for training rooms or conference rooms.

Economy Flipper Tables shown in Mahogany.



Black Lumina™ Reversible Board, see p. 65 .

Nesting position allows for efficient table storage!

Shown in Teak finish.



Classroom shown in Teak finish.

Training Tables



Please refer to p. 2 for a description of symbols.

Lumina™ Folding Training and Conference Tables

- » Create a designer training or conference room with the elegant line of Lumina™ Tables. In stock in antimicrobial gray/platinum and in black cherry.
- » The antimicrobial technology is an integral part of the powder coat formula on the gray table tops, and inhibits the growth of mold, mildew, and fungus.
- » The 1" thick tops flip back with an easy-operation lever mechanism and roll easily out of the way on 3" casters (2 locking).
- » Powder-coated steel frame includes a stabilizing stretcher bar. Optional modesty panel available. Tested to support up to 300 lbs.
- » Limited lifetime warranty on antimicrobial gray only. GREENGUARD Indoor Air Quality Certified® and GREENGUARD Children & Schools CertifiedSM.
- » Custom top options available Call for details or visit www.moorecoinc.com/custom

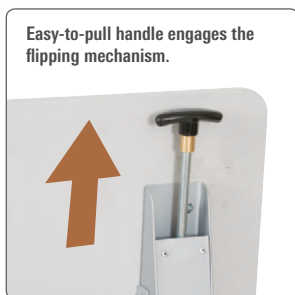

Platinum Lumina™ powder-coated MDF tops are antimicrobial.



Basic 60" Tables shown without Modesty Panels.



Black Cherry Lumina™ woodgrain vacuum-formed PVC with black frame



NEW! Matching Modesty Panels now available!

Nesting position allows for space-saving storage!



Use half rounds to create conference tables.

See more in our Admin Section, see p. 195.

Platinum Lumina™ Half Round

A Lumina™ Folding Tables - 6024						
Platinum	Black Cherry	Dimensions	Ship Wt.	Price (Platinum)	Price (Black Cherry)	
89954	90064	29 1/2"H x 60"W x 24"D	81 lbs	\$576.45	\$502.95	
B Lumina™ Folding Tables - 7224						
Platinum	Black Cherry	Dimensions	Ship Wt.	Price (Platinum)	Price (Black Cherry)	
89955	90067	29 1/2"H x 72"W x 24"D	113 lbs	\$628.95	\$565.95	
C Lumina™ Folding Tables - Half Round						
Platinum	Black Cherry	Dimensions	Ship Wt.	Price (Platinum)	Price (Black Cherry)	
89956**	89999**	29 1/2"H x 48"W x 24"D	53 lbs	\$423.15	\$397.95	
D Lumina™ Modesty Panel						
Platinum	Black Cherry	Dimensions	Ship Wt.	Price (Platinum)	Price (Black Cherry)	
66613*	66612*	10"H x 45"W x 3"D	11 lbs	\$99.99	\$99.99	



Custom colors available!
see pp. 10-11.



Circulation Task Chair, p. 156.



Scan this QR code to watch this product's online video.

Limited Lifetime Warranty!

Platinum/Gray only. Platinum Lumina™ Tables shown with Modesty Panels.



Antimicrobial Platinum Lumina™ top with gray frame.



Platinum Lumina™ powder-coated MDF tops are antimicrobial.



Find out more online!
[youtube.com/moorecoinc](https://www.youtube.com/moorecoinc)

Children & Schools
GREENGUARD®
Indoor Air Quality Certified
www.moorecoinc.com/green
for detailed information.

Training Tables



Nesting position allows for space-saving storage!



Cherry



Please refer to p. 2 for a description of symbols.

www.moorecoinc.com/green
for detailed information.



Chi Flipper Seminar Tables

- » The Chi Flipper Seminar Table is ideal for seminar set ups, training environments, and is ideal for use with today's smaller notebook and tablet computers.
- » One space-saving table easily sits up to three people.
- » Vacuum-formed PVC top in cherry woodgrain with a black powder-coated steel frame. Tested to support up to 300 lbs. Tables coordinate with other Chi table offerings.
- » Tops flip back for easy set up, break down, and storage.

Chi Flipper Seminar Table - 7220

Part No.	Dimensions	Ship Wt.	Price
90132	29 1/2"H x 72"W x 20"D	69 lbs	\$365.05



Children & Schools
GREENGUARD[®]
 Indoor Air Quality Certified
www.moorecoinc.com/green
 for detailed information.



Cherry



Teak



Please refer to p. 2 for a description of symbols.

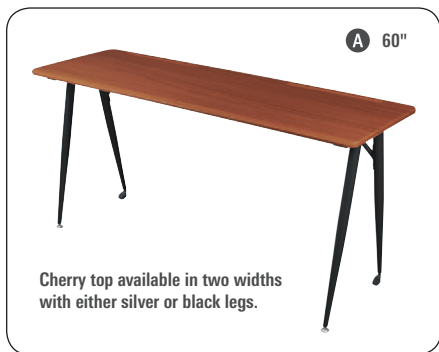

Cherry top available in two widths with either silver or black legs.



Also available with a teak top and silver legs.

iFlex™ Seminar Tables

- » With logical design and modern good looks, iFlex™ Seminar Tables are space-saving and economical.
- » GREENGUARD Indoor Air Quality Certified® and GREENGUARD Children & Schools CertifiedSM.
- » Durable surface finished in cherry woodgrain vacuum-formed PVC, coordinating with other iFlex™ pieces. Pencil grooves built in. Available with silver or black legs. Teak woodgrain top with silver legs available in the 7220 model.
- » Assembly is easy, and tables are a snap to move and arrange with stable glides on front legs and swivel casters on back legs.
- » TAA compliant. Tested to support up to 300 lbs.

A iFlex™ Seminar Table - 6020			Dimensions	Ship Wt.	Price
Cherry/Black	Cherry/Silver	Teak/Silver			
■ 90114	■ 90104	N/A	29"H x 60"W x 20"D	62 lbs	\$390.41

B iFlex™ Seminar Table - 7220			Dimensions	Ship Wt.	Price
Cherry/Black	Cherry/Silver	Teak/Silver			
■ 90115	■ 90105	■ 90113	29"H x 72"W x 20"D	69 lbs	\$412.81

Training Tables



D.O.C. Partition, pp. 66-67.

NEW!

Elevation™ Mobile Stand shown with OneBoard™ Interactive Whiteboard.

See pp. 18 and 92.

Circulation Task Chairs, p. 156.

72" tables also available.



Oak



Please refer to p. 2 for a description of symbols.

Mentor Seminar Tables

- » With classic design and modern good looks, Mentor Seminar Tables are space-saving and economical.
- » Available in two sizes. Durable surface finished in oak woodgrain vacuum-formed PVC. Built-in pencil grooves.
- » Assembly is easy, and tables are a snap to move and arrange with stable glides on front legs and swivel casters on back legs.
- » TAA compliant. Tested to support up to 300 lbs.

Ⓐ Mentor Seminar Table - 6020			
Part No.	Dimensions	Ship Wt.	Price
■ 90122	29"H x 60"W x 20"D	62 lbs	\$310.64
Ⓑ Mentor Seminar Table - 7220			
Part No.	Dimensions	Ship Wt.	Price
■ 90123	29"H x 72"W x 20"D	69 lbs	\$328.47



Please refer to p. 2 for a description of symbols.

Set up in less than 5 minutes!



Children & Schools
GREENGUARD®
Indoor Air Quality Certified
www.moorecoinc.com/green
for detailed information.

Agility Tables

- » Multifunctional Agility Tables can be set up in less than five minutes. Simply lift the top, unfold the legs and secure top to base with built-in connectors.
- » GREENGUARD Indoor Air Quality Certified® and GREENGUARD Children & Schools CertifiedSM.
- » Tables join with rounded corner connectors, allowing multiple configurations. Ideal for training rooms, conference rooms, or for use as an office suite.
- » Steel base includes built in storage shelf and casters.
- » TAA compliant.



Part No.	Dimensions	Ship Wt.	Price
A Agility Table - 6024			
89959	29 1/2"H x 60"W x 24"D	52 lbs	\$579.00
B Agility Table - 7224			
89960	29 1/2"H x 72"W x 24"D	64 lbs	\$639.00
C Agility Table - 6030			
89961	29 1/2"H x 60"W x 30"D	64 lbs	\$698.00
D Agility Table - 7230			
89962	29 1/2"H x 72"W x 30"D	72 lbs	\$775.00
E Corner Connector - 24"			
89964	1 1/2"H x 24"W x 24"D	12 lbs	\$179.00
F Corner Connector - 30"			
89966	1 1/2"H x 30"W x 30"D	15 lbs	\$209.00



Please refer to p. 2 for a description of symbols.

www.moorecoinc.com/green
for detailed information.



PJ Table

- » The PJ Table is perfect for use in training rooms, or as a supplemental table for any work area.
- » GREENGUARD Indoor Air Quality Certified® and GREENGUARD Children & Schools CertifiedSM.
- » Black powder-coated steel frame includes a modesty panel. Black 3/4" thick laminate top.
- » Adjustable floor glides and 2" casters (two locking) are included.
- » TAA compliant.

Part No.	Dimensions	Ship Wt.	Price
PJ Table			
89824*	29 1/2"H x 55"W x 19 3/4"D	58 lbs	\$289.00



Training Tables



Please refer to p. 2 for a description of symbols.



www.moorecoinc.com/green
for detailed information.



E. Eazy Workstation

- » The E. Eazy Workstation features easy pneumatic height adjustment from 20" to 30".
- » GREENGUARD Indoor Air Quality Certified® and GREENGUARD Children & Schools CertifiedSM.
- » Stability knobs lock the tabletop in place once the desired height is set.
- » Brushed steel frame and gray laminate top allows one or two users. Included CPU holders mount either inside or outside the frame.
- » TAA compliant.

A E. Eazy Workstation				
Stock	Dimensions	Ship Wt.	Price	
82091*	20" - 30"H x 60"W x 30"D	105 lbs	\$586.00	



Please refer to p. 2 for a description of symbols.

LX 72 Workstation

- » With its clean lines, the LX 72 workstation is ideal for any training room environment.
- » GREENGUARD Indoor Air Quality Certified® and GREENGUARD Children & Schools CertifiedSM.
- » Featuring a 3/4" thick teak or gray top, the workstation includes a black powder-coated steel frame. CPU bays (23 1/2"H x 9"W x 21"D) include locking doors.
- » Two retractable keyboard shelves (22"W x 10 1/2"D) include a built-in pen and pencil holder. Wire management conduits are located through the top and side leg(s) of the units.
- » TAA compliant. 10 year guarantee.



B LX 72				
Stock	Color	Dimensions	Ship Wt.	Price
89844	Teak	29"H x 72"W x 24"D	108 lbs	\$578.55
90107	Gray	29"H x 48"W x 24"D	108 lbs	\$578.55

See p. 206 for LX 48 Workstation for single user.



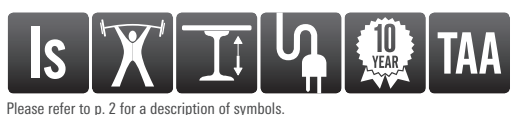

Please refer to p. 2 for a description of symbols.

Brawny Tables

- » Brawny tables are ideal for use as workstations, training tables, or as a supplemental table.
- » GREENGUARD Indoor Air Quality Certified® and GREENGUARD Children & Schools CertifiedSM.
- » Top is 1 1/4" thick scratch-resistant HPL. Table comes in three sizes. Custom tops available! Call for details or visit www.moorecoinc.com/custom.
- » Each table includes a built in cable management tray, leveling glides, and casters.
- » Optional CPU holders are available separately for use as a workstation.
- » TAA compliant. 10 year guarantee.

Need more custom colors? See pages 10-11 for more Brawny customization options!

A Brawny Tables - Gray					
Stock	Item	Dimensions	Ship Wt.	Price	
■ 89847**	Brawny 36	25 1/2" - 33 1/2"H x 36"W x 30"D	59 lbs	\$412.14	
■ 89848	Brawny 60	25 1/2" - 33 1/2"H x 60"W x 30"D	81 lbs	\$534.50	
■ 89862	Brawny 72	25 1/2" - 33 1/2"H x 72"W x 30"D	122 lbs	\$601.85	
■ 89849*	CPU Holder	10 1/4"W x 16 1/2"D	8 lbs	\$52.00	

B Brawny Tables - Custom Colors						
Gray Nebula	Md Oak	Mahogany	Item	Dimensions	Ship Wt.	Price
■ 89940**	■ 89946**	■ 89943**	Brawny 36	25 1/2" - 33 1/2"H x 36"W x 30"D	59 lbs	\$437.11
■ 89941	■ 89947	■ 89944	Brawny 60	25 1/2" - 33 1/2"H x 60"W x 30"D	81 lbs	\$583.39
■ 89942	■ 89948	■ 89945	Brawny 72	25 1/2" - 33 1/2"H x 72"W x 30"D	122 lbs	\$659.04
■ 89849-B*	■ 89849-B*	■ 89849-B*	CPU Holder	10 1/4"W x 16 1/2"D	8 lbs	\$52.00

Training Tables



Please refer to p. 2 for a description of symbols.

Split Level 72

- » Split Level Tables feature two platforms, each height adjustable from 25 1/2" to 31 1/2".
- » GREENGUARD Indoor Air Quality Certified® and GREENGUARD Children & Schools CertifiedSM
- » The 72" width can accommodate dual users.
- » CPU holder and a desktop grommet included.
- » Black powder-coated steel frame with gray laminate tops.
- » May be available as TAA compliant. Please call for details. 10 year guarantee.



A Split Level Tables		Dimensions	Ship Wt.	Price
Stock	Item			
83080	Split Level 72	25 1/2" - 31 1/2"H x 72"W x 36"D	96 lbs	\$482.50
65850*	Cable Management Tray - 2	21 1/2" L (ea)	4 lbs	\$42.00



Please refer to p. 2 for a description of symbols.

Flip Top Cable Table

- » The Flip Top Cable Table features a unique cable management system for easy organization.
- » Back features a cable trough hidden by a "flip top" lid for easy access and concealment.
- » Available in a variety of sizes, the tables are height adjustable from 23" to 29".
- » Black powder-coated steel frame with gray laminate tops.
- » TAA compliant.

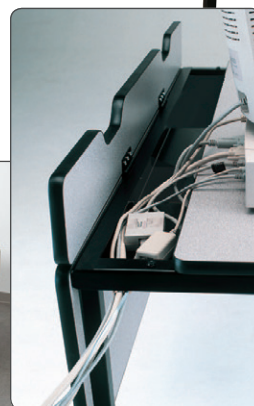
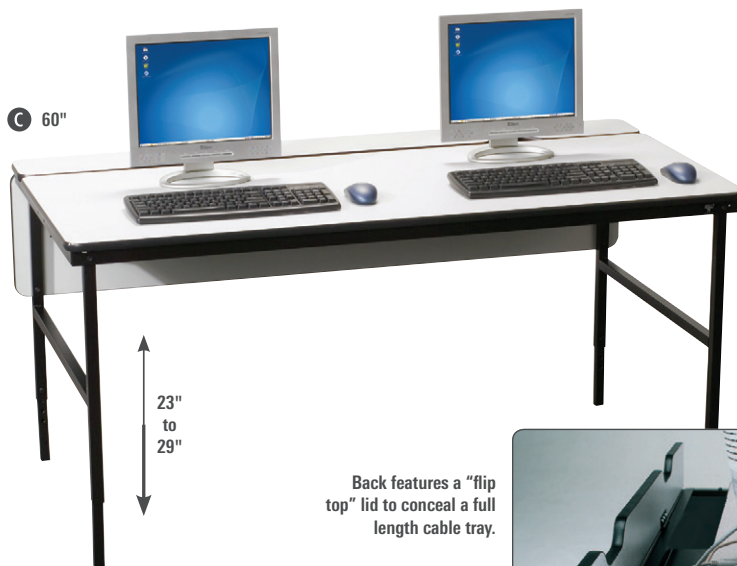

B Flip Top Cable Table - 48"		Ship Wt.	Price
Stock	Dimensions		
54980**	23" - 29"H x 48"W x 30"D	68 lbs	\$458.00
C Flip Top Cable Table - 60"		Ship Wt.	Price
Stock	Dimensions		
55280	23" - 29"H x 60"W x 30"D	85 lbs	\$560.00
D Flip Top Cable Table - 72"		Ship Wt.	Price
Stock	Dimensions		
55580	23" - 29"H x 72"W x 30"D	101 lbs	\$666.00

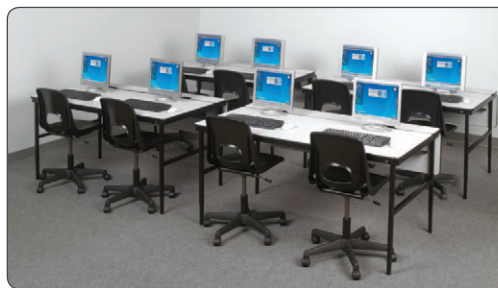



Contoured desk shape allows easy teacher-student conferencing.

Custom colors available!
see pp. 10-11.



Instructor Teacher's Desk

- » The Instructor Teacher's Desk features a tough steel design with rounded edges for comfort.
- » Thoughtful ergonomic shape allows easy student-teacher conferencing.
- » Oak or cherry laminate top is 1" thick and scratch-resistant with a grommet for easy cable management.
- » Heavy duty steel legs with locking casters.
- » Includes cabinet with three locking, full extension drawers. Largest drawer accepts standard hanging files. Box drawers include divider.



Please refer to p. 2 for a description of symbols.



Instructor Teacher's Desk		Dimensions	Ship Wt.	Price
Oak	Cherry			
■ 90127	■ 90126	29"H x 60"W x 28 1/2"D	95 lbs	\$878.68



Angle adjustable top.

A

Pop-out side shelf.

Locking storage cabinet features two adjustable shelves.



A Lectern with workstation.

Perforated modesty panel.

B Stand alone lectern.



Please refer to p. 2 for a description of symbols.

Lecture Station

- » The innovative Lecture Station combines a workstation and lectern into one convenient unit.
- » GREENGUARD Indoor Air Quality Certified® and GREENGUARD Children & Schools CertifiedSM.
- » Desktop surface (36"W x 19 3/4"D) is teak HPL. Locking drawer is 2 1/2"H x 21 1/2"W x 15"D. Lectern top (22 1/4"W x 22 1/4"D) tilts 10° and locks into place. Pop-out shelf on the side.
- » Interior (32 1/2"H x 18 1/4"W x 19 1/4"D) features two adjustable shelves and a locking door.
- » Integrated wire management conduits in the desk top and lectern body. Frame is black powder-coated steel with 3" non-marring casters.
- » TAA compliant.



1 Lecture Station - Full Workstation

Part No.	Dimensions	Ship Wt.	Price
27537	43"H x 58 1/2"W x 22 1/4"D	141 lbs	\$1,132.00

2 Lecture Station - Stand Alone Lectern

Part No.	Description	Ship Wt.	Price
27537L	43"H x 22 1/4"W x 22 1/4"D	93 lbs	\$667.88



Please refer to p. 2 for a description of symbols.



Modular Pedestal Desk

- » The Modular Pedestal Desk features a 1" thick high pressure laminate surface. Available in three standard colors. Edge banding is color coordinated.
- » GREENGUARD Indoor Air Quality Certified® and GREENGUARD Children & Schools CertifiedSM.
- » Desk includes two drawers and a full surround perforated modesty panel. Front legs include glides and back legs include casters (locking).
- » Black steel mobile filing cabinet (two drawer or three drawer) is available to fit under the desk.
- » TAA compliant.



Gray



Medium Oak



Mahogany



1" thick HPL top available in three colors.

Two drawers included.

Legs include both casters and glides to provide mobility without impairing aesthetics.



Sides and back of steel frame are perforated.

1 Modular Pedestal Desk

Gray	Medium Oak	Mahogany	Dimensions	Ship Wt.	Price
89949	89951	89952	29"H x 60"W x 28 1/2"D	95 lbs	\$499.00

2 Mobile File Cabinet

2 Drawer	Ship Wt.	3 Drawer	Ship Wt.	Dimensions	Price
27556	30 lbs	27557	35 lbs	24"H x 15"W x 23"D	\$304.50



Please refer to p. 2 for a description of symbols.

Corner Workstation

- » Add a stylish element to any environment with the modern and versatile Corner Workstation.
- » GREENGUARD Indoor Air Quality Certified® and GREENGUARD Children & Schools CertifiedSM.
- » Angled unit fits into a corner and includes a shelf for holding a monitor for easy viewing. Features a teak laminate surfaces and a silver metal frame.
- » Can be used alone, or clustered in groups of two or four to create multi-user work areas.
- » Cut-out in front provides natural arm positioning, and allows space-saving chair storage.
- » Includes freestanding CPU stand with casters for easy access and mobility.
- » TAA compliant.



A Single workstation set up.

B Group workstation set up with four Corner Workstations.

A Corner Workstation			
Part No.	Dimensions	Ship Wt.	Price
■ 89833**	42"H x 39 1/2"W x 39 1/4"D	50 lbs	\$208.00

B Corner Workstation Cluster (set of 4)			
Part No.	Description	Ship Wt.	Price
■ 89836	42"H x 79"W x 78 1/2"D	200 lbs	\$742.00



D Left Write Angle Workstation.

25 1/2"
to
33 1/2"

E



Please refer to p. 2 for a description of symbols.

Write Angle Workstation

- » The Write Angle workstation can be used individually or grouped in clusters of two or four.
- » Angled shape makes working more comfortable.
- » Height from 25 1/2" to 31 1/2" with glides, or from 27 1/2" to 33 1/2" with casters.
- » Top is equipped with two security rails.
- » Black powder-coated steel frame.
- » TAA compliant.

A Write Angle Workstation - Right			
Part No.	Dimensions	Ship Wt.	Price
■ 82253**	25 1/2" - 33 1/2"H x 39"W x 31"D	40 lbs	\$196.00

B Write Angle Workstation - Left			
Part No.	Dimensions	Ship Wt.	Price
■ 82883**	25 1/2" - 33 1/2"H x 39"W x 31"D	40 lbs	\$190.00

C Write Angle Cluster (2 Right / 2 Left)			
Part No.	Dimensions	Ship Wt.	Price
■ 82783	25 1/2" - 33 1/2"H x 78"W x 62"D	40 lbs	\$784.00

Shown with Desktop Flat Panel Monitor Mounts, p. 214.



See the complete line of Lumina™ furnishings on pages 12-15!



A Starter



B Add-On



Please refer to p. 2 for a description of symbols.

Black Cherry Lumina™ Carrel

- » The Black Cherry Lumina™ Carrel creates private and compact work areas. Begin with a starter unit and connect as many add-on units as needed.
- » Black powder-coated steel frame with laminate panels in a rich cherry finish.
- » Coordinates with other members of the Black Cherry Lumina™ series to create a custom and designer room environment.

A Black Cherry Lumina™ Carrel - Starter			
Part No.	Dimensions	Ship Wt.	Price
■ 90082	45 3/4"H x 31 1/4"W x 24"D	60 lbs	\$253.17
B Black Cherry Lumina™ Carrel - Add-On			
Part No.	Dimensions	Ship Wt.	Price
■ 90083	45 3/4"H x 31 1/4"W x 24"D	50 lbs	\$187.13



Please refer to p. 2 for a description of symbols.

Floor Carrel & Add-A-Carrel: Standard & Deluxe

- » The Floor Carrel and Add-A-Carrel create privacy for testing, studying, or other purposes.
- » Purchase a Floor Carrel to start a row, and then as many Add-A-Carrels as you need.
- » GREENGUARD Indoor Air Quality Certified® and GREENGUARD Children & Schools CertifiedSM
- » Constructed from 5/8" thick teak laminated particle board panels for superior durability.
- » Retractable keyboard shelf measures 25 1/2"H x 31 3/8"W x 11 3/4"D. Work surface measures 29"H x 31 3/8"W x 23 7/8"D.
- » Frame is black powder-coated steel and includes leveling glides.



Join Add-A-Carrels to create rows of any length!

④ Standard Floor Carrel			
Part No.	Dimensions	Ship Wt.	Price
■ 89830	48"H x 32 3/8"W x 24 1/2"D	66 lbs	\$206.00
⑤ Standard Add-A-Carrel			
Part No.	Dimensions	Ship Wt.	Price
■ 89831	48"H x 32"W x 24 1/2"D	49 lbs	\$165.00
⑥ Deluxe Floor Carrel			
Part No.	Dimensions	Ship Wt.	Price
■ 89868	48"H x 32 3/4"W x 24 1/2"D	78 lbs	\$317.33
⑦ Deluxe Add-A-Carrel			
Part No.	Dimensions	Ship Wt.	Price
■ 89869	48"H x 32"W x 24 1/2"D	61 lbs	\$270.17



Please refer to p. 2 for a description of symbols.

FNL Carrel & Add-On

- » FNL Carrel available as a starter carrel or add-on carrels in gray 3/4" particle board with HPL.
- » GREENGUARD Indoor Air Quality Certified® and GREENGUARD Children & Schools CertifiedSM
- » Overall dimensions are 46"H x 31 1/4"W x 30"D. Includes a top shelf above work space.
- » Work surface features built-in groove for holding books upright or keeping track of pens and pencils.
- » TAA compliant.



A FNL Carrel - Starter			
Part No.	Dimensions	Ship Wt.	Price
89980	46"H x 31 1/4"W x 30"D	90 lbs	\$431.52
B FNL Carrel - Add-On			
Part No.	Dimensions	Ship Wt.	Price
89981	46"H x 30 1/4"W x 30"D	72 lbs	\$319.00



www.moorecoinc.com/green
for detailed information.

A Natural Cherry



B Natural Cherry



C Putty



Please refer to p. 2 for a description of symbols.

H Carrel & Add-On

- » H Carrels are sophisticated, versatile private work areas.
- » Start with an H Carrel and then join as many add-on H Carrels as needed.
- » GREENGUARD Indoor Air Quality Certified® and GREENGUARD Children & Schools CertifiedSM
- » Constructed from 1" thick core board, the carrels are available in gray or medium oak HPL. Work surface (41 1/2"W x 29"D) angles inward 5 1/2" to save space when in use with a chair.
- » Steel frame and modesty panel. Glides are included to keep the unit level. Optional CPU holder and an optional locking cable tray door are available.
- » TAA compliant.

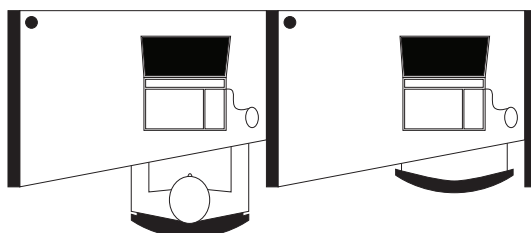

Angled tops maximize floor space.



A Gray

B Gray

C Gray

A H Carrel - Starter

Part No.	Color	Dimensions	Ship Wt.	Price
89938	Gray	42"H x 43"W x 27 3/4"D	85 lbs	\$441.38
89891	Cherry	42"H x 43"W x 27 3/4"D	85 lbs	\$565.07

B H Carrel - Add-On

Part No.	Color	Dimensions	Ship Wt.	Price
89939	Gray	42"H x 42"W x 27 3/4"D	65 lbs	\$348.39
89892	Cherry	42"H x 42"W x 27 3/4"D	65 lbs	\$465.97

C CPU Holder

Part No.	Color	Ship Wt.	Price
34585*	Gray	12 lbs	\$107.42
34468*	Putty	12 lbs	\$140.39

D Locking Cable Tray Door

Part No.	Color	Ship Wt.	Price
34584*	Gray	7 lbs	\$50.00
34467*	Putty	7 lbs	\$50.00

Carrels



Groove Carrel & Add-On

- » The Groove Carrel comes single or double sided. Begin with a starter carrel, and join as many add-on carrels as needed.
- » GREENGUARD Indoor Air Quality Certified® and GREENGUARD Children & Schools Certified™
- » Constructed of 3/4" particle board with HPL, the carrels are height adjustable from 38" to 50" in 2" increments, and feature curved end panels.
- » Includes a top shelf above work space. Work surface features built-in groove for holding books upright, or keeping track of pens and pencils.
- » TAA compliant.



Please refer to p. 2 for a description of symbols.



A Groove Carrel - Single Starter

Part No.	Color	Dimensions	Ship Wt.	Price
89977	Gray	38-50"H x 31 1/4"W x 23 3/4"D	90 lbs	\$306.27
89971	Teak	38-50"H x 31 1/4"W x 23 3/4"D	90 lbs	\$306.27

B Groove Carrel - Double Starter

Part No.	Color	Dimensions	Ship Wt.	Price
89976	Gray	38-50"H x 31 1/4"W x 54 3/4"D	135 lbs	\$479.00
89970	Teak	38-50"H x 31 1/4"W x 54 3/4"D	135 lbs	\$479.00

C Groove Carrel - Single Add-On

Part No.	Color	Dimensions	Ship Wt.	Price
89979	Gray	38-50"H x 30 1/8"W x 23 3/4"D	65 lbs	\$239.00
89973	Teak	38-50"H x 30 1/8"W x 23 3/4"D	65 lbs	\$239.00

D Groove Carrel - Double Add-On

Part No.	Color	Dimensions	Ship Wt.	Price
89978	Gray	38-50"H x 30 1/8"W x 54 3/4"D	100 lbs	\$398.00
89972	Teak	38-50"H x 30 1/8"W x 54 3/4"D	100 lbs	\$398.00





Please refer to p. 2 for a description of symbols.

Study Carrel

- » The heavy duty Study Carrel provides privacy wherever it is needed.
- » GREENGUARD Indoor Air Quality Certified® and GREENGUARD Children & Schools CertifiedSM.
- » Available in gray, oak, or walnut HPL with a white interior for a brighter work space.
- » Work surface is height adjustable from 22" to 30". Top shelf adds rigidity and provides storage area. Legs are black powder-coated steel. Leveling glides included.
- » TAA compliant. 10 year guarantee.

Study Carrel					
Part No.	Color	Dimensions	Ship Wt.	Price	
89788**	Oak	38 1/4" - 46 1/4"H x 37"W x 24"D	92 lbs	\$479.00	
89789**	Gray	38 1/4" - 46 1/4"H x 37"W x 24"D	92 lbs	\$479.00	
89790**	Walnut	38 1/4" - 46 1/4"H x 37"W x 24"D	92 lbs	\$479.00	



Please refer to p. 2 for a description of symbols.

Privacy Study Carrel

- » The Privacy Study Carrel is ideal anywhere private work areas are needed.
- » Panels are 1" thick. Work surface measures 29 1/2"W x 23 1/2"D.
- » Includes a built-in hinged metal plate to cover optional electrical assembly.
- » Optional light mounts under the top shelf to provide a brighter work area.
- » Black powder-coated steel frame. Legs feature dual cut-outs for easy cable routing.
- » TAA compliant.

A Privacy Study Carrel

Part No.	Item	Dimensions	Ship Wt.	Price
89845E**	Privacy Study Carrel	47 1/2"H x 31 1/2"W x 31 1/2"D	79 lbs	\$382.00
66568*	Optional Light		2 lbs	\$75.00



Unique rubber connectors allow the carrel to be assembled in about 5 minutes.



Please refer to p. 2 for a description of symbols.

Economical Study Carrel

- » The Economical Study Carrel is an attractive and inexpensive option for individual privacy.
- » GREENGUARD Indoor Air Quality Certified® and GREENGUARD Children & Schools CertifiedSM
- » Teak laminate side and back panels are 3/8" thick particle board. Work surface is 3/4" thick particle board and features a grommet for cable management.
- » Assembles in less than 15 minutes with innovative plastic panel connectors. Frame is black powder-coated steel and includes leveling glides.
- » TAA compliant.

B Economical Study Carrel

Part No.	Dimensions	Ship Wt.	Price
89822**	44 1/2"H x 33"W x 25"D	56 lbs	\$270.00

A



Single Tabletop Carrel



Desks not included.

Please specify color when ordering.

Round Tabletop Carrel



Single Tabletop Carrel with markerboard back panel.



Double Tabletop Carrel



Special colors available on orders of 25 or more carrels! Call for details.



Please refer to p. 2 for a description of symbols.

Study-Rite Carrels

- » Study-Rite Carrels are portable and modular, and available in a variety of configurations.
- » Tackable panels available with fabric or easy to clean vinyl surfaces.
- » Single and double carrels are available with a markerboard back panel, or with a grommet.
- » Tabletop carrels are also available in an X configuration to create four different study areas.
- » Floor carrels are available in 36" or 48" heights and can be used with desks up to 24" wide.
- » All carrels are trimmed in anodized aluminum with hinges to fold flat for compact storage.
- » Made in the USA. TAA compliant.

Vinyl Colors



Champagne (41)



Pacific Blue (47)



Gray (44)



Burgundy (42)

Fabric Colors



Crimson (58)



Granite (36)



Indigo (35)



Nutmeg (33)



Spruce (32)

Study-Rite Carrels

Teak	Item	Dimensions	Ship Wt.	Vinyl	Fabric
701*	Single Carrel (w-markerboard back panel)	16"H x 18"W x 18"D	12 lbs	\$150.36	\$181.44
702*	Single Carrel	16"H x 18"W x 18"D	10 lbs	\$119.17	\$148.99
703*	Single Carrel (w-grommet)	16"H x 18"W x 18"D	9 lbs	\$145.23	\$175.05
704*	Double Carrel (w-markerboard back panel)	16"H x 36"W x 18"D	17 lbs	\$248.35	\$304.97
705*	Double Carrel	16"H x 36"W x 18"D	15 lbs	\$183.83	\$241.82
706*	Double Carrel (w-grommet)	16"H x 36"W x 18"D	12 lbs	\$233.66	\$274.16
707*	Round Carrel	16"H x 36"W x 36"D	10 lbs	\$122.24	\$153.74
708*	Round Carrel	16"H x 42"W x 42"D	10 lbs	\$135.57	\$160.13
709**	Round Carrel	16"H x 48"W x 48"D	12 lbs	\$145.23	\$175.92
710**	Floor Carrel	36"H x 25"W x 24"D	25 lbs	\$229.04	\$308.23
711**	Floor Carrel	48"H x 25"W x 24"D	29 lbs	\$283.93	\$398.45



Contoured back panel.

A



Padded and upholstered seat



Provides ample writing space for right or left handed users.



Please refer to p. 2 for a description of symbols.



Nesting Stacking Tablet Chairs

- » Nesting Stacking Tablet Chairs are ideal for classrooms, training rooms, or anywhere quick assemblies or meetings are needed.
- » Uniquely shaped tablet arm (25"W x 13 1/2"D) provides ample writing space for right or left hand use, or for use with a laptop or tablet.
- » Unique and durable tablet arm mechanism withstands rigorous use. Tablet folds up and over quickly with one hand operation.
- » Chairs stack and nest for easy mobility and compact storage.
- » TAA compliant. Sold in sets of two.



Stack or nest for easy mobility and space saving storage.

⊕ Nesting Stacking Tablet Chair (Set of 2)

Part No.	Dimensions	Ship Wt.	Price
66625*	31 3/4"H x 26 1/2"W x 22 1/2"D	32 lbs	Call



Please refer to p. 2 for a description of symbols.

Oui Chair

- » Elegant and stylish, the Oui Chair is ideal for public and private reception areas.
- » Features clean lines and curves made to fit the human form.
- » Polypropylene back and seat with an enhanced nylon armrest.
- » Stacks for easy and compact storage.
- » Sold in sets of four. TAA compliant.

4 Oui Chair - Set of 4

Part No.	Dimensions	Ship Wt.	Price
■ 34717	31 1/2"H x 22 1/4"W x 22 1/2"D	64 lbs	\$646.40



Made with 30% recycled content!

A



Please refer to p. 2 for a description of symbols.



Renew Stack Chair

- » The Renew Chair is a high-density stacking chair made with 30% recycled content.
- » Multipurpose chairs can be conveniently used in waiting rooms, guest/reception areas, conference rooms, and training rooms. Sold in sets of four.
- » Seat measures 18" wide.
- » The best in comfort, durability and long-lasting quality.

Renew Stack Chair - Set of 4

Part No.	Dimensions	Ship Wt.	Price
34725	33"H x 20"W x 19"D	48 lbs	Call



Ventilation holes add style and breathability!

Circulation stack chairs available in gray or black.



Circulation stack chairs sold in sets of 4.

Stack up to 8 chairs high!



Please refer to p. 2 for a description of symbols.

Circulation Stack & Computer Chair

- » The Circulation Stack chair marries style and comfort in a unique, modern package.
- » The seat and back are black or gray injection-molded polypropylene contoured to provide a comfortable fit. Perforations allow for easy seat and back breathability.
- » Available in sets of two or four chairs. Add a set of optional casters and create a computer task chair. Optional arms are available separately, and require assembly to the chair.
- » TAA compliant.



Stack chair shown with optional casters., making it an ideal computer chair!



Optional Arm Kit (1 pair)

Optional Stack Casters (sold in sets of 16)



A Circulation Stack Chair - Gray (Set of 4)			
Part No.	Dimensions	Ship Wt.	Price
34553*	39 1/2"H x 28"W x 21"D	48 lbs	\$583.10
B Circulation Stack Chair - Black (Set of 4)			
Part No.	Dimensions	Ship Wt.	Price
34554*	39 1/2"H x 28"W x 21"D	48 lbs	\$583.10
C Stack/Computer Chair Casters			
Part No.	Item	Ship Wt.	Price
34644*	Castors (set of 16)	5 lbs	\$58.00
D Circulation Arm Kit			
Part No.	Item	Ship Wt.	Price
34555*	Arms (1 pair)	3 lbs	\$39.32



Self-adjusting spring-back lumbar support panel enables Reflex® to match the natural curvature of the spine.



Spring-backed lumbar support panel.

Reflex® Guest Chairs sold in sets of 4.

Steel base includes non-marring plastic feet that gang together.



Please refer to p. 2 for a description of symbols.

Reflex® Guest Chair

- » The Reflex® Guest Chair features an innovative spring-backed self-adjustable lumbar panel.
- » Panel automatically adjusts to the curve of the user's spine, providing unmatched fit.
- » Seat (17"H x 17 1/2"W x 18"D) and seat back (15"H x 19 1/2"W) are durable contoured plastic on a steel frame.
- » Available in black. Chairs are sold in sets of four and come fully assembled.
- » Ganging device is included to connect chairs.
- » TAA compliant.



Dolly holds up to 10 chairs for easy transport.



Also available in blue and burgundy.



Gangers included.



A Reflex® Guest Chairs (Set of 4) - Black			
Part No.	Dimensions	Ship Wt.	Price
■ 34428*	33 1/4"H x 19 1/2"W x 19"D	48 lbs	\$616.80
B Reflex® Guest Chairs (Set of 4) - Blue			
Part No.	Dimensions	Ship Wt.	Price
■ 34432*	33 1/4"H x 19 1/2"W x 19"D	48 lbs	\$576.45
C Reflex® Guest Chairs (Set of 4) - Burgundy			
Part No.	Dimensions	Ship Wt.	Price
■ 34439*	33 1/4"H x 19 1/2"W x 19"D	48 lbs	\$576.45
D Optional Reflex® Chair Dolly			
Part No.	Item	Ship Wt.	Price
■ 34429*	Dolly (holds 10 chairs)	24 lbs	\$172.00

A

Optional back rest made with 8-ply veneer and curved for comfort.



Gray

1" thick solid wood seat.

Two screws adjust each leg in height from 18" to 29 1/2".

18" to 29 1/2"

Optional back rest can be stored under the seat when not in use.



Metal nut inserts hold the seat to the frame to prevent loosening and wood splitting.



Please refer to p. 2 for a description of symbols.



Black

Lab Stool

- » The Lab Stool is an attractive, durable, and practical seating choice.
- » Solid wood seat (12 1/4" x 1") is height adjustable from 18 1/2" to 29" in 1 1/2" increments.
- » Leveling glides are included.
- » Metal nut inserts in the seat prevent loosening and wood splitting.
- » Frame is black or gray powder-coated steel with a footrest.
- » Optional back made from 8-ply veneer (6 1/4"H x 11 1/2"W). Stores under the seat.
- » TAA compliant. 10 year guarantee.

A Lab Stool

Stock	Item	Dimensions	Ship Wt.	Price
■ 34419R*	Lab Stool - Gray	18" - 29 1/2"H x 16 1/4"W x 16 1/4"D	17 lbs	\$181.00
■ 34441R*	Lab Stool - Black	18" - 29 1/2"H x 16 1/4"W x 16 1/4"D	17 lbs	\$181.00
■ 34450*	Opt Back Rest - Gray	6 1/4"H x 11 1/2"W	4 lbs	\$66.00
■ 34451*	Opt Back Rest - Black	6 1/4"H x 11 1/2"W	4 lbs	\$66.00



Please refer to p. 2 for a description of symbols.

Ventilation holes add style and breathability!



Task chair shown with optional arms.

17"
to
20"

Circulation Task Chair

- » The Circulation Task chair adds a unique, modern element to any environment.
- » Seat and back are injection-molded polypropylene contoured to provide a comfortable fit.
- » Seat features a 16° slope to provide natural support, and is height adjustable from 17" to 20".
- » Ventilation holes are stylish and functional, providing excellent seat and back breathability.
- » Includes a 5-star base with 2" casters. Assembles in less than 15 minutes.
- » Optional arms made from 7/8" tubular silver steel are available.
- » TAA compliant.

Quick and easy UPS shipping!



Optional Arm Kit (1 pair)



Default circulation task chair.

Circulation Chair Arm Kit

- » Add the optional arm kits to any Circulation Chair

Circulation Stool

- » The Circulation Stool combines style and comfort in a unique, modern package.
- » Black or gray polypropylene seat and back, contoured for natural support and comfort.
- » Attractive and functional ventilation holes provide excellent seat and back breathability.
- » Seat features a 16° slope for a natural seating position
- » Pneumatically adjustable from 20 1/2" to 28 1/2" high.
- » Foot rest is provided for comfort. Stool rolls easily on a 5-star base with 2" casters.
- » Optional arms made from 7/8" tubular silver steel are available separately.
- » TAA compliant.



Gray



Black

A Circulation Task Chair				
Part No.	Dimensions	Ship Wt.	Price	
■ 34552*	37 3/4"H x 25"W x 23 3/4"D	24 lbs	\$268.52	
B Circulation Arm Kit				
Part No.	Item	Ship Wt.	Price	
■ 34555*	Arms (1 pair)	3 lbs	\$39.32	
C Circulation Stool				
Stock	Item	Dimensions	Ship Wt.	Price
■ 34643	Circulation Stool - Black	28 1/2" - 46 1/2"H x 26"W x 26"D	38 lbs	\$294.00
■ 34642	Circulation Stool - Gray	28 1/2" - 46 1/2"H x 26"W x 26"D	38 lbs	\$294.00



Please refer to p. 2 for a description of symbols.

Trax Stool

- » The Trax Stool features a self-skinned urethane seat and back with an industrial pattern.
- » Swiveling seat measures 17"W x 16 1/2"D and adjusts in height from 22" to 32".
- » Chrome footrest is independently height adjustable.
- » 5-star nylon resin reinforced base with dual-wheel casters.
- » May be TAA compliant.

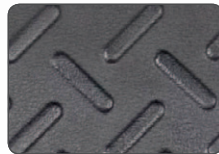

Seat and back feature unique modern industrial molded pattern.



A Trax Stool		Dimensions	Ship Wt.	Price
Stock	Item			
■ 34430*	Trax Stool	37" - 47"H x 18 1/2"W x 18 1/2"D	37 lbs	\$294.00



Please refer to p. 2 for a description of symbols.

Stacking Stool

- » Stylish Stacking Stool features a comfortable contoured seat and back and a durable black powder-coated steel frame.
- » Ideal for instructor usage in training and conference rooms.
- » Seat measures 29"H. Angled base width provides stability.
- » Stacks for easy storage. Coordinates with Nesting Stacking Chair.
- » TAA compliant.



A Stacking Stool		Dimensions	Ship Wt.	Price
Stock	Item			
■ 34716*	Stacking Stool	42 3/4"H x 21 1/2"W x 24"D	19 lbs	\$274.85



Please refer to p. 2 for a description of symbols.



Step Stool

- » Step Stool features hidden spring-loaded casters to make mobility easy, while the bumper protects your walls and furniture.
- » Casters retract when weight is applied, creating a stable step surface.
- » Sturdy stool supports up to 330 lbs and features slip-resistant surfaces.
- » No assembly required.



Step Stool

Part No.	Description	Dimensions	Ship Wt.	Price
■ 34723*	Step Stool	16 1/2"H x 16 1/2"W x 16 1/2"D	9 lbs	\$82.00



Please refer to p. 2 for a description of symbols.



KD Book Truck

- » Transport hundreds of books with ease with the KD Book Truck.
 - » Shelves are 17 1/2"D and slant inward to hold books securely.
 - » Bottom shelf is flat for additional storage.
 - » 5" casters and handles on each side.
- Durable steel construction.



KD Book Truck

Part No.	Dimensions	Ship Wt.	Price
■ 27507*	45 1/2"H x 37"W x 18"D	81 lbs	\$438.00



Please refer to p. 2 for a description of symbols.



TG-LAM

- » The TG-LAM Laminator Stand will accommodate most standard desktop laminators.
- » Top shelf measures 42"W x 26"D and is finished in scratch-resistant gray laminate.
- » Wire rack (25"D) stores items to be laminated, and film rack holds rolls of film up to 27" wide.
- » Gray powder-coated steel frame with 2" casters (two locking).
- » May be TAA compliant.

TG-LAM

Part No.	Dimensions	Ship Wt.	Price
■ 12101*	27"H x 42"W x 26"D	49 lbs	\$311.64

Desk Accessories



- A** Locking CPU Holder - Dual combination locks secure CPU.
- B** Mobile CPU Trolley - Adjusts horizontally and includes casters.
- C** Hanging CPU Holder - Holds horizontal or vertical CPUs.



Desk Accessories				
Stock	Item	Dimensions	Ship Wt.	Price
A ■ 66559*	Locking CPU Holder	9" - 13 1/4"H x 17 1/4" - 20"W	11 lbs	\$104.99
B ■ 32911*	Mobile CPU Trolley	9"H x 6 1/2" - 9 1/2"W x 10 1/2"D	6 lbs	\$61.00
C ■ 33550*	Hanging CPU Holder	5 1/8" - 13 1/8"H x 9 1/8" - 25 3/4"W	5 lbs	\$77.00

Cable Management Tray

- » The Cable Management Tray mounts to the bottom of a workstation for instant cable control.
- » Durable tray is constructed of black powder-coated steel and is generously sized.
- » Order two or more for longer workstations.
- » TAA compliant.



Please refer to p. 2 for a description of symbols.

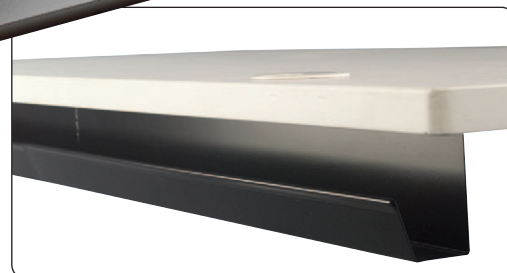

Mounts beneath a workstation for instant cable management!

Cable Management Trays				
Part No.	Description	Dimensions	Ship Wt.	Price
■ 66350*	Cable Management Tray (1)	21 1/2" long	2 lbs	\$28.00
■ 65850*	Cable Management Tray (2)	21 1/2" long	4 lbs	\$42.00

Electrical Assemblies



- E** Surge Protector with 6 outlets and 6' cord. UL/CSA.
- F** Electrical assembly with 4 outlets, 25' cord, and winder. UL/CSA.
- G** Electrical assembly with 7 outlets, 25' cord and winder. UL/CSA.
- H** Electrical assembly with 7 outlets, 25' cord and bracket. UL/CSA.

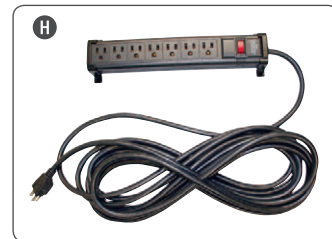

Electrical Assemblies				
Stock	Item	Dimensions	Ship Wt.	Price
E ■ 64320*	Surge Protector	6-outlet / 6' cord	1 lb	\$57.00
F ■ 66450*	Electrical Assembly	4-outlet / 25' cord / winder	4 lbs	\$62.00
G ■ 66572*	Electrical Assembly	7-outlet / 25' cord / winder	8 lbs	\$88.00
H ■ 66573*	Electrical Assembly	7-outlet / 25' cord / brackets	8 lbs	\$80.00



Red
9 1/2" seat

Scan this QR code to watch this product's online video.



Find out more online!
youtube.com/moorecoins



Green
7 1/2" seat



Red
11 1/2" seat



Royal Blue
13 1/2" seat



Green
15 1/2" seat

Age	Chair Height	Table Height
2	7 1/2 - 9 1/2"	14 1/2 - 19 1/2"
3	9 1/2 - 11 1/2"	16 1/2 - 21 1/2"
4	11 1/2 - 13 1/2"	18 1/2 - 23 1/2"
5-6	13 1/2 - 15 1/2"	20 1/2 - 24 1/2"
7-8	15 1/2"	22 1/2 - 24 1/2"



All-welded steel supports.

Is Please refer to p. 2 for a description of symbols.



Brite Kids® Chairs

- » The Brite Kids® Chair was designed with both the teacher and student in mind.
- » Steel frame supports from the bottom, allowing an adult (up to 300 lbs) to use the chair.
- » Plastic boots protect floor surfaces.
- » Available in three child-friendly colors: fire engine red, grass green, or royal blue.

Brite Kids® Chairs - Set of 4

Seat Height	Red	Green	Blue	H x W x D	Ship Wt.	Price
7 1/2"H	■ 34480	■ 34498	■ 34516	18 3/4"H x 15 1/2"W x 14"D	22 lbs	\$190.51
9 1/2"H	■ 34481	■ 34499	■ 34517	20 3/4"H x 15 1/2"W x 14 3/4"D	25 lbs	\$195.05
11 1/2"H	■ 34482	■ 34500	■ 34518	22 1/2"H x 15 3/4"W x 15 1/2"D	29 lbs	\$208.66
13 1/2"H	■ 34483	■ 34501	■ 34519	25"H x 16"W x 18"D	33 lbs	\$217.73
15 1/2"H	■ 34484	■ 34502	■ 34520	26 1/2"H x 16"W x 21"D	37 lbs	\$249.48



Horseshoe shape table shown in green.



Flower shape table shown in royal blue.



Square



Round

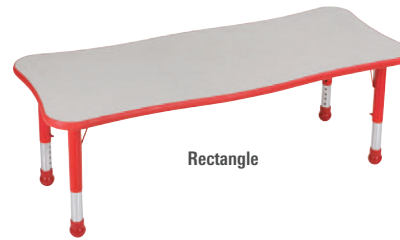

Rectangle

Age	Chair Height	Table Height
2	7 1/2" - 9 1/2"	14 1/2" - 19 1/2"
3	9 1/2" - 11 1/2"	16 1/2" - 21 1/2"
4	11 1/2" - 13 1/2"	18 1/2" - 23 1/2"
5-6	13 1/2" - 15 1/2"	20 1/2" - 24 1/2"
7-8	15 1/2"	22 1/2" - 24 1/2"



Brite Kids® Colors:

Red

Green

Blue

Please refer to p. 2 for a description of symbols.



Brite Kids® Tables

- » Brite Kids® Tables bring bright and functional furniture into any early childhood environment.
- » Available in seven shapes and sizes to fit any area. Height adjustable from 14 1/2" to 24 1/2".
- » Plastic boots on sturdy steel legs protect floor surfaces.
- » Available in three child-friendly colors: fire engine red, grass green, and royal blue.

Recommended seating per shape:

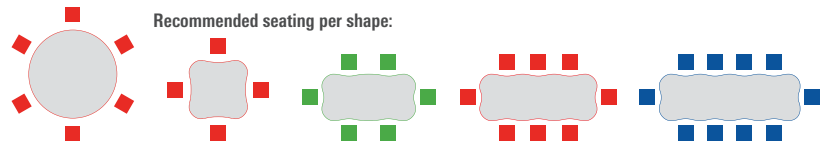

Brite Kids® Tables Shape	Red	Green	Blue	H x W x D	Ship Wt.	Price
Square	■ 34486	■ 34504	■ 34522	14 1/2" - 24 1/2"H x 30"W x 30"D	35 lbs	\$216.19
Round	■ 34490	■ 34508	■ 34526	14 1/2" - 24 1/2"H x 48"W x 48"D	66 lbs	\$373.37
Horseshoe	■ 34491	■ 34509	■ 34527	14 1/2" - 24 1/2"H x 72"W x 48"D	77 lbs	\$483.44
Flower	■ 34492	■ 34510	■ 34528	14 1/2" - 24 1/2"H x 72"W x 48"D	66 lbs	\$397.88
Small Rectangle	■ 34621	■ 34624	■ 34627	14 1/2" - 24 1/2"H x 48"W x 30"D	43 lbs	\$323.19
Med. Rectangle	■ 34622	■ 34625	■ 34628	14 1/2" - 24 1/2"H x 60"W x 30"D	49 lbs	\$374.22
Large Rectangle	■ 34623	■ 34626	■ 34629	14 1/2" - 24 1/2"H x 72"W x 30"D	55 lbs	\$425.25



Please refer to p. 2 for a description of symbols.

Brite Kids® Book Stand

- » The Brite Kids® Book Stand provides bright color and functional storage space.
- » Five level book stand allows a clear view of books, coloring books, or other materials.
- » Sturdy laminate construction is easy to clean for a sanitary surface.
- » Available in three child-friendly colors: fire engine red, grass green, and royal blue.

Brite Kids®
Colors:



Red



Green



Blue



Brite Kids® Book Stand

Red	Green	Blue	H x W x D	Ship Wt.	Price
■ 34496	■ 34514	■ 34532	29"H x 37"W x 14"D	58 lbs	\$311.02



Please refer to p. 2 for a description of symbols.

Brite Kids® 8 Compartment Storage Unit

- » Brite Kids® Storage Units provide versatile and spacious storage options in bright colors.
- » Tubs available separately.
- » Sturdy laminate shelving is easy to wipe down for a sanitary surface.
- » Available in three child friendly colors: fire engine red, grass green, and royal blue.



Tubs available separately.

Brite Kids® 8 Compartment Storage Unit						
Seat Height	Red	Green	Blue	H x W x D	Ship Wt.	Price
Storage Unit	■ 34495	■ 34513	■ 34531	35 ½"H x 47 ¼"W x 15 ½"D	110 lbs	\$512.62
Large Tub	■ 34562	■ 34563	■ 34564	8 ¼"H x 10 ¼"W x 13 ¾"D	2 lbs	\$18.14



Tubs available separately.



Please refer to p. 2 for a description of symbols.

Brite Kids® 9 Compartment Storage Unit

- » Brite Kids® Storage Units provide versatile and spacious storage options in bright colors.
- » Tubs available separately.
- » Sturdy laminate shelving is easy to wipe down for a sanitary surface.
- » Available in three child friendly colors: fire engine red, grass green, and royal blue.



Brite Kids® 9 Compartment Storage Unit						
Seat Height	Red	Green	Blue	H x W x D	Ship Wt.	Price
Storage Unit	■ 34493	■ 34511	■ 34529	35 ½"H x 47 ¼"W x 15 ½"D	110 lbs	\$512.62
Small Tub	■ 34566	■ 34567	■ 34568	4 ¼"H x 10 ¼"W x 13 ¾"D	2 lbs	\$13.61
Large Tub	■ 34562	■ 34563	■ 34564	8 ¼"H x 10 ¼"W x 13 ¾"D	2 lbs	\$18.14

Early Childhood Storage & Organization



Please refer to p. 2 for a description of symbols.

Brite Kids® 24 Compartment Storage Unit

- » Brite Kids® Storage Units provide versatile and spacious storage options in bright colors.
- » Tubs available separately.
- » Sturdy laminate shelving is easy to wipe down for a sanitary surface.
- » Available in three child friendly colors: fire engine red, grass green, and royal blue.

Brite Kids® Colors:



Red



Green



Blue



Tubs available separately.

Brite Kids® 24 Compartment Storage Unit

Seat Height	Red	Green	Blue	H x W x D	Ship Wt.	Price
Storage Unit	■ 34647	■ 34649	■ 34651	35 ½"H x 47 ¼"W x 15 ½"D	180 lbs	\$646.92
Small Tub	■ 34566	■ 34567	■ 34568	4 ¼"H x 10 ¼"W x 13 ¾"D	2 lbs	\$13.61



Please refer to p. 2 for a description of symbols.

Brite Kids® Coat Locker

- » The Brite Kids® Coat Locker provides organized storage for children's belongings.
- » Coat hanging area (25 1/4"H x 10 3/4"W x 13 3/8"D) includes a hook on each side.
- » Bottom cubby area (9 7/8"H x 10 3/4"W x 13 3/8"D) is ideal for storing school supplies.
- » Sturdy laminate shelving is easy to wipe down for a sanitary surface.
- » Available in three child friendly colors: fire engine red, grass green, or royal blue.
- » Optional tubs for bottom cubby area available.

Brite Kids® Colors:



Red



Green



Blue



Tubs available separately.

Brite Kids® Coat Locker

Seat Height	Red	Green	Blue	H x W x D	Ship Wt.	Price
Coat Locker	■ 34648	■ 34650	■ 34652	35 ½"H x 60"W x 15 ½"D	200 lbs	\$729.00
Large Tub	■ 34562	■ 34563	■ 34564	8 ¼"H x 10 ¼"W x 13 ¾"D	2 lbs	\$18.14

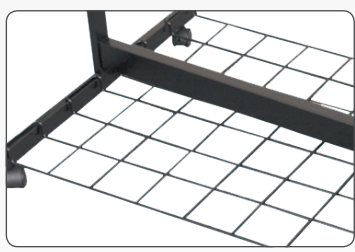

Pack Rack Basket sold separately.



Please refer to p. 2 for a description of symbols.

Pack Rack

- » The Pack Rack keeps coats, jackets, backpacks, and rain gear organized and out of the way.
- » Black powder-coated steel frame includes 20 hooks and 2" casters (two locking).
- » Optional basket mounts to the bottom to keep wet or muddy shoes off the floor.



Shown with Pack Rack Basket.

Pack Rack				
Part No.	Item	Dimensions	Ship Wt.	Price
■ 24851*	Pack Rack	42"H x 32"W x 24"D	23 lbs	\$208.00
■ 33650*	Pack Rack Basket	1 1/2"H x 32"W x 24"D	9 lbs	\$52.00

Makes storing and transporting athletic equipment easy!



Please refer to p. 2 for a description of symbols.

Sports Tower

- » The Sports Tower saves time and effort moving bulky athletic equipment to and from practice.
- » Stores up to 24 balls and keeps all equipment organized and easy to find.
- » Netting is secured to the frame with industrial grade hook-and-loop straps for durability.
- » Frame is white powder-coated steel carries a ten year guarantee.
- » Includes 3" casters (2 locking) for easy mobility.

Sports Tower			
Part No.	Dimensions	Ship Wt.	Price
■ 810**	36"H x 35"W x 14 1/2"D	30 lbs	\$316.62

Melamine dry erase surface on each end.



Mixed array of red and blue tubs included!



Please refer to p. 2 for a description of symbols.

Tubbie Tower

- » The Tubbie Tower provides ample storage for any early childhood environment.
- » Nine red and blue recyclable plastic tubs are included with the cart
- » Each end of the cart includes a melamine dry erase panel for even more functionality.
- » White powder-coated steel frame carries a ten year guarantee.
- » Includes 3" casters (2 locking) for easy mobility.

Tubbie Tower			
Part No.	Dimensions	Ship Wt.	Price
■ 788**	36"H x 35"W x 14 1/2"D	54 lbs	\$355.15

Early Childhood Room Dividers & Display Panels



See p. 220 for all vinyl color choices!



Please refer to p. 2 for a description of symbols.

Preschool Dividers

- » Preschool Dividers are the ideal portable panel for any early childhood environment.
- » Use the panels as room dividers, acoustical shields, storyboard displays, or to exhibit artwork.
- » Join dividers together to create private learning areas, or to divide rooms into activity areas.
- » Available finished in black flannel, easy to clean vinyl, or melamine dry erase surface.
- » Lightweight panel and wide base design create stability. Black anodized aluminum trim.
- » Panels include 2" casters (2 locking).
- » Made in the USA. TAA compliant.



Preschool Dividers

Surface Combination	4'H x 4'W	Ship Wt.	Price	4'H x 5'W	Ship Wt.	Price	4'H x 6'W	Ship Wt.	Price
Vinyl / Vinyl	646D	35 lbs	\$247.35	646F	42 lbs	\$293.49	646G	50 lbs	\$341.44
Flannel / Flannel	647D	35 lbs	\$247.35	647F	42 lbs	\$293.49	647G	50 lbs	\$341.44
Markerboard / Vinyl	648D	35 lbs	\$330.24	648F	42 lbs	\$397.22	648G	50 lbs	\$465.90
Markerboard / Flannel	649D	35 lbs	\$330.24	649F	42 lbs	\$397.22	649G	50 lbs	\$465.90
Markerboard / Markerboard	650D	35 lbs	\$381.91	650F	42 lbs	\$502.52	650G	50 lbs	\$591.91



Magnetic accessory pad included.

Four recyclable plastic tubs for storage included.



Reverse side



Blow mold accessory tray.



Please refer to p. 2 for a description of symbols.

TLC-2

- » The TLC-2 is a mobile classroom on wheels, ideal for any educational environment.
- » Features a dry erase surface that doubles as a magnetic bulletin board.
- » Wire big book holder, metal storage tray, and four recyclable plastic tubs included.
- » Red blow mold plastic tray is included for accessories, and attaches with wire hooks.
- » Magnetic accessory pad with permanently fused penmanship lines is included with the TLC-2.
- » Frame is white powder-coated steel with 2" locking casters.

TLC-2 Part No.	Dimensions	Ship Wt.	Price
805**	55 1/2"H x 30"W x 26 3/4"D	69 lbs	\$419.30

Early Childhood Easels



Four recyclable plastic storage tubs included.

3" locking casters.



Please refer to p. 2 for a description of symbols.



Cart Wheasel®

- » The Cart Wheasel® provides a writing surface and storage in a small footprint.
- » Melamine dry erase surface hangs on two hooks, which can also be used to hold flip charts.
- » Accessory tray can be attached on either side of the unit.
- » Central storage shelf and four recyclable plastic storage tubs are included.
- » Frame is white powder-coated steel and includes 3" heavy duty locking casters.

Cart Wheasel® Part No.	Dimensions	Ship Wt.	Price
■ 782**	65 ½"H x 27"W x 17 ½"D	54 lbs	\$290.68



Magnetic markerboard surface

Magnetic chalkboard surface



Please refer to p. 2 for a description of symbols.



White MICE Wheasel®

- » The White MICE Wheasel® is ideal for an early childhood environment.
- » Magnetic dry erase surface and magnetic chalkboard surface.
- » Includes a magnetic ledge with pegs to hold books up for story time.
- » Frame is white powder-coated steel, and carries a ten year guarantee.
- » Includes 2" locking casters. Folds for compact and convenient storage.

White MICE Wheasel® Part No.	Dimensions	Ship Wt.	Price
■ 803**	45"H x 24 ½"W x 27"D	49 lbs	\$237.13



Please refer to p. 2 for a description of symbols.

Baby Folding Wheasel®

- » The Baby Folding Wheasel® is a classroom on wheels, storing and transporting materials.
- » Two dry erase markerboard surfaces measure 29 3/4"W x 43"H with a tray on each.
- » Wire book rack included to hold books upright.
- » Available with a storage tray, or with a rack with four recyclable plastic storage tubs.



with tubs



with tray

Baby Folding Wheasel®

Part No.	Item	Dimensions	Ship Wt.	Price
784T**	BFW w/tubs	57"H x 30 1/2"W x 34"D	66 lbs	\$347.35
784**	BFW w/tray	57"H x 30 1/2"W x 34"D	71 lbs	\$298.75



Please refer to p. 2 for a description of symbols.

MFE on Wheels

- » Colorful and functional, the MFE (Magnetic Flannel Easel) on Wheels is ideal for any early childhood environment.
- » Red magnetic flannel surface on one side, and magnetic dry erase surface on the other.
- » Storage tray is included between the two surfaces.
- » Magnetic book ledge is included to hold big books.
- » Frame is blue powder-coated steel with 2" locking casters. Folds for storage.



White magnetic dry erase surface



Red magnetic flannel surface

MFE on Wheels

Part No.	Dimensions	Ship Wt.	Price
749M**	45"H x 24 1/2"W x 27"D	43 lbs	\$247.84

Early Childhood Easels



Please refer to p. 2 for a description of symbols.

Magnetic Flannel Easel

- » The Magnetic Flannel Easel is a useful and fun addition to any early childhood environment.
- » One side features a magnetic red flannel surface. Other side features a dry erase surface.
- » Storage shelf is provided between the surfaces.
- » Magnetic book ledge included.
- » Framed in solid wood. Folds for convenient storage.
- » May be TAA compliant.

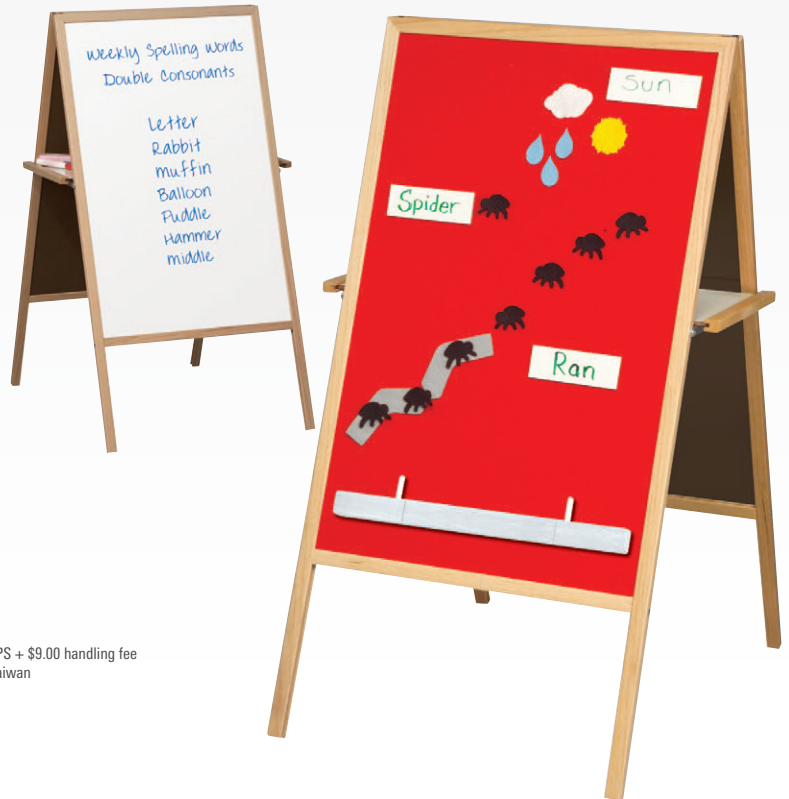

No assembly required!

Magnetic Flannel Easel

Part No.	Dimensions	Ship Wt.	Price
749*	47"H x 24"W	29 lbs	\$225.27

**Ships UPS + \$9.00 handling fee
Made In Taiwan



Please refer to p. 2 for a description of symbols.

Multifunctional Language Easel

- » The Multifunctional Language Easel is a great addition to any early childhood environment.
- » Magnetic dry erase surface on one side. Blue hook-and-loop fabric on the other.
- » Includes magnetic book ledge to hold books up for easy viewing during story time.
- » Set of 24 dry erase cards included helps with language or spelling lessons.
- » Solid wood frame folds for compact storage.
- » May be TAA compliant.

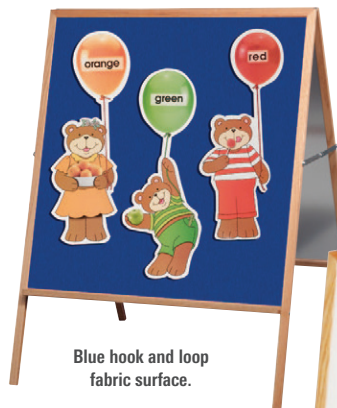

Blue hook and loop fabric surface.



White magnetic dry erase surface.

No assembly required!

Multifunctional Language Easel

Part No.	Dimensions	Ship Wt.	Price
746*	47"H x 35"W	43 lbs	\$340.98



Please refer to p. 2 for a description of symbols.

6-n-1 Easel

- » The multifunctional 6-n-1 Easel is a useful addition to any classroom.
- » Magnetic Lightning board surface and red flannel tackboard surface.
- » Use as a markerboard, a chalkboard, a magnetic board, a tackboard, a surface for Velcro® and flannel manipulatives, and as a big book holder using the included magnetic book ledge.
- » Easel features a solid wood frame and folds flat for storage.

6-n-1 Easel			
Part No.	Dimensions	Ship Wt.	Price
748*	47"H x 24"W	28 lbs	\$193.01

No assembly required!



Red flannel surface is tackable and ideal for flannel manipulatives.



Lightning board surface can be used as a markerboard, chalkboard, magnetic board, or as a big book holder.

Magnetic book holder included.

Early Childhood Easels



Please refer to p. 2 for a description of symbols.

Teacher's Magnetic Instructional Easel (TMIE)

- » The TMI is a versatile addition to any educational environment.
- » Magnetic dry erase markerboard on one side and magnetic chalkboard on the other.
- » White magnetic book ledge is included to hold books up for easy viewing during story time.
- » Storage tray located between the two surfaces.
- » Solid wood trim folds flat for compact storage.
- » May be TAA compliant.



No assembly required!

TMI Part No.	Dimensions	Ship Wt.	Price
75T*	47"H x 24"W	29 lbs	\$245.29



Please refer to p. 2 for a description of symbols.

Teacher's Magnetic Instructional Easel - Wide (TMIW)

- » The TMIW is a fun and useful addition to any educational environment.
- » Magnetic dry erase surface on one side and magnetic chalkboard surface on the other.
- » High profile makes it easier for a teacher to use and for students to see.
- » White magnetic book ledge is included to hold books up for easy viewing during story time.
- » Solid wood trim folds flat for compact storage.
- » May be TAA compliant.



No assembly required!

TMIW Part No.	Dimensions	Ship Wt.	Price
75TW*	47"H x 35"W	36 lbs	\$243.06



Please refer to p. 2 for a description of symbols.

2-n-1 Tabletop Easel

- » The 2-n-1 Tabletop Easel is ideal for teaching in small groups.
- » Features both a magnetic chalkboard and magnetic dry erase markerboard.
- » Frame is solid wood and includes pegs on each side to hold books for story time.
- » Folds flat for storage.
- » May be TAA compliant.

2-n-1 Tabletop Easel

Part No.	Dimensions	Ship Wt.	Price
751**	19 1/2"H x 18"W	10 lbs	\$58.76



Solid wood trim.

Magnetic chalkboard surface.

Magnetic markerboard surface.

Pegs on each side to hold books open.



Please refer to p. 2 for a description of symbols.

Ideal for group learning or small display areas!

Folding Tabletop Board

- » The Folding Tabletop Board is perfect for group activities or for small display areas
- » Features a full-length pinch-proof piano hinge, protecting small fingers from injury.
- » Black flannel surface is trimmed in satin anodized aluminum. Folds for storage.

Folding Tabletop Board

Part No.	Dimensions	Ship Wt.	Price
725GB*	24"H x 36"W	7 lbs	\$80.71



Black flannel surface.

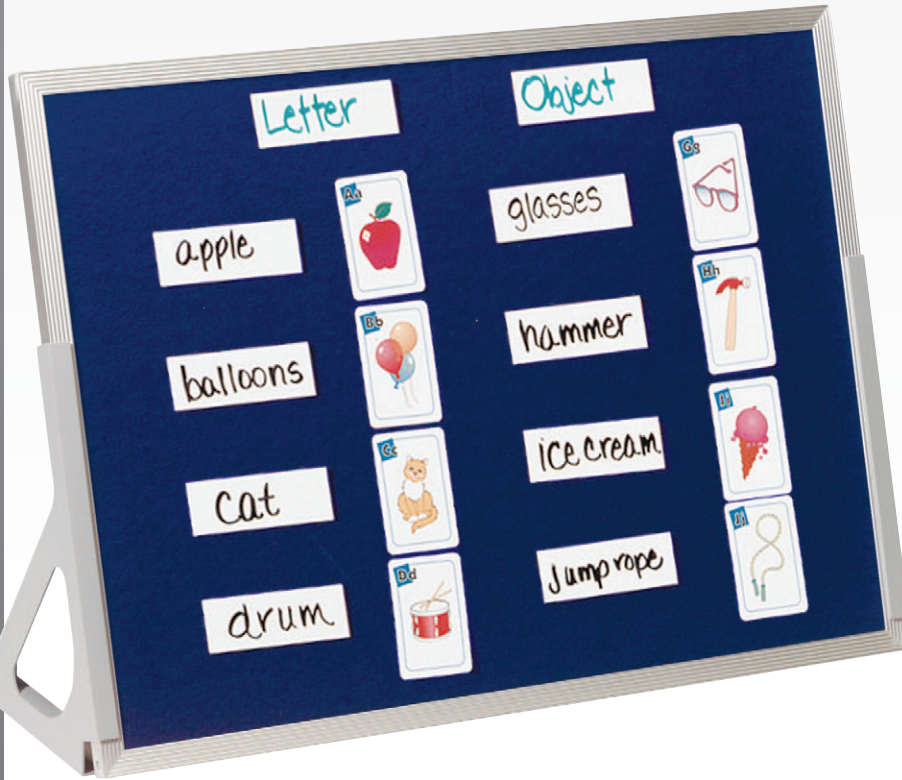

Please refer to p. 2 for a description of symbols.

Hook & Loop Tabletop Easel

- » The Hook & Loop Tabletop Easel makes student interaction fun and easy.
- » Features a royal blue fabric surface that accepts hook and loop and flannel manipulatives.
- » Dry erase word cards are available separately as another fun interactive learning option.
- » Trimmed in anodized aluminum. Comes with snap-on legs.

● Hook & Loop Tabletop Easel

Part No.	Dimensions	Ship Wt.	Price
724GB*	24"H x 36"W	27 lbs	\$75.21
724GC*	36"H x 48"W	37 lbs	\$130.58

● Dry Erase Word Cards - Small (12 per pkg.)

Part No.	Dimensions	Ship Wt.	Price
548*	2"H x 6"W ea.	1 lb	\$9.41

● Dry Erase Word Cards - Large (6 per pkg.)

Part No.	Dimensions	Ship Wt.	Price
549*	3"H x 12"W ea.	1 lb	\$19.28



Please refer to p. 2 for a description of symbols.

Tabletop Flannel Easel

- » The versatile Tabletop Flannel Easel is ideal for small group tabletop activities
- » Features a black flannel surface, perfect for use with storyboard items
- » Framed in satin anodized aluminum trim. Includes snap-on legs.

● Tabletop Flannel Easel

Part No.	Dimensions	Ship Wt.	Price
721GA*	18"H x 24"W	5 lbs	\$46.54
721GB*	24"H x 36"W	10 lbs	\$58.82
721GU*	30"H x 40"W	15 lbs	\$80.78
721GC*	36"H x 48"W	18 lbs	\$88.96



Please refer to p. 2 for a description of symbols.

Magnetic Language Easels

- » Magnetic Language Easels provide versatility and enjoyment.
- » Double-sided with a magnetic markerboard or chalkboard surface on one side, and hook and loop fabric on the other.
- » Markerboard also available with magnetic flannel on the opposite side. Comes with felt cut-outs and flat magnets (783GA only).
- » Include snap-on legs that make changing the surface easy.

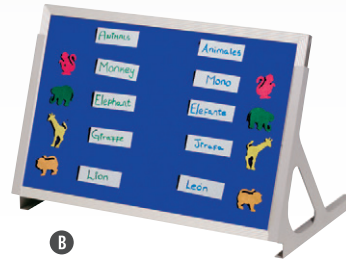
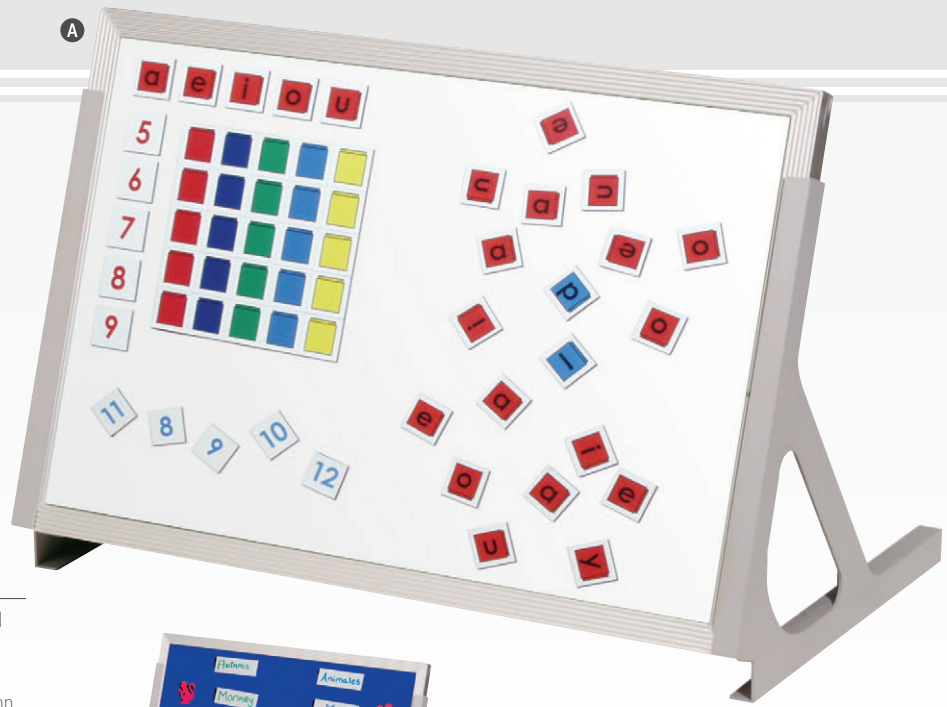

A MLE - Markerboard/Chalkboard

Part No.	Dimensions	Ship Wt.	Price
720G*	12"H x 18"W	6 lbs	\$56.46

B MLE - Markerboard/Hook & Loop

Part No.	Dimensions	Ship Wt.	Price
723GA*	18"H x 24"W	7 lbs	\$84.95
723GB*	24"H x 36"W	11 lbs	\$130.69

C MLE - Markerboard/Flannel

Part No.	Dimensions	Ship Wt.	Price
783GA*	18"H x 24"W	9 lbs	\$92.40



Please refer to p. 2 for a description of symbols.

Lap Board

- » Encourage student interaction with the fun and functional Lap Board.
- » Featuring a magnetic dry erase surface, the board is perfect for spelling, math, or other group activities.
- » Injection-molded plastic frame features round corners for safety.
- » Lap Boards come in sets of 12.

D Lap Board - Set of 12

Part No.	Dimensions	Ship Wt.	Price
630*	9 1/2"H x 11 1/2"W	9 lbs	\$98.35





Administration Products

MooreCo®, Balt® and Best-Rite® have been outfitting the education environment since 1971. But our products don't stop at the classroom threshold. We have a wide variety of products designed to suit the administrative office and internal faculty sections as well. From the teacher's lounge to the principal's office, our products can make your school's offices more ergonomic, efficient and stylish!



Butterfly Chair,
see p. 199.

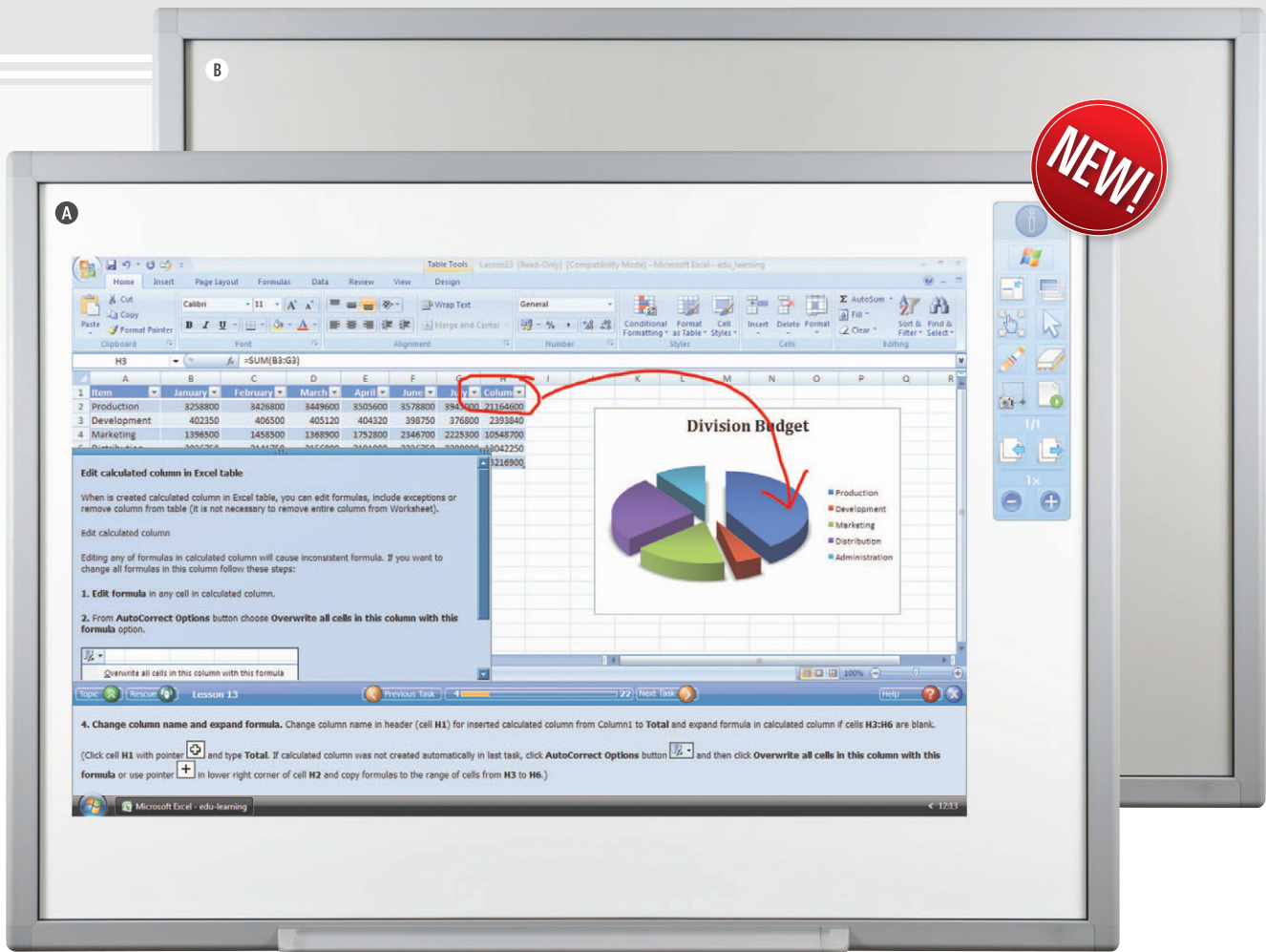

OneBoard™



- » Your OneBoard™ for interactivity, dry erase, projection, and magnetic display that will last a LIFETIME.
- » Combine the utility of a porcelain whiteboard with the power of a computer and projector for a full interactive experience with vivid images, video and audio.
- » Mouse and keyboard emulation allows you to control the computer almost exclusively from the OneBoard™. Software enables the board to act as a human input device (HID). Write, draw, and move objects with just your finger!
- » True multiuser support requires no separate multiuser mode setting to instantly make your lecture more interactive. Supports multiuser writing and common multi-touch gestures currently recognized in Microsoft Windows 7.
- » Open architecture. No requirement to tie yourself to a particular software platform.
- » Optional USB wireless PC adapter available to enable wireless interaction.
- » Porcelain steel can be written on with dry erase, semi-permanent, water-soluble, or permanent markers, pens, or crayons without damaging the surface. Use a dry cloth, eraser, or cleaner to easily remove writing.
- » Also available in matte projection gray surface, cutting glare up to 60%. Gray surface requires a wet cloth to completely clean surface (a small amount of ghosting may occur).
- » RoHS compliant. TAA compliant. GREENGUARD Indoor Air Quality Certified® and GREENGUARD Children & Schools Certified™. Limited lifetime warranty.



Please refer to p. 2 for a description of symbols.



A OneBoard™ - Standard Off White			
Part No.	Dimensions	Ship Wt.	Price
9037G-C	48"H x 67 1/2"W x 1 1/4"D	115 lbs	Call
B OneBoard™ - Projection Gray			
Part No.	Dimensions	Ship Wt.	Price
9057G-C	48"H x 67 1/2"W x 1 1/4"D	00 lbs	Call

NEW!

Magnetic silky smooth glass surface!
Clean edge ultra modern board!
50 Year Guarantee!



Please refer to p. 2 for a description of symbols.



Cleaner & Accessories
pp. 32-33.



Visionary™ Magnetic Glass Dry Erase Board

- » Modernize your space with a functional and contemporary image. Visionary™ magnetic glass boards provide the best of quality and smart style. Borderless and seamless, in glossy white.
- » Surface and coloration are engineered for ideal optical qualities. The glass exhibits good depth of field, good contrast and ambient light toleration.
- » Compatible with any dry/wet-erase marker, grease pen, etc. Easily cleans without ghosting or staining.
- » Simple and sturdy mounting devices are padded to protect surface.
- » 50 year guarantee. GREENGUARD Indoor Air Quality Certified® and GREENGUARD Children & Schools CertifiedSM. Includes magnets, markers, and eraser.

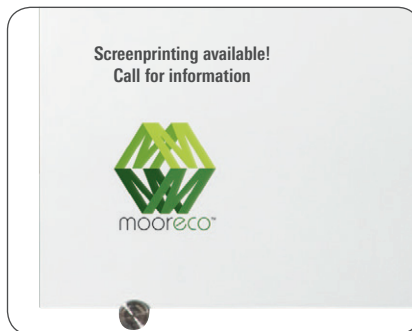
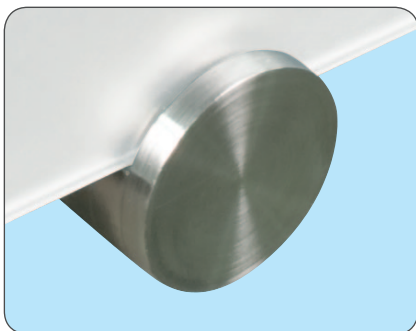

Visionary™ Magnetic Glass Dry Erase Board			
Part No.	Dimensions	Ship Wt.	Price
83843*	2'H x 3'W	22 lbs	\$328.19
83844**	3'H x 4'W	25 lbs	\$353.04
83845	4'H x 6'W	69 lbs	\$768.25
83846	4'H x 8'W	122 lbs	\$919.97



A



- The most vivid and true to life colors of any projection surface available!
- Eliminates dullness from external light sources!
- Doubles as a dry erase markerboard!
- 50 year guarantee!

Revolutionary surface gives vivid images with minimal ambient light distortion!



Please refer to p. 2 for a description of symbols.

Evolution Projection Markerboard with Presidential Trim

- » Evolution porcelain steel markerboard surface is designed with the future in mind, providing an image that is rich and vivid when used with a projector.
- » Low gloss matte gray surface provides exceptional sharpness and clarity, eliminating dullness caused by external light sources.
- » Featured with elegant modern Presidential Trim in either black or silver. Matching Magnetic Q-Tray included.
- » For best results, wet erase gray surface weekly.
- » Rite-On® dry erase markers by Best-Rite® recommended. Pair with one of our marker sets. Accessories sold on page 33.
- » Made in the USA. 50 year guarantee. TAA compliant.



Evolution Projection Markerboard - Presidential Trim				
Silver	Black	Dimensions	Ship Wt.	Price
404PB-52*	404PB-T1-52*	2'H x 3'W	22 lbs	\$195.00
404PC-52**	404PC-T1-52**	3'H x 4'W	25 lbs	\$338.00
404PD-52	404PD-T1-52	4'H x 4'W	69 lbs	\$422.00
404PG-52	404PG-T1-52	4'H x 6'W	122 lbs	\$614.00
404PH-52	404PH-T1-52	4'H x 8'W	145 lbs	\$822.00

■ In Stock: ships within 48 hours of order. ■ Quick Ship: ships within 7 days of order.
 *Ships UPS. **Ships UPS + \$9.00 handling fee.



Cleaner & Accessories pp. 32-33.

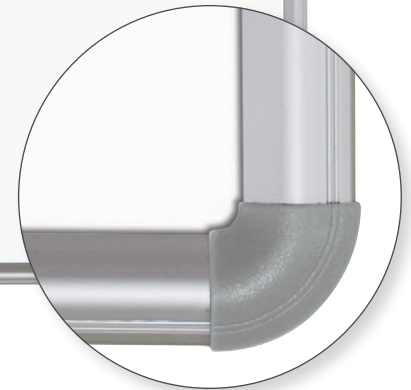

Please refer to p. 2 for a description of symbols.

Green-Rite® Markerboard with Presidential Trim

- » Green-Rite®, an environmentally friendly magnetic porcelain steel dry erase surface, is featured with Presidential Trim.
- » Cradle to Cradle Certified™ - Silver, GREENGUARD Indoor Air Quality Certified® and GREENGUARD Children & Schools Certified™.
- » Board is 84% recyclable, contains over 50% recycled materials, and emits virtually no VOCs.
- » Certified boards incorporate material healthfulness, material reutilization, renewable energy use, water stewardship and social responsibility.
- » Surface provides superior writability, and is virtually indestructible. Magnetic Q-Tray included.
- » Class A Fire Rated board. A full test report copy is available upon request.
- » Made in the USA. 50 year guarantee. TAA compliant.

Green-Rite® Markerboard - Presidential Trim

Silver	Black	Dimensions	Ship Wt.	Price
■ E2H2PB*	■ E2H2PB-T1*	2'H x 3'W	22 lbs	\$208.00
■ E2H2PC**	■ E2H2PC-T1**	3'H x 4'W	25 lbs	\$262.00
■ E2H2PD	■ E2H2PD-T1	4'H x 4'W	69 lbs	\$413.00
■ E2H2PG	■ E2H2PG-T1	4'H x 6'W	122 lbs	\$525.00
■ E2H2PH	■ E2H2PH-T1	4'H x 8'W	145 lbs	\$699.00

Porcelain Steel Markerboard with Ultra Trim

- » Porcelain steel surface is featured with slim Ultra Trim anodized aluminum frame.
- » Cradle to Cradle Certified™ - Silver, GREENGUARD Indoor Air Quality Certified® and GREENGUARD Children & Schools Certified™. Certified boards incorporate material healthfulness, material reutilization, renewable energy use, water stewardship and social responsibility.
- » Virtually indestructible magnetic porcelain steel surface provides superior writability. Magnetic Q-Tray included.
- » Class A Fire Rated board. A full test report copy is available upon request.
- » Made in the USA. 50 year guarantee. TAA compliant.

● Porcelain Steel Markerboard - Ultra Trim

Silver	Black	Dimensions	Ship Wt.	Price
2029B*	2028B*	2'H x 3'W	22 lbs	\$148.00
2029C**	2028C**	3'H x 4'W	25 lbs	\$269.00
2029D	2028D	4'H x 4'W	69 lbs	\$285.63
2029G	2028G	4'H x 6'W	122 lbs	\$499.00
2029H	2028H	4'H x 8'W	145 lbs	\$599.00

Porcelain Steel Markerboard with Origin™ Trim

- » Origin™ Trim is a sophisticated blend of materials, adding richness to any environment.
- » Cradle to Cradle Certified™ - Silver (aluminum trim only). Certified boards incorporate material healthfulness, material reutilization, renewable energy use, water stewardship and social responsibility.
- » Class A Fire Rated board. A full test report copy is available upon request.
- » The magnetic porcelain steel surface is engineered for superior color contrast with markers, and provides smooth writability and easy erasability with no ghosting.
- » Made in the USA. TAA compliant. 50 year guarantee.

● Porcelain Steel Markerboard - Origin™ Trim

Aluminum	Med Oak	Mahogany	Dimensions	Ship Wt.	Price
2020B-01*	2020B-02*	2020B-03*	2'H x 3'W	22 lbs	\$155.00
2020C-01**	2020C-02**	2020C-03**	3'H x 4'W	25 lbs	\$283.00
2020D-01	2020D-02	2020D-03	4'H x 4'W	69 lbs	\$335.00
2020G-01	2020G-02	2020G-03	4'H x 6'W	122 lbs	\$524.00
2020H-01	2020H-02	2020H-03	4'H x 8'W	145 lbs	\$649.00

Porcelain Steel Markerboard with Élan Trim

- » Sophisticated and modern Élan Trim adds elegance to any environment.
- » Mahogany or medium oak finished solid wood with unique angled profile joined with aluminum corner caps.
- » Class A Fire Rated board. A full test report copy is available upon request.
- » Superior porcelain steel dry erase surface. Includes attractive aluminum accessory tray.
- » Made in the USA. TAA compliant. 50 year guarantee.

● Porcelain Steel Markerboard - Élan Trim

Mahogany	Medium Oak	Dimensions	Ship Wt.	Price
2023B*	2023B-OAK*	2'H x 3'W	22 lbs	\$279.00
2023C**	2023C-OAK**	3'H x 4'W	25 lbs	\$579.00
2023D	2023D-OAK	4'H x 4'W	69 lbs	\$618.00
2023G	2023G-OAK	4'H x 6'W	122 lbs	\$695.00
2023H	2023H-OAK	4'H x 8'W	145 lbs	\$799.00





Please refer to p. 2 for a description of symbols.



Dura-Rite® Markerboard with Presidential Trim

- » Dura-Rite® Boards provides a wear-resistant surface at an affordable price
- » HPL provides smooth writability and easy erasability.
- » Elegant Presidential Trim is made from lengths of rounded anodized aluminum joined with matching injection-molded corner pieces.
- » Made in the USA. TAA compliant. 20 year guarantee.

④ Dura-Rite® Markerboard - Presidential Trim

Silver	Black	Dimensions	Ship Wt.	Price
■ 212PB*	■ 212PB-T1*	2'H x 3'W	12 lbs	\$103.03
■ 212PC**	■ 212PC-T1**	3'H x 4'W	22 lbs	\$148.78
■ 212PD	■ 212PD-T1	4'H x 4'W	26 lbs	\$189.28
■ 212PG	■ 212PG-T1	4'H x 6'W	63 lbs	\$288.04
■ 212PH	■ 212PH-T1	4'H x 8'W	78 lbs	\$322.08

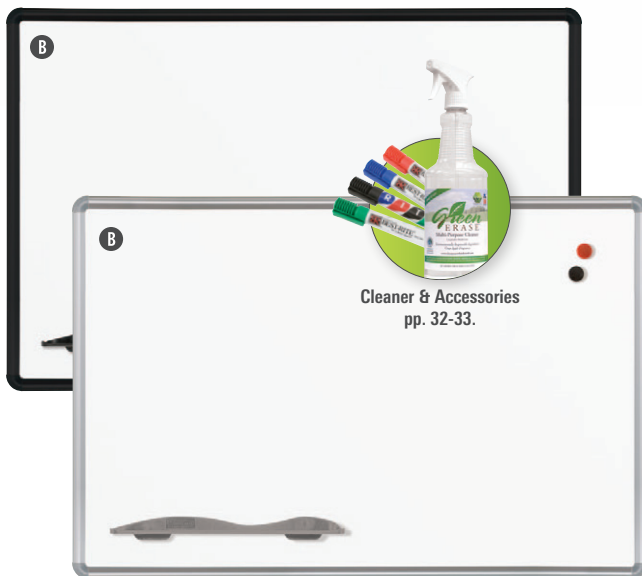

Please refer to p. 2 for a description of symbols.

Magne-Rite Markerboard with Presidential Trim

- » Magne-Rite dry erase markerboard is a specially-engineered magnetic PVC-coated steel that provides exceptionally smooth writability and erases cleanly with no ghosting.
- » Framed in rounded anodized aluminum Presidential Trim in silver or black.
- » 10 year guarantee. TAA compliant. Made in the USA.

⑤ Magne-Rite Markerboard - Presidential Trim

Silver	Black	Dimensions	Ship Wt.	Price
■ 219PB*	■ 219PB-T1*	2'H x 3'W	12 lbs	\$117.92
■ 219PC**	■ 219PC-T1**	3'H x 4'W	22 lbs	\$220.97
■ 219PD	■ 219PD-T1	4'H x 4'W	26 lbs	\$239.68
■ 219PG	■ 219PG-T1	4'H x 6'W	63 lbs	\$389.27
■ 219PH	■ 219PH-T1	4'H x 8'W	78 lbs	\$501.47

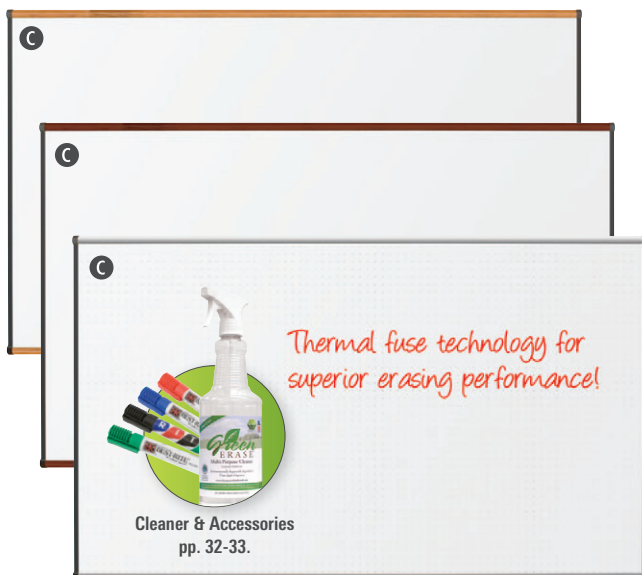

Please refer to p. 2 for a description of symbols.



TuF-Rite™ Markerboard with Origin™ Trim

- » New TuF-Rite™ surface provides a vast improvement over standard economy melamine boards. Thermal fuse technology improves erasability and lasts up to three times as long.
- » Available with a pale gray dot pattern for easier writing and drawing. Call for info.
- » Featured with Origin™ Trim, a sophisticated blend of materials to match any decor. Available in anodized aluminum, oak, or mahogany.
- » 5 year guarantee.

⑥ TuF-Rite™ Markerboard - Origin™ Trim

Aluminum	Med Oak	Mahogany	Dimensions	Ship Wt.	Price
2210B-01*	2210B-02*	2210B-03*	2'H x 3'W	12 lbs	\$62.25
2210C-01**	2210C-02**	2210C-03**	3'H x 4'W	22 lbs	\$69.56
2210D-01	2210D-02	2210D-03	4'H x 4'W	35 lbs	\$115.16
2210G-01	2210G-02	2210G-03	4'H x 6'W	62 lbs	\$261.56
2210H-01	2210H-02	2210H-03	4'H x 8'W	77 lbs	\$311.96



Please refer to p. 2 for a description of symbols.

Hang Up Board

- » The Hang-Up board has unique and stylish anodized aluminum trim. Compact size makes it ideal for most work areas. Mounts to a wall or hangs over a door or cubicle wall with optional hanging brackets.
- » Dry erase surface doubles as a magnetic bulletin board.
- » Aluminum trim includes a slat panel designed to hold optional accessory tray set.
- » Made in the USA. TAA compliant.

A Hang Up Board

Part No.	Dimensions	Ship Wt.	Price
661AA**	1 ½H x 2'W	48 lbs	\$100.46
661AB**	2'H x 3'W	55 lbs	\$130.37

B Cubicle Hanging Brackets

Part No.	Ship Wt.	Price
830HB*	5 lbs	\$33.11

C Accessory Tray Set

Part No.	Description	Ship Wt.	Price
661PT*	Set of 3 assorted size trays	5 lbs	\$28.74

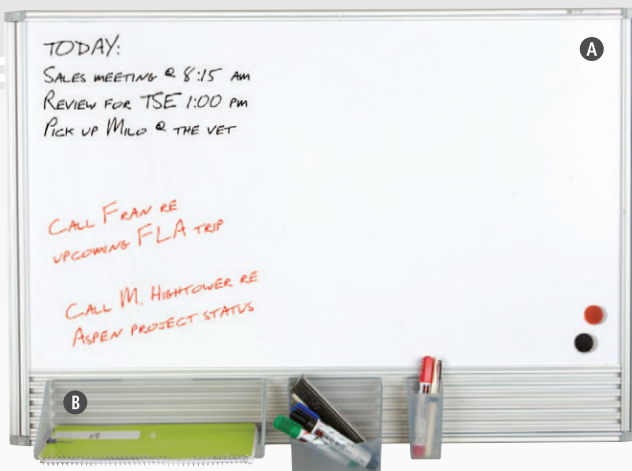

Notebook

- » The Notebook design increases writing area by up to 300% over a standard board.
- » Available with either one or two interior panels. Front panel is vinyl-covered tackboard. Back panel is porcelain steel dry erase board. Interior panels are double-sided Dura-Rite® high pressure laminate dry erase surface.
- » Adjustable brackets to hang over a door or cubicle wall are available separately.
- » Made in the USA. TAA compliant.

D Notebook - Single Interior Panel

Part No.	Dimensions	Ship Wt.	Price
830AA-PV-SINGLE*	2'H x 1 ½'W	18 lbs	\$213.02
830AB-PV-SINGLE**	3'H x 2'W	35 lbs	\$301.32

E Notebook - Double Interior Panel

Part No.	Dimensions	Ship Wt.	Price
830AA**	2'H x 1 ½'W	24 lbs	\$316.62
830AB**	3'H x 2'W	43 lbs	\$501.14

F Cubicle Hanging Brackets

Part No.	Ship Wt.	Price
830HB*	5 lbs	\$33.11



Please refer to p. 2 for a description of symbols.



Message Board

- » The magnetic Message Board's compact size makes it ideal for smaller work areas. Ideal for hanging outside a doorway. Hangs either horizontally or vertically.
- » Made in the USA. TAA compliant.

G Message Board

Part No.	Dimensions	Ship Wt.	Price
633*	24" x 8 ½"	5 lbs	\$27.32



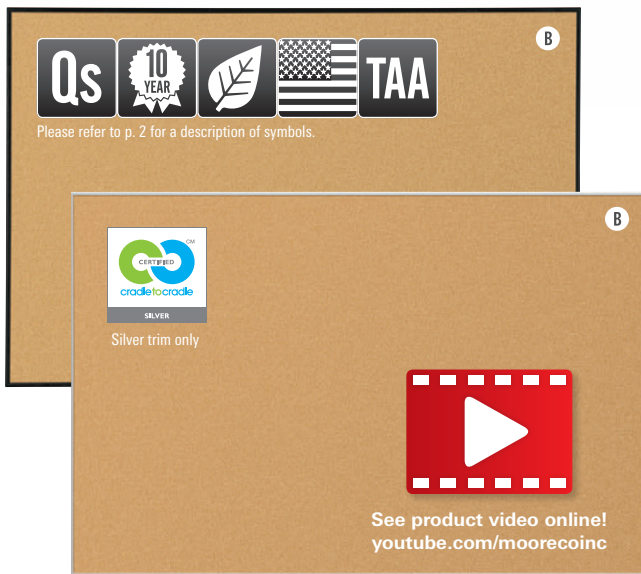

VT Logic Tackboard with Presidential Trim

- » Eco-friendly VT Logic natural cork surface is featured with anodized aluminum Presidential Trim. Available in silver or black.
- » Cradle to Cradle Certified™ - Silver. Certified boards incorporate material healthfulness, material reutilization, renewable energy use, water stewardship and social responsibility.
- » Completely recyclable surface is bonded to insulation board for superb tack-holding ability. Surface is durable and self-healing.
- » Made in the USA. TAA compliant. 10 year guarantee.

VT Logic Tackboard - Presidential Trim

Silver	Black	Dimensions	Ship Wt.	Price
E301PB*	E301PB-T1*	2'H x 3'W	9 lbs	\$74.00
E301PC**	E301PC-T1**	3'H x 4'W	19 lbs	\$122.00
E301PD	E301PD-T1	4'H x 4'W	20 lbs	\$157.00
E301PG	E301PG-T1	4'H x 6'W	30 lbs	\$215.00
E301PH	E301PH-T1	4'H x 8'W	43 lbs	\$271.00

VT Logic Tackboard with Presidential Trim

- » Eco-friendly VT Logic natural cork surface is featured with anodized aluminum Presidential Trim. Available in silver or black.
- » Cradle to Cradle Certified™ - Silver. Certified boards incorporate material healthfulness, material reutilization, renewable energy use, water stewardship and social responsibility.
- » Completely recyclable surface is bonded to insulation board for superb tack-holding ability. Surface is durable and self-healing.
- » Made in the USA. TAA compliant. 10 year guarantee.

VT Logic Tackboard - Ultra Trim

Silver	Black	Dimensions	Ship Wt.	Price
E3019B*	E3018B*	2'H x 3'W	9 lbs	\$57.00
E3019C**	E3018C**	3'H x 4'W	19 lbs	\$97.00
E3019D	E3018D	4'H x 4'W	20 lbs	\$113.50
E3019G	E3018G	4'H x 6'W	30 lbs	\$157.00
E3019H	E3018H	4'H x 8'W	43 lbs	\$206.00

VT Logic Tackboard with Origin™ Trim

- » New Origin™ Trim is a sophisticated blend of materials, adding richness to any environment. Available in silver anodized aluminum.
- » Cradle to Cradle Certified™ - Silver. Certified boards incorporate material healthfulness, material reutilization, renewable energy use, water stewardship and social responsibility.
- » Naturally renewable VT Logic cork surface is durable, self-healing, and environmentally responsible.
- » Made in the USA. TAA compliant. 10 year guarantee.

VT Logic Tackboard - Origin™ Trim

Part No.	Dimensions	Ship Wt.	Price
E3010B-01*	2'H x 3'W	9 lbs	\$103.00
E3010C-01**	3'H x 4'W	19 lbs	\$156.00
E3010D-01	4'H x 4'W	20 lbs	\$194.00
E3010G-01	4'H x 6'W	30 lbs	\$261.00
E3010H-01	4'H x 8'W	43 lbs	\$345.00



Please refer to p. 2 for a description of symbols.



Natural Add-Cork Tackboard with Presidential Trim

- » Natural Add-Cork boards feature 1/8" cork over a thicker and more durable substrate. Featured with elegant Presidential Trim in silver or black.
- » Naturally renewable cork is durable, self-healing, and environmentally responsible.
- » Made in the USA. TAA compliant. 10 year guarantee. GREENGUARD Indoor Air Quality Certified® and GREENGUARD Children & Schools CertifiedSM.

④ Natural Add-Cork Tackboard - Presidential Trim

Silver	Black	Dimensions	Ship Wt.	Price
302PB*	302PB-T1*	2'H x 3'W	12 lbs	\$74.21
302PC**	302PC-T1**	3'H x 4'W	24 lbs	\$131.58
302PD	302PD-T1	4'H x 4'W	32 lbs	\$149.88
302PG	302PG-T1	4'H x 6'W	48 lbs	\$233.81
302PH	302PH-T1	4'H x 8'W	64 lbs	\$306.30

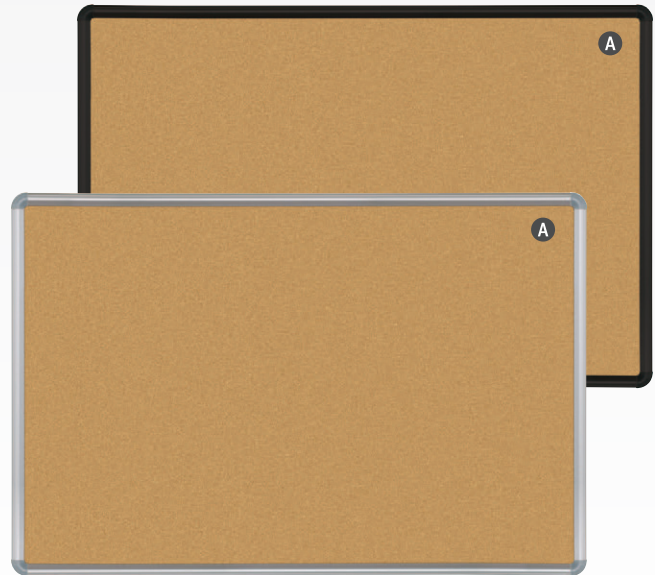

Natural Cork-Plate Tackboard with Origin™ Trim

- » Origin™ Trim is a sophisticated blend of materials, adding richness to any environment. Available in silver anodized aluminum, and in medium oak or mahogany solid wood.
- » Cork-Plate surface features 1/4" natural cork bonded to a 1/4" moisture-resistant substrate for superior durability.
- » Made in the USA. TAA compliant. 10 year guarantee.

⑤ Natural Cork-Plate Tackboard - Origin™ Trim

Aluminum	Med Oak	Mahogany	Dimensions	Ship Wt.	Price
3030B-01*	3030B-02*	3030B-03*	2'H x 3'W	17 lbs	\$92.00
3030C-01**	3030C-02**	3030C-03**	3'H x 4'W	33 lbs	\$150.00
3030D-01	3030D-02	3030D-03	4'H x 4'W	44 lbs	\$212.00
3030G-01	3030G-02	3030G-03	4'H x 6'W	66 lbs	\$315.00
3030H-01	3030H-02	3030H-03	4'H x 8'W	88 lbs	\$401.00

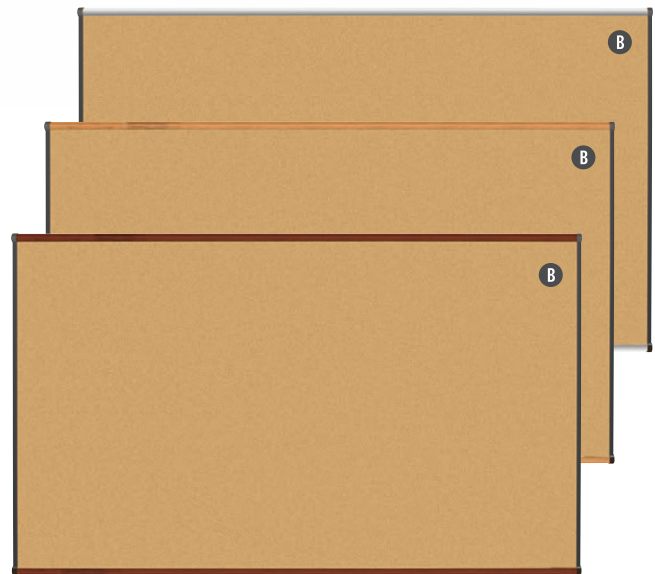

Natural Cork-Plate Tackboard with Élan Trim

- » Sophisticated and modern Élan Trim adds elegance to any environment.
- » Mahogany or medium oak finished solid wood with unique angled profile joined with aluminum corner caps.
- » Surface is 1/4" thick cork surface laminated to 1/4" thick durable and moisture-resistant substrate for superior quality.
- » Made in the USA. TAA compliant. 10 year guarantee.

④ Natural Add-Cork Tackboard - Élan Trim

Mahogany	Medium Oak	Dimensions	Ship Wt.	Price
3033B*	3033B-OAK*	2'H x 3'W	17 lbs	\$139.00
3033C**	3033C-OAK**	3'H x 4'W	33 lbs	\$239.00
3033D	3033D-OAK	4'H x 4'W	44 lbs	\$315.00
3033G	3033G-OAK	4'H x 6'W	66 lbs	\$429.00
3033H	3033H-OAK	4'H x 8'W	88 lbs	\$575.00





Please refer to p. 2 for a description of symbols.

Black Splash-Cork Tackboard with Black Presidential Trim

- » Eco-friendly Black Splash-Cork surface is featured with black Presidential Trim.
- » Completely recyclable cork surface. Cradle to Cradle Certified^{CM} - Silver, GREENGUARD Indoor Air Quality Certified[®] and GREENGUARD Children & Schools CertifiedSM.
- » Certified boards incorporate material healthfulness, material reutilization, renewable energy use, water stewardship and social responsibility.
- » Naturally renewable cork is mixed with a tinted binder for a surface that is durable, self-healing, and environmentally responsible.
- » Made in the USA. 10 year guarantee. GSA/TAA compliant.

Black Splash-Cork Tackboard - Black Presidential Trim

Part No.	Dimensions	Ship Wt.	Price
E300PB-T1*	2'H x 3'W	12 lbs	\$89.00
E300PC-T1**	3'H x 4'W	24 lbs	\$153.00
E300PD-T1	4'H x 4'W	32 lbs	\$206.36
E300PG-T1	4'H x 6'W	48 lbs	\$287.00
E300PH-T1	4'H x 8'W	64 lbs	\$359.00

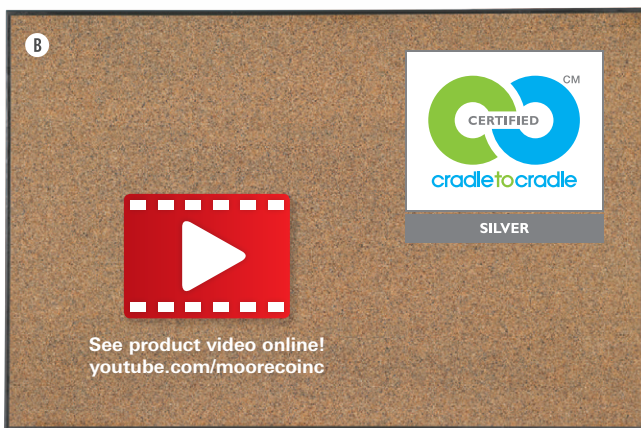

Please refer to p. 2 for a description of symbols.

Black Splash-Cork Tackboard with Black Ultra Trim

- » Eco-friendly Black Splash-Cork surface is featured with black Ultra Trim.
- » Completely recyclable cork surface. Cradle to Cradle Certified^{CM} - Silver, GREENGUARD Indoor Air Quality Certified[®] and GREENGUARD Children & Schools CertifiedSM.
- » Certified boards incorporate material healthfulness, material reutilization, renewable energy use, water stewardship and social responsibility.
- » Naturally renewable cork is mixed with a tinted binder for a surface that is durable, self-healing, and environmentally responsible.
- » Made in the USA. 10 year guarantee. GSA/TAA compliant.

Black Splash-Cork Tackboard - Black Ultra Trim

Part No.	Dimensions	Ship Wt.	Price
E3008B*	2'H x 3'W	12 lbs	\$61.00
E3008C**	3'H x 4'W	24 lbs	\$106.00
E3008D	4'H x 4'W	32 lbs	\$137.00
E3008G	4'H x 6'W	48 lbs	\$198.00
E3008H	4'H x 8'W	64 lbs	\$259.00



Please refer to p. 2 for a description of symbols.

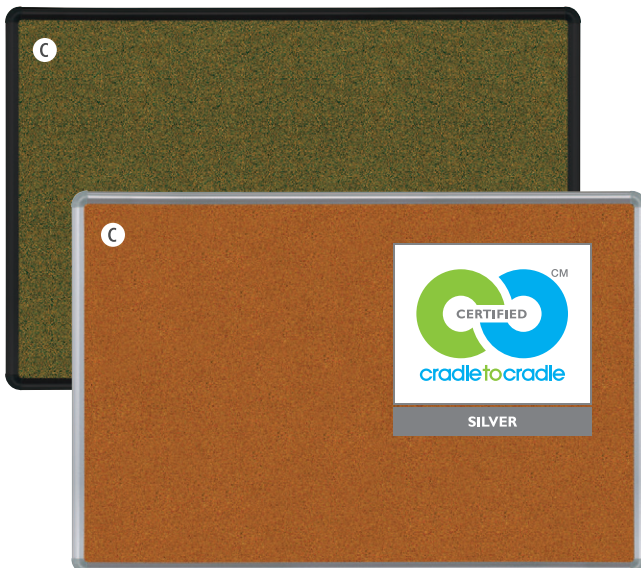

Splash-Cork Tackboard with Presidential Trim

- » Splash-Cork boards provide a subtle splash of color to any environment. Natural cork is bonded with a tinted binder for flexible, durable and self-healing boards.
- » Cradle to Cradle Certified^{CM} - Silver (silver trim only), GREENGUARD Indoor Air Quality Certified[®] and GREENGUARD Children & Schools CertifiedSM.
- » Made in the USA. TAA compliant. 10 year guarantee. Please specify color.

Splash-Cork Tackboard - Presidential Trim

Silver	Black	Dimensions	Ship Wt.	Price
300PB-XX*	300PB-T1-XX*	2'H x 3'W	12 lbs	\$94.37
300PC-XX**	300PC-T1-XX**	3'H x 4'W	24 lbs	\$161.37
300PD-XX	300PD-T1-XX	4'H x 4'W	32 lbs	\$206.36
300PG-XX	300PG-T1-XX	4'H x 6'W	48 lbs	\$285.71
300PH-XX	300PH-T1-XX	4'H x 8'W	64 lbs	\$345.52



Please refer to p. 2 for a description of symbols.

Vin-Tak Tackboard with Presidential Trim



- » Fabric-backed vinyl over lightweight substrate for an economical and attractive tackboard. Featured with elegant Presidential Trim in silver or black.
- » Easy to clean. Treated to resist the growth of odor- and stain-causing microbes.
- » Made in the USA. TAA compliant. 10 year guarantee. GREENGUARD Indoor Air Quality Certified® and GREENGUARD Children & Schools CertifiedSM.
- » See all vinyl color options on page 220.

Vin-Tak Tackboard - Presidential Trim				
Silver	Black	Dimensions	Ship Wt.	Price
311PB*	311PB-T1*	2'H x 3'W	7 lbs	\$62.13
311PC**	311PC-T1**	3'H x 4'W	14 lbs	\$105.16
311PD	311PD-T1	4'H x 4'W	20 lbs	\$140.00
311PG	311PG-T1	4'H x 6'W	37 lbs	\$192.00
311PH	311PH-T1	4'H x 8'W	49 lbs	\$250.00



Pebbles Vinyl Tackboard with Presidential Trim



- » Pebbles Vinyl is fabric-backed and textured to hide pin holes. Framed in modern Presidential Trim in silver or black.
- » Vinyl is treated to resist the growth of odor- and stain-causing microbes.
- » Made in the USA. TAA compliant. 10 year guarantee.
- » GREENGUARD Indoor Air Quality Certified® and GREENGUARD Children & Schools CertifiedSM.
- » See all vinyl color options on page 220.

Pebbles Vinyl Tackboard - Presidential Trim				
Silver	Black	Dimensions	Ship Wt.	Price
311PB-PV*	311PB-T1-PV*	2'H x 3'W	7 lbs	\$62.90
311PC-PV**	311PC-T1-PV**	3'H x 4'W	14 lbs	\$107.70
311PD-PV	311PD-T1-PV	4'H x 4'W	20 lbs	\$145.00
311PG-PV	311PG-T1-PV	4'H x 6'W	37 lbs	\$194.23
311PH-PV	311PH-T1-PV	4'H x 8'W	49 lbs	\$255.70

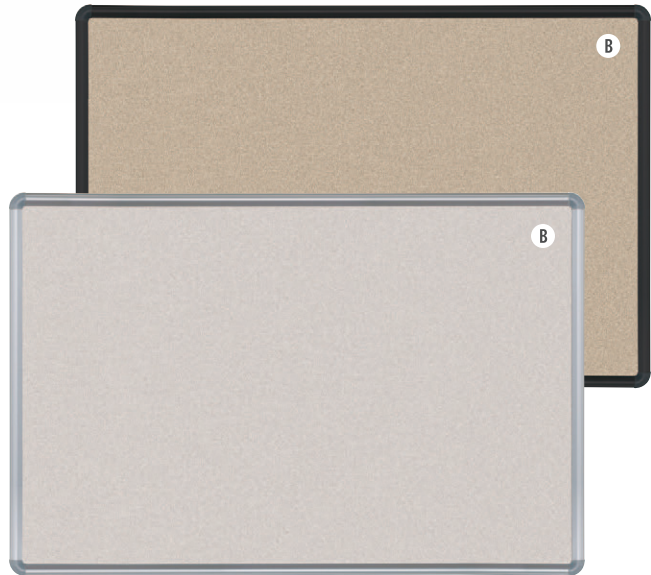

Please refer to p. 2 for a description of symbols.

Fab-Tak Tackboard with Presidential Trim

- » Fab-Tak Boards feature Polyolefin fabric with a lightweight tackable substrate. Featured with modern and curved Presidential Trim.
- » Fabric is washable and unaffected by most common chemicals, salts, and cleansers. Treated to resist the growth of stain- and odor-causing microbes.
- » Made in the USA. TAA compliant. 10 year guarantee.

Fab-Tak Tackboard - Presidential Trim				
Silver	Black	Dimensions	Ship Wt.	Price
331PB*	331PB-T1*	2'H x 3'W	7 lbs	\$76.00
331PC**	331PC-T1**	3'H x 4'W	14 lbs	\$132.00
331PD	331PD-T1	4'H x 4'W	20 lbs	\$161.00
331PG	331PG-T1	4'H x 6'W	37 lbs	\$251.00
331PH	331PH-T1	4'H x 8'W	49 lbs	\$326.00



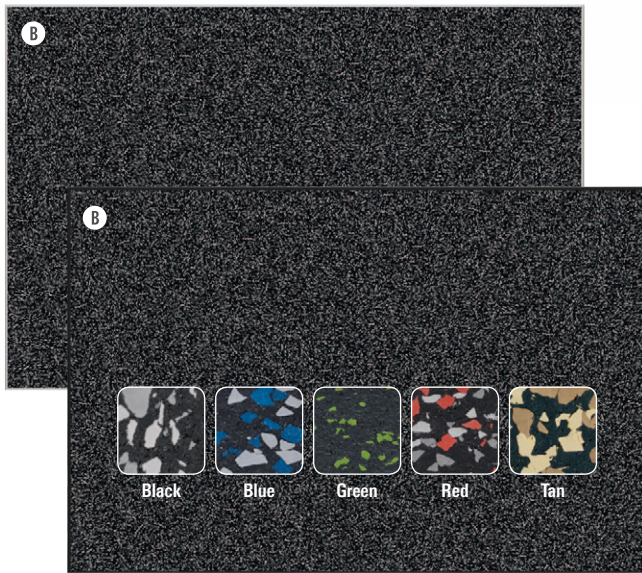

Please refer to p. 2 for a description of symbols.

Rubber-Tak Tackboard with Presidential Trim

- » Rubber-Tak tackboards are made with recycled rubber, providing superior resilience. Framed in Presidential Trim in silver or black.
- » Surface resists most chemicals, stain- and odor-causing microbes, is easy to clean, and is sound- and shock-absorbent.
- » Made in the USA. TAA compliant. 50 year guarantee. GREENGUARD Indoor Air Quality Certified® and GREENGUARD Children & Schools CertifiedSM.

● Rubber-Tak Tackboard - Presidential Trim

Silver	Black	Dimensions	Ship Wt.	Price
■ 321PB*	■ 321PB-T1*	2'H x 3'W	17 lbs	\$84.00
■ 321PC**	■ 321PC-T1**	3'H x 4'W	33 lbs	\$126.00
■ 321PD	■ 321PD-T1	4'H x 4'W	44 lbs	\$168.00
■ 321PG	■ 321PG-T1	4'H x 6'W	66 lbs	\$237.00
■ 321PH	■ 321PH-T1	4'H x 8'W	88 lbs	\$283.00

Rubber-Tak Tackboard with Ultra Trim

- » Rubber-Tak tackboards are made with recycled rubber, providing superior resilience. Framed in slim Ultra Trim in silver or black.
- » Surface resists most chemicals, stain- and odor-causing microbes, is easy to clean, and is sound- and shock-absorbent.
- » Made in the USA. TAA compliant. 50 year guarantee. GREENGUARD Indoor Air Quality Certified® and GREENGUARD Children & Schools CertifiedSM.

● Rubber-Tak Tackboard - Ultra Trim

Silver	Black	Dimensions	Ship Wt.	Price
■ 3219B*	■ 3218B*	2'H x 3'W	17 lbs	\$72.00
■ 3219C**	■ 3218C**	3'H x 4'W	33 lbs	\$112.00
■ 3219D	■ 3218D	4'H x 4'W	44 lbs	\$150.00
■ 3219G	■ 3218G	4'H x 6'W	66 lbs	\$210.00
■ 3219H	■ 3218H	4'H x 8'W	88 lbs	\$249.00



Please refer to p. 2 for a description of symbols.

ReTire Tackboard with Ultra Trim

- » ReTire Board features a rubber surface that is 100% recycled. The rubber content is 90% post consumer and 10% post-industrial.
- » Multi-colored, textured surface has unmatched durability and resists moisture, chemicals, stains, and fading.
- » Made in the USA. TAA compliant. 20 year guarantee.

● ReTire Tackboard - Ultra Trim

Silver	Black	Dimensions	Ship Wt.	Price
■ 3209B*	■ 3208B*	2'H x 3'W	17 lbs	\$57.00
■ 3209C**	■ 3208C**	3'H x 4'W	33 lbs	\$93.00
■ 3209D	■ 3208D	4'H x 4'W	44 lbs	\$124.00
■ 3209G	■ 3208G	4'H x 6'W	66 lbs	\$168.00
■ 3209H	■ 3208H	4'H x 8'W	88 lbs	\$218.00

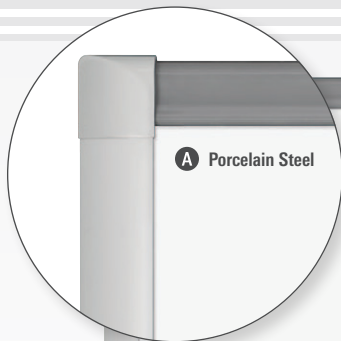

NEW!



Choose from
a variety of
surfaces!

Coordinates
seamlessly with
your interactive
board!

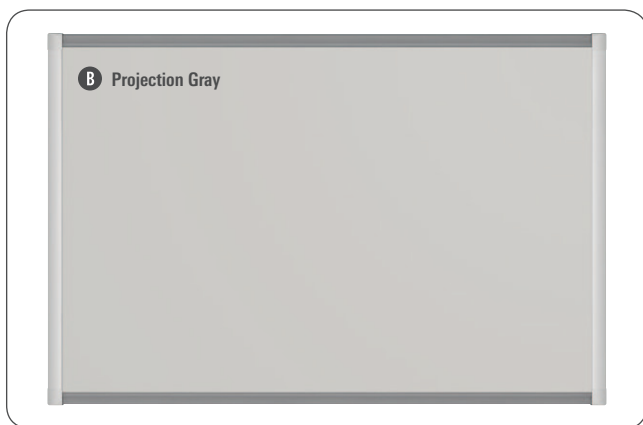

Please refer to p. 2 for a description of symbols.

Smartest Companion

- » Elegant and contemporary Smartest Companion coordinates seamlessly in any environment. Designed to integrate with other major touchboard brands.
- » Adds flawless style and a finished appearance to your classroom, boardroom, or conference room. Made with anodized aluminum, the durable trim features contrasting light and dark gray joined with smoothly sculpted corner pieces.
- » Available with a variety of surface options including porcelain steel, projection gray porcelain steel, natural cork, and more. TAA compliant.

The Smartest Companion is custom-made to your size specifications! Choose from Porcelain Steel, Projection Gray, or Natural Cork surfaces. Call for pricing.



Smooth matte gray trim coordinates seamlessly with the OneBoard™ Interactive Whiteboard! See p. 177.



Trim coordinates seamlessly with OneBoard!

Durable and magnetic porcelain steel surface!

Or choose from a variety of surfaces to meet your needs!



Cleaner & Accessories pp. 32-33.



Please refer to p. 2 for a description of symbols.

OneBoard™ Companion

- » Designed to match the trim of the OneBoard™ Interactive Whiteboard, the OneBoard™ Companion coordinates seamlessly in any environment.
- » Adds flawless style and a finished appearance to your classroom, boardroom, or conference room. Made with anodized aluminum, the durable trim features a matte gray finish and rounded corner pieces.
- » Available with a variety of surface options including porcelain steel markerboard, projection gray porcelain steel, natural cork, and more. TAA compliant.

The OneBoard™ Companion is custom-made to your size specifications! Choose from Porcelain Steel, Projection Gray, or Natural Cork surfaces. Call for pricing.



Please refer to p. 2 for a description of symbols.

Deluxe Conference Room Cabinet

- » The handsome Deluxe Conference Room Cabinet is available with an oak or mahogany finish.
- » Magnetic porcelain steel dry erase markerboard surface.
- » Door interiors feature natural cork tackboard and full-length piano hinges.

Part No.	Dimensions	Ship Wt.	Price
A Deluxe Conference Room Cabinet - Oak			
8420	4'H x 4'W x 5"D	116 lbs	\$1,240.05
B Deluxe Conference Room Cabinet - Mahogany			
842C	4'H x 4'W x 5"D	116 lbs	\$1,240.05



Also available in oak finish.



Cleaner & Accessories pp. 32-33.



Please refer to p. 2 for a description of symbols.

Executive Conference Room Cabinet

- » The Executive Conference features a magnetic markerboard surface.
- » Doors are connected with pinch-proof piano hinges and feature a natural cork surface.
- » Constructed of beautiful oak veneer, the cabinet is available with a mahogany finish.

Part No.	Dimensions	Ship Wt.	Price
C Executive Conference Room Cabinet			
841C	3'H x 3'W x 3 1/2"D	46 lbs	\$570.96



Cleaner & Accessories pp. 32-33.



Please refer to p. 2 for a description of symbols.

Tambour Door Enclosed Cabinet

- » The Tambour Door Enclosed Cabinet features unique tambour doors that slide behind the dry erase markerboard surface when in use, saving valuable wall space.
- » The doors lock when closed, ensuring information security and privacy.
- » The magnetic dry erase markerboard surface provides smooth writability and easy erasability.
- » Cabinet available in an oak or mahogany finish

Part No.	Dimensions	Ship Wt.	Price
D Tambour Door Enclosed Cabinet - Oak			
8430	32"H x 44"W x 4"D	60 lbs	\$579.22
E Tambour Door Enclosed Cabinet - Mahogany			
843C	32"H x 44"W x 4"D	60 lbs	\$579.22

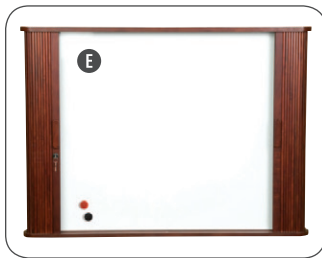



Custom colors available!
See pages 10-11.



Please refer to p. 2 for a description of symbols.

Height Adjustable Flipper Tables

- » Easily accommodate a range of ages and sizes with the Height Adjustable Flipper Table, the most flexible table on the market.
- » Tables adjust from 24 1/4" to 32 3/4" and flip back with a simple one handed lever mechanism to allow for easy nesting and storage.
- » Each features a 1" thick HPL top available in six quick ship colors (please specify when ordering), or can be customized with any Wilsonart® HPL and edge band. Visit www.moorecoinc.com/custom for more information.
- » Powder-coated steel frame with stabilizing stretcher bar and 3" locking casters.
- » TAA compliant. Tested to support up to 300 lbs.

The most versatile table on the market today!

Height Adjustable Flipper Table - 6024	Part No.	Dimensions	Ship Wt.	Price
	90179-XXXX-XX	24 1/4" - 32 3/4"H x 60"W x 24"D	90 lbs	\$438.00
Height Adjustable Flipper Table - 7224	Part No.	Dimensions	Ship Wt.	Price
	90180-XXXX-XX	24 1/4" - 32 3/4"H x 72"W x 24"D	123 lbs	\$490.00
Height Adjustable Flipper Table - Half Round	Part No.	Dimensions	Ship Wt.	Price
	90178-XXXX-XX	24 1/4" - 32 3/4"H x 48"W x 24"D	61 lbs	\$379.00



Please refer to p. 2 for a description of symbols.

Flipper Tables

- » Easily create a multipurpose work area with versatile Flipper Tables.
- » Tops are vacuum-formed PVC available with a teak or mahogany wood grain finish.
- » Flip top back with a simple lever mechanism and nest together space-saving storage.
- » Frame is black powder-coated steel and includes a perforated steel modesty panel.
- » Each table rolls easily out of the way on 2" casters (two locking).
- » TAA compliant. 10 year guarantee. Tested to support up to 300 lbs. GREENGUARD Indoor Air Quality Certified® and GREENGUARD Children & Schools Certified™.

Flipper 3624 Table

Part No.	Color	Dimensions	Ship Wt.	Price
89870*	Teak	29 1/2"H x 36"W x 24"D	56 lbs	\$369.63
89876*	Mahogany	29 1/2"H x 36"W x 24"D	56 lbs	\$369.63

Flipper 6024 Table

Part No.	Color	Dimensions	Ship Wt.	Price
89775	Teak	29 1/2"H x 60"W x 24"D	86 lbs	\$597.70
89879	Mahogany	29 1/2"H x 60"W x 24"D	86 lbs	\$597.70

Flipper 7224 Table

Part No.	Color	Dimensions	Ship Wt.	Price
89863	Teak	29 1/2"H x 72"W x 24"D	118 lbs	\$633.65
89880	Mahogany	29 1/2"H x 72"W x 24"D	118 lbs	\$633.65

Flipper Half Round

Part No.	Color	Dimensions	Ship Wt.	Price
89773*	Teak	29 1/2"H x 48"W x 24"D	58 lbs	\$448.28
89877*	Mahogany	29 1/2"H x 48"W x 24"D	58 lbs	\$448.28



Please refer to p. 2 for a description of symbols.

Chi Flipper Tables

- » Elegant Chi Flipper Tables make an ideal addition to any training or conference room.
- » GREENGUARD Indoor Air Quality Certified® and GREENGUARD Children & Schools Certified™.
- » Tops are vacuum-formed PVC with either a cherry woodgrain or gray nebula finish.
- » Tops flip back with a simple lever mechanism. Frame is black powder-coated steel with a full length stretcher bar and a privacy panel. Roll easily out of the way on 2" casters (two locking).
- » TAA compliant. Tested to support up to 300 lbs.

Chi Flipper Table - 6024

Part No.	Color	H x W x D	Ship Wt.	Price
90099	CH	29 1/2" x 60" x 24"	86 lbs	\$344.84
90102	GN	29 1/2" x 60" x 24"	86 lbs	\$344.84

Chi Flipper Table - 7224

Part No.	Color	H x W x D	Ship Wt.	Price
90100	CH	29 1/2" x 72" x 24"	118 lbs	\$394.57
90103	GN	29 1/2" x 72" x 24"	118 lbs	\$394.57

Chi Flipper Table - Half Round

Part No.	Color	H x W x D	Ship Wt.	Price
90098	CH	29 1/2" x 48" x 24"	58 lbs	\$277.05
90101	GN	29 1/2" x 48" x 24"	58 lbs	\$277.05



Please refer to p. 2 for a description of symbols.

Economy Flipper Tables

- » Use versatile and economical Economy Flipper Tables for your training or conference room.
- » GREENGUARD Indoor Air Quality Certified® and GREENGUARD Children & Schools Certified™.
- » Tops are vacuum-formed PVC with either a teak or mahogany wood grain finish. Tops flip back with a simple lever mechanism and nest together for space-saving storage.
- » Frame is black powder-coated steel with 2" casters (two locking).
- » TAA compliant. Tested to support up to 300 lbs.

Economy Flipper Table - 6024

Part No.	Color	H x W x D	Ship Wt.	Price
90093	Teak	29 1/2" x 60" x 24"	86 lbs	\$300.02
90096	Mahog	29 1/2" x 60" x 24"	86 lbs	\$300.02

Economy Flipper Table - 7224

Part No.	Color	H x W x D	Ship Wt.	Price
90094	Teak	29 1/2" x 60" x 24"	118 lbs	\$328.56
90097	Mahog	29 1/2" x 60" x 24"	118 lbs	\$328.56

Economy Flipper Table - Half Round

Part No.	Color	H x W x D	Ship Wt.	Price
90092	Teak	29 1/2" x 60" x 24"	58 lbs	\$234.62
90095	Mahog	29 1/2" x 60" x 24"	58 lbs	\$234.62





Custom colors available!
See pages 10-11.



See product video online!
youtube.com/moorecoinc



Please refer to p. 2 for a description of symbols.

Lumina™ Tables

- » Create a designer training or conference room with the elegant line of Lumina™ Tables. In stock in antimicrobial gray/platinum and in black cherry. Custom top options available Call for details or visit www.moorecoinc.com/custom
- » The antimicrobial technology is an integral part of the powder coat formula on the gray table tops, and inhibits the growth of mold, mildew, and fungus.
- » The 1" thick tops flip back with an easy-operation lever mechanism and roll easily out of the way on 3" casters (2 locking).
- » Powder-coated steel frame includes a stabilizing stretcher bar. Optional modesty panel available. Tested to support up to 300 lbs.
- » Limited lifetime warranty on antimicrobial gray only. GREENGUARD Indoor Air Quality Certified® and GREENGUARD Children & Schools CertifiedSM.

Lumina™ 6024 Table				
Part No.	Color	Dimensions	Ship Wt.	Price
89954	Platinum/Gray	29 1/2"H x 60"W x 24"D	81 lbs	\$576.45
90064	Black/Cherry	29 1/2"H x 60"W x 24"D	81 lbs	\$502.95
Lumina™ 7224 Table				
Part No.	Color	Dimensions	Ship Wt.	Price
89955	Platinum/Gray	29 1/2"H x 72"W x 24"D	113 lbs	\$628.95
90067	Black/Cherry	29 1/2"H x 72"W x 24"D	113 lbs	\$565.95
Lumina™ Half Round Table				
Part No.	Color	Dimensions	Ship Wt.	Price
89956	Platinum/Gray	29 1/2"H x 48"W x 24"D	53 lbs	\$423.15
89999	Black/Cherry	29 1/2"H x 48"W x 24"D	53 lbs	\$397.95
Lumina™ Modesty Panel				
Part No.	Color	Ship Wt.	Price	
66613	Platinum	10"H x 45"W x 3"D	11 lbs	\$99.99
66612	Black	10"H x 45"W x 3"D	11 lbs	\$99.99

■ In Stock: ships within 48 hours of order. ■ Quick Ship: ships within 7 days of order.
*Ships UPS. **Ships UPS + \$9.00 handling fee.

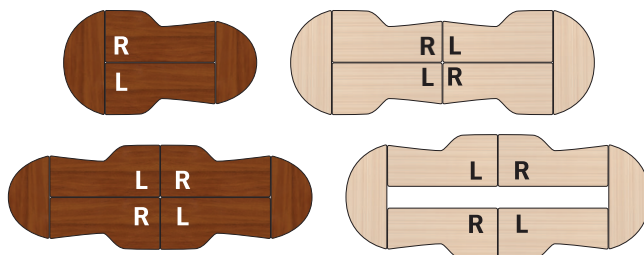

New in Cherry with black legs!



See product video online!
youtube.com/moorecoinc

Unique swivel casters on back legs make maneuverability as easy as lifting and rolling.

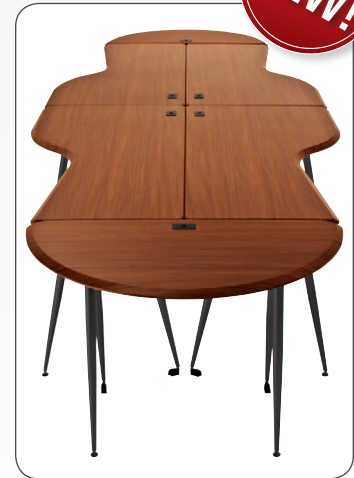

Please refer to p. 2 for a description of symbols.

iFlex™ Modular Desking

- » With logical design and modern good looks, the iFlex™ Modular Desking provides the ultimate in flexibility for designing your office, conference room, or board room.
- » GREENGUARD Indoor Air Quality Certified™ and GREENGUARD Children & Schools Certified™.
- » Ergonomic and attractive curves create workspace comfort.
- » Surface finished in teak or cherry woodgrain vacuum-formed PVC. Grommets included. Silver legs standard. Cherry finish available with new black legs.
- » Assembly is easy, and tables are a snap to move with stable glides on front legs and swivel casters on back legs. Ganging device included to join tables together.
- » TAA compliant. Tested to support up to 300 lbs.

● iFlex™ Large Desk - Right

Part No.	Color	Dimensions	Ship Wt.	Price
90049	Teak/Silver	29"H x 65"W x 31"D	79 lbs	\$436.49
90000	Cherry/Silver	29"H x 65"W x 31"D	79 lbs	\$436.49
90016	Cherry/Black	29"H x 65"W x 31"D	79 lbs	\$415.70

● iFlex™ Large Desk - Left

Part No.	Color	Dimensions	Ship Wt.	Price
90051	Teak/Silver	29"H x 65"W x 31"D	79 lbs	\$436.49
90001	Cherry/Silver	29"H x 65"W x 31"D	79 lbs	\$436.49
90117	Cherry/Black	29"H x 65"W x 31"D	79 lbs	\$415.70

● iFlex™ Small Half Round

Part No.	Color	Dimensions	Ship Wt.	Price
90057	Teak/Silver	29"H x 48"W x 24"D	42 lbs	\$339.00
90003	Cherry/Silver	29"H x 48"W x 24"D	42 lbs	\$339.00
90119	Cherry/Black	29"H x 48"W x 24"D	42 lbs	\$339.00

● iFlex™ Large Half Round

Part No.	Color	Ship Wt.	Price
90060	Teak/Silver	29"H x 62"W x 24"D	53 lbs \$400.21
90004	Cherry/Silver	29"H x 62"W x 24"D	53 lbs \$400.21
90120	Cherry/Black	29"H x 62"W x 24"D	53 lbs \$400.21



Please refer to p. 2 for a description of symbols.

Agility Tables

- » Multifunctional Agility Tables can be set up in less than five minutes. Simply lift the top, unfold the legs and secure top to base with built-in connectors.
- » GREENGUARD Indoor Air Quality Certified® and GREENGUARD Children & Schools Certified™.
- » Tables join with corner connectors, allowing multiple configurations. Ideal for training rooms, conference rooms, or for use as an office suite.
- » Steel base with built in storage shelf and casters.
- » TAA compliant. Tested to support up to 300 lbs.

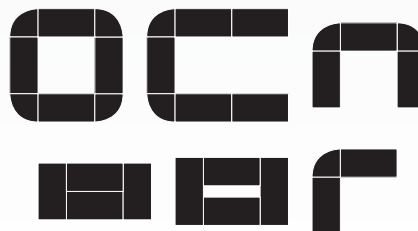

Part No.	Dimensions	Ship Wt.	Price
89959	29 1/2"H x 60"W x 24"D	52 lbs	\$579.00
89960	29 1/2"H x 72"W x 24"D	64 lbs	\$639.00
89961	29 1/2"H x 60"W x 30"D	64 lbs	\$698.00
89962	29 1/2"H x 72"W x 30"D	72 lbs	\$775.00
89964*	1 1/2"H x 24"W x 24"D	12 lbs	\$179.00
89966*	1 1/2"H x 30"W x 30"D	15 lbs	\$209.00



Modular Conference Tables

- » Modular Conference tables are available in two shapes for multiple arrangement options.
- » GREENGUARD Indoor Air Quality Certified® and GREENGUARD Children & Schools Certified™.
- » Heavy duty mahogany high pressure laminate top with black T-mold banding. Powder-coated steel legs with 4" casters (two locking). Leg extensions with glides are included. Tested to support up to 300 lbs.
- » Radius table includes a built-in electrical assembly with networking ports hidden beneath a flip-up lid.

Part No.	Dimensions	Ship Wt.	Price
89883	29 1/2"H x 63"W x 31 1/4"D	82 lbs	\$830.27
89915	29 1/2"H x 63"W x 43"D	95 lbs	\$1,095.41



Please refer to p. 2 for a description of symbols.

■ In Stock: ships within 48 hours of order. ■ Quick Ship: ships within 7 days of order.
*Ships UPS. **Ships UPS + \$9.00 handling fee.

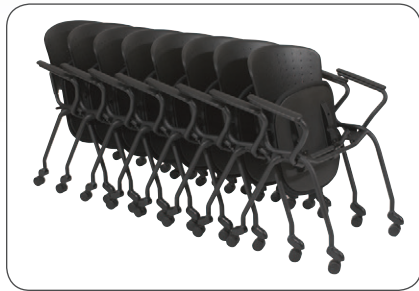

Please refer to p. 2 for a description of symbols.

Nesting Stacking Chair

- » Nesting Stacking chairs are ideal for assembly rooms, conference rooms or a workstation.
- » GREENGUARD Indoor Air Quality Certified® and GREENGUARD Children & Schools CertifiedSM.
- » Stack or nest up to eight chairs for easy transport and space-saving storage. Available with a padded upholstered seat or contoured plastic seat. Frame is black powder-coated steel with 2" casters.
- » Sold in sets of two chairs. Optional arms are available, sold in sets of four.
- » TAA compliant.

● Nesting Stacking Chair (set of 2)

Part No.	Dimensions	Ship Wt.	Price
■ 34474*	31 3/4"H x 26 1/2"W x 22 1/2"D	24 lbs	\$448.00

● Nesting Stacking Chair - Upholstered (set of 2)

Part No.	Dimensions	Ship Wt.	Price
■ 34473*	31 3/4"H x 26 1/2"W x 22 1/2"D	24 lbs	\$494.00

● Optional Arms

Part No.	Description	Ship Wt.	Price
■ 34475*	2 pair (4 arms)	3 lbs	\$99.00



Please refer to p. 2 for a description of symbols.

Nester Chair

- » The Nester chair is equally fit for use with a conference table or with a computer workstation.
- » GREENGUARD Indoor Air Quality Certified® and GREENGUARD Children & Schools CertifiedSM.
- » Black rounded molded plastic back features a built-in handle. Integrated curved armrests provide natural positioning and comfort.
- » Seat folds up and chairs nest up to eight deep for easy transport and space-saving storage.
- » Black powder-coated steel frame includes 2" casters.
- » TAA compliant.

● Nester Chair (set of 2)

Part No.	Dimensions	Ship Wt.	Price
■ 34426*	32 1/2"H x 24 1/2"W x 19 1/4"D	28 lbs	\$257.00



Please refer to p. 2 for a description of symbols.

Butterfly Chair

- » Combining an impressive array of ergonomic features with a modern and elegant design, The Butterfly Chair gives you total control over your seating experience at a price point no one can beat.
- » Engineered to support the body in all-day comfort and provide comfort for a wide spectrum of body types.
- » Stylish and breathable mesh back includes angle adjustment, tilt-lock in three positions, and tilt tension control. Contoured to provide optimum and natural lumbar support.
- » Adjust the padded, upholstered seat depth and angle with a synchro-tilt mechanism. Seat height adjusts easily on a smooth pneumatic cylinder.
- » Curved headrest is breathable, height adjustable, and angle adjustable to give correct neck support whether upright or reclining.
- » Arm rests pivot and are height adjustable to work with a variety of work spaces, positions, and activities.
- » Includes durable 5-star base with dual-wheel casters for smooth mobility.

Butterfly Chair

Part No.	Dimensions	Ship Wt.	Price
34729*	51"H x 28"W x 24"D	49 lbs	\$1,038.60

■ In Stock: ships within 48 hours of order. ■ Quick Ship: ships within 7 days of order.
*Ships UPS. **Ships UPS + \$9.00 handling fee.



Please refer to p. 2 for a description of symbols.

Posture Perfect

- » The Posture Perfect provides ergonomic features not available in any other chair.
- » GREENGUARD Indoor Air Quality Certified® and GREENGUARD Children & Schools Certified™.
- » Full-floating lumbar support panel is padded and curved to match the shape of the spine.
- » Upholstery fabric is stain-resistant and durable, with flame-resistant foam padding. Meets the flammability requirements of California Bureau of Home Furnishings Technical Bulletin 117.
- » BIFMA-approved tilt adjustment. Seat adjusts pneumatically from 16" to 20" in height. 5-star base includes 2" dual-wheel casters.
- » TAA compliant.

Posture Perfect

Part No.	Dimensions	Ship Wt.	Price
■ 34571*	44"H x 26"W x 21"D	38 lbs	\$830.27



Please refer to p. 2 for a description of symbols.

Spine Align®

- » The Spine Align® provides ergonomic back comfort not available in any other chair.
- » GREENGUARD Indoor Air Quality Certified® and GREENGUARD Children & Schools Certified™.
- » Dual full-floating padded lumbar support panels curve naturally with the spine.
- » Upholstery fabric is stain-resistant and durable, with flame-resistant foam padding. Meets the flammability requirements of California Bureau of Home Furnishings Technical Bulletin 117.
- » BIFMA-approved tilt adjustment. Seat adjusts pneumatically from 16" to 20" in height. 5-star base includes 2" dual-wheel casters.
- » TAA compliant.

Spine Align®

Part No.	Dimensions	Ship Wt.	Price
■ 34556*	44"H x 26"W x 21"D	38 lbs	\$814.54

We've Got Your Back®



See product video online!
youtube.com/moorecoinc



Scan this QR code to watch this product's online video.



Please refer to p. 2 for a description of symbols.

Ergo Ex

- » The Ergo Ex is designed to provide unmatched comfort and unmatched customizability.
- » GREENGUARD Indoor Air Quality Certified® and GREENGUARD Children & Schools CertifiedSM.
- » Padded and contoured seat measures a generous 21"W x 19"D. Seat slides forward and backward. Height adjustable from 18" to 21 3/4".
- » Stylish mesh back (22 1/2"H x 20 1/2"W) tilts and includes adjustable lumbar support device. Padded headrest tilts and is height adjustable.
- » Arm rests swivel from side to side, slide back and forth, and adjust in height.
- » Includes a durable 5-star base with casters for easy maneuverability.
- » TAA compliant.

Ⓢ Ergo Ex

Part No.	Dimensions	Ship Wt.	Price
■ 34434*	51"H x 28"W x 24"D	49 lbs	\$690.90



Please refer to p. 2 for a description of symbols.

Seatflex® Executive Chairs

- » Seatflex® executive chairs feature an elastic band back that conform to each user's shape. Choose from elastic band or upholstered seat model.
- » Includes height adjustable padded arms and a padded head rest.
- » Black steel frame curves with the spine. One-handed tilt, rock, and recline adjustment.
- » 5-star base with dual-wheel casters.
- » TAA compliant. GREENGUARD Indoor Air Quality Certified® and GREENGUARD Children & Schools CertifiedSM.

Ⓢ Seatflex® Executive Chair

Part No.	Dimensions	Ship Wt.	Price
■ 34422*	46"H x 20"W x 18 1/2"D	38 lbs	\$430.58

Ⓢ Seatflex® Executive Chair - Upholstered

Part No.	Dimensions	Ship Wt.	Price
■ 34449*	46"H x 20"W x 18 1/2"D	40 lbs	\$469.51



■ In Stock: ships within 48 hours of order. ■ Quick Ship: ships within 7 days of order.
 *Ships UPS. **Ships UPS + \$9.00 handling fee.



Tested to support up to 500 lbs in all day comfort!



Please refer to p. 2 for a description of symbols.

Titan Chair

- » Specially designed Titan Chair supports big and tall frames in all day comfort. Tested to support up to 500 lbs!
- » GREENGUARD Indoor Air Quality Certified® and GREENGUARD Children & Schools Certified™.
- » Padded and upholstered seat and back provide long lasting support. Seat measures 22 ½"W x 22"D and back measures 22"H x 21"W.
- » Exceptionally durable steel frame system. Oversized 5-star base with dual wheel casters.
- » Optional height-adjustable arms available for added comfort.

● Titan Chair

Part No.	Dimensions	Ship Wt.	Price
■ 34663*	39"-42"H x 23"W x 23"D	44 lbs	\$487.23

● Optional Arms

Part No.	Dimensions	Ship Wt.	Price
■ 34677*	12-15"H x 3 ¾"W x 10 ¾"D	3 lbs	\$130.19



C



D



D



Please refer to p. 2 for a description of symbols.

Seatflex® Managerial Chairs

- » Seatflex® managerial chairs feature an elastic band back that conform to each user's shape. Choose from elastic band or upholstered seat model.
- » Includes height adjustable padded arms.
- » Black steel frame curves with the spine. One-handed tilt, rock, and recline adjustment.
- » 5-star base with dual-wheel casters.
- » TAA compliant. GREENGUARD Indoor Air Quality Certified® and GREENGUARD Children & Schools Certified™.

● Seatflex® Managerial Chair

Part No.	Dimensions	Ship Wt.	Price
■ 34421*	40"H x 20"W x 18 ½"D	36 lbs	\$411.71

● Seatflex® Managerial Chair - Upholstered

Part No.	Dimensions	Ship Wt.	Price
■ 34448*	40"H x 20"W x 18 ½"D	37 lbs	\$347.16



Please refer to p. 2 for a description of symbols.

Reflex® Task Chair

- » The Reflex® Task Chair features a unique spring-backed self-adjustable lumbar panel. Panel automatically adjusts to the curve of the user's spine, providing unmatched fit.
- » GREENGUARD Indoor Air Quality Certified® and GREENGUARD Children & Schools Certified™.
- » Padded and upholstered seat and back for comfort. Fabric meets the flammability requirements of the California Bureau of Home Furnishings Technical Bulletin 117.
- » Seat adjusts in height from 16" to 20", and measures 19"W x 18"D.
- » 5-star silver base with dual-wheel casters.
- » Height adjustable arms (26 ¼" to 29 ¼") available.
- » TAA compliant.



● Reflex® Task Chair - (Black 34437 / Gray 34440)

Part No.	Dimensions	Ship Wt.	Price
■ 34437*	37 ½"H x 24"W x 21 ½"D	35 lbs	\$433.67
■ 34440*	37 ½"H x 24"W x 21 ½"D	35 lbs	\$413.02

● Optional Arms

Part No.	Ship Wt.	Price
■ 34438*	12 lbs	\$84.26



Please refer to p. 2 for a description of symbols.

Seatflex® Task Chairs

- » Seatflex® task chairs feature an elastic band back that conform to each user's shape. Choose from elastic band or upholstered seat model.
- » GREENGUARD Indoor Air Quality Certified® and GREENGUARD Children & Schools Certified™.
- » Black steel frame curves with the spine. One-handed tilt, rock, and recline adjustment.
- » 5-star base with dual-wheel casters.
- » TAA compliant.



● Seatflex® Task Chair

Part No.	Dimensions	Ship Wt.	Price
■ 34420*	40"H x 18 ¾"W x 18 ½"D	32 lbs	\$351.54

● Seatflex® Task Chair - Upholstered

Part No.	Dimensions	Ship Wt.	Price
■ 34447*	40"H x 18 ¾"W x 18 ½"D	29 lbs	\$347.16

Beta Sit-Stand Workstation

- » With the Beta Sit-Stand workstation improve your energy and efficiency by standing or sitting as you work, changing with ease.
- » Connect your CPU or your laptop with a LCD display or upgrade to the dual-display configuration.
- » Mobile configuration brings flexibility into the workspace. Easily moves through small doorways and over thresholds for collaborative meetings.
- » Center post works as a hub for accessory shelves, monitor mounts, and CPU holder, each independently height-adjustable. Cable management clips keep cords under control.
- » Includes single mount for a monitor up to 22". Allows up to 35° of tilt, and 25° of pan adjustment.
- » Includes angled laptop/keyboard shelf (18 3/4" x 13 3/4") with a mouse platform (6 1/4" x 6 3/4") that swivels beneath when not in use.
- » Included CPU holder adjusts in width from approximately 6" to 10".
- » Optional shelf for projector measures 15" x 11", and optional shelf for document camera shelf measures 15" x 13 3/4" with a retractable platform (13 1/2" x 8 3/4"). All shelves feature non-slip EVA pads.
- » Optional dual monitor mount holds monitors up to 22" with 35° of tilt, and 25° of pan adjustment. Handy knobs adjust the space between monitors.



Please refer to p. 2 for a description of symbols.

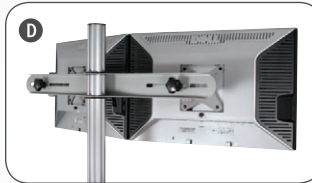

Optional dual monitor mount



Swiveling mouse platform on the included laptop/keyboard shelf

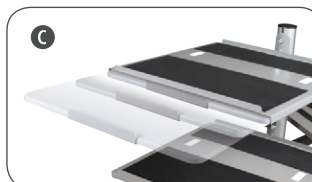

Optional document camera shelf features a retractable platform, allowing ample space for viewing materials.

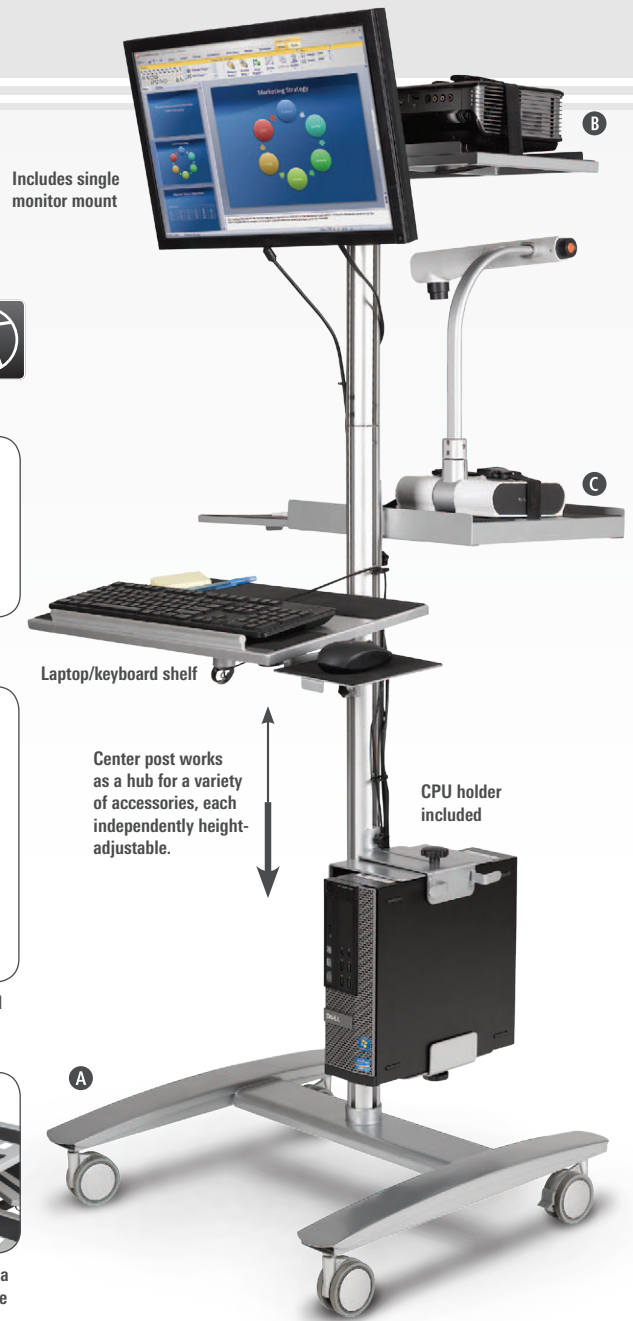

Includes single monitor mount

Laptop/keyboard shelf

Center post works as a hub for a variety of accessories, each independently height-adjustable.

CPU holder included

A Beta Sit-Stand Workstation			
Part No.	Dimensions	Ship Wt.	Price
27614	67"H x 32"W x 33"D	70 lbs	\$610.68
B Optional Projector Shelf			
Part No.	Dimensions	Ship Wt.	Price
27619*	15"W x 11"D	10 lbs	\$70.64
C Optional Document Camera Shelf			
Part No.	Dimensions	Ship Wt.	Price
27618*	15"W x 13 3/4"D	13 lbs	\$90.29
D Optional Dual Monitor Mount			
Part No.	Capacity	Ship Wt.	Price
27617*	2 monitors up to 22"	10 lbs	\$117.92



Please refer to p. 2 for a description of symbols.



Alekto

- » Versatile and compact, the Alekto is ideal for smaller or space-limited work areas.
- » Height adjustable (27 1/2" to 52 1/2") to be used as either a stand up or sit down workstation. Shelves are interchangeable, mounting high or low.
- » The retractable keyboard shelf includes a pull-out left- or right-handed mouse platform. Adjustable CPU holder can attach to either side of the workstation.
- » Silver powder-coated frame includes 3" casters (two locking).
- » TAA compliant. GREENGUARD Indoor Air Quality Certified® and GREENGUARD Children & Schools CertifiedSM.

E Alekto			
Part No.	Dimensions	Ship Wt.	Price
42551*	27 1/2" - 52 1/2"H x 30"W x 24"D	77 lbs	\$567.42



Please refer to p. 2 for a description of symbols.

Hi-Hi-Lo Workstation

- » The Hi-Hi-Lo features a compact form ideal for any smaller work area.
- » Adjusts from 31 1/4" to 39 1/4" for use as a sit down or stand up workstation.
- » Keyboard shelf can be adjusted inward and outward. Included adjustable CPU holder can be mounted on either side. Monitor shelf includes a rail, and the bottom shelf can be used to store a printer.
- » Frame is black powder-coated steel and the shelves are scratch-resistant teak laminate. Four 2" casters (two locking) are included for easy mobility.
- » TAA compliant. GREENGUARD Indoor Air Quality Certified® and GREENGUARD Children & Schools CertifiedSM.

Hi-Hi-Lo Workstation

Part No.	Dimensions	Ship Wt.	Price
46572*	31 1/4" - 39 1/4"H x 39 1/2"W x 31 1/2"D	62 lbs	\$534.40



Please refer to p. 2 for a description of symbols.

Hi-Lo Workstation

- » The Hi-Lo Workstation holds a complete computer system in a space-efficient form.
- » Adjusts from 24 3/4" to 32 1/2". Includes a security rail on the top shelf
- » Adjustable CPU holder can be mounted on either side of the desk. Keyboard shelf can be adjusted horizontally for easy access.
- » Black powder-coated steel frame includes 2" casters (two locking).
- » TAA compliant. GREENGUARD Indoor Air Quality Certified® and GREENGUARD Children & Schools CertifiedSM.

Hi-Lo Workstation

Part No.	Dimensions	Ship Wt.	Price
45972*	24 3/4" - 32 1/2"H x 39 1/2"W x 31 1/2"D	64 lbs	\$416.82



Please refer to p. 2 for a description of symbols.

Ergo E. Eazy

- » The Ergo E. Eazy adjusts instantly in height from 29" to 39" with a pneumatic lever.
- » Height adjustable keyboard platform includes a padded wrist rest, swivels from side to side, and tilts from -15° to 25°.
- » Tilting mouse platform (7"W x 8"D) can be placed on either side of the keyboard. Printer shelf (25 1/2"W x 11 3/4"D) mounts anywhere on the back of the work surface. CPU holder mounts to either side of the desk.
- » TAA compliant. GREENGUARD Indoor Air Quality Certified® and GREENGUARD Children & Schools CertifiedSM.

Ergo E. Eazy

Part No.	Dimensions	Ship Wt.	Price
82493*	29" - 39"H x 41"W x 29"D	99 lbs	\$753.81



Please refer to p. 2 for a description of symbols.

Max Stax

- » The Max Stax can be used as a stand-up workstation or as a machine stand.
- » Retractable shelf mounts high or low for use with a keyboard or office machine.
- » Top shelf includes a metal security rail to protect equipment.
- » Frame is gray powder-coated steel and includes a wrap lock panel on the bottom.
- » Includes 3" casters (two locking).
- » May be available as TAA. Please call for details.

Max Stax

Part No.	Dimensions	Ship Wt.	Price
25983*	42 1/2"H x 25 1/4"W x 20"D	46 lbs	\$376.32



Teak



Mahogany



Gray



Please refer to p. 2 for a description of symbols.

LX-48

- » With its classic good looks, the LX 48 workstation is an ideal desk for any environment.
- » GREENGUARD Indoor Air Quality Certified® and GREENGUARD Children & Schools CertifiedSM.
- » Features a ¾" thick top with a teak, mahogany, or gray vacuum-formed PVC top.
- » Locking CPU bay (23 ½"H x 14 ½"W x 21"D). Retractable keyboard shelf (22"W x 10 ½"D) with pencil holder.
- » Wire management conduits built into frame.
- » TAA compliant. 10 year guarantee.

ⓐ LX-48

Part No.	Color	Dimensions	Ship Wt.	Price
89843	Teak	29"H x 48"W x 24"D	66 lbs	\$447.10
89896	Mahogany	29"H x 48"W x 24"D	66 lbs	\$447.10
90106	Gray	29"H x 48"W x 24"D	66 lbs	\$447.10



Please refer to p. 2 for a description of symbols.

Windsurfer

- » The Windsurfer features room for a complete computer system in a space-efficient form.
- » Top shelf (36 3/4"W x 18"D) includes a security rail.
- » Retractable keyboard shelf has a mouse platform that can be used on either side.
- » Adjustable CPU holder can be attached to either side.
- » Two storage shelves included.
- » Frame is gray powder-coated steel with 2" casters (two locking).
- » TAA compliant.

ⓑ Windsurfer

Part No.	Dimensions	Ship Wt.	Price
44162*	29 ¾"H x 36 ¾"W x 18"D	41 lbs	\$226.00



Please refer to p. 2 for a description of symbols.

Z-25 Workstation

- » The Z-25 Workstation is compact, mobile, and stylish.
- » Fully articulating keyboard platform allows user to alternate between sitting and standing.
- » Platform adjusts 5" in height, swivels, and angle adjusts 21 ½° up and down.
- » Adjustable CPU holder can be attached to either side.
- » Powder-coated steel frame includes 2" casters (2 locking). Laminate shelves.
- » TAA compliant.

ⓒ Z-25 Workstation

Part No.	Dimensions	Ship Wt.	Price
42851*	30 ¾"H x 30"W x 24"D	54 lbs	\$443.67



Teak

Cherry

Unique swivel casters on back legs make maneuverability as easy as lifting and rolling.



Please refer to p. 2 for a description of symbols.



See product video online!
youtube.com/moorecoinc

iFlex™ Modular Desking

- » With logical design and modern good looks, the iFlex™ Modular Desking provides the ultimate in flexibility for designing your office, conference room, or board room.
- » GREENGUARD Indoor Air Quality Certified™ and GREENGUARD Children & Schools CertifiedSM.
- » Ergonomic and attractive curves create workspace comfort.
- » Surface finished in teak or cherry woodgrain vacuum-formed PVC. Grommets included. Silver legs standard. Cherry finish available with new black legs.
- » Assembly is easy, and tables are a snap to move with stable glides on front legs and swivel casters on back legs. Ganging device included to join tables together.
- » Optional 3-drawer file cabinets. Large drawer holds a standard hanging file rack.
- » TAA compliant. Tested to support up to 300 lbs.
- » Optional privacy panels define work areas. Outfit with attachable storage trays. Sold on page 215.



New in Cherry with black legs!



④ iFlex™ Large Desk - Right

Part No.	Color	Dimensions	Ship Wt.	Price
90049	Teak/Silver	29"H x 65"W x 31"D	79 lbs	\$436.49
90000	Cherry/Silver	29"H x 65"W x 31"D	79 lbs	\$436.49
90116	Cherry/Black	29"H x 65"W x 31"D	79 lbs	\$415.70

⑤ iFlex™ Large Desk - Left

Part No.	Color	Dimensions	Ship Wt.	Price
90051	Teak/Silver	29"H x 65"W x 31"D	79 lbs	\$436.49
90001	Cherry/Silver	29"H x 65"W x 31"D	79 lbs	\$436.49
90117	Cherry/Black	29"H x 65"W x 31"D	79 lbs	\$415.70

⑥ iFlex™ Printer Table

Part No.	Color	Dimensions	Ship Wt.	Price
90053	Teak/Silver	29"H x 31"W x 18"D	28 lbs	\$163.80
90002	Cherry/Silver	29"H x 31"W x 18"D	28 lbs	\$163.80
90118	Cherry/Black	29"H x 31"W x 18"D	28 lbs	\$163.80

⑦ iFlex™ File Cabinet

Part No.	Color	Ship Wt.	Price
90061	Teak	26 1/2"H x 13"W x 19 1/2"D	40 lbs \$197.24
90005	Cherry	26 1/2"H x 13"W x 19 1/2"D	40 lbs \$197.24

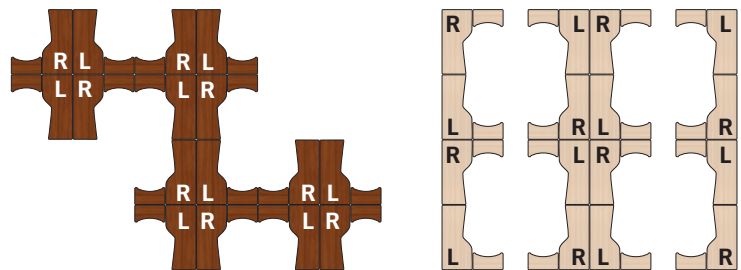



Split Level 36

Please refer to p. 2 for a description of symbols.

- » Split Level Tables feature two platforms, each adjustable from 25 1/2" to 31 1/2"H.
- » GREENGUARD Indoor Air Quality Certified® and GREENGUARD Children & Schools CertifiedSM.
- » Available in 36" W for a single user, or in 72" W for dual users (see p. XX).
- » CPU holder and a desktop grommet included.
- » Powder-coated steel frame with laminate tops. Tested to support up to 300 lbs.
- » Available as TAA compliant. Please call for details. 10 year guarantee.

A Split Level 36			
Part No.	Dimensions	Ship Wt.	Price
83681*	25 1/2" - 31 1/2"H x 36"W x 36"D	59 lbs	\$318.15

B Cable Management Tray			
Part No.	Dimensions	Ship Wt.	Price
66350*	Set of 1 - 21" long	2 lbs	\$28.00
66850*	Set of 2 - 21" long each	4 lbs	\$42.00



Please refer to p. 2 for a description of symbols.



Office In A Box

- » The Office In A Box is an all-in-one workstation that can be neatly locked away into an attractive cabinet.
- » GREENGUARD Indoor Air Quality Certified® and GREENGUARD Children & Schools CertifiedSM.
- » Doors feature 2" casters so they roll easily open and closed. Keyboard shelf and bottom shelf are retractable for easy access to equipment. Includes two storage drawers beneath the keyboard shelf and two adjustable interior shelves.
- » TAA compliant.

C Office In A Box			
Part No.	Dimensions	Ship Wt.	Price
89832	55"H x 34 1/4"W x 20 1/2"D	150 lbs	\$472.00



Please refer to p. 2 for a description of symbols.



Fold-N-Go Printer Stand on p. 213!

Fold-N-Go

- » The design of the Fold-N-Go makes it a great choice for smaller work areas.
- » Featuring release buttons on each side, the Fold-N-Go folds to a slim 4 1/2" depth.
- » Accommodates a full-size CPU, monitor and keyboard.
- » Silver metal frame with two 2" casters, and 5/8" thick black laminate surfaces.
- » Comes fully assembled for superior convenience.

D Fold-N-Go			
Part No.	Dimensions	Ship Wt.	Price
89811*	29 1/2"H x 27 1/2"W x 29 1/2"D	38 lbs	\$233.57



Please refer to p. 2 for a description of symbols.

Fold-N-Stow

- » The Fold-N-Stow's versatile design makes it ideal for any space limited work area.
- » Available in black or teak laminate. Accommodates a CPU, monitor, mouse, and a printer, and includes three drawers for storage.
- » Two top drawers measures 4"H x 9 3/4"W x 15"D. Bottom drawer (11"H x 9 3/4"W x 15"D) can hold a hanging file rack (not included).
- » Frame folds around the drawers and the work surface folds down to create a storage cabinet.
- » Silver powder-coated frame includes six locking 2" casters for easy mobility.

E Fold-N-Stow				
Part No.	Color	Dimensions	Ship Wt.	Price
89886*	Black	29 3/4"H x 41 3/4"W x 19 1/2"D	59 lbs	\$258.35
89904*	Teak	29 3/4"H x 41 3/4"W x 19 1/2"D	59 lbs	\$258.35



Lapmatic

- » The Lapmatic is the ultimate laptop stand, ergonomic and easily adjustable.
- » GREENGUARD Indoor Air Quality Certified® and GREENGUARD Children & Schools CertifiedSM.
- » Pneumatically adjusts in height from 20" to 30". Black laptop shelf is angle adjustable and a mouse can be used on either the right or left side.
- » Includes a padded wrist rest and front is curved to provide ergonomic access. Black powder-coated steel frame with casters (two locking) for easy maneuverability.
- » TAA compliant.

④ Lapmatic	Part No.	Dimensions	Ship Wt.	Price
	89829*	20" - 30"H x 28"W x 18"D	38 lbs	\$343.00



POP Laptop Stand

- » The POP Laptop Stand features a curved shape and is height adjustable from 21 1/4" to 31 1/4".
- » GREENGUARD Indoor Air Quality Certified® and GREENGUARD Children & Schools CertifiedSM.
- » Also useful as a keyboard stand or to add work space. 5-star base with 2" casters. Available with a mahogany or black top.
- » TAA compliant.

⑤ POP Laptop Stand	Part No.	Color	Dimensions	Ship Wt.	Price
	47262*	Mahogany	21 1/4" - 31 1/4"H x 25 3/4"W x 15 3/4"D	23 lbs	\$218.00
	48752*	Black	21 1/4" - 31 1/4"H x 25 3/4"W x 15 3/4"D	23 lbs	\$218.00





Please refer to p. 2 for a description of symbols.

Lapmaster

- » The Lapmaster is a deluxe laptop stand that also doubles as a small workstation.
- » Laptop shelf measures 19"W x 14 1/2"D and can be rotated 180° for use on either side.
- » Stationary surface includes two wire shelves to store paper or other office supplies.
- » Height adjustable from 27" to 39" in height.
- » Frame is black powder-coated steel with 2" casters (2 locking). Shelves are black laminate.
- » TAA compliant.

Lapmaster

Part No.	Dimensions	Ship Wt.	Price
42052*	27" - 39"H x 35 1/4"W x 20"D	34 lbs	\$286.20



Please refer to p. 2 for a description of symbols.

Lap Jr.

- » Keep your laptop handy wherever you are with the compact Lap Jr.
- » Featuring a low profile leg that can roll under a desk, the stand can be used virtually anywhere.
- » Top measures 18"W x 14"D and is height adjustable from 27" to 42"H. Angle adjustable from 45° to -45°.
- » Black powder-coated steel frame with black laminate platform.

Lap Jr.

Part No.	Dimensions	Ship Wt.	Price
89819*	27" - 42"H x 18"W x 22"D	20 lbs	\$127.00



Please refer to p. 2 for a description of symbols.



LT Table

- » The LT Table is compact and versatile. Use as a laptop desk, as a small workstation or as a supplemental table for any work area.
- » GREENGUARD Indoor Air Quality Certified® and GREENGUARD Children & Schools CertifiedSM.
- » Black powder-coated steel table is height adjustable from 27" to 36". Includes 2" casters.
- » TAA compliant.

LT Table

Part No.	Dimensions	Ship Wt.	Price
89791*	27" - 36"H x 36"W x 18"D	32 lbs	\$183.00



IS TAA

Please refer to p. 2 for a description of symbols.

LB-PR

- » Use the versatile LB-PR All-Purpose Stand to hold any office equipment in a compact space.
- » Top platform is 1" thick and measures 27"W x 25"D.
- » Two storage shelves are provided. A back wrap-lock panel provides stability and rigidity.
- » Gray powder-coated steel frame with 3" casters (two locking).
- » TAA compliant.

ⓐ **LB-PR**

Part No.	Dimensions	Ship Wt.	Price
■ 22601*	27 1/2"H x 32 1/2"W x 25"D	61 lbs	\$264.52



IS TAA

Please refer to p. 2 for a description of symbols.

Single Fax & Printer Stand

- » The compact Single Fax & Printer Stand is versatile and ideal for small spaces.
- » Bottom cabinet includes three adjustable shelves and a wire basket for paper storage.
- » Gray laminate frame includes 2" casters.
- » May be available as TAA. Please call for details.

ⓑ **Single Fax & Printer Stand**

Part No.	Dimensions	Ship Wt.	Price
■ 27502*	26 3/4"H x 17 1/2"W x 17 1/2"D	55 lbs	\$235.00



IS TAA

Please refer to p. 2 for a description of symbols.

Dual Laser Printer Stand

- » The Dual Laser Printer stand provides compact storage for two printers
- » Shelves for printers each measure 24"W x 20"D.
- » Lower shelf extends approximately 2" to provide easier access to machines.
- » Gray powder-coated steel frame includes a lower wrap-lock stability panel.
- » Moves easily on 2" casters (two locking).
- » TAA compliant.

ⓒ **Dual Laser Printer Stand**

Part No.	Dimensions	Ship Wt.	Price
■ 23701*	31"H x 24"W x 24"D	50 lbs	\$330.31



Is TAA

Please refer to p. 2 for a description of symbols.

Max Stax

- » The Max Stax can be used as a stand-up workstation or as an office machine stand.
- » Retractable shelf can be mounted in two positions for use with a keyboard or office machine.
- » Top shelf includes a metal security rail to protect equipment.
- » Frame is gray powder-coated steel and includes a wrap lock panel on the bottom.
- » Includes 3" casters (two locking).
- » May be available as TAA. Please call for details.

Max Stax

Part No.	Dimensions	Ship Wt.	Price
25983*	42 1/2"H x 25 1/8"W x 20"D	46 lbs	\$376.32



Is TAA

Please refer to p. 2 for a description of symbols.

Adjustable Printer Stand

- » The Adjustable Printer Stand is made to hold a wide variety of dot matrix printers.
- » Four top plates adjust independently from 24" to 35"W and from 6" to 29"D.
- » Paper feeds smoothly to a collection tray, keeping printouts neat and organized.
- » Gray powder-coated steel frame includes 2" casters (two locking) for easy mobility.
- » May be available as TAA. Please call for details.

Adjustable Printer Stand

Part No.	Dimensions	Ship Wt.	Price
21701*	27"H x 35"W x 29"D	30 lbs	\$231.44



Is TAA

Please refer to p. 2 for a description of symbols.

Adjustable Dual Printer Stand

- » Compactly store two printers or machines with the Adjustable Dual Printer Stand.
- » Top shelf (18"W x 18"D) adjusts from 12" to 16" above the bottom shelf.
- » Bottom slotted shelf (16"W x 14"D) extends approximately 2" for easy access.
- » Gray powder-coated steel frame with scratch-resistant gray laminate.
- » Includes 2" casters (two locking) for easy mobility.
- » TAA compliant.

Adjustable Dual Printer Stand

Part No.	Dimensions	Ship Wt.	Price
22001*	25" - 29"H x 18"W x 18"D	27 lbs	\$246.05



Please refer to p. 2 for a description of symbols.

See Fold-N-Go Workstation on p. 208!

Fold-N-Go Printer Stand

- » Designed to coordinate with the Fold-N-Go workstation, the Fold-N-Go Printer Stand features economical and space-saving design features.
- » Folding down to a compact 4 1/2" depth for compact storage and portability.
- » Top shelf measures 23 1/2"W x 17 3/4"D
- » Silver metal frame with 2" casters (two locking), and 5/8" thick black laminate shelves. Comes fully assembled.

ⓐ Fold-N-Go Printer Stand

Part No.	Dimensions	Ship Wt.	Price
■ 27514*	29 1/2"H x 23 1/2"W x 17 3/4"D	26 lbs	\$145.00



Please refer to p. 2 for a description of symbols.



Low Profile Printer Stand

- » Save valuable desktop space with the Low Profile Printer Stand.
- » Top shelf includes a security rail that doubles as a handle.
- » Store paper or other supplies on the bottom shelf for convenience.
- » The frame is brushed silver steel and the shelves are gray laminate.
- » Includes 2" casters (two locking) for easy maneuverability.
- » May be available as TAA compliant. Please call for details.

ⓑ Low Profile Printer Stand

Part No.	Dimensions	Ship Wt.	Price
■ 27501*	14"H x 17"W x 17"D	21 lbs	\$115.61



Please refer to p. 2 for a description of symbols.

Multipurpose Printer Stand

- » Save desktop space and add storage to your work area with the Multipurpose Printer Stand.
- » Includes three adjustable slide-out shelves for convenient storage.
- » Stand is available with or without 2" casters (two locking).
- » TAA compliant.

ⓒ Multipurpose Printer Stand

Part No.	Description	Dimensions	Ship Wt.	Price
■ 66554*	without casters	5 1/2"H x 18"W x 12 1/4"D	8 lbs	\$88.00
■ 66555*	with casters	7 1/2"H x 18"W x 12 1/4"D	17 lbs	\$152.00



Please refer to p. 2 for a description of symbols.



Printer & Monitor Stand

- » The Printer & Monitor Stand keeps printer off the floor or monitor at the correct height.
- » Saves valuable desktop space and includes two storage drawers.
- » Gray and black injection-molded plastic body also available with 2" casters.
- » TAA compliant.

ⓓ Printer & Monitor Stand

Part No.	Description	Dimensions	Ship Wt.	Price
■ 66556*	without casters	4 1/2"H x 18"W x 13 1/4"D	8 lbs	\$63.00
■ 66557*	with casters	6 1/2"H x 18"W x 13 1/4"D	10 lbs	\$115.00



C Flat Panel Mount Bracket

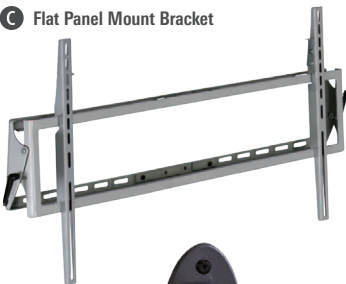

Dual Arm Monitor Mount



E Height Adjustable Monitor Mount



G Low Profile Ergonomic Monitor Mount



F Low Profile Monitor Mount

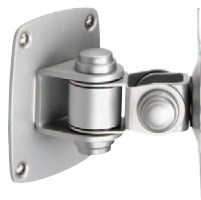

Please refer to p. 2 for a description of symbols.



Please refer to p. 2 for a description of symbols.

Desktop Flat Panel Grommet Mounts

- » Save valuable desktop space with Desktop Flat Panel Grommet mounts.
- » Both models mount through standard grommet holes and hold up to 23"/30 lbs.
- » Short grommet mount is height adjustable from 3 1/2" to 15 1/4" with 90° tilt, 110° pan, and 90° rotation.
- » Long grommet mount is height adjustable from 10 1/2" to 22 1/2". Extends forward up to 22". 90° tilt, 110° pan, and 90° rotation.
- » VESA compatible.

Long Grommet Mount

Part No.	Dimensions	Ship Wt.	Price
66606*	16 1/8"H x 22"D	10 lbs	\$211.87

Short Grommet Mount

Part No.	Dimensions	Ship Wt.	Price
66605*	16 1/8"H x 6"D	6 lbs	\$120.94

Flat Panel Wall Mounts

- » **C. Flat Panel Wall Mount Brackets** - Smaller holds flat panels up to 42" and 85 lbs. Larger holds from 42" to 61" up to 125 lbs (double stud wall installation required). VESA compatible. TAA compliant.
- » **D. Dual Arm Monitor Mount** - Holds flat panel up to 23"/30 lbs. Dual arm features 30° of tilt adjustment in either direction, 180° of pan adjustment, and 180° rotation. Quick release tab. VESA compatible. May be TAA compliant.
- » **E. Height Adjustable Monitor Mount** - Holds flat panel up to 23"/30 lbs. Height adjusts 7", features 90° of tilt adjustment, 360° pan adjustment, and 360° rotation. Quick release tab. VESA compatible. TAA compliant.
- » **F. Low Profile Monitor Mount** - Holds flat panel up to 23"/30 lbs. Features 180° of tilt and pan adjustment, and 360° rotation. VESA compatible. TAA compliant.
- » **G. Low Profile Ergonomic Monitor Mount** - Holds flat panel up to 23"/30 lbs. Features 30° of tilt adjustment in either direction, and 180° pan adjustment. Quick release tab. VESA compatible. TAA compliant.

Flat Panel Mount Bracket

Part No.	Capacity	Ship Wt.	Price
66586*	Flat panel up to 42"/85 lbs	10 lbs	\$199.36
66587*	Flat panel from 42" to 61"/125 lbs	12 lbs	\$281.95

Dual Arm Monitor Mount

Part No.	Capacity	Ship Wt.	Price
66582*	Flat panel up to 23"/30 lbs	5 lbs	\$211.17

Height Adjustable Monitor Mount

Part No.	Capacity	Ship Wt.	Price
66583*	Flat panel up to 23"/30 lbs	9 lbs	\$351.54

Low Profile Monitor Mount

Part No.	Capacity	Ship Wt.	Price
66584*	Flat panel up to 23"/30 lbs	3 lbs	\$93.20

Low Profile Ergonomic Monitor Mount

Part No.	Capacity	Ship Wt.	Price
66585*	Flat panel up to 23"/30 lbs	3 lbs	\$115.61



Shown with accessory tray set (sold below).
Available in a variety of versatile surfaces.



A

Available in tackable
or dry erase surfaces
in a variety of widths.



No tools required to attach
or remove. Panels will not
mar tabletops.



Please refer to p. 2 for a description of symbols.



B

Keep supplies
close at hand!

Desktop Privacy Panels

- » Desktop Privacy Panels define work areas, provide privacy, and help block sound without impairing visibility.
- » Attach to any work top up to from 3/4" to 1 1/2" thick without using any permanent hardware or damaging surface. Attach and reattach with ease.
- » Panels come in six sizes to fit virtually any desk or other work surface.
- » Available in porcelain steel dry erase, pebbles vinyl tackboard surface, or a combination for extra versatility.
- » Outfit with an optional set of three accessory trays (below).
- » TAA compliant.

Accessory Tray Set

- » Accessory trays add instant supply storage to any work area.
- » Attractive translucent plastic set includes a small, medium, and large size to accommodate a variety of office supplies.
- » Feature a 2mm lip to hang items securely and easily in reach while saving desktop space.
- » Trays attach easily to our Desktop Privacy Panels, Hang-Up Board, or D.O.C. Partition.

A Desktop Privacy Panels								
Porcelain	Vinyl	Combo	Length	Dimensions	Ship Wt.	Price(Por)	Price(Vinyl)	Price (Comb)
90134*	90136*	n/a	21 1/2"	17"H x 21 1/2"W x 1"D	6 lbs	\$159.00	\$104.00	n/a
90137*	90138*	n/a	32"	17"H x 32"W x 1"D	8 lbs	\$215.00	\$142.00	n/a
90139*	90140*	n/a	41"	17"H x 41"W x 1"D	11 lbs	\$245.00	\$159.00	n/a
90133*	90135*	n/a	48"	17"H x 48"W x 1"D	12 lbs	\$263.00	\$166.00	n/a
90142*	90143*	90144*	58"	17"H x 58"W x 1"D	15 lbs	\$323.00	\$202.00	\$266.00
90146*	90147*	90148*	66"	17"H x 66"W x 1"D	17 lbs	\$375.00	\$226.00	\$302.00

B Accessory Tray Set			
Part No.	Description	Ship Wt.	Price
661PT*	Set of 3 trays	6 lbs	\$28.74



Please refer to p. 2 for a description of symbols.

Rolax

- » The Rolax ergonomic foot rest features textured plastic roller balls to bring relief to sore and weary feet.
- » Platform is padded and easy sliding angle adjustment relieves leg pressure and improves circulation.
- » Gray textured fabric with a gray metal frame.

Part No.	Dimensions	Ship Wt.	Price
61710*	5"H x 17"W x 14"D	5 lbs	\$51.98



Mobile File Cabinets

- » Black steel mobile filing cabinet fits neatly under most desks and work surfaces. Casters provide easy mobility.
- » Available in two- or three-drawer configurations.
- » TAA compliant.



Please refer to p. 2 for a description of symbols.

Part No.	Dimensions	Ship Wt.	Price
27556	24"H x 15"W x 23"D	30 lbs	\$304.50
27557	24"H x 15"W x 23"D	35 lbs	\$304.50



See product video online!
youtube.com/moorecoinc

We believe that the future of our environment depends on the commitment we make as a corporation to protecting non-renewable resources and creating products that contribute to the creation of more healthful indoor environments.

Our commitment also includes changing our day to day business practices, including recycling, composting, and using renewable energy. These practices enhance our product quality, making them more attractive and viable in today's marketplace while embracing our customers' needs and desires for more responsible product.

To that end, we are proud to showcase our line of third party certified products that manifest that commitment to a greener world today and tomorrow.



Scan this QR code to watch our corkboards online video.



What does Cradle to Cradle® Mean to Me?

Cradle to Cradle® Certification is a multi-attribute eco-label that assesses a product's safety to humans and the environment and design for future life cycles.

The program provides guidelines to help businesses implement the Cradle to Cradle® framework, which focuses on using safe materials that can be disassembled and recycled as technical nutrients or composted as biological nutrients.

MBDC's certification program takes a comprehensive approach to evaluating the sustainability of a product and the practices employed in manufacturing the product.

The materials and manufacturing practices of each product are assessed in five categories:

- **Material Health**
- **Material Reutilization**
- **Renewable Energy Use**
- **Water Stewardship**
- **Social Responsibility**

For more information on the C2C® program, visit www.c2ccertified.com.

What does GREENGUARD Certified Mean to Me?

The GREENGUARD Environmental Institute (GEI) has established performance-based standards to define products and processes with low chemical and particle emissions for use indoors.

The GREENGUARD Indoor Air Quality Certification ProgramSM assures that products designed for use in office environments and other indoor spaces meet strict chemical emissions limits, which contribute to the creation of healthier interiors.

GREENGUARD Indoor Air Quality Certification requires:

- **Accurate emissions testing**
- **Review of data according to indoor air quality standards**
- **Risk evaluations recommended and provided by key public health agencies**
- **Ongoing product performance verification**

GREENGUARD Certified products are tested and reviewed for more than 10,000 individual volatile organic compounds (VOCs) and required to meet stringent health-based emission levels for over 350 of these individual VOCs.

For more information on the GREENGUARD program, visit www.greenguard.org.

The Surface is the Difference!

Heavy Use: Porcelain Steel

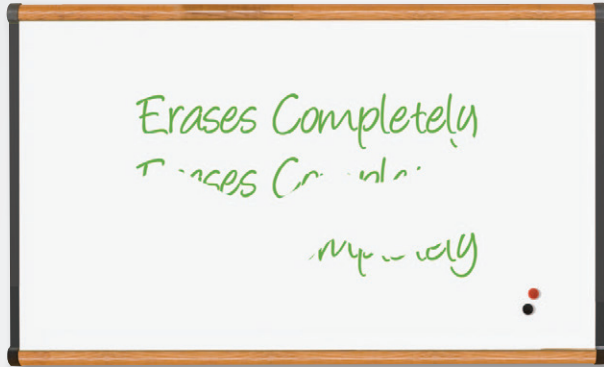

For executive offices and conference rooms

- Magnetic surface doubles as a bulletin board.
- 50 year guarantee - Will not dent, scratch, stain, or ghost.
- Engineered for superior color contrast and reduced light distortion to relieve eye strain.
- Designer frames in assorted sizes and finishes for any environment.
- Made in the USA. TAA compliant. GREENGUARD Indoor Air Quality Certified® and GREENGUARD Children & Schools Certified™.

Frequent Use: Dura-Rite®

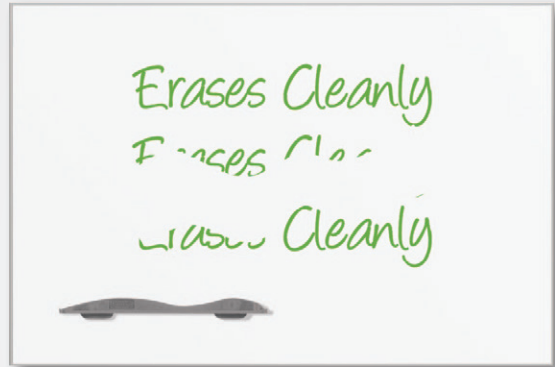

For meeting rooms, personal workspaces/offices and common areas

- Wear-resistant and dust-free surface at an affordable pricepoint.
- 20 year guarantee.
- HPL surface provides smooth writability and easy erasability.
- Designer frames in assorted sizes and finishes for any environment.
- Made in the USA. TAA compliant.

Moderate Use: Magne-Rite

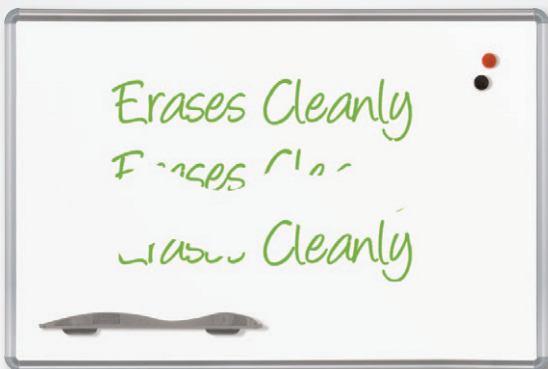

For training rooms, personal workspaces/offices and common areas

- Magnetic surface doubles as a bulletin board.
- 10 year guarantee.
- PVC-coated steel is smooth with exceptionally clean erasability.
- Designer frames in assorted sizes and finishes for any environment.

Light Use: TuF-Rite™

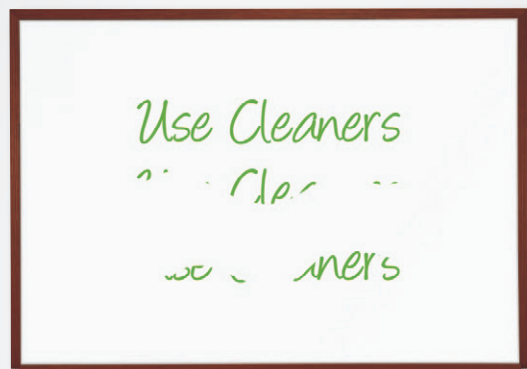

For breakrooms, factory floors, or low traffic areas

- Durable thermal fused technology provides longer-lasting performance than standard melamine boards.
- Use of a cleaner recommended for optimum performance.
- 5 year guarantee.
- Available in aluminum or wood trims.



Deluxe Aluminum Trim

Heavy duty 1" aluminum trim includes a full-length enclosed tack rail along the top, and a full-length blade accessory tray with Dura-Safe® rubber end caps for extra safety. Writing surfaces only.

Slim Frame

Slim anodized trim includes aluminum corner caps for extra style and protection. A full-length accessory tray with matching plastic end caps is included.



Presidential Trim & Brite Trim

Rounded 1" wide lengths of anodized aluminum are joined with curved, injection-molded plastic corners for smooth lines. Presidential available in silver or black. Brite Trim available in blue, green, or red.

Standard Aluminum Trim

A clean-lined anodized aluminum frame matches any decor. Hairline mitered corners and single lengths of aluminum eliminate unsightly seams.

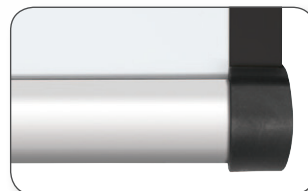
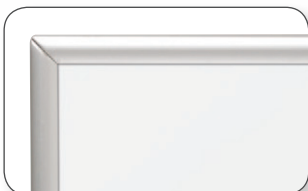

Ultra Trim

A slim, ultra low profile 5/8" aluminum trim adds a clean and modern element to any environment. The minimalist trim emphasizes functionality. Writing surfaces include a matching Q-Tray for accessories.

Origin™ Trim

Mix and match aluminum with wood for an eclectic and elegant board. Rounded top and bottom trim available in natural oak or mahogany tone wood, or in silver anodized aluminum. Side trim in black anodized aluminum. Writing surfaces include a matching Q-Tray for accessories.



Élan Trim

A unique angled profile on solid wood trim in natural oak or mahogany creates a fashion forward board. Corners are accented with brushed aluminum caps that emphasize the angles and planes. Writing surfaces include a matching brushed aluminum accessory tray.

Solid Oak Trim

A traditional frame made of 100% solid oak is available with either a natural or mahogany finish. Boards with a writing surface include a full-length solid wood accessory tray with rounded corners.

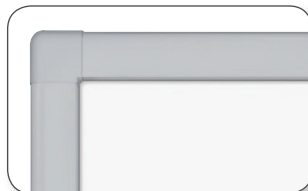

Smartest Companion Trim



Elegant and contemporary Smartest Companion Trim coordinates seamlessly in any environment. Designed to integrate with other major touchboard brands.

OneBoard™ Companion Trim



Designed to match the trim of the OneBoard™ Interactive Whiteboard, the OneBoard™ Companion Trim coordinates seamlessly in any environment.

Best-Rite® Board Surfaces



Porcelain Steel

Environmentally friendly, magnetic, 50 year guarantee.

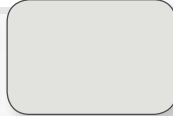

Projection Plus®

Damp erase, magnetic porcelain steel, matte gray, perfect for projection.



Magne-Rite

Magnetic PVC-coated steel dry erase surface, 10 year guarantee.



Dura-Rite®

Durable HPL dry erase surface, 20 year guarantee.



TuF-Rite™

Economical thermal fused dry erase surface.



Visionary™ White

Glossy white glass surface.



Visionary™ Gray

Matte gray glass surface.

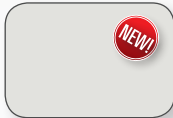

Evolution Projection

Matte gray dry erase and projection surface.

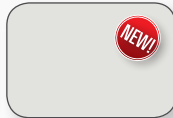

Elemental™ Gray

Matte gray dry erase & projection surface. Peel & stick.



Elemental™ White

Glossy white dry erase surface. Peel & stick.



P.S. Chalkboard (20)

Standard Green (20). Porcelain steel magnetic surface, 50 year guarantee.



P.S. Chalkboard (23)

Custom Black (23). Porcelain steel magnetic surface, 50 year guarantee.



Valu-Rite Chalkboard

Durable HPL chalkboard surface, 20 year guarantee.

Cork Collection



Natural Cork (01)



Black Splash-Cork (90)

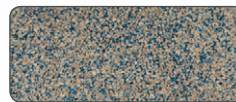

Blue Splash-Cork (92)

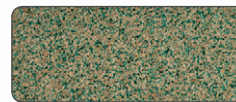

Green Splash-Cork (94)

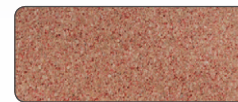

Red Splash-Cork (93)

Standard Vinyl Collection



Antique White (45)



Burgundy (42)



Champagne (41)



Cotton (46)



Gray (44)



Natural (57)



Pacific Blue (47)



Sterling (77)



Pelican (74)



Platinum (56)



Powder Blue (54)



Sierra (51)



Strawberry (53)



Teal Green (49)



Yellow Bouquet (40)

Pebbles Vinyl Collection

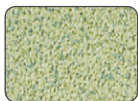

Celery (83)

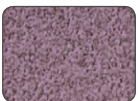

Claret (68)



Country Stone (70)



Cream (66)



Dune (85)

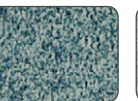

Hedgerow (71)

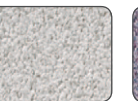

Light Quarry (67)

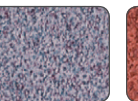

Plum (69)



Red Hot (84)

Recycled Rubber Collection



Black (96)

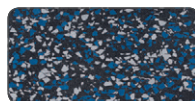

Blue (97)

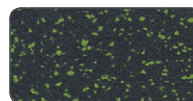

Green (104)

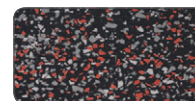

Red (99)

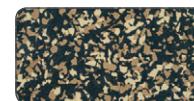

Tan (95)

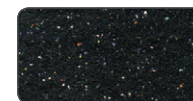

ReTire (106)

Fabric Collection



Crimson (58)



Granite (36)



Indigo (35)



Nutmeg (33)



Spruce (32)

Color swatches not guaranteed for color accuracy. If exact color matching is required, please contact customer care for color samples.

Symbols

2-n-1 Tabletop Easel 173
6-n-1 Easel 171, 221

A

ABC Trim 27, 29, 30, 31, 35
accessories 3, 32, 33, 34
Accessories 3, 24, 27, 31, 32, 33, 34, 159, 178, 179, 180, 181, 182, 190, 191, 214, 215, 216, 221
Accessory Boards 3, 183
Accessory Tray Set 183, 215
Add-A-Carrel 143
Adjustable Dual Printer Stand 212
Adjustable Laptop Utility Cart 113, 114
Adjustable Printer Stand 212
Administration 3, 176, 177, 178, 179, 180, 181, 182, 183, 184, 185, 186, 187, 188, 189, 190, 191, 192, 193, 194, 195, 196, 197, 198, 199, 200, 201, 202, 203, 204, 205, 206, 207, 208, 209, 210, 211, 212, 213, 214, 215, 216
Agility Table 135, 197
Aleкто 204
All-Service 115
All-Steel Presentation Cart 106
All-Steel Utility Carts 114
All Weather Herald 9
Alpha Cart 7, 107
Aluminized Steel 3, 20, 21
Aluminized Steel Markerboards 3
Aluminum Trim 22, 24, 25, 26, 29, 30, 35, 36, 37, 38, 39, 40, 41, 42, 43, 44, 219
antimicrobial 14, 15, 38, 99, 116, 130, 131, 195
Architectural Boards 3, 47, 48
Audio/Visual 3, 90, 91, 92, 93, 94, 95, 96, 97, 98, 99, 100, 101, 102, 103, 104, 105, 106, 107, 108, 109, 110, 111, 112, 113, 114, 115, 116, 117, 118, 119, 120, 121

B

Beta Sit-Stand Workstation 5, 204
Big & Tall Seating 3
Black Splash-Cork Tackboard 186
Boss 109
Brawny 10, 11, 137
Brite Bulletin Bars 78
Brite Kids® 8 Compartment Storage Unit 163
Brite Kids® 9 Compartment Storage Unit 163
Brite Kids® 24 Compartment Storage Unit 164
Brite Kids® Book Stand 162
Brite Kids® Chairs 160
Brite Kids® Coat Locker 164
Brite Kids® Tables 161
Brite Trim 27, 39, 219
Bulletin Bars 78
Bulletin Board Cabinet 79, 80, 81, 82, 83
Bulletin Board Cabinets 3, 9, 79, 80, 81, 82, 83, 222
Butterfly Chair 176, 199

C

Cable Management Tray 138, 159, 208
Carrels 3, 142, 143, 144, 145, 146, 147, 148, 149, 223
Cart Wheasel® 168
Cases & Cabinets 3, 79, 80, 81, 82, 83, 84, 85, 86, 87, 88, 89
Chairs 4, 12, 14, 123, 134, 150, 154, 160, 201, 202, 203, 221, 222
chalkboard 3, 35
Chalkboards 3, 35
Champ 112
Chi Flipper Seminar Table 6, 132
Chi Flipper Tables 126, 127, 129, 194
Circulation Chair 156
Circulation Stack 153
Circulation Stool 156
Circulation Task Chair 128, 131, 156
Class A Fire Rated 24, 25, 27, 41, 180, 181
Clean-Tak Tackboard 42
Colored Cork 3, 40, 52, 78

Colored Cork Tackboard 40
Colored Cork Tackboards 3
combination board 3, 45, 46
Combination Boards 3, 45, 46
Command Center 110
Computer Security/Charging Carts 3
Conference Room Boards 3, 189, 190
Conference Room Cabinets 3, 191
Conference Room Seating 3, 198, 221
Conference Room Tables 3, 192, 193, 194, 195, 196, 197
Convertible Easel 57
Coordinate Line Surface 28
cork 3, 23, 36, 37, 38, 40, 44, 52, 59, 61, 63, 64, 66, 67, 77, 78, 79, 80, 82, 185, 189, 190, 220
Cork 3, 23, 36, 37, 38, 39, 40, 44, 45, 52, 59, 61, 63, 64, 66, 67, 77, 78, 79, 80, 82, 185, 186, 189, 190, 220
Corner Workstation 141
Counter Height Display Case 88
Cradle to Cradle 24, 36, 180, 181, 184, 186, 217
CRT TV Carts 115
custom 3, 10, 11, 122
Custom 3, 6, 10, 11, 12, 13, 14, 15, 16, 17, 23, 49, 88, 89, 122, 130, 131, 137, 139, 192, 195, 220
custom color 4, 10
custom furniture 3, 10, 11, 122
Custom Furniture Guide 3, 10, 11, 122

D

Deluxe Aluminum Trim 22, 24, 25, 26, 29, 30, 35, 219
Deluxe Bulletin Board Cabinet 80
Deluxe Conference Room Cabinet 191
Deluxe Directory Board Cabinet 84
Deluxe Reversible Board 60
desk 6, 117, 136, 139, 140, 205, 206, 210, 215
Desk Accessories 3, 159, 221
Desktop Flat Panel Grommet Mounts 214
Desktop Privacy Panels 215
Directory Board Cabinet 84, 85, 86
Directory Board Cabinets 3, 84, 85
display 12, 14, 23, 66, 67, 69, 73, 74, 75, 76, 77, 78, 80, 89, 96, 97, 98, 99, 100, 101, 173, 177, 204
Display Cases 3, 79, 80, 81, 82, 83, 84, 85, 86, 87, 88, 89
Display Panels 3, 72, 73, 74, 75, 76, 77, 166, 222, 223
Display Rails 3, 77, 78, 223
Diversity Stand 112
D.O.C. Partition 23, 123, 127, 134, 215
Document Camera Security Carts 102
Dry Erase Board Accessory Kit 34
Dry Erase Board Kit 34
Dual Adjustable Laptop Utility Cart 113
Dual Arm Monitor Mount 214
Dual Laser Printer Stand 211
Dura-Rite 3, 29, 56, 59, 61, 63, 64, 66, 182, 183, 218, 220
Dura-Rite® Markerboard 29, 182
Dura-Rite® Markerboards 3

E

Early Childhood 3, 27, 160, 161, 162, 163, 164, 165, 166, 167, 168, 169, 170, 171, 172
easel 3, 45, 46
Easels 3, 53, 54, 55, 56, 57, 58, 59, 167, 168, 169, 170, 171, 172, 175, 222
ecological certifications 3
Economical Study Carrel 148
Economy Flipper Tables 128, 194
Economy Tabletop Display 75
Eco Wheasel® 55
E. Eazy Workstation 136
Élan Trim 181, 185, 219
Electrical Assemblies 106, 159
electrical assembly 2, 90, 92, 96, 101, 102, 103, 108, 109, 110, 111, 114, 115, 148, 197
Electrical assembly 100, 101, 113, 114, 159
Elemental 220
Elemental™ 8, 20, 21
Elevation 4, 5, 19, 92, 93, 95, 96, 122, 126, 134
Elevation™ Mobile Stand 4, 5, 92, 93, 96, 122, 126, 134
Elevation™ Wall Mount 5, 19, 92, 95

El Grande Board 25
Elite Freestanding Display Case 89
Enclosed Bulletin Board Cabinet 79, 81, 82, 83
Enclosed Directory Board Cabinet 84, 85
Ergo E. Eazy 205
Ergo Ex 201
Euro® Reversible Board 64
Evolution 3, 20, 22, 23, 179, 220
Evolution Markerboard 22
Evolution Markerboards 3
Evolution Projection Markerboard 179
Executive Conference Room Cabinet 191
Executive Seating 3, 199, 200, 201, 221

F

fabric 3, 43, 77, 78, 79, 81, 82, 83, 188, 220
Fabric 3, 40, 41, 44, 52, 66, 69, 70, 71, 75, 80, 149, 187, 203, 220
Fabric Add-Cork Tackboard 44
Fabric Cork-Plate Tackboard 44
Fabric Tackboards 3
Fab-Tak Tackboard 44, 187
FDB AV Cart 108
File Cabinet 140, 207, 216
Fire Rated 24, 25, 27, 41, 180, 181
Flat Panel Mount 92, 96, 109, 214
Flat Panel Mount Bracket 109, 214
Flat Panel Stand 12, 13, 14, 15, 62, 97, 98, 99
Flat Panel Stands 3, 96, 97, 98, 99, 100, 101
Flat Panel Wall Mounts 214
Flipper Table 4, 16, 123, 124, 127, 192, 194
Flipper Training Tables 16, 17, 124
Flip Top Cable Table 138
Floor Carrel 143, 149
Floor Lectern 117
Folding Tabletop Board 173
Folding Wheasel® 55, 169
Fold-N-Go 208, 213
Fold-N-Go Printer Stand 208, 213
Fold-N-Stow 208
Furniture 3, 10, 11, 27, 122, 160, 161

G

glass board 8
 Graphic Boards 28
 graphic surface 3
 Graphic Surface Markerboards 3
 Graphic Surfaces 28
 GREENGUARD 16, 18, 24, 25, 27, 36, 37, 38, 39, 40, 41, 42, 43, 45, 46, 66, 92, 95, 96, 97, 98, 100, 101, 104, 105, 106, 108, 109, 110, 111, 112, 113, 114, 115, 117, 118, 120, 121, 124, 127, 128, 130, 133, 135, 136, 137, 138, 140, 141, 143, 144, 145, 146, 147, 148, 177, 178, 180, 181, 185, 186, 187, 188, 193, 194, 195, 196, 197, 198, 200, 201, 202, 203, 204, 205, 206, 207, 208, 209, 210, 217, 218
 Green-Rite® Markerboard 24, 180
 Grid Line Surface 28
 Grommet Mount 214
 Groove Carrel 146

H

Hang Up Board 183
 H Carrel 145
 Height Adjustable Flat Panel Cart 101
 Height Adjustable Flipper Table 4, 123, 192
 Height Adjustable Monitor Mount 214
 Height Adjustable Sound Powered Lectern 118
 Hi-Hi-Lo Workstation 205
 Hi-Lo Workstation 205
 Hook & Loop 66, 67, 72, 73, 74, 75, 174, 175
 Hook & Loop Tabletop Easel 174
 Horizontal Line Surface 28
 Horizontal Sliding Board 48

I

Ideal Easel 58
 iFlex™ Modular Desking 196, 207
 iFlex™ Seminar Tables 6
 Indoor Bulletin Board Cabinets 79, 80
 Indoor Enclosed Bulletin Board Cabinet 79, 81
 Indoor Enclosed Directory Board Cabinet 84
 Instructor Teacher's Desk 6, 139
 interactive whiteboard 3, 18, 19
 Interactive Whiteboards 3, 18, 19
 Interactive Whiteboard Stand 4, 90, 92
 Interactive Whiteboard Stands 3, 90, 91, 92, 93
 Interior Lighting Kit 79, 84
 iTeach 4, 90, 91, 94
 iTeach™ 2 4, 90, 91
 IWB 5, 19, 90

K

KD Book Truck 158

L

Lab Stool 155
 laminate 10, 12, 35, 70, 88, 89, 97, 99, 104, 106, 111, 112, 116, 117, 118, 135, 136, 138, 139, 140, 141, 142, 148, 158, 162, 163, 164, 183, 197, 205, 208, 210, 211, 212, 213
 Laminate 66, 71, 89, 206
 Language Arts 3, 173, 174, 175
 Lap Board 175
 Lap Jr. 210
 Lapmaster 210
 Lapmatic 209
 Laptop Stands/Tables 3, 210
 LB-PR 211
 Lecterns 3, 116, 117, 118, 119, 120, 222
 Lecture Station 117, 140
 Letter sets 84, 85
 Letter Sets 86
 Long Grommet Mount 214
 Low Profile Ergonomic Monitor Mount 214
 Low Profile Monitor Mount 214

Low Profile Printer Stand 213
 LT Table 210
 Lumina™ Carrel 142
 Lumina™ Flat Panel Stand 12, 13, 14, 15, 99
 Lumina™ Folding Tables 12, 13, 14, 15, 130, 133
 Lumina™ Podium 12, 13, 14, 15, 116
 Lumina™ Reversible Board 13, 15, 65, 129
 Lumina™ Room Divider 13, 15, 68
 LX 48 136, 206
 LX 72 136

M

Made in the USA 22, 23, 24, 25, 26, 27, 28, 30, 32, 35, 36, 37, 38, 39, 40, 41, 42, 43, 44, 45, 46, 48, 49, 50, 51, 52, 73, 74, 75, 79, 80, 81, 82, 83, 84, 85, 88, 89, 149, 166, 179, 180, 181, 182, 183, 184, 185, 186, 187, 188, 218
 Magne-Rite 3, 30, 182, 218, 220
 Magne-Rite Markerboard 30, 182
 Magne-Rite Markerboards 3, 30
 magnetic 8, 12, 14, 18, 23, 26, 27, 30, 33, 35, 45, 49, 50, 51, 53, 54, 55, 56, 57, 58, 68, 87, 167, 168, 169, 170, 171, 172, 173, 175, 177, 178, 180, 181, 182, 183, 190, 191, 220
 Magnetic Eraser Cloth 33, 34
 Magnetic Flannel Easel 169, 170
 Magnetic Language Easels 175
 Magnetic Q-Tray 22, 27, 33, 34, 179, 180, 181
 Managerial Seating 3, 202
 Map Rails 77
 markerboard 3, 18, 19, 20, 21, 22, 23, 24, 25, 26, 27, 28, 29, 30, 31, 32, 33, 34, 177, 178, 179, 180, 181, 182
 Markerboard 3, 8, 9, 20, 22, 24, 25, 26, 27, 29, 30, 31, 32, 33, 34, 45, 46, 49, 50, 51, 57, 71, 166, 175, 179, 180, 181, 182
 Markerboard Accessories 3, 32, 33, 34
 Markerboard Accessory Kits 34
 Markerboard Resurfacing 3
 Markerboards 3, 18, 19, 20, 21, 22, 23, 24, 25, 26, 27, 28, 29, 30, 31, 32, 33, 34, 177, 178, 179, 180, 181, 182
 Markers 33, 34
 Max Stax 205, 212
 Mega Easel 57
 melamine 29, 31, 35, 54, 55, 56, 97, 106, 165, 166, 182, 218
 Mentor Seminar Table 6, 134
 Message Board 183
 Metal Lectern 118
 MFE on Wheels 169
 Mini Wheasel® 55
 Mobile File Cabinets 216
 Mobile Flat Panel Stand 98
 Mobile Floor Display Panels 73
 Mobile Laptop Charging Stations 121
 Modular Conference Tables 197
 Modular Pedestal Desk 140
 Multifunctional Language Easel 170
 Multimedia Board Accessory Kit 34
 Multipurpose Printer Stand 213
 Music Line Surface 28

N

Natural Add-Cork Tackboard 38, 185
 natural cork 3, 23, 24, 36, 37, 38, 40, 44, 52, 59, 61, 63, 64, 66, 67, 77, 78, 79, 80, 82, 184, 185, 189, 190, 191, 220
 Natural Cork 3, 23, 36, 37, 38, 40, 44, 52, 59, 61, 63, 64, 66, 67, 77, 78, 79, 80, 82, 185, 189, 190, 220
 Natural Cork-Plate Tackboard 38, 185
 Natural Cork Strips 78
 Natural Cork Tackboards 3
 Navigator 9, 87
 Nest Easel 56
 Nester Chair 198
 Nester Reversible Board 59
 Nesting Stacking Chair 157, 198
 Nesting Stacking Tablet Chair 7, 150
 Nesting Stacking Tablet Chairs 150
 new 3, 5, 7, 9, 31, 49, 51, 94, 182, 184, 196, 207
 Notebook 183

O

Oak Lecterns 119
 Odyssey Charging Cart 7, 121
 Office In A Box 208
 OneBoard 190
 OneBoard™ Companion 190, 219
 Optima 5, 102, 103
 Optima EM 5, 102
 Optima LM 5, 103
 Organization 3, 158, 162, 163, 164, 165
 Origin™ Trim 181, 182, 184, 185, 219
 Oui Chair 151
 Oui Guest Chair 7
 Outdoor Bulletin Board Cabinets 9, 81, 82, 83
 Outdoor Enclosed Bulletin Board Cabinet 82
 Outdoor Enclosed Directory Board Cabinet 85
 Outdoor Headline Bulletin Board Cabinet 82
 Outdoor Headline Directory Board Cabinet 85

P

Pack Rack 165
 PBL AV Cart 111
 Pebbles Vinyl Tackboard 42, 187
 Penmanship Line Surface 28
 PJ Table 135
 Platinum Flat Panel Stand 62, 97
 Platinum Reversible Board 17, 23, 62, 63, 125
 Pneu-Lect 112
 POP Laptop Stand 209
 porcelain 3, 18, 19, 23, 24, 25, 26, 27, 28, 35, 50, 54, 55, 56, 59, 60, 61, 62, 63, 64, 66, 67, 181, 189, 190, 218, 220
 porcelain steel 3, 18, 19, 23, 24, 25, 26, 27, 28, 35, 50, 54, 55, 56, 59, 60, 61, 62, 63, 64, 66, 67, 181, 189, 190, 218, 220
 Porcelain Steel 3, 18, 19, 23, 24, 25, 26, 27, 28, 35, 50, 54, 55, 56, 59, 60, 61, 62, 63, 64, 66, 67, 181, 189, 190, 218, 220
 Porcelain Steel Chalkboard 35
 Porcelain Steel Markerboard 25, 26, 27, 181
 Porcelain Steel Markerboards 3, 26
 Portable Display Panels 74
 Portable Presentation Display 75
 Posture Perfect 200
 Preschool Dividers 166
 Presentation Cart 17, 104, 105, 106, 125
 Presidential Trim 22, 179, 180, 182, 184, 185, 186, 187, 188, 219
 Printer/Equipment Stands 3, 211, 212, 213
 Printer & Monitor Stand 213
 Privacy Study Carrel 148
 Projection Carts 3, 102, 103, 104, 105, 106, 107, 108, 109, 110, 111, 112
 projector arm 90, 91, 93, 95
 Proview AV Cart 111

Q

QR code 14, 24, 32, 36, 49, 65, 66, 68, 70, 99, 105, 109, 116, 131, 160, 201, 217
 Quest 9, 53
 Quest Star-Based Easel 53

R

Reflex® Guest Chair 107, 154
 Reflex® Task Chair 203
 Renew Stack Chair 7, 152
 Resurfacing 3, 49, 50, 51, 52
 ReTire 43, 77, 78, 188, 220
 ReTire Rubber Tackboard 43
 Retro-Finish Panel 23, 49
 return authorization 2
 return policy 2
 reversible board 3, 45, 46
 Reversible Boards 3, 12, 14, 23, 59, 60, 61, 62, 63, 64, 65, 97
 Rite-On® Deluxe Markerboard Kit 34
 Rite-On® In Reach Markerboard Kit 34

Rite-On® Markerboard Starter Kit 34
 Rite-On® Markers 33
 Rolax 216
 Rolz-2 110
 Room Dividers 3, 12, 14, 66, 67, 68, 69, 70, 71, 166
 Room Dividers & Display Panels 3, 166
 rubber 3, 43, 77, 78, 79, 81, 82, 83, 188, 220
 Rubber Tackboards 3
 Rubber-Tak 43, 79, 81, 82, 83, 188
 Rubber-Tak Tackboard 43, 188

S

Scamp 120
 Seating 3, 150, 151, 152, 153, 154, 155, 156, 157, 198, 199, 200, 201, 202, 203, 221
 Sentinel AM™ Tackboard 38
 Short Grommet Mount 214
 Signs 3, 87, 223
 Single Fax & Printer Stand 211
 Single Pedestal Directory Board 86
 Smartest Companion 189, 219
 Solid Wood Trim 26, 37
 Sound Powered Lectern 118
 space planning 70
 Spinner Easel 57
 Splash-Cork 3, 23, 36, 37, 38, 40, 44, 52, 59, 61, 63, 64, 66, 67, 77, 78, 79, 80, 82, 185, 189, 190, 220
 Splash-Cork Tackboard 39, 186
 Splash-Cork Tackboards 3
 Split Level 36 208
 Split Level 72 138
 Sports Tower 165
 Stacking Stool 7, 157
 Standard Bulletin Board Cabinet 80
 Standard Directory Board Cabinet 84
 Standard Modular Panels 69
 Standing Directory Board Cabinet 86
 Standing Directory Boards 86
 Step Stool 7, 158
 stool 7, 158
 Storage 3, 55, 98, 112, 158, 162, 163, 164, 165, 169, 170, 172, 221, 223
 Storage & Organization 3, 158, 162, 163, 164, 165
 Storage Wheasel® 55
 Study Carrel 147, 148
 Study-Rite Carrels 149
 surfaces 3, 28, 46, 51, 55, 220
 Surfaces 3, 28, 46, 51, 55, 220, 222
 Swinging Floor Display Panels 76
 Swinging Wall Display Panels 76

T

TAA compliant 2, 16, 18, 20, 23, 24, 25, 26, 27, 28, 29, 30, 32, 35, 36, 37, 38, 39, 40, 41, 42, 43, 44, 45, 46, 48, 49, 50, 51, 52, 57, 62, 64, 66, 70, 73, 74, 75, 76, 77, 79, 80, 81, 82, 83, 84, 85, 88, 89, 90, 92, 94, 95, 97, 104, 106, 108, 109, 110, 111, 112, 117, 118, 120, 121, 123, 124, 127, 128, 133, 134, 135, 136, 137, 138, 140, 141, 144, 145, 146, 147, 148, 149, 150, 151, 153, 154, 155, 156, 157, 158, 159, 166, 170, 172, 173, 177, 180, 181, 182, 183, 184, 185, 186, 187, 188, 189, 190, 192, 193, 194, 196, 197, 198, 200, 201, 202, 203, 204, 205, 206, 207, 208, 209, 210, 211, 212, 213, 214, 215, 216, 218
 Table 3, 4, 6, 10, 13, 15, 16, 91, 93, 123, 124, 127, 128, 132, 134, 135, 137, 138, 160, 161, 192, 193, 194, 195, 197, 207, 210, 221, 222
 Tables 3, 12, 13, 14, 15, 16, 17, 122, 123, 124, 125, 126, 127, 128, 129, 130, 131, 132, 133, 134, 135, 136, 137, 138, 161, 192, 193, 194, 195, 196, 197, 208, 210, 221, 222
 Tabletop Display Panel 75
 Tabletop Flannel Easel 174
 Tack Bite 9, 77
 tackboard 3, 36, 37, 38, 39, 40, 41, 42, 43, 44, 46, 184, 185, 186, 187, 188
 Tackboard Display Panels 77
 Tackboard Display Rails 77

Tackboard Resurfacing 3
 Tackboards 3, 36, 37, 38, 39, 40, 41, 42, 43, 44, 46, 184, 185, 186, 187, 188
 Tambour Door Enclosed Cabinet 191
 Task Seating 3, 203
 Teacher's Magnetic Instructional Easel (TMIE) 172
 TG-LAM 158
 The Boss 109
 Titan Chair 202
 TLC-2 167
 T-Lect 120
 TMIE 172
 TMIW 172
 Traditional Wood Display Case 89
 Training Tables 3, 16, 17, 122, 123, 124, 125, 126, 127, 128, 129, 130, 131, 132, 133, 134, 135, 136, 137, 138, 221
 Trax Stool 157
 Trek 9, 68
 Tri-Fold Information Center 74
 Trims 3, 219
 Trims & Surfaces 3
 Tubbie Tower 165
 tubs 55, 164, 165, 167, 168, 169
 TuF-Rite™ 3, 9, 31, 182, 218
 TuF-Rite™ Markerboards 3

U

USA Map Surface 28
 Utility Carts 3, 113, 114, 115, 221

V

Valu-Rite Chalkboard 35, 220
 Valu-Tak Tackboard 37
 Vin-Tak Tackboard 41, 187
 vinyl 3, 40, 41, 42, 44, 46, 51, 52, 72, 73, 74, 79, 80, 149, 166, 187, 215, 220
 Vinyl Add-Cork Tackboard 40
 Vinyl Cork-Plate Tackboard 40
 Vinyl Tackboards 3
 VT Logic Tackboard 36, 184

W

Wall Mount Display Case 88
 Weather Sentinel 9, 81
 Web AV 111
 What's New 3
 Wheasel® Pocket 54, 55
 White MICE Wheasel® 168
 Wide Body Flat Panel Cart 100, 101
 Wilsonart 10
 Windsurfer 206
 Wood Nest Easel 56
 Wood Presentation Easel 58
 Wood Trim 26, 37, 80, 84
 Wood Trim Bulletin Board Cabinet 80
 Wood Trim Directory Board Cabinet 84
 Workstations 3, 139, 140, 141, 204, 205, 206, 207, 208
 Write Angle Workstation 141

X

Xtra Long Presentation Cart 106
 Xtra Wide Presentation Cart 105

Y

youtube 24

Z

Z-25 Workstation 206

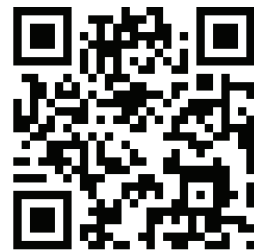
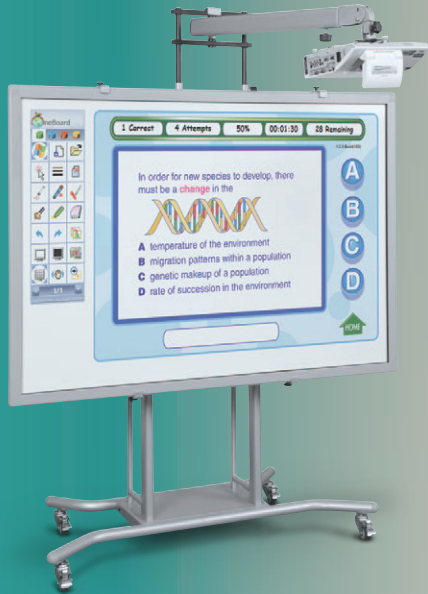
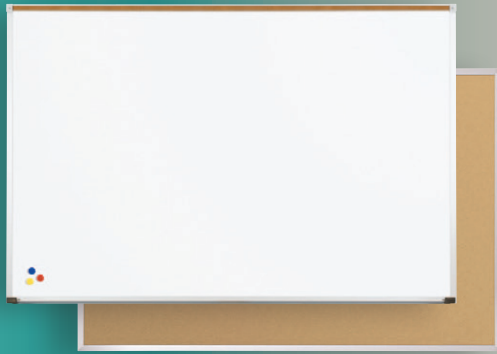

Balt® & Best-Rite® are brand divisions
of MooreCo, Inc.
2885 Lorraine Ave | Temple, TX 76501
p: 800.749.2258 | f: 800.697.6258