

The Lorell Book

2013





Welcome to The Lorell Book!

Hundreds of products with YOU in mind! We focus on quality, function, style, and selection and we do it at prices that make sense.

Quality...



Function...

Style...



Selection...

Prices that make sense.

All products are quality tested to meet or exceed BIFMA standards.

LORELL TABLE OF CONTENTS

Turn the pages to find everything you need to furnish your office!



OFFICE SUITES Pg. 2



CONFERENCE ROOM Pg. 16



BOOKCASES Pg. 18



TRAINING ROOM Pg. 22



HOSPITALITY & RECEPTION PG. 24



SEATING Pg. 30



STORAGE & FILING Pg. 52



BOARDS Pg. 62



DESKTOP ORGANIZATION Pg. 66

 Assembly needed. Please call for details. ‡Cannot be shipped UPS.

WOOD VENEER OFFICE SUITES

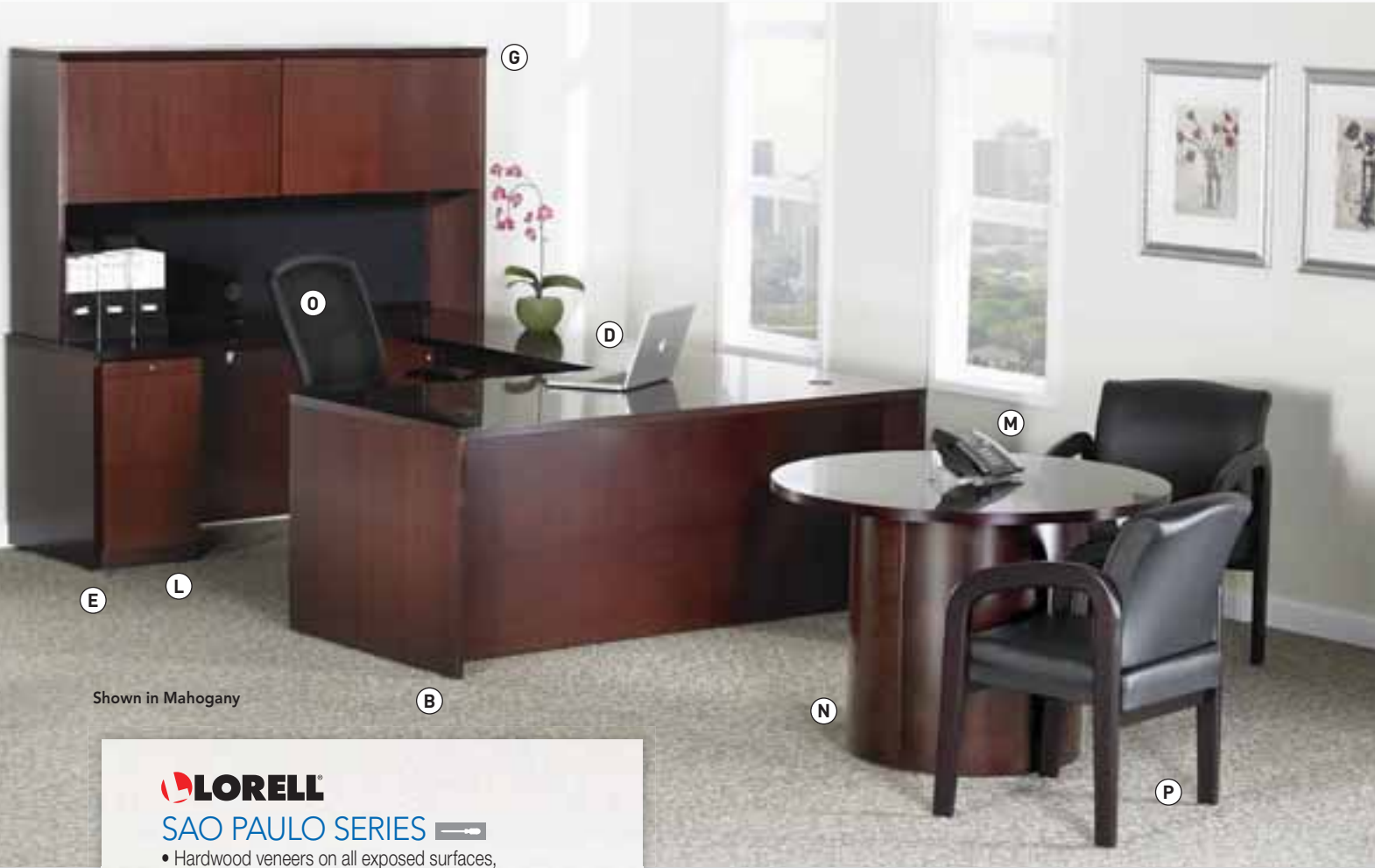

Shown in Mahogany

LORELL SAO PAULO SERIES

- Hardwood veneers on all exposed surfaces, book matched to produce a uniform grain pattern
- Fluted edges on work surfaces
- All surfaces are varnished for maximum durability
- Full modesty panels on desk and credenza shells
- Drawer fronts are vertical grain matched
- Locking pedestals and lateral files
- File drawers accommodate letter or legal filing
- Ball-bearing full extension slides on all drawers
- Covered by Lorell Limited 5-Year Warranty

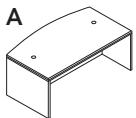

A. Bow-Front Desk Shells
72"Wx36/42"Dx29"H, Shpg. Wt. 162 lbs.
LLR 87800† Mahogany LIST PRICE
LLR 88000† Cherry \$895.00 ea

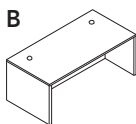

B. Rectangular Desk Shells
72"Wx36"Dx29"H, Shpg. Wt. 162 lbs.
LLR 87801† Mahogany \$825.00 ea
LLR 88001† Cherry
66"Wx30"Dx29"H, Shpg. Wt. 134 lbs.
LLR 87802† Mahogany \$675.00 ea
LLR 88002† Cherry
60"Wx30"Dx29"H, Shpg. Wt. 129 lbs.
LLR 87803† Mahogany \$650.00 ea
LLR 88003† Cherry

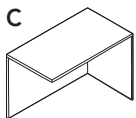

C. Reversible Returns
48"Wx24"Dx29"H, Shpg. Wt. 75 lbs.
LLR 87806† Mahogany \$395.00 ea
LLR 88006† Cherry
42"Wx24"Dx29"H, Shpg. Wt. 69 lbs.
LLR 87807† Mahogany \$370.00 ea
LLR 88007† Cherry

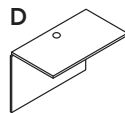

D. Bridges
48"Wx24"Dx29"H, Shpg. Wt. 58 lbs.
LLR 87808† Mahogany LIST PRICE
LLR 88008† Cherry \$370.00 ea
42"Wx24"Dx29"H, Shpg. Wt. 56 lbs.
LLR 87809† Mahogany \$350.00 ea
LLR 88009† Cherry

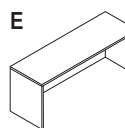

E. Credenza Shells
72"Wx24"Dx29"H, Shpg. Wt. 122 lbs.
LLR 87810† Mahogany \$685.00 ea
LLR 88010† Cherry
66"Wx24"Dx29"H, Shpg. Wt. 117 lbs.
LLR 87811† Mahogany \$660.00 ea
LLR 88011† Cherry
60"Wx24"Dx29"H, Shpg. Wt. 110 lbs.
LLR 87812† Mahogany \$620.00 ea
LLR 88012† Cherry

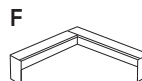

F. Reception Counters
Fit on 72" wide desk units with 48" return/
bridge attached.
70"Wx81"Dx13"H, Shpg. Wt. 97 lbs.
LLR 87804† Mahogany \$725.00 ea
LLR 88004† Cherry



Shown in Cherry
Chair shown LLR 86205

SAO PAULO SERIES

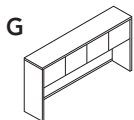

G. Stack-On Storage
70"Wx14"Dx39"H, Shpg. Wt. 147 lbs.
LLR 87813‡ Mahogany
LLR 88013‡ Cherry **\$1050.00 ea** LIST PRICE

64"Wx14"Dx39"H, Shpg. Wt. 132 lbs.
LLR 87814‡ Mahogany
LLR 88014‡ Cherry **\$945.00 ea**

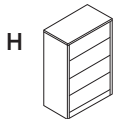

H. 4-Drawer Lateral Files
36"Wx20"Dx59 1/4"H, Shpg. Wt. 222 lbs.
LLR 87817‡ Mahogany
LLR 88017‡ Cherry **\$2310.00 ea**

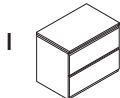

I. 2-Drawer Lateral Files
36"Wx20"Dx29"H, Shpg. Wt. 136 lbs.
LLR 87816‡ Mahogany
LLR 88016‡ Cherry **\$1199.00 ea**

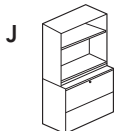

J. Stack-On Bookcases 
36"Wx13"Dx39"H, Shpg. Wt. 28 lbs.
LLR 87818‡ Mahogany
LLR 88018‡ Cherry **\$555.00 ea**



K. Box/Box/File Pedestals
To be used with Desk and Credenza Shell.
15 1/4"Wx22"Dx27 1/2"H, Shpg. Wt. 61 lbs.
LLR 87822‡ Mahogany
LLR 88022‡ Cherry **\$560.00 ea**



L. File/File Pedestals 
To be used with Desk and Credenza Shell.
15 1/4"Wx22"Dx27 1/2"H, Shpg. Wt. 61 lbs.
LLR 87823‡ Mahogany
LLR 88023‡ Cherry **\$560.00 ea**



Ribbon Edge
Detail Shown in
Cherry



P.



M. Round Table Tops 
Must order cylinder base.

46" Diameter, Shpg. Wt. 62 lbs
LLR 87825‡ Top, Mahogany
LLR 88025‡ Top, Cherry **\$555.00 ea** LIST PRICE

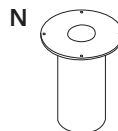

N. Cylinder Bases
Must order round table top.

22"Wx22"Dx27 1/2"H, Shpg. Wt. 53 lbs.
LLR 87826‡ Base, Mahogany
LLR 88026‡ Base, Cherry **\$450.00 ea**



O. Executive High-Back Swivel Chair
28 1/2"Wx28 1/2"Dx45"H, Shpg. Wt. 48 lbs.
LLR 86205‡ Black **\$405.00 ea**

P. Deluxe Wood Finish Guest Chairs
Padded faux leather seat and back with built-in lumbar support. Chairs are easily assembled without the use of tools due to a unique locking system. Covered by Lorell Limited 5-Year Warranty.

23"Wx25 1/2"Dx33 1/2"H
LLR 60470 Black/Cherry Frame **\$332.00 ea**

 Assembly needed. Please call for details. ‡Cannot be shipped UPS.

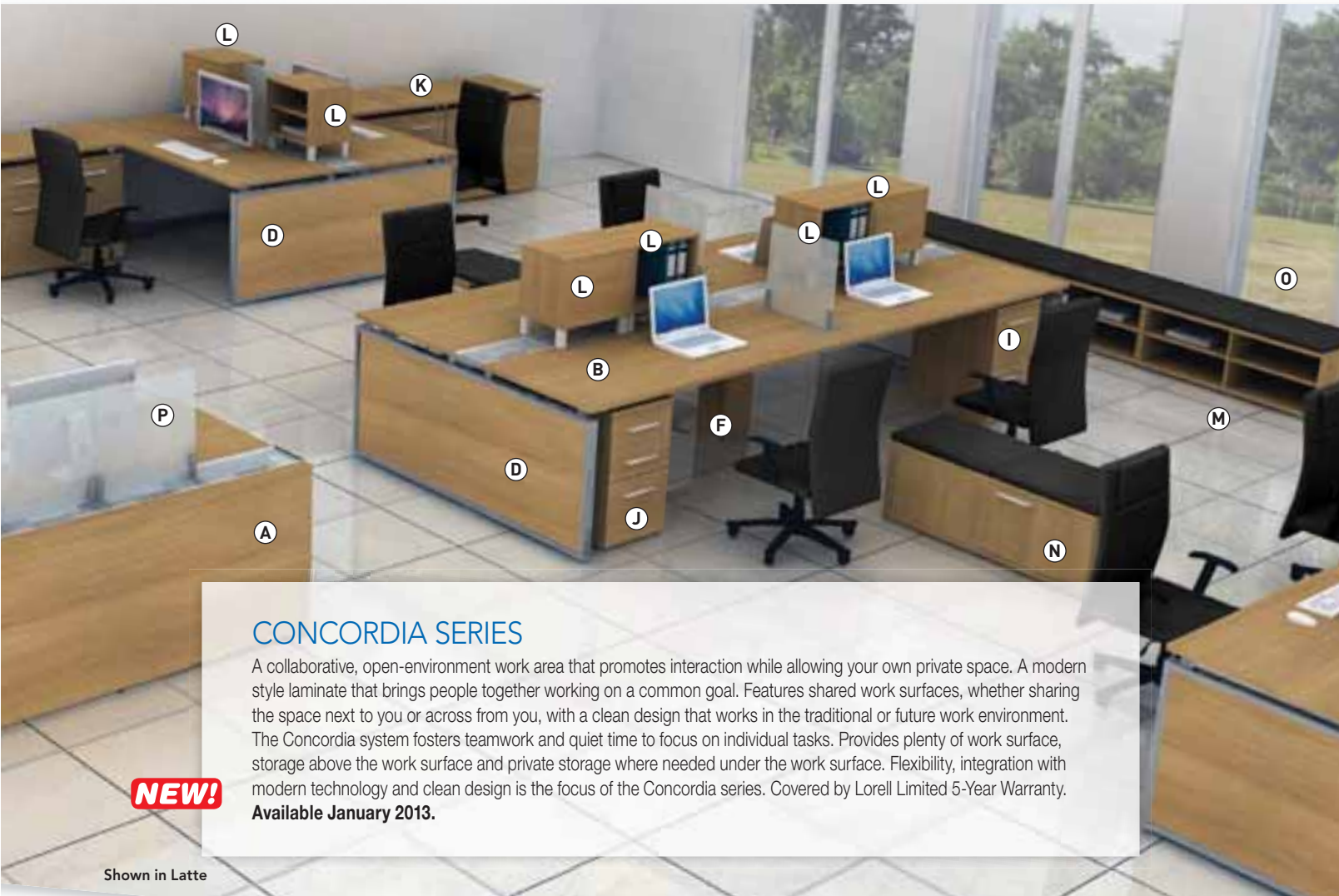

CONCORDIA SERIES

A collaborative, open-environment work area that promotes interaction while allowing your own private space. A modern style laminate that brings people together working on a common goal. Features shared work surfaces, whether sharing the space next to you or across from you, with a clean design that works in the traditional or future work environment. The Concordia system fosters teamwork and quiet time to focus on individual tasks. Provides plenty of work surface, storage above the work surface and private storage where needed under the work surface. Flexibility, integration with modern technology and clean design is the focus of the Concordia series. Covered by Lorell Limited 5-Year Warranty. Available January 2013.

NEW!

Shown in Latte

- A. Single Top Desks With Modesty Panel & Wire Channel**
3mm edge with matched color edge banding.
- | | |
|-------------------------------------|------------------------|
| 72"Wx40"Dx29½"H, Shpg. Wt. 123 lbs. | LIST PRICE |
| LLR 81911‡ Latte | \$639.00 ea |
| LLR 81910‡ Mahogany | |
| 66"Wx40"Dx29½"H, Shpg. Wt. 106 lbs. | |
| LLR 81913‡ Latte | \$602.00 ea |
| LLR 81912‡ Mahogany | |
- B. Double Top Desks With Wire Channel**
3mm matched color edge banding.
- | | |
|-----------------------------------|------------------------|
| 72"Wx67"Dx8"H, Shpg. Wt. 115 lbs. | |
| LLR 81915‡ Latte | \$599.00 ea |
| LLR 81914‡ Mahogany | |
| 66"Wx67"Dx8"H, Shpg. Wt. 101 lbs. | |
| LLR 81917‡ Latte | \$565.00 ea |
| LLR 81916‡ Mahogany | |
- C. Single Desk Legs**
39"Wx2"Dx28½"H, Shpg. Wt. 79 lbs.
- | | |
|--------------------|------------------------|
| LLR 81945‡ Latte | \$206.00 ea |
| LLR 81918 Mahogany | |

- D. Double Desk Legs**
67"Wx2"Dx28½"H, Shpg. Wt. 137 lbs.
- | | |
|---------------------|------------------------|
| LLR 81946‡ Latte | LIST PRICE |
| LLR 81919‡ Mahogany | \$270.00 ea |
- E. Single Middle Legs**
- | | |
|------------------------------------|------------------------|
| 25"Wx7½"Dx28½"H, Shpg. Wt. 44 lbs. | |
| LLR 81927 Latte | \$329.00 ea |
| LLR 81926 Mahogany | |
- F. Multiple Middle Legs**
- | | |
|-------------------------------------|------------------------|
| 43¾"Wx7½"Dx28½"H, Shpg. Wt. 66 lbs. | |
| LLR 81929 Latte | \$445.00 ea |
| LLR 81928 Mahogany | |
- G. Reverse Returns**
- | | |
|-----------------------------------|------------------------|
| 48"Wx24"Dx30"H, Shpg. Wt. 79 lbs. | |
| LLR 81942‡ Latte | \$265.00 ea |
| LLR 81941‡ Mahogany | |
- H. Bridges**
- | | |
|-----------------------------------|------------------------|
| 48"Wx24"Dx30"H, Shpg. Wt. 57 lbs. | |
| LLR 81944‡ Latte | \$211.00 ea |
| LLR 81943‡ Mahogany | |



Shown in Mahogany

CONCORDIA SERIES

Available January 2013.

I



I. File/File Pedestals
15¼"Wx22"Dx27¼"H, Shpg. Wt. 79 lbs.
LLR 81938‡ Latte
LLR 81937‡ Mahogany

LIST PRICE
~~\$284.00~~ ea

M



M. Low Storage Cabinets
47¼"Wx17¼"Dx16½"H, Shpg. Wt. 62 lbs.
LLR 81921 Latte
LLR 81920 Mahogany

LIST PRICE
~~\$205.00~~ ea

J



J. Box/Box/File Pedestals
15¼"Wx22"Dx27¼"H, Shpg. Wt. 83 lbs.
LLR 81940‡ Latte
LLR 81939‡ Mahogany

~~\$292.00~~ ea

N

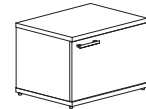

N. Low Storage Cabinet With Door
23"Wx17¼"Dx16½"H, Shpg. Wt. 46 lbs.
LLR 81924 Latte
LLR 81923 Mahogany

~~\$145.00~~ ea

K



K. 2-Drawer Lateral Files
36"Wx22"Dx30"H, Shpg. Wt. 172 lbs.
LLR 81936‡ Latte
LLR 81935‡ Mahogany

~~\$611.00~~ ea

O

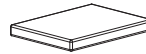

O. Cushions
23"Wx17¼"Dx2½"H, Shpg. Wt. 11 lbs.
LLR 81922 Black
LLR 81925 Gray

~~\$79.00~~ ea

L



L. Upper Desk Cabinets
Cabinets for 72" Desk,
16½"Wx17¼"Dx17¼"H, Shpg. Wt. 31 lbs.
LLR 81933‡ Latte
LLR 81932‡ Mahogany
Cabinets for 66" Desk,
16½"Wx16½"Dx17¼"H, Shpg. Wt. 26 lbs.
LLR 81931‡ Latte
LLR 81930‡ Mahogany

~~\$112.00~~ ea

~~\$107.00~~ ea

P

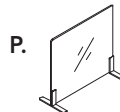

P. Upper Desk Partition
24"Wx2½"Dx12"H, Shpg. Wt. 12 lbs.
LLR 81947‡ Frost
35"Wx2½"Dx12"H, Shpg. Wt. 18 lbs.
LLR 81934 Frost

~~\$141.00~~ ea

~~\$172.00~~ ea

Q

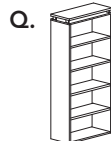

Q. 5-Shelf Bookcase
36"Wx12½"Dx68½"H, Shpg. Wt. 137 lbs.
LLR 68724‡ Latte
LLR 68722‡ Mahogany

~~\$418.00~~ ea

Assembly needed.
Please call for details.

‡ Cannot be shipped UPS.

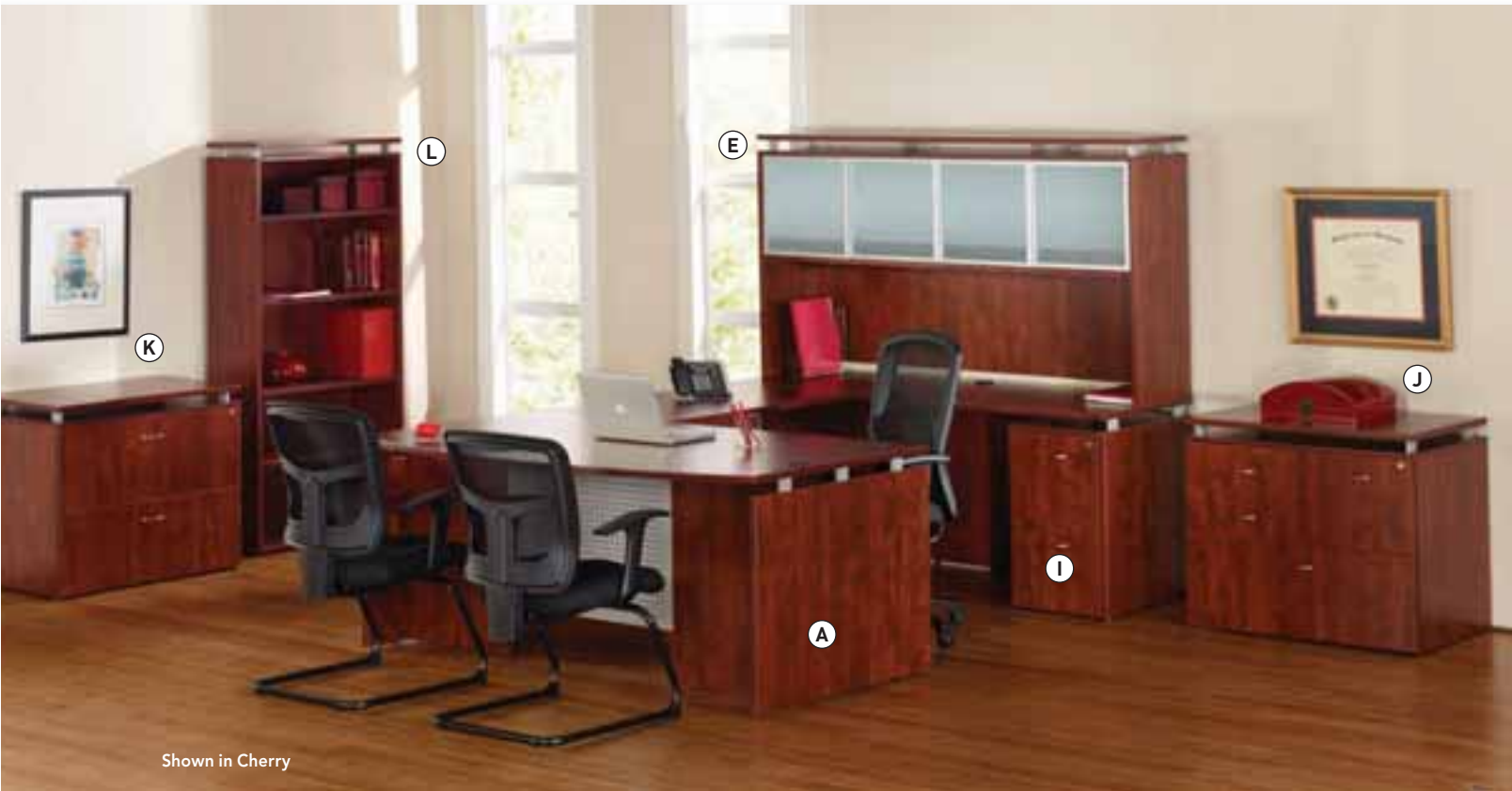





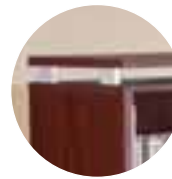

Shown in Cherry







LORELL ASCENT SERIES

- Contemporary style laminate desking with raised floating tops
- Modesty panels on desk are punched, powder-coated, Silver-Gray finish
- Hutches, pedestals and files ship assembled
- Wire management on corner desk, credenza, return and bridge
- Covered by Lorell Limited 5-Year Warranty

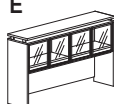

Edge Detail

A 	A. Bowfront Executive Desks  72"Wx36"Dx29½"H, Shpg. Wt. 159 lbs. LLR 68680‡ Mahogany LLR 68681‡ Cherry	LIST PRICE \$556.00 ea
B 	B. Rectangular Desks  72"Wx36"Dx29½"H, Shpg. Wt. 148 lbs. LLR 68682‡ Mahogany LLR 68683‡ Cherry	\$536.00 ea
C 	C. Corner Desks  66"Wx30"Dx29½"H, Shpg. Wt. 124 lbs. LLR 68684‡ Mahogany LLR 68685‡ Cherry	\$470.00 ea
	C. Corner Desks  60"Wx30"Dx29½"H, Shpg. Wt. 115 lbs. LLR 68686‡ Mahogany LLR 68687‡ Cherry	\$435.00 ea
	C. Corner Desks  36"Wx36"Dx29½"H, Shpg. Wt. 88 lbs. LLR 68694‡ Mahogany LLR 68695‡ Cherry	\$282.00 ea

D 	D. Credenzas  72"Wx24"Dx29½"H, Shpg. Wt. 110 lbs. LLR 68688‡ Mahogany LLR 68689‡ Cherry	LIST PRICE \$378.00 ea
	66"Wx24"Dx29½"H, Shpg. Wt. 106 lbs. LLR 68690‡ Mahogany LLR 68691‡ Cherry	\$370.00 ea
	60"Wx24"Dx29½"H, Shpg. Wt. 99 lbs. LLR 68692‡ Mahogany LLR 68693‡ Cherry	\$346.00 ea
E 	E. Hutches 72"Wx15"Dx39½"H, Shpg. Wt. 176 lbs. LLR 68708‡ Mahogany LLR 68709‡ Cherry	\$995.00 ea
	66"Wx15"Dx39½"H, Shpg. Wt. 168 lbs. LLR 68710‡ Mahogany LLR 68711‡ Cherry	\$990.00 ea
F  Front View	F. Returns  48"Wx24"Dx29½"H, Shpg. Wt. 79 lbs. LLR 68696‡ Mahogany LLR 68697‡ Cherry	\$251.00 ea
 Back View	42"Wx24"Dx29½"H, Shpg. Wt. 75 lbs. LLR 68698‡ Mahogany LLR 68699‡ Cherry	\$241.00 ea
	35"Wx24"Dx29½"H, Shpg. Wt. 70 lbs. LLR 68700‡ Mahogany LLR 68701‡ Cherry	\$235.00 ea



Shown in Cherry



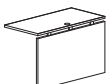
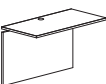

ASCENT SERIES

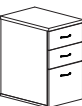

- G. Bridges** 
- | | | |
|---|--|------------------------|
| 
Front View | 48"Wx24"Dx29½"H, Shpg. Wt. 64 lbs. | LIST PRICE |
| | LLR 68702‡ Mahogany
LLR 68703‡ Cherry | \$214.00 ea |
| 
Back View | 42"Wx24"Dx29½"H, Shpg. Wt. 59 lbs. | LIST PRICE |
| | LLR 68704‡ Mahogany
LLR 68705‡ Cherry | \$191.00 ea |
| | 36"Wx24"Dx29½"H, Shpg. Wt. 55 lbs. | LIST PRICE |
| | LLR 68706‡ Mahogany
LLR 68707‡ Cherry | \$177.00 ea |



- J. 4-Drawer File**
- | | | |
|---|--|------------------------|
|  | 36"Wx22"Dx30"H, Shpg. Wt. 167 lbs. | LIST PRICE |
| | LLR 68716‡ Mahogany
LLR 68717‡ Cherry | \$660.00 ea |

- H. Box/Box/File Pedestals**
- | | | |
|---|--|------------------------|
|  | 15¾"Wx22"Dx27½"H, Shpg. Wt. 79 lbs. | LIST PRICE |
| | LLR 68714‡ Mahogany
LLR 68715‡ Cherry | \$265.00 ea |

- K. 2-Drawer File**
- | | | |
|---|--|------------------------|
|  | 36"Wx22"Dx30"H, Shpg. Wt. 150 lbs. | LIST PRICE |
| | LLR 68718‡ Mahogany
LLR 68719‡ Cherry | \$570.00 ea |

- I. File/File Pedestals**
- | | | |
|---|--|------------------------|
|  | 15¾"Wx22"Dx27½"H, Shpg. Wt. 75 lbs. | LIST PRICE |
| | LLR 68712‡ Mahogany
LLR 68713‡ Cherry | \$265.00 ea |

- L. 5-Shelf Bookcase** 
- | | | |
|---|--|------------------------|
|  | 36"Wx12½"Dx68¾"H, Shpg. Wt. 137 lbs. | LIST PRICE |
| | LLR 68722‡ Mahogany
LLR 68723‡ Cherry | \$418.00 ea |

- M. 4-Shelf Bookcase** 
- | | | |
|---|--|------------------------|
|  | 36"Wx12½"Dx48"H, Shpg. Wt. 106 lbs. | LIST PRICE |
| | LLR 68720‡ Mahogany
LLR 68721‡ Cherry | \$339.00 ea |

 Assembly needed. Please call for details. ‡Cannot be shipped UPS.



Creating what works for you.

Essential Series in virtually every configuration to fit perfectly in your workspace.

CONFIGURATION OPTIONS



Executive



U-Shape



L-Shape



Corner

PEDESTAL OPTIONS

Full Fixed Pedestal

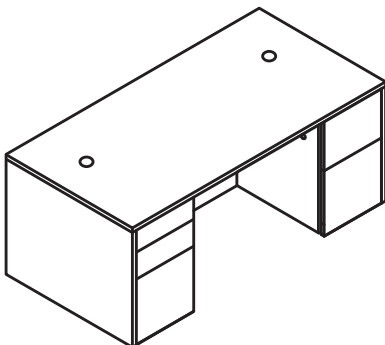

Mobile Pedestal

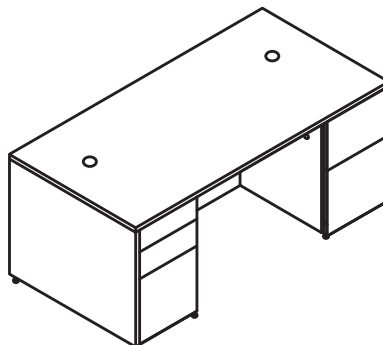

3/4 Fixed Pedestal

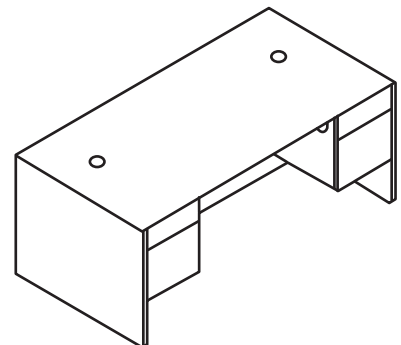

See page 10 for pedestal options.



LORELL

ESSENTIALS SERIES



- 1" thick laminate top
- Credenza has one grommet for easy cord routing
- Desks feature two grommet holes for easy cord routing
- Pedestals accommodate letter- and legal-size hanging files
- Bookcases feature four adjustable shelves and one fixed bottom shelf with adjustable feet
- Lateral File, Pedestal and Hutches ship fully assembled
- Hutches, Pedestals and Files ship assembled
- Covered by Lorell Limited 5-Year Warranty

Shown in Mahogany

Handle

Grommet

A

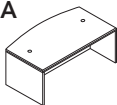

A. Bowfront Desk Shells

72"Wx36"Dx29½"H, Shpg. Wt. 157 lbs.
LLR 69370‡ Mahogany
LLR 69406‡ Cherry

LIST PRICE

\$325.00 ea

B

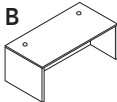

B. Rectangular Desk Shells

72"Wx36"Dx29½"H, Shpg. Wt. 148 lbs.
LLR 69371‡ Mahogany
LLR 69407‡ Cherry

\$320.00 ea

66"Wx30"Dx29½"H, Shpg. Wt. 124 lbs.
LLR 69372‡ Mahogany
LLR 69408‡ Cherry

\$265.00 ea

60"Wx30"Dx29½"H, Shpg. Wt. 115 lbs.
LLR 69373‡ Mahogany
LLR 69409‡ Cherry

\$260.00 ea

48"Wx30"Dx29½"H, Shpg. Wt. 101 lbs.
LLR 69902‡ Mahogany
LLR 69903‡ Cherry

\$233.00 ea

48"Wx24"Dx29½"H, Shpg. Wt. 88 lbs.
LLR 69375‡ Mahogany
LLR 69411‡ Cherry

\$210.00 ea

C

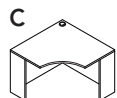

C. Corner Desk

42"Wx42"Dx24"Dx29½"H, Shpg. Wt. 97 lbs.
LLR 69918‡ Mahogany
LLR 69919‡ Cherry

\$242.00 ea

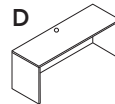

D. Credenza Shells

72"Wx24"Dx29½"H, Shpg. Wt. 110 lbs.
LLR 69376‡ Mahogany
LLR 69412‡ Cherry

LIST PRICE

\$268.00 ea

66"Wx24"Dx29½"H, Shpg. Wt. 99 lbs.
LLR 69377‡ Mahogany
LLR 69413‡ Cherry

\$236.00 ea

60"Wx24"Dx29½"H, Shpg. Wt. 95 lbs.
LLR 69378‡ Mahogany
LLR 69435‡ Cherry

\$220.00 ea

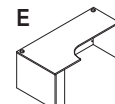

E. Left Corner Credenzas

72"Wx36"Dx24"Dx29½"H, Shpg. Wt. 144 lbs.
LLR 69906‡ Mahogany
LLR 69907‡ Cherry

\$310.00 ea

66"Wx36"Dx24"Dx29½"H, Shpg. Wt. 120 lbs.
LLR 69910‡ Mahogany
LLR 69911‡ Cherry

\$305.00 ea

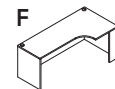

F. Right Corner Credenza

72"Wx36"Dx24"Dx29½"H, Shpg. Wt. 144 lbs.
LLR 69904‡ Mahogany
LLR 69905‡ Cherry

\$310.00 ea

66"Wx36"Dx24"Dx29½"H, Shpg. Wt. 120 lbs.
LLR 69908‡ Mahogany
LLR 69909‡ Cherry

\$305.00 ea

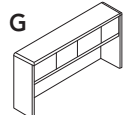

G. Hutch With Doors

72"Wx15"Dx36"H, Shpg. Wt. 172 lbs.
LLR 69382‡ Mahogany
LLR 69416‡ Cherry

\$480.00 ea

66"Wx15"Dx36"H, Shpg. Wt. 159 lbs.
LLR 69383‡ Mahogany
LLR 69417‡ Cherry

\$456.00 ea

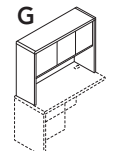

60"Wx15"Dx36"H, Shpg. Wt. 125 lbs.
LLR 69912‡ Mahogany
LLR 69913‡ Cherry

\$410.00 ea

48"Wx15"Dx36"H, Shpg. Wt. 110 lbs.
LLR 69384‡ Mahogany
LLR 69418‡ Cherry

\$403.00 ea







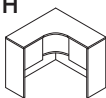

Assembly needed. Please call for details.

‡Cannot be shipped UPS.



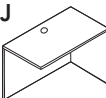





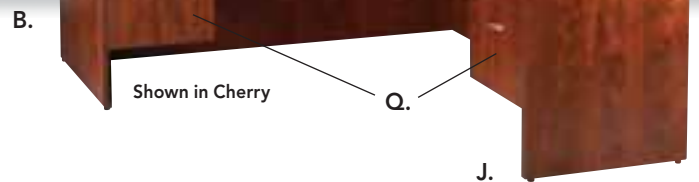

Shown in Mahogany
See page 31 for Chair LLR 86202

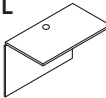
ESSENTIALS SERIES

	H. Corner Hutch  41"Wx41"Dx36"H, Shpg. Wt. 137 lbs. LLR 69920† Mahogany LLR 69915† Cherry	LIST PRICE \$359.00 ea
	I. Tackboards  For 72" Hutch 69"Wx34"Dx16½"H, Shpg. Wt. 20 lbs. LLR 69914† Black	\$45.00 ea
	For 66" Hutch 64½"Wx34"Dx16½"H, Shpg. Wt. 18 lbs. LLR 69915† Black	\$45.00 ea
	For 60" Hutch 56¾"Wx34"Dx16½"H, Shpg. Wt. 16 lbs. LLR 69916† Black	\$40.00 ea
	For 45" Hutch 45¾"Wx34"Dx16½"H, Shpg. Wt. 14 lbs. LLR 69917† Black	\$35.00 ea
	J. Return Shells  48"Wx24"Dx29½"H, Shpg. Wt. 82 lbs. LLR 69387† Mahogany LLR 69421† Cherry	\$190.00 ea
	42"Wx24"Dx29½"H, Shpg. Wt. 73 lbs. LLR 69388† Mahogany LLR 69422† Cherry	\$168.00 ea
	35"Wx24"Dx29½"H, Shpg. Wt. 66 lbs. LLR 69389† Mahogany LLR 69423† Cherry	\$151.00 ea
	K. Peninsulas  72"Wx36"Dx29½"H, Shpg. Wt. 101 lbs. LLR 69379† Mahogany, Box 1 of 2 LLR 69414† Cherry, Box 1 of 2	\$240.00 ea
	LLR 69381† Black Post, Box 2 of 2	\$82.00 ea
	66"Wx30"Dx29½"H, Shpg. Wt. 93 lbs. LLR 69380† Mahogany, Box 1 of 2 LLR 69415† Cherry, Box 1 of 2	\$200.00 ea
	LLR 69381† Black Post, Box 2 of 2	\$82.00 ea



Shown in Cherry

	L. Bridges  48"Wx24"Dx29½"H, Shpg. Wt. 66 lbs. LLR 69390† Mahogany LLR 69424† Cherry	LIST PRICE \$145.00 ea
	42"Wx24"Dx29½"H, Shpg. Wt. 57 lbs. LLR 69391† Mahogany LLR 69426† Cherry	\$137.00 ea
	M. Box/File Mobile Pedestals 16"Wx22"Dx28¼"H, Shpg. Wt. 80 lbs. LLR 69395† Mahogany LLR 69430† Cherry	\$295.00 ea
	N. File/File Mobile Pedestals 16"Wx22"Dx28¼"H, Shpg. Wt. 84 lbs. LLR 69397† Mahogany LLR 69431† Cherry	\$270.00 ea
	O. Box/File Fixed Pedestals NEW! 16"Wx22"Dx28¼"H, Shpg. Wt. 80 lbs. LLR 69603† Mahogany LLR 69604† Cherry	\$280.00 ea
	P. File/File Fixed Pedestals NEW! 16"Wx22"Dx28¼"H, Shpg. Wt. 84 lbs. LLR 69605† Mahogany LLR 69606† Cherry	\$260.00 ea
	Q. Box/File Hanging Pedestals 16"Wx22"Dx21"H, Shpg. Wt. 60 lbs. LLR 69398† Mahogany LLR 69432† Cherry	\$199.00 ea
	R. Computer Workstations 41¾"Wx23¾"Dx29½"H, Shpg. Wt. 45 lbs. LLR 48085† Mahogany LLR 48086† Cherry	\$259.00 ea



Shown in Mahogany



Shown in Cherry



ESSENTIALS SERIES

S



S. Lateral Files

Features central locking system and anti-tip so only one drawer can be opened at a time. Finished top.

35"Wx22"Dx29½"H, Shpg. Wt. 150 lbs.
 LLR 69399‡ Mahogany
 LLR 69433‡ Cherry

LIST PRICE

~~\$420.00~~ ea

T

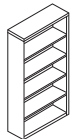

T. 5-Shelf Bookcases

36"Wx12½"Dx72"H, Shpg. Wt. 84 lbs.
 LLR 69494‡ Mahogany
 LLR 69495‡ Cherry

~~\$349.00~~ ea

U

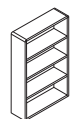

U. 4-Shelf Bookcases

36"Wx12½"Dx48"H, Shpg. Wt. 60 lbs.
 LLR 69498‡ Mahogany
 LLR 69499‡ Cherry

~~\$259.00~~ ea

V



V. Oval Conference Tables

72"Wx36"Dx29½"H, Shpg. Wt. 110 lbs.
 LLR 87272‡ Top & Base, Mahogany
 LLR 87373‡ Top & Base, Cherry

~~\$330.00~~ ea

X.



Shown in Cherry

W



W. Round Tops

48"W Diameter, Shpg. Wt. 55 lbs.
 LLR 87240‡ Top, Mahogany
 LLR 87321‡ Top, Cherry

LIST PRICE

~~\$190.00~~ ea

42"W Diameter, Shpg. Wt. 49 lbs.
 LLR 87239‡ Top, Mahogany
 LLR 87322‡ Top, Cherry

~~\$155.00~~ ea

X



X. Laminate Bases For 42" & 48" Tops

24"Wx24"Dx29"H, Shpg. Wt. 55 lbs.
 LLR 69401 Mahogany Laminate Base
 LLR 69436 Cherry Laminate Base

~~\$115.00~~ ea

Y

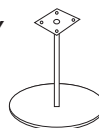

Y. Metal Base For 42" & 48" Tops

24"Wx24"Dx29"H, Shpg. Wt. 82 lbs.
 LLR 87241‡ Black Steel Base

~~\$280.00~~ ea

Assembly needed. Please call for details.

‡ Cannot be shipped UPS.

LAMINATE COMPUTER WORKSTATIONS





Shown in Mahogany
Essentials Series Furniture shown on pages 9-13

LORELL[®] ESSENTIALS SERIES

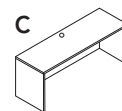

- 1" thick laminate top
- Credenza has one grommet for easy cord routing
- Pedestals accommodate letter- and legal-size hanging files
- Pedestal and Hutch come fully assembled
- Covered by Lorell Limited 5-Year Warranty



C. Credenza Shells 
66"Wx24"Dx29½"H, Shpg. Wt. 99 lbs.
LLR 69377‡ Mahogany
LLR 69413‡ Cherry

LIST PRICE
\$236.00 ea

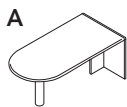

A. Peninsulas 

Must order both boxes.

66"Wx30"Dx29½"H, Shpg. Wt. 93 lbs. LIST PRICE
LLR 69380‡ Mahogany, Box 1 of 2 **\$200.00 ea**
LLR 69415‡ Cherry, Box 1 of 2

LLR 69381‡ Black Post, Box 2 of 2 **\$82.00 ea**

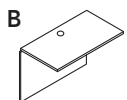

B. Bridges 

Features one grommet on top and one on back panel for easy cord routing.

42"Wx24"Dx29½"H, Shpg. Wt. 57 lbs.
LLR 69391‡ Mahogany **\$145.00 ea**
LLR 69426‡ Cherry

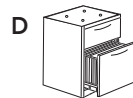

D. 3/4 Box/File Hanging Pedestals

16"Wx22"Dx28¼"H, Shpg. Wt. 60 lbs.
LLR 69398‡ Mahogany **\$199.00 ea**
LLR 69432‡ Cherry

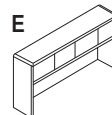

E. Hutch With Doors

66"Wx36"Dx15"H, Shpg. Wt. 159 lbs.
LLR 69383‡ Mahogany **\$456.00 ea**
LLR 69417‡ Cherry



Modular Workstation Shown in Cherry



A.

B.

Mahogany

ESSENTIALS SERIES

A. Desk Shells

48"Wx30"Dx29½"H, Shpg. Wt. 101 lbs.
LLR 69902‡ Mahogany
LLR 69903‡ Cherry

LIST PRICE
\$233.00 ea

B. Box/File Hanging Pedestals

16"Wx22"Dx28¼"H, Shpg. Wt. 60 lbs.
LLR 69398‡ Mahogany
LLR 69432‡ Cherry

\$199.00 ea



C. Computer Workstations

Four casters, two locking. Two wire grommets on top, one in back panel for cord management. Pull-out shelf and internal shelf for additional storage. Covered by Lorell Limited 5-Year Warranty.

41½"Wx23¾"Dx29½"H, Shpg. Wt. 45 lbs.
LLR 48085‡ Mahogany
LLR 48086‡ Cherry

LIST PRICE
\$259.00 ea



Cherry

NEW!



C.

Mahogany

Assembly needed. Please call for details.

‡Cannot be shipped UPS.



LORELL
67000 SERIES



- Steel construction with powder coated textured finish; durable laminate tops feature radius edges
- Drawers and flipper doors glide on steel ball-bearings
- Two knock-outs in each leg for cable connections between desks
- Open Shelves include wire channeling to desktop
- Contains 50% recycled content and 30% post-consumer material
- Covered by Lorell Limited 5-Year Warranty



Wire Management



Grommets

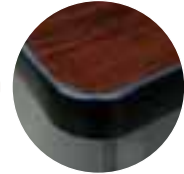

Radius Corners

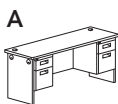

A. Double Pedestal Desks With Grommets
72"Wx36"Dx29"H, Shpg. Wt. 258 lbs. LIST PRICE
LLR 67151‡ Cherry/Charcoal \$1288.00 ea
LLR 67152‡ Mahogany/Charcoal
60"Wx30"Dx29"H, Shpg. Wt. 205 lbs.
LLR 67251‡ Cherry/Charcoal \$1166.00 ea
LLR 67252‡ Mahogany/Charcoal

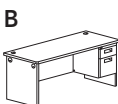

B. Single Pedestal Desks With Grommets
72"Wx36"Dx29"H, Shpg. Wt. 201 lbs.
LLR 67253‡ Cherry/Charcoal \$926.00 ea
LLR 67254‡ Mahogany/Charcoal
66"Wx30"Dx29"H, Shpg. Wt. 178 lbs.
LLR 67176‡ Cherry/Charcoal \$1089.00 ea
LLR 67177‡ Mahogany/Charcoal
60"Wx30"Dx29"H, Shpg. Wt. 165 lbs.
LLR 67781‡ Cherry/Charcoal \$1037.00 ea
LLR 67782‡ Mahogany/Charcoal

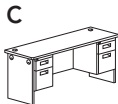

48"Wx30"Dx29"H, Shpg. Wt. 140 lbs.
LLR 67276‡ Cherry/Charcoal \$964.00 ea
LLR 67277‡ Mahogany/Charcoal

C. Double Pedestal Credenzas With Grommets
72"Wx24"Dx29"H, Shpg. Wt. 175 lbs.
LLR 67351‡ Cherry/Charcoal \$1152.00 ea
LLR 67352‡ Mahogany/Charcoal



60"Wx24"Dx29"H, Shpg. Wt. 163 lbs.
LLR 67376‡ Cherry/Charcoal \$1106.00 ea
LLR 67377‡ Mahogany/Charcoal

D. Single Pedestal Credenzas With Grommets
72"Wx24"Dx29"H, Shpg. Wt. 158 lbs.
LLR 67380‡ Cherry/Charcoal \$980.00 ea
LLR 67381‡ Mahogany/Charcoal



E. Left Pedestal Returns
48"Wx24"Dx29"H, Shpg. Wt. 71 lbs.
LLR 67976‡ Cherry/Charcoal \$714.00 ea
LLR 67977‡ Mahogany/Charcoal

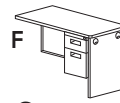

F. Right Pedestal Returns
48"Wx24"Dx29"H, Shpg. Wt. 71 lbs. LIST PRICE
LLR 67978‡ Cherry/Charcoal \$714.00 ea
LLR 67979‡ Mahogany/Charcoal

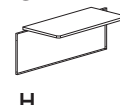

G. Desk Bridges
48"Wx24"D, Shpg. Wt. 65 lbs.
LLR 67476‡ Cherry/Charcoal \$395.00 ea
LLR 67477‡ Mahogany/Charcoal

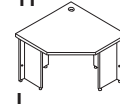

42"Wx24"D, Shpg. Wt. 57 lbs.
LLR 67551‡ Cherry/Charcoal \$375.00 ea
LLR 67552‡ Mahogany/Charcoal

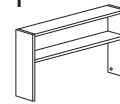

H. Corner Desks
42"Wx24"Dx29"H, Shpg. Wt. 90 lbs.
LLR 67576‡ Cherry/Charcoal \$931.00 ea
LLR 67577‡ Mahogany/Charcoal

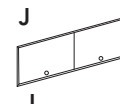

I. Open Shelves
72"Wx24"Dx36"H, Shpg. Wt. 86 lbs. LIST PRICE
LLR 67651‡ Charcoal \$621.00 ea

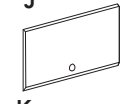

60"Wx24"Dx36"H, Shpg. Wt. 78 lbs. LIST PRICE
LLR 67676‡ Charcoal \$539.00 ea

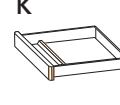

48"Wx24"Dx36"H, Shpg. Wt. 67 lbs. LIST PRICE
LLR 67751‡ Charcoal \$497.00 ea

J. Lockable Flipper Doors
2 Doors @ 72"Wx24"D, Shpg. Wt. 36 lbs. LIST PRICE
LLR 67776 Charcoal \$347.00 pr

2 Doors @ 60"Wx24"D, Shpg. Wt. 30 lbs. LIST PRICE
LLR 67851 Charcoal \$327.00 pr

1 Door @ 48"Wx24"D, Shpg. Wt. 24 lbs. LIST PRICE
LLR 67876 Charcoal \$199.00 ea

K. Center Drawers
25"Wx19"D LIST PRICE
LLR 67771 Charcoal \$159.00 ea
19"Wx19"D, Shpg. Wt. LIST PRICE
LLR 67778 Charcoal \$146.00 ea



FORTRESS SERIES

NEW!

Teacher's Desks

- Laminated wood top surface with rounded corners and vinyl covered edge
- Heavy-duty steel frame with powder coat finish
- Contains 50% recycled content and 50% post-consumer material
- Full extension steel ball bearing
- Central Locking System for drawers
- Covered by Lorell Limited Lifetime Warranty

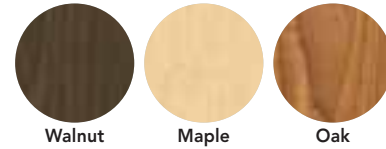

Walnut

Maple

Oak



Black/Oak

A.



Black/Oak

B.



Black/Maple



Black/Maple



Putty/Oak



Putty/Oak

A. Double Pedestal Teacher's Desk

60"Wx30"Dx29½"H, Shpg. Wt. 225 lbs.
 LLR 41299‡ Black/Oak
 LLR 41300‡ Black/Walnut
 LLR 41301‡ Black/Maple
 LLR 41302‡ Putty/Oak

LIST PRICE

\$977.00 ea

B. Single Pedestal Teacher's Desk

48"Wx30"Dx29½"H, Shpg. Wt. 145 lbs.
 LLR 41295‡ Black/Oak
 LLR 41296‡ Black/Walnut
 LLR 41297‡ Black/Maple
 LLR 41298‡ Putty/Oak

LIST PRICE

\$767.00 ea

NEW!

C. Fortress Series Bookcases

Fully adjustable shelves adjust on 1" center. 200 lb. shelf capacity. Meets or exceeds ANSI/BIFMA shelf standards. Welded steel construction. Powder coat finish. Covered by Lorell Limited Lifetime Warranty. **Ships fully assembled.**

See page 20 for more options.

5-Shelf

34½"Wx13"Dx72"H, Shpg. Wt. 63 lbs. LIST PRICE
 LLR 41291‡ Black
 LLR 41290‡ Putty **\$339.00 ea**

C.



D. Fortress Series Storage Cabinets

NEW!

180 lb. capacity per shelf, evenly distributed. Contemporary three-point recessed locking handle with keys. Three sets of hinges per door. Welded steel construction. Powder coat finish. Meets or exceeds ANSI/BIFMA standards. Covered by Lorell Limited Lifetime Warranty. **Ships fully assembled.**

See page 52 for more options.

72"H Cabinets

36"Wx18"Dx72"H, Shpg. Wt. 131 lbs. LIST PRICE
 LLR 41307‡ Putty **\$574.00 ea**

D.

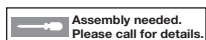

‡Cannot be shipped UPS.

LAMINATE CONFERENCE TABLES



ESSENTIALS SERIES CONFERENCE TABLES



- Conference Tables are 29½"H with adjustable floor glides on a two-panel leg base
- Two-piece top includes hardware for assembly
- 3.0 mil thick edge
- Covered by Lorell Limited 5-Year Warranty
- **96" tops and bases sold separately, must order both**



A.

Shown in Mahogany

A. Oval Conference Tables

Bases are 28" H, Shpg. Wt. 71 lbs.
Tops are 96"Wx48"D, Shpg. Wt. 139 lbs.

		LIST PRICE
LLR 69122‡	Top, Cherry	\$370.00 ea
LLR 69121‡	Base w/Modesty Panel, Cherry	\$220.00 ea
LLR 69150‡	Top, Mahogany	\$370.00 ea
LLR 69151‡	Base w/Modesty Panel, Mahogany	\$220.00 ea
72"Wx36"D, Shpg. Wt. 110 lbs.		
LLR 87373‡	Top & Base, Cherry	\$330.00 ea
LLR 87272‡	Top & Base, Mahogany	\$330.00 ea



B.

Shown in Cherry

B. Boat-Shaped Conference Tables

Tops are 96"Wx48"D, Shpg. Wt. 137 lbs.
Bases are 28" H, Shpg. Wt. 71 lbs.

		LIST PRICE			LIST PRICE
LLR 69120‡	Top, Cherry	\$370.00 ea	LLR 69149‡	Top, Mahogany	\$370.00 ea
LLR 69121‡	Base w/Modesty Panel, Cherry	\$220.00 ea	LLR 69151‡	Base w/Modesty Panel, Mahogany	\$220.00 ea

ESSENTIALS SERIES

A.



A. Rectangular Conference Tables

Tops and Base sold separately.

Tops are 96" W x 48" D, Shpg. Wt. 142 lbs.
Bases are 28" H, Shpg. Wt. 71 lbs.

		LIST PRICE
LLR 69123‡	Top, Cherry	\$370.00 ea
LLR 69121‡	Base w/Modesty Panel, Cherry	\$220.00 ea
LLR 69148‡	Top, Mahogany	\$370.00 ea
LLR 69151‡	Base w/Modesty Panel, Mahogany	\$220.00 ea

B.



Cherry

B. Round Conference Tables

Tops and Base sold separately.

48" Diameter, Shpg. Wt. 55 lbs.

		LIST PRICE
LLR 87321‡	Top, Cherry	\$190.00 ea
LLR 69436	Cherry Laminate Base	\$115.00 ea
LLR 87240‡	Top, Mahogany	\$190.00 ea
LLR 69401	Mahogany Laminate Base	\$115.00 ea

42" Diameter, Shpg. Wt. 49 lbs.

LLR 87322‡	Top, Cherry	\$155.00 ea
LLR 69436	Cherry Laminate Base	\$115.00 ea
LLR 87239‡	Top, Mahogany	\$155.00 ea
LLR 69401	Mahogany Laminate Base	\$115.00 ea

Steel Bases For 42" & 48" Tops
24" W x 24" D x 29" H, Shpg. Wt. 82 lbs.

LLR 87241‡	Black Steel Base	\$280.00 ea
------------	------------------	------------------------



Mahogany with
Black Steel Base

Assembly needed.
Please call for details.

‡ Cannot be shipped UPS.

WOOD VENEER BOOKCASES



VENEER BOOKCASES

- High-quality veneer bookcases
- Solid 3/4" thick shelves are adjustable on 1 3/4" centers with pin-hole attachments
- Bookcases have laminated matching grain-colored backs on interior and unfinished back side
- Covered by Lorell Limited 5-Year Warranty



Edge Detail



Mahogany



Cherry



Mahogany



Cherry

A. Radius Hardwood Veneer Bookcases

Soft radius corners are made from solid hardwood.

6-Shelf

36"Wx12"Dx84"H, Shpg. Wt. 124 lbs.
LLR 60080‡
LLR 85054‡

Mahogany
Cherry

LIST PRICE
\$510.00 ea

6-Shelf

36"Wx12"Dx72"H, Shpg. Wt. 105 lbs.
LLR 60079‡
LLR 85053‡

Mahogany
Cherry

\$495.00 ea

5-Shelf

36"Wx12"Dx60"H, Shpg. Wt. 89 lbs.
LLR 60078‡
LLR 85052‡

Mahogany
Cherry

\$390.00 ea

4-Shelf

36"Wx12"Dx48"H, Shpg. Wt. 73 lbs.
LLR 60077‡
LLR 85051‡

Mahogany
Cherry

\$345.00 ea

3-Shelf

36"Wx12"Dx36"H, Shpg. Wt. 56 lbs.
LLR 60076‡
LLR 85050‡

Mahogany
Cherry

\$250.00 ea



VENEER BOOKCASES

- High-quality veneer bookcases
- Solid 3/4" thick shelves are adjustable on 1 1/4" centers with pin-hole attachments
- Bookcases have laminated matching grain-colored backs on interior and unfinished back side
- Covered by Lorell Limited 5-Year Warranty



Mahogany

Cherry



Cherry

Mahogany

A. Panel End Hardwood Veneer Bookcases

6-Shelf

36"Wx12"Dx84"H, Shpg. Wt. 124 lbs.
 LLR 60075‡ Mahogany
 LLR 89055‡ Cherry

LIST PRICE

\$510.00 ea

6-Shelf

36"Wx12"Dx72"H, Shpg. Wt. 105 lbs.
 LLR 60074‡ Mahogany
 LLR 89054‡ Cherry

\$495.00 ea

5-Shelf

36"Wx12"Dx60"H, Shpg. Wt. 89 lbs.
 LLR 60073‡ Mahogany
 LLR 89053‡ Cherry

\$340.00 ea

4-Shelf

36"Wx12"Dx48"H, Shpg. Wt. 73 lbs.
 LLR 60072‡ Mahogany
 LLR 89052‡ Cherry

LIST PRICE

\$290.00 ea

3-Shelf

36"Wx12"Dx36"H, Shpg. Wt. 56 lbs.
 LLR 60071‡ Mahogany
 LLR 89051‡ Cherry

\$220.00 ea

2-Shelf

36"Wx12"Dx30"H, Shpg. Wt. 52 lbs.
 LLR 60070‡ Mahogany
 LLR 89050‡ Cherry

\$200.00 ea

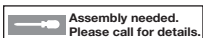

‡ Cannot be shipped UPS.

METAL BOOKCASES

A.



6-Shelf, Black



5-Shelf, Light Gray



4-Shelf, Putty



3-Shelf, Black



2-Shelf, Light Gray



FORTRESS SERIES

A. Metal Bookcases

Fully adjustable shelves adjust on 1" center. Welded steel construction. Powder coat finish. Ships assembled. Covered by Lorell Limited Lifetime warranty.

6-Shelf

34½"Wx13"Dx82"H, Shpg. Wt. 91 lbs.
 LLR 41294‡ Black
 LLR 41293‡ Putty
 LLR 41292‡ Light Gray

LIST PRICE

\$399.00 ea

5-Shelf

34½"Wx13"Dx72"H, Shpg. Wt. 63 lbs.
 LLR 41291‡ Black
 LLR 41290‡ Putty
 LLR 41289‡ Light Gray

\$339.00 ea

4-Shelf

34½"Wx13"Dx60"H, Shpg. Wt. 56 lbs.
 LLR 41288‡ Black
 LLR 41287‡ Putty
 LLR 41286‡ Light Gray

\$299.00 ea

3-Shelf

34½"Wx13"Dx42"H, Shpg. Wt. 43 lbs.
 LLR 41285‡ Black
 LLR 41284‡ Putty
 LLR 41283‡ Light Gray

LIST PRICE

\$244.00 ea

2-Shelf

34½"Wx13"Dx30"H, Shpg. Wt. 34 lbs.
 LLR 41282‡ Black
 LLR 41281‡ Putty
 LLR 41280‡ Light Gray

\$179.00 ea



COMPUTER WORKSTATIONS

- Laminate worksurfaces
- Metal to Metal screw fasteners
- Fits small office/home office applications
- Covered by Lorell Limited 5-Year Warranty

A. Laminate Computer Desk

Powder-coated metal legs. Pull-out keyboard shelf. Four adjustable glides on leg structure. Metal-to-metal screw fasteners. 250 lb. capacity. Comes with CPU holder.

31½"Wx19½"Dx29½"H,
Shpg. Wt. 141 lbs.
LLR 84845‡

Black/Silver

LIST PRICE
~~\$125.00~~ ea



NEW!

B.



NEW!

B. Computer Desk

Square tube leg computer desk. Top is 18 mm thick and storage areas are 15 mm. MDF board with PVC edge band. Powder coated silver steel frame. Black laminate. Two small storage areas, one left and one right of sitting area. Adjustable leveling glides. Full assembly instructions. Metal to metal screw fasteners. Amount of weight that can be loaded to worksurface 250 lbs., must be evenly distributed.

47¼"Wx21½"Dx29¼"H,
Shpg. Wt. 52 lbs.
LLR 84842‡

Black/Silver

LIST PRICE
~~\$199.00~~ ea



NEW!

C.

C. Computer Desk

MDF laminated top and powder coated metal legs. 18 mm thick top. Comes with pull-out keyboard shelf with 15 mm thick surface. Keyboard shelf to semi-lock into place to prevent complete pull-out during use. Four adjustable glides on leg structure. Full assembly instructions. Metal to metal screw fasteners. Leg is 25 mmx25 mm tube. Comes with holder for CPU. Amount of weight that can be loaded to worksurface 250 lbs., must be evenly distributed.

45¼"Wx20½"Dx35½"H,
Shpg. Wt. 34 lbs.
LLR 84847‡

Black/Silver

LIST PRICE
~~\$139.00~~ ea

D.



NEW!

D. Mobile Laptop Caddy

Powder coated steel frame. Adjustable, 15mm thick top. Four dual wheel casters, four locking. Tilting laptop surface with paper/computer stop to ensure product does not slide off when in forward most position. Covered by Lorell Limited 5-Year Warranty.

29½"Wx20"Dx27"-38"H,
Shpg. Wt. 23 lbs.
LLR 84843

Black/Silver

LIST PRICE
~~\$105.00~~ ea

Assembly needed. Please call for details.

‡Cannot be shipped UPS.

TRAINING ROOM



Shown in Cherry

A.



Mahogany



Shown in Cherry

LORELL SHIFT SERIES

- Versatile and economical tables for the training or conference room
- Tops are vacuum-formed PVC
- Tops flip back with a simple lever mechanism and nest together for space-saving storage
- Frames are black powder-coated steel
- Each table rolls easily on two 2" casters
- TAA compliant
- Covered by Lorell Limited 5-Year Warranty
- **Top and base in one carton**

A. 72" Flipper Table

72"Wx24"Dx29½"H, Shpg. Wt. 80 lbs.
LLR 60667‡ Cherry
LLR 60670‡ Mahogany
LLR 60673‡ Light Gray

LIST PRICE

\$512.00 ea

B. 60" Flipper Table

60"Wx24"Dx29½"H, Shpg. Wt. 65 lbs.
LLR 60666‡ Cherry
LLR 60669‡ Mahogany
LLR 60672‡ Light Gray

\$450.00 ea

C. ½ Round Flipper Table

48"W x 24"D x 29½"H, Shpg. Wt. 50 lbs.
LLR 60665 Cherry
LLR 60668 Mahogany
LLR 60671 Light Gray

\$358.00 ea



Light Gray



D. Stackable Guest Chair With Arms

Covered by Lorell Limited 5-Year Warranty.

Two per carton.

LIST PRICE

23½"Wx23½"Dx33"H, Shpg. Wt. 25 lbs.
LLR 65965‡ Black \$410.00 ct



Shown in Cherry

INVENT

Training Tables

- Tables feature 1¼" laminate tops with durable, vinyl T-Mold edges
- Optional ganging connector (LLR 60687) secures tables together quickly and detaches for easy reconfiguration
- Tops and bases ordered separately
- Covered by Lorell Limited 5-Year Warranty

A. 72"W Rectangular Table Tops (No Grommets)

72"Wx24"D		LIST PRICE
LLR 60680	Cherry	
LLR 60681	Mahogany	
LLR 60682	Light Gray	\$327.00 ea

60"W Rectangular Table Tops (No Grommets)

60"Wx24"D		
LLR 60677	Cherry	
LLR 60678	Mahogany	
LLR 60679	Light Gray	\$290.00 ea

48"W Rectangular Table Tops (No Grommets)

48"Wx24"D		
LLR 60674	Cherry	
LLR 60675	Mahogany	
LLR 60676	Light Gray	\$237.00 ea



B. Modesty Panels

- Perforated steel modesty panels mount directly onto table top
- Oversized wire channel allows wires to pass through the bottom of panel

		LIST PRICE
For 72" Tables, 66"Wx3"Dx10"H		
LLR 60686‡	Black	\$264.00 ea
For 60" Tables, 54"Wx3"Dx10"H		
LLR 60685	Black	\$244.00 ea
For 48" Tables, 42"Wx3"Dx10"H		
LLR 60684	Black	\$220.00 ea

C. C-Leg Table Base

For all rectangular top sizes shown above.
14-gauge tubular steel C-leg base (pair). Black.

1½"Wx22"Dx27"H		LIST PRICE
With 2" Casters		\$157.00 ct
LLR 60683		
With Glides		\$157.00 pr
LLR 60649		

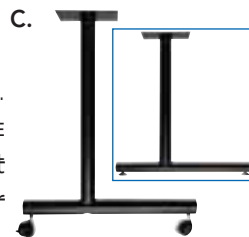

D. Quick Align Table Connector

Heavy-duty metal plate with plastic knobs. Designed specifically for frequent table reconfigurations.

LLR 60687	Black	LIST PRICE
		\$54.00 ea



E.

E. Guest Chairs

Breathable mesh woven back with faux leather seat. Designed for medium use and rated up to 250 lbs. Covered by Lorell Limited 5-Year Warranty.

24"Wx23½"Dx32¾"H		LIST PRICE
LLR 60462	Black Faux Leather Seat	\$252.00 ea



Black Faux Leather Seat

G. Multi-Task Chair

Fabric back and seat cushion. Five-star nylon base with dual wheel casters. 225 lb. capacity. Covered by Lorell Limited 5-Year Warranty.

24"Wx33"Dx24"H		LIST PRICE
LLR 84863	Black	\$128.00 ea



NEW!

*For a complete listing of chair features, see page 29

Assembly needed. Please call for details. ‡Cannot be shipped UPS.



Hospitality Tables

- 1/4" laminate top with durable vinyl T-Mold edge
- Tops and bases ordered separately
- Covered by Lorell Limited 5-Year Warranty.

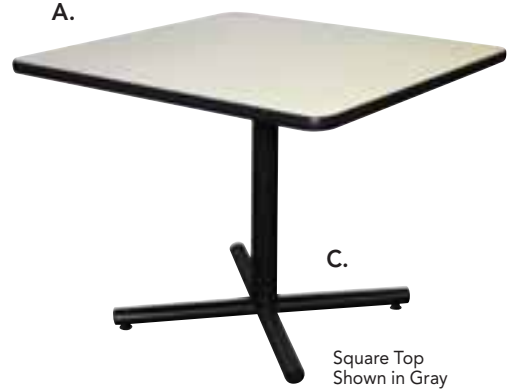

A. Square Table Tops

42"Wx42"Dx1 1/4"H		LIST PRICE
LLR 60697	Cherry	
LLR 60698	Mahogany	
LLR 61695	Light Gray	\$294.00 ea
<hr/>		
36"Wx36"Dx1 1/4"H		
LLR 60694	Cherry	
LLR 60695	Mahogany	
LLR 60696	Light Gray	\$284.00 ea

B. Round Table Tops

42" Diameter		LIST PRICE
LLR 60691	Cherry	
LLR 60692	Mahogany	
LLR 60693	Light Gray	\$294.00 ea
<hr/>		
36" Diameter		
LLR 60688	Cherry	
LLR 60689	Mahogany	
LLR 60690	Light Gray	\$284.00 ea

C. X-Leg Table Base

For round or square tables. 14-gauge tubular steel. Welded construction. Connecting hardware included. Tops and bases ordered separately. Covered by Lorell Limited 5-Year Warranty.

		LIST PRICE
42" Base		
LLR 61697	Black	\$197.00 ea
<hr/>		
36" Base		
LLR 61696	Black	\$190.00 ea



A. Upholstered Stack Chairs

Seat is 1 1/2" thick. Rugged 7/8" tubular steel black frame. Can stack up to eight high. Covered by Lorell Limited 5-Year Warranty. Weight Capacity: 250 lbs. max. **Four per carton.**

	LIST PRICE
18"Wx22"Dx35 1/2"H, Shpg. Wt. 53 lbs. LLR 62514‡ Blueberry/Black Fabric With Charcoal Frame	\$347.00 ct



E. Guest Chair

Guest chair with plastic back and chrome finish legs. Padded mesh seat. Covered by Lorell Limited 5-Year Warranty.

Two per carton.

	LIST PRICE
26"Wx25"Dx39"H, Shpg. Wt. 60 lbs. LLR 52122‡ Black	\$670.00 ct



- Hospitality folding tables with plastic or laminate tops
- Platinum and Mahogany finishes available
- Covered by Lorell Limited 5-Year Warranty

A. Ultra-Lite Folding Tables

Lighter than standard solid core for easier portability. The 1" beveled radius edge top is constructed of blow-molded, high-density polyethylene. Legs are heavy-duty 1" round powder-coated steel to resist rust. The metal support brackets are riveted to the support rails to create a strong frame. Can be used indoors or out. Holds up to 600 lbs. evenly distributed. Covered by Lorell Limited 5-Year Warranty.

96"Wx30"Dx29"H, Shpg. Wt. 49 lbs.
LLR 12346‡ Platinum
72"Wx30"Dx29"H, Shpg. Wt. 43 lbs.
LLR 12345‡ Platinum

LIST PRICE
\$310.00 ea
\$245.00 ea



Platinum



B.

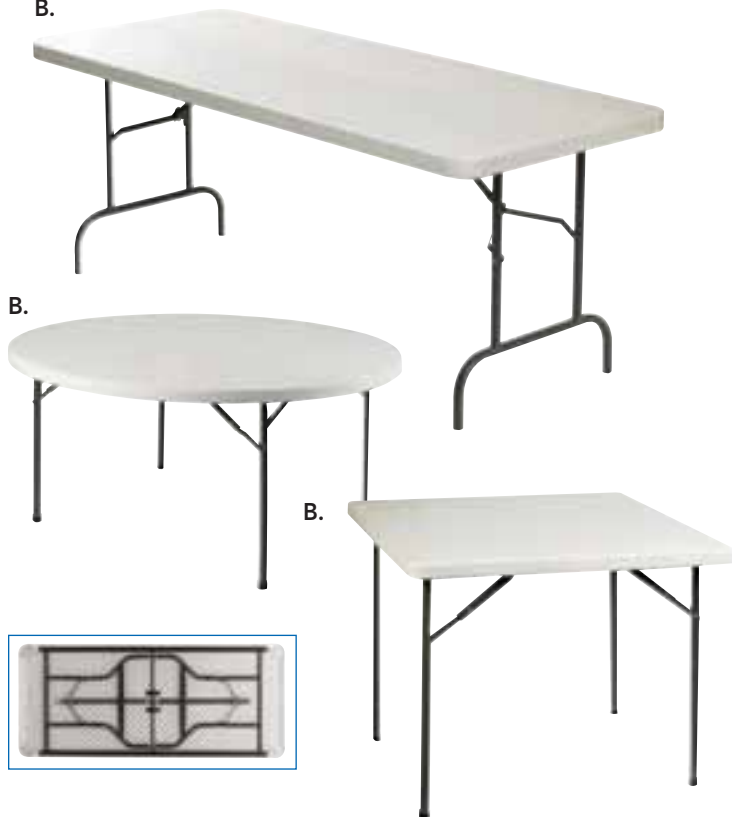

B.

B.

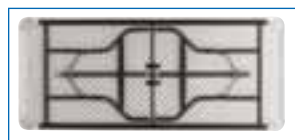

B. Ultra-Lite Banquet Tables

For light duty use, 96", 72", 60" tables hold up to 500 lbs. evenly distributed. 48" table holds 250 lbs. evenly distributed. The 2" thick square-edge top is constructed of blow-molded, high-density polyethylene. Powder coated 1" round steel legs. Center support tube supports frame. Can be used indoors or out. Covered by Lorell Limited 5-Year Warranty.

Rectangular Tables ♻️

Contains 35% recycled material.

96"Wx30"Dx29"H, Shpg. Wt. 49 lbs.
LLR 66650‡ Platinum
72"Wx30"Dx29"H, Shpg. Wt. 36 lbs.
LLR 66651‡ Platinum
60"Wx30"Dx29"H, Shpg. Wt. 31 lbs.
LLR 66652‡ Platinum
48"Wx24"Dx29"H, Shpg. Wt. 25 lbs.
LLR 66653 Platinum

LIST PRICE
\$242.00 ea
\$166.00 ea
\$156.00 ea
\$150.00 ea

Round Tables

71"Wx71"Dx29¼"H, Shpg. Wt. 45 lbs.
LLR 60325‡ Platinum
60"Wx60"Dx29¼"H, Shpg. Wt. 40 lbs.
LLR 60326‡ Platinum
48"Wx48"Dx29¼"H, Shpg. Wt. 38 lbs.
LLR 60327‡ Platinum

\$402.00 ea
\$285.00 ea
\$200.00 ea

Square Table

36"Wx36"Dx29"H, Shpg. Wt. 22 lbs.
LLR 60328‡ Platinum

\$139.00 ea

C. Economy Folding Tables

Wear-resistant 5/8" thick melamine top. Melamine sealed underside to prevent moisture absorption. Steel skirt support with plastic corners to protect surface when stacking. 1" diameter steel legs with protective foot cap. Covered by Lorell Limited 5-Year Warranty.

96"Wx30"Dx29"H, Shpg. Wt. 66 lbs.
LLR 65761‡ Mahogany
72"Wx30"Dx29"H, Shpg. Wt. 57 lbs.
LLR 65757‡ Mahogany
60"Wx30"Dx29"H, Shpg. Wt. 48.5 lbs.
LLR 65755‡ Mahogany
48"Wx24"Dx29"H, Shpg. Wt. 35 lbs.
LLR 65759‡ Mahogany

LIST PRICE
\$265.00 ea
\$215.00 ea
\$188.00 ea
\$149.00 ea



C.

72" Table in Mahogany

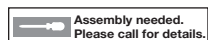

Assembly needed. Please call for details.

‡Cannot be shipped UPS.

FOLDING CHAIRS



- Plastic, metal and upholstered options
- Weight capacity 225 lbs.
- Covered by Lorell Limited 5-Year Warranty



A. Blow Molded Folding Chair

Heavy-duty tubular steel powder coated frame. High-density polyethylene seat and back. 225 lb. capacity. Covered by Lorell Limited 5-Year Warranty. **Four per carton.**

18½"Wx21¾"Dx33¾"H
LLR 62515

Platinum

LIST PRICE
~~\$260.00~~ ct



B. Breathable Mesh Seat And Back Guest Chair

Mesh seat with silver finish base. Stackable and gangable. 225 lb. capacity. Covered by Lorell Limited 5-Year Warranty.

Two per carton.

19"Wx20½"Dx32"H
LLR 60533

Black

LIST PRICE
~~\$325.00~~ ct

C. Steel Folding Chairs

Riveted U-brace front and back. Powder coated beige steel frame. 225 lb. capacity. Covered by Lorell Limited 5-Year Warranty. **Four per carton.**

19"Wx18¾"Dx29¾"H
LLR 62501 Padded Beige Vinyl Seat

LLR 62500 Steel Seat

LIST PRICE

~~\$195.00~~ ct

~~\$149.00~~ ct



Padded Beige Vinyl Seat



Steel Seat



Blueberry/
Black Fabric
w/Charcoal
Frame

D. Upholstered Stack Chairs

Seat is 1½" thick. Rugged 7/8" tubular steel black frame. Can stack up to eight high. Covered by Lorell Limited 5-Year Warranty. Weight Capacity: 250 lbs. max. **Four per carton.**

18"Wx22"Dx35½"H, Shpg. Wt. 53 lbs.
LLR 62513‡ Burgundy With Charcoal Frame

LLR 62514‡ Blueberry/Black Fabric Charcoal Frame

LIST PRICE
~~\$340.00~~ ct
~~\$347.00~~ ct



A. Vinyl Upholstered Stack Chairs

Durable 7/8" tubular steel silver powder coat frame. 2" upholstered seat. Can stack up to eight high. Covered by Lorell Limited 5-Year Warranty. Weight Capacity: 250 lbs. max. **Four per carton.**

18"Wx22"Dx35"H, Shpg. Wt. 54 lbs. LLR 62506‡

Blue

LIST PRICE
~~\$375.00~~ ct



B.



B. Stacking Chairs

All-purpose stacking chairs feature a fabric-covered, padded seat/back and 7/8" tubular steel powder coat silver frame. Stack up to eight high. Covered by Lorell Limited 5-Year Warranty. Weight Capacity: 250 lbs.

Four per carton.

22"Wx18"Dx34 1/2"H, Shpg. Wt. 52 lbs. LLR 62510‡

Blue

LIST PRICE
~~\$350.00~~ ct

C.



C. Vinyl Upholstered Stack Chairs

Dome seat is 1 1/2" thick. Durable 7/8" tubular steel black frame. Can stack up to eight high. Covered by Lorell Limited 5-Year Warranty. Weight Capacity: 250 lbs. max. **Four per carton.**

18"Wx22"Dx34 1/2"H, Shpg. Wt. 54 lbs. LLR 62512‡

Black/Black

LIST PRICE
~~\$285.00~~ ct

D.



E.



D. Plastic Arm Stacking Chairs

Black plastic arm cap. Covered by Lorell Limited 5-Year Warranty. Weight Capacity: 250 lbs. max.

Four per carton.

20 1/4"Wx20 1/2"Dx35 1/2"H, Shpg. Wt. 55 lbs. LLR 62504‡

Black

LIST PRICE
~~\$375.00~~ ct

E. Armless Stacking Chairs

250 lb. capacity. **Four per carton.**

20 1/4"Wx19 1/2"Dx35 1/2"H, Shpg. Wt. 55 lbs. LLR 62502‡

Black

~~\$375.00~~ ct

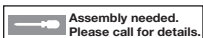

Assembly needed. Please call for details.

‡Cannot be shipped UPS.

RECEPTION/GUEST CHAIRS

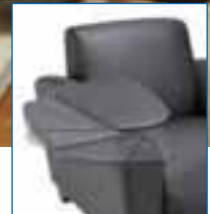

Club Chair with Tablet

LORELL
ACCESSION by Lorell®

- Features bonded leather
- Mahogany-stained legs
- Covered by Lorell Limited 5-Year Warranty

A. Sofa LIST PRICE
 75"Wx34½"Dx31¼"H, Shpg. Wt. 139 lbs.
 LLR 68950‡ Black Leather ~~\$1325.00~~ ea

B. Loveseat
 55"Wx34½"Dx31¼"H, Shpg. Wt. 108 lbs.
 LLR 68951‡ Black Leather ~~\$999.00~~ ea

C. Club Chairs LIST PRICE
 36"Wx34½"Dx31¼"H, Shpg. Wt. 87 lbs.
 LLR 68952‡ Black Leather ~~\$760.00~~ ea
 LLR 68953‡ Black Leather (Tablet Included) ~~\$799.00~~ ea



Midnight Blue/
Cherry Frame



Ruby/
Mahogany Frame



Taupe/
Espresso
Frame

D. Guest Chairs

Thick padded seat and back with built-in lumbar support. Wood base and arms. Chairs are easily assembled without the use of tools due to a unique locking system. Covered by Lorell Limited 5-Year Warranty.

	LIST PRICE
24"Wx25"Dx35½"H LLR 68550 Ruby/Mahogany Frame	\$411.00 ea
LLR 68551 Charcoal/Mahogany Frame	
LLR 68552 Taupe/Cherry Frame	\$411.00 ea
LLR 68553 Midnight Blue/Cherry Frame	
LLR 68554 Taupe/Espresso Frame	\$411.00 ea
LLR 68555 Charcoal/Espresso Frame	

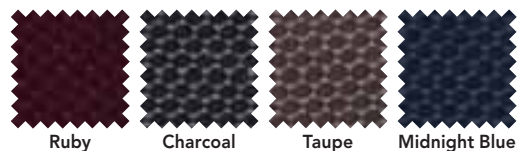



Chair Feature Information for Chairs on pages 30-47

The diagrams below identify those features that best suit your needs. The number key matches the examples found throughout the seating section.

Height & Depth Controls



1. Pneumatic Seat-Height Adjustment
Regulates height of chair relative to floor.

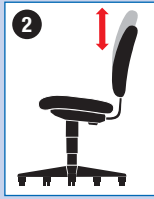

2. Back-Height Adjustment
Positions lumbar support within a fixed range.



3. Seat-Depth Adjustment
Positions chair back relative to seat.



4. Seat Glide Mechanism
Seat cushion travels forward and back, then locks into position.



5. 360 Degree Swivel
Standard on every executive and task chair.



6. Tilt
Pivot point located directly above center of chair base.



7. Mid-Range Knee Tilt
Pivot point located slightly ahead of center of chair base. Allows user to recline at a slightly more relaxed angle than conventional tilt.



8. Knee Tilt
Pivot point located near front edge of chair. Allows user to keep feet flat on floor while chair reclines.



9. Dual-Action Synchro Tilt
Back reclines at a 2-to-1 ratio to seat angle. Allows user to recline while keeping seat cushion relatively level to floor.

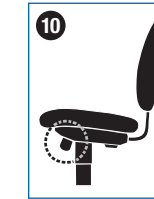

10. Tilt Tension
Controls rate and ease of recline.

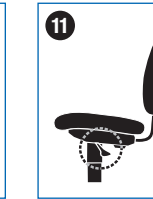

11. Tilt Lock
Locks out tilt function when chair is in upright position.



12. Posture Mechanism/Lock
Back angle adjusts independently of seat, and can be locked in an infinite number of positions.

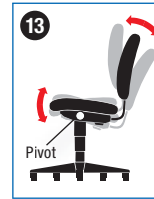

13. Multi-Task Control
Adjusts seat and back angles with a single lever (infinite locking within a fixed range).



14. Asynchronous Control
Three levers modify:
• Angle of back relative to seat
• Tilt (free float or infinite locking within a fixed range)
• Forward tilt

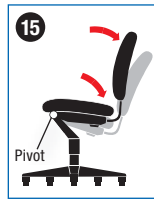

15. Synchronized Knee Tilt
Back reclines at a 2-to-1 ratio to seat angle. Pivot point located near front edge of chair.

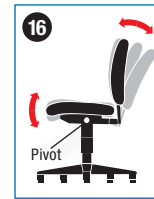

16. Dual-Clutch Posture Control
Adjusts seat and back angles independently with two levers (infinite locking within a fixed range).

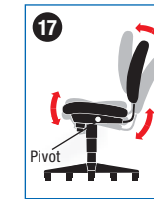

17. Variable Synchro Tilt
Back reclines at a 2-to-1 ratio to the seat. Chair can tilt freely, or lock in position. "Forward angle" control provides an extra 5 degrees in the range of motion.



18. Inverse Synchro Tilt
With automatic tension control opens torso for better circulation. "Zero lift" seat front helps keep feet on the floor when reclining. Tilt limiter controls range of motion.



19. Independent Seat and Back
Seat and back flex independently for automatic comfort



20. Integral Lumbar Support
Easily adjusts to enhance comfort

Arm Options



Fixed Position T-Arms



Loop Arms



Adjustable-Height Arms

Provide improved upper-torso support. Can be adjusted periodically to relieve strain and provide variety.



Adjustable-Width Arms

Quick-adjust design places arms close to body for keyboarding, or out to sides for ease of entry.



Each arm rotates 30 degrees and adjusts 2 1/2" in height. Position inboard for keyboarding, outboard for entry and exit.

MESH CHAIRS



Black Fabric



Black Leather

LORELL® ERGO MESH SERIES SEATING

Mesh back with unique mesh fabric seat. Ergonomically designed back for natural curvature of person's back. Arms are height- and width-adjustable. Covered by Lorell Limited 5-Year Warranty. 

NEW!

A. Executive High-Back Swivel Chair

Synchro tilt mechanism and seat slider. Covered by Lorell Limited 5-Year Warranty.

1 4 5 10 15*

28½"Wx28½"Dx45"H, Shpg. Wt. 48 lbs.
LLR 86205‡ Black Fabric

LLR 86207‡ Black Leather

LLR 86208‡ Black Eco Leather

LIST PRICE

~~\$405.00~~ ea

~~\$457.00~~ ea

~~\$425.00~~ ea

B.



B. High-Back Mesh Chair

Mesh back and seat with plastic coated steel frame. Synchro tilt mechanism and seat slider. Black nylon base. Upholstered headrest. Covered by Lorell Limited 5-Year Warranty.

1 4 5 10 15*
28½"Wx28½"Dx51"H
LLR 60324

Black

LIST PRICE

~~\$535.00~~ ea

C.



C. Managerial High-Back Chair

Multifunction mechanism. Fabric seat. Covered by Lorell Limited 5 year warranty.

1 2 5 6 14*
28½"Wx28½"Dx45"H
LLR 86200

Black

LIST PRICE

~~\$375.00~~ ea

*For a complete listing of chair features, see page 29



A. Managerial Mid-Back Chair 

Multifunction mechanism. Fabric seat. Covered by Lorell Limited 5-Year Warranty.

1 2 5 6 14*
 25½"Wx23½"Dx40½"H
 LLR 86201 Black

LIST PRICE
\$335.00 ea



B. Mesh Guest Chair

Fabric seat. Covered by Lorell Limited 5-Year Warranty.

27"Wx27½"Dx41"H
 LLR 86202 Black

LIST PRICE
\$299.00 ea

C. Training Room Nesting Guest Chair

Mesh back with Black fabric seat. Four legs with swivel casters. Seat flips up for nesting chairs together. Black powder coat frame. Covered by Lorell Limited 5-Year Warranty. **Two per carton.**

24"Wx27"Dx26"H, Shpg. Wt. 63 lbs.
 LLR 84374‡ Black

LIST PRICE
\$259.00 ct



*For a complete listing of chair features, see page 29

 Assembly needed. Please call for details.

‡Cannot be shipped UPS.

MESH CHAIRS

EXECUTIVE MESH CHAIRS

- Mesh back with leather or fabric seat
- Adjustable seat
- Covered by Lorell Limited 5-Year Warranty



A.

NEW!

A. Mesh-Back Executive Chairs

Contemporary ergonomic mesh back to provide exceptional back support and prevent body heat and moisture build up. 27" nylon base and hooded, double wheel casters. Covered by Lorell Limited 5-Year Warranty.

1 5 6 10 11 12*

27"Wx27"Dx40½"H, Shpg. Wt. 49 lbs. LIST PRICE
 LLR 60622‡ Black Fabric Seat \$585.00 ea
 LLR 60623‡ Black Leather Seat

Black Leather Seat



B.

B. Full Function Executive Swivel Chairs

Features multiple adjustments, chrome base and lower back bar. Meets/exceeds applicable ANSI/BIFMA standards. 225 lb. capacity. Covered by Lorell Limited 5-Year Warranty.

1 4 5 6 9 10 11*

28½"Wx28¼"Dx43½"H, Shpg. Wt. 63 lbs.
 LLR 90040‡ Black Leather Back/Leather Seat

LIST PRICE

~~\$725.00~~ ea

LLR 90039‡ Black Mesh Back/Fabric Seat

~~\$702.00~~ ea

LLR 90041‡ Black Mesh Back/Leather Seat

~~\$695.00~~ ea



C.

C. Executive High-Back Chair

Screen back with adjustable lumbar support. Nylon base with aluminum caps. Covered by Lorell Limited 5-Year Warranty.

1 5 6 10 11*

23¾"Wx38½"Dx42¼"H
 LLR 60540
 LLR 60539

Black
 Gray

LIST PRICE

~~\$631.00~~ ea

*For a complete listing of chair features, see page 29



ELEVATE MESH SERIES

- Mesh back with leather seat
- Arm pads with polished aluminum frame and five-star base
- Covered by Lorell Limited 5-Year Warranty

A. Executive High-Back Chair With Headrest

1 5 10 11* LIST PRICE
 24 1/2"Wx23 3/4"Dx52 1/2"H, Shpg. Wt. 45 lbs. \$515.00 ea
 LLR 85035‡ Black

B. Executive Mid-Back Chair

1 2 10 11* LIST PRICE
 24"Wx23 3/4"Dx44 1/2"H, Shpg. Wt. 39.5 lbs. \$478.00 ea
 LLR 85036‡ Black

C. Leather Guest Chair

Chrome cantilever sled base frame with black bonded leather arms.
 22"Wx25"Dx38"H, Shpg. Wt. 30 lbs. \$309.00 ea
 LLR 69517‡ Black

A.



B.



C.



D.



E.



D. Mesh Task Chair

Mesh back with bonded leather seat. Gray powder-coated base and arms. Hooded double wheel casters. Covered by Lorell Limited 5-Year Warranty.

1 5 6 10* LIST PRICE
 25"Wx25"Dx42"H, Shpg. Wt. 29 lbs. \$249.00 ea
 LLR 69518‡ Black

E. Executive Mid-Back Work Chair

Breathable mesh back. Contoured seat with black upholstery. 250 lb. capacity. Covered by Lorell Limited 5-Year Warranty.

1 5 6 10 11* LIST PRICE
 27"Wx26"Dx40 3/4"H \$210.00 ea
 LLR 84868 Black

*For a complete listing of chair features, see page 29

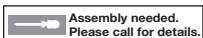

Assembly needed. Please call for details.

‡Cannot be shipped UPS.



BRIDGEMILL LEATHER EXECUTIVE SEATING

- Upholstered in black bonded leather
- Sloped open loop padded leather polished aluminum frame arms
- Matching polished aluminum base with plastic scuff guards
- Covered by Lorell Limited 5-Year Warranty



A. Executive High-Back Chair

1 5 6 10 11*

25½"Wx28"Dx42½"-45¼"H
LLR 60502 Black

LIST PRICE

~~\$464.00~~ ea



B. Managerial Mid-Back Chair

1 5 6 10 11*

25¼"Wx28"Dx37½"-41"H
LLR 60503 Black

LIST PRICE

~~\$415.00~~ ea



C. Guest Chair

24¼"Wx27"Dx35¼"H
LLR 60504 Black

LIST PRICE

~~\$370.00~~ ea



Ridgemoor Leather Executive Seating

Black bonded leather uniquely stitched to provide all day comfort. Ergonomically designed back for lower back comfort. Aluminum open loop frame with padded leather arms. Aluminum five-star base with plastic scuff guards. Covered by Lorell Limited 5-Year Warranty.

D. Executive High-Back Chair

1 5 6 10 11*

26½"Wx29"Dx45¼"-49½"H, Shpg. Wt. 60 lbs.
LLR 60501 Black

LIST PRICE

~~\$585.00~~ ea



Stonebridge Leather Executive Seating

Heavily stitched and tufted back and seat. Back is tailored to provide good lumbar support. Upholstered bonded leather loop arms. Aluminum five-star base with plastic scuff guards. Covered by Lorell Limited 5-Year Warranty.

E. Executive High-Back Chair

1 5 6 10 11*

26½"Wx28¼"Dx44½"-48"H
LLR 60505 Black

LIST PRICE

~~\$501.00~~ ea

*For a complete listing of chair features, see page 29

LORELL
WESTLAKE SERIES

- Features bonded leather upholstery with overstuffed cushions for exceptional comfort
- Waterfall seat and padded arms
- Polyurethane frame in powder coat Champagne or Black finish
- Covered by Lorell Limited 5-Year Warranty



Saddle/
Champagne Finish



Black



Brown/
Black Finish

A. Executive High-Back Chairs

1 5 6 10 11*

26½"Wx28½"Dx43"-46½"H
 LLR 63280
 LLR 63282
 LLR 63286

Saddle/Champagne Finish
 Brown/Black Finish
 Black

LIST PRICE

~~\$395.00~~ ea

B. Managerial Mid-Back Chairs

1 5 6 10 11*

26½"Wx28½"Dx43"H
 LLR 63281
 LLR 63283
 LLR 63287

Saddle/Champagne Finish
 Brown/Black Finish
 Black

LIST PRICE

~~\$375.00~~ ea
~~\$370.00~~ ea



NEW!

C. Executive Eco Leather Chair With Headrest

Padded loop arms with silver coated accents. Built-in lumbar support. Heavy-duty silver coated base with black end caps and dual wheel casters. Coil spring seating comfort. Headrest. Covered by Lorell Limited 5-Year Warranty.

1 5 6 10 11*
 28¾"Wx30" Dx47½"H
 LLR 52120

Black

LIST PRICE

~~\$475.00~~ ea



NEW!

D. Executive Eco Leather Chair

Padded arms and built-in lumbar support. Heavy-duty titanium coated base with dual wheel carpet casters. Coil spring seating comfort. Covered by Lorell Limited 5-Year Warranty.

1 5 6 10 11*
 27½"Wx28¼" Dx46½"H
 LLR 52121

Black

LIST PRICE

~~\$475.00~~ ea

*For a complete listing of chair features, see page 29

Assembly needed. Please call for details.

‡Cannot be shipped UPS.

LEATHER CHAIRS

A.



LORELL HIGH-BACK EXECUTIVE LEATHER CHAIRS

- Leather high-back chairs offer bonded leather upholstery and silver powder-coat arms and base
- Arms are padded for comfort
- Covered by Lorell Limited 5-Year Warranty

NEW!

B.



NEW!

A. High-Back Executive Chair

Features arms that flex when chair is reclined.

1 5 6 10 11*

27"Wx30"Dx46½"H, Shpg. Wt. 49 lbs.
LLR 60620‡ Black And Silver

LIST PRICE

\$475.00 ea

B. High-Back Executive Chair

1 5 6 10 11*

27"Wx30"Dx46½"H, Shpg. Wt. 46 lbs.
LLR 60621‡ Black And Silver

LIST PRICE

\$450.00 ea

C.



EXECUTIVE LEATHER CHAIRS

- Bonded leather with upholstered arms
- Gas lift
- Adjustable tension control
- Covered by Lorell Limited 5-Year Warranty

D.



Black, Silver
Base/Arms

E.



Brown, Pewter
Base/Arms

C. Leather High-Back Executive Chair

Executive chair with bonded black leather. Five-star base. Meets or exceeds applicable ANSI/BIFMA standards. 250 lb. capacity. Covered by the Lorell Limited 5-Year Warranty.

1 5 6 10 11*

28½"Wx27½"Dx45"H,
Shpg. Wt. 52 lbs.
LLR 65961‡

Black

LIST PRICE

\$465.00 ea

D. Classic Executive Chairs

1 5 6 10*

27"Wx32"Dx44½"H, Shpg. Wt. 51 lbs.
LLR 62620‡ Black, Silver Base/Arms
LLR 62621‡ Brown, Pewter Base/Arms

LIST PRICE

\$419.00 ea

E. Low-Back Executive Chairs

1 5 6 10*

27"Wx32"Dx41"H, Shpg. Wt. 51 lbs.
LLR 62622‡ Black, Silver Base/Arms
LLR 62623‡ Brown, Pewter Base/Arms

LIST PRICE

\$399.00 ea

*For a complete listing of chair features, see page 29



TUFTED LEATHER SERIES

- Bonded leather overstuffed cushions
- Waterfall seat design reduces leg fatigue
- Five-star nylon base with dual-wheel casters on the High-Back and Mid-Back Chairs
- Covered by Lorell Limited 5-Year Warranty



A. Executive High-Back Chair

1 5 6 10 11*

25¾"Wx29¾"Dx45½"-49"H, Shpg. Wt. 49 lbs.
LLR 60116‡ Black

LIST PRICE

~~\$365.00~~ ea



B. Managerial Mid-Back Chair

1 5 6 10 11*

25¾"Wx29"Dx38½"-42"H, Shpg. Wt. 43 lbs.
LLR 60115‡ Black

LIST PRICE

~~\$350.00~~ ea



C. Guest Chair

25¾"Wx28¼"Dx40¼"H, Shpg. Wt. 41 lbs.
LLR 60114‡ Black

~~\$314.00~~ ea



D. Leather High-Back Executive Chair

Upholstered, bonded leather chair with gun metal finish on arms and base. Padded arm rest. Powder coated nylon base. 225 lb. capacity. Covered by Lorell Limited 5-Year Warranty.

1 5 6 10 11*

27"Wx30"Dx46½"H, Shpg. Wt. 47 lbs.
LLR 69516‡ Black

LIST PRICE

~~\$420.00~~ ea



E. Mid-Back Chair

Bonded black leather with perforated PVC inset in seat and back. Padded arm rests. Powder coated nylon base. 225 lb. capacity. Covered by Lorell Limited 5-Year Warranty.

1 5 6 10 11*

27"Wx32½"Dx43½"H, Shpg. Wt. 40 lbs.
LLR 69519‡ Black

LIST PRICE

~~\$354.00~~ ea

*For a complete listing of chair features, see page 29

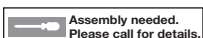

Assembly needed. Please call for details.

‡ Cannot be shipped UPS.

LEATHER CHAIRS

A.



A. Executive Mid-Back Chair

Fully upholstered design with black, bonded leather and black frame. Stylish open loop arms and five-star nylon base with casters. 250 lb. capacity. Covered by the Lorell Limited 5-Year Warranty.

1 5 6 10 11*

26½"Wx27½"Dx38½"-42"H
LLR 84869

Black

LIST PRICE

~~\$195.00~~ ea

B.



B. Leather Mid-Back Chair

Upholstered black, bonded leather. Dacron filled cushions. Padded chrome arms and base. 225 lb. capacity. Covered by Lorell Limited 5-Year Warranty.

1 5 6 10 11*

27"Wx27"Dx42½"H, Shpg. Wt. 53 lbs.
LLR 69515†

Black

LIST PRICE

~~\$410.00~~ ea



CHADWICK SERIES LEATHER CHAIRS

- Fully upholstered with black bonded leather for a rich, classic look
- Open loop arms
- Covered by Lorell Limited 5-Year Warranty

C.



C. Executive High-Back Chair

1 5 6 10*

26"Wx29½"Dx49¾"H
LLR 60120

Black

D.



LIST PRICE

~~\$248.00~~ ea

D. Managerial Mid-Back Chair

1 5 6 10*

26"Wx28"Dx42½"H
LLR 60121

Black

~~\$242.00~~ ea

E.



E. Guest Chair

26"Wx28"Dx35"H
LLR 60122

Black

LIST PRICE

~~\$200.00~~ ea

*For a complete listing of chair features, see page 29



WOODBIDGE SERIES SEATING

- Top grain black leather with rich Cherry or Mahogany finish wood arms and base caps
- Contoured seat and back with built-in lumbar for optimum support
- Covered by Lorell Limited 5-Year Warranty

A.



Mahogany

A. Executive High-Back Chairs

1 5 6 10 11*

26½"Wx30"Dx46¼"H
LLR 60335 Cherry
LLR 60338 Mahogany

LIST PRICE

~~\$581.00~~ ea

B.



Cherry

B. Managerial Mid-Back Chairs

1 5 6 10 11*

26½"Wx28¾"Dx42¼"H
LLR 60336 Cherry
LLR 60339 Mahogany

LIST PRICE

~~\$549.00~~ ea

C.



Cherry

C. Guest Chairs

26"Wx29"Dx37½"H, Shpg. Wt. 47 lbs.
LLR 60337 Cherry
LLR 60340 Mahogany

LIST PRICE

~~\$480.00~~ ea

*For a complete listing of chair features, see page 29

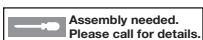

Assembly needed. Please call for details.

‡Cannot be shipped UPS.



BERKELEY SERIES SEATING

- Nail-head trim and deep hand tufting
- Swivel tilt chairs have five-prong steel bases with hardwood caps
- Dark Mahogany finish on all exposed wood
- Vinyl
- Covered by Lorell Limited 5-Year Warranty



A. Executive High-Back Chair

1 5 6 10*

29"Wx32"Dx45"-47"H, Shpg. Wt. 79 lbs.
LLR 60602‡ Burgundy

LIST PRICE

~~\$713.00~~ ea

B. Executive High-Back Chair

1 5 6 10*

30"Wx32"Dx44"-46"H, Shpg. Wt. 79 lbs.
LLR 60603‡ Burgundy

~~\$777.00~~ ea

C. Queen Anne Side Chair

29"Wx30"Dx39½"H, Shpg. Wt. 43 lbs.
LLR 60605‡ Burgundy

~~\$630.00~~ ea

D. Traditional Captain Chair With Casters

26"Wx24"Dx30¾"H
LLR 60601 Burgundy

~~\$415.00~~ ea

E. Traditional Captain Chair

26"Wx24"Dx30¾"H
LLR 60600 Burgundy

~~\$410.00~~ ea



D.



E.



*For a complete listing of chair features, see page 29



ACCORD SERIES TASK SEATING

Contoured molded foam seat and back provide long lasting comfort. Waterfall seat provides under thigh support. 225 lb. capacity. Covered by Lorell Limited 5-Year Warranty.

A.



Black

A. Managerial Task Chairs

1 2 5 10 11 14*

26 3/4" W x 26" D x 48 1/4" - 51" H, Shpg. Wt. 52 lbs. LIST PRICE
 LLR 66153 Black \$412.00 ea
 LLR 66150 Gray

B. Mid-Back Task Chairs

1 2 5 10 11 14*

26 3/4" W x 26" D x 39 1/4" - 42" H, Shpg. Wt. 51 lbs.
 LLR 66128 Black \$370.00 ea
 LLR 66125 Gray

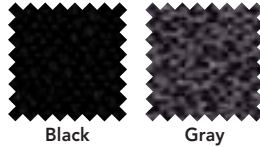

Black

Gray

B.



Gray

C.



Black

Executive Chairs

Molded fabric back and seat. Height adjustable arms with soft pads and weight adjustable syncro-tilt mechanism. Five-star nylon base. 250 lb. capacity. Meets/exceeds applicable ANSI/BIFMA standards. Covered by Lorell Limited 5-Year Warranty.

C. Executive High-Back Chairs

1 5 9*

28 1/2" W x 27 1/4" D x 45 1/2" H, Shpg. Wt. 56 lbs. LIST PRICE
 LLR 66984‡ Black \$409.00 ea
 LLR 66985‡ Gray

D. Executive Mid-Back Chairs

1 5 9*

28 1/2" W x 27 1/4" D x 45 1/2" H, Shpg. Wt. 51 lbs.
 LLR 66986‡ Black \$399.00 ea
 LLR 66987‡ Gray

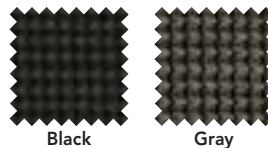

Black

Gray

D.



Gray

*For a complete listing of chair features, see page 29

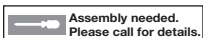

Assembly needed. Please call for details.

‡ Cannot be shipped UPS.

EXECUTIVE ERGONOMIC CHAIRS

LORELL AIRSEAT SERIES

- Airflow fabric is highly breathable
- Back ergonomically designed for lower back comfort
- Aluminum open loop frame with upholstered arms
- Five-star aluminum base with plastic scuff guards
- 225 lb. weight capacity
- Covered by Lorell Limited Lifetime Warranty.



A. Executive High-Back Chair

1 5 6 10*
30½"Wx25½"Dx47"-50½"H
LLR 60500 Black ~~\$428.00~~ ea LIST PRICE



B. High-Performance Ergonomic Chair

Contoured seat and back with built-in lumbar support. Seat slider, forward pitch, two-way adjustable arms and ratchet back. 250 lb. capacity. Covered by Lorell Limited 5-Year Warranty.

1 4 5 6 10 11*
27¼"Wx25½"Dx41½"H
LLR 60535
LLR 60536
LLR 60537
LLR 60538
Gray
Blue
Burgundy
Black LIST PRICE
~~\$399.00~~ ea



C. Bailey Series High-Back Multi-Task Chair

Deep molded seat and back provide added comfort. Pronounced lumbar support with 2" back height adjustment. Adjustable-height and width arms. 225 lb. capacity. Covered by Lorell Limited 5-Year Warranty.

1 2 5 14*
26½"Wx26"Dx39"-42½"H
LLR 81100 Gray
LLR 81101 Blue
LLR 81102 Burgundy
LLR 81103 Black LIST PRICE
~~\$394.00~~ ea



D. High-Performance Ergonomic Chair

Contoured seat and back with built-in lumbar support. Polyurethane adjustable arms. Heavy-duty nylon base with dual-wheel. 225 lb. capacity. Covered by Lorell Limited 5-Year Warranty.

1 5 9 10 11*
27¼"Wx25½"Dx41½"H
LLR 86900 Blue
LLR 86902 Burgundy
LLR 86903 Black LIST PRICE
~~\$381.00~~ ea

*For a complete listing of chair features, see page 29

A.



LORELL®
TASK CHAIRS

- Contoured seat and back
- 225-250 lb. capacity
- Covered by Lorell Limited 5-Year Warranty

NEW!

A. Task Chair

Contoured back and seat. Plastic shell. Five-star nylon base with dual wheel casters. 225 lb. capacity. Covered by Lorell Limited 5-Year Warranty.

1 5 10*
 19"Wx24½"Dx35¾"-40"H
 LLR 84865
 LLR 84870

Blue
 Black

LIST PRICE
\$199.00 ea

B.



**B. Millenia Series
 Pneumatic Task Chairs**

Molded seat and back. Adjustable-height and -width arms included. Arms are removable for classic task use. Height-adjustable back. 250 lb. capacity. Covered by Lorell Limited 5-Year Warranty.

1 2 3 5*
 24"Wx24"Dx33"-38"H
 LLR 80004
 LLR 80005
 LLR 80006
 LLR 80007

Black
 Gray
 Blue
 Burgundy

LIST PRICE

\$210.00 ea

C.



NEW!

C. Multi-Task Chair

Fabric back and seat cushion. Five-star nylon base with dual wheel casters. 225 lb. capacity. Covered by Lorell Limited 5-Year Warranty.

1 5*
 23"Wx24¾"Dx32¾"-37"H
 LLR 84863

Black

LIST PRICE
\$128.00 ea

D.



**D. Heavy Capacity Double Cushion
 Executive Chair**

Bonded leather with double plus cushion seat and back. Two-paddle spring tilt mechanism. Pneumatic gas lift. Adjustable seat height. 3" double wheel casters. **350 lb. capacity.** Covered by Lorell Limited 5-Year Warranty.

1 5*
 33½"Wx31"Dx45½"H, Shpg. Wt. 51 lbs.
 LLR 62624‡

Black

LIST PRICE

\$540.00 ea

*For a complete listing of chair features, see page 29

Assembly needed. Please call for details.

‡Cannot be shipped UPS.

GUEST CHAIRS



DELUXE WOOD FINISH GUEST CHAIRS

Padded faux leather seat and back with built-in lumbar support. Chairs are easily assembled without the use of tools due to a unique locking system. Covered by Lorell Limited 5-Year Warranty.



Black/
Espresso Frame

23"Wx25½"Dx33½"H
LLR 60471
LLR 60470
LLR 60469



Black/
Cherry Frame

Black/Mahogany Frame
Black/Cherry Frame
Black/Espresso Frame



Black/
Mahogany Frame

LIST PRICE

~~\$332.00~~ ea

B.

NEW!



B. Guest Chair

Guest chair with plastic back and chrome finish legs. Padded mesh seat. Covered by Lorell Limited 5-Year Warranty.

Two per carton.

26"Wx25"Dx39"H, Shpg. Wt. 60 lbs.
LLR 52122‡ Black

LIST PRICE

~~\$670.00~~ ct

A. Guest Chair 

Breathable mesh woven back with your choice of padded mesh or faux leather seats. Designed for medium use and rated up to 250 lbs. Covered by Lorell Limited 5-Year Warranty.

24"Wx23½"Dx32¾"H
LLR 60462 Black Faux Leather Seat **LIST PRICE**
~~\$251.35 ea~~



B. Nesting Guest Chair

Mesh back with Black fabric seat. Four legs with swivel casters. Black powder coat frame. Covered by Lorell Limited 5-Year Warranty. **Two per carton.**

24"Wx27"Dx26"H, Shpg. Wt. 63 lbs.
LLR 84374‡ Black **LIST PRICE**
~~\$259.00 ct~~



C. Stackable Guest Chair With Arms

Fully upholstered backs and seats that are cushioned for comfort. Chairs stack four high and feature 1½" hooded dual-wheel casters for easy mobility. Features a steel frame with a black powder-coat finish. 250 lb. capacity. Meets or exceeds applicable ANSI/BIFMA standards. Covered by Lorell Limited 5-Year Warranty. **Two per carton.**

23½"Wx23½"Dx33"H, Shpg. Wt. 25 lbs
LLR 65965‡ Black **LIST PRICE**
~~\$410.00 ct~~

*For a complete listing of chair features, see page 29

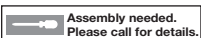

‡Cannot be shipped UPS.

STACK CHAIRS

LORELL STACK CHAIRS

- Stackable up to 4 high
- 250 lb. capacity
- Covered by Lorell Limited 5-Year Warranty

A. Reception Guest Chairs

Contemporary arm style with powder coat steel frame. Molded arm caps. Stackable up to four high. 250 lb. capacity. Covered by Lorell Limited 5-Year Warranty.

23¾"Wx23½"Dx30½"H
LLR 69507
LLR 69508
LLR 69509

Black Vinyl
Black Fabric
Blue Fabric

LIST PRICE
~~\$121.00 ea~~



Shown in Black Vinyl

B.



B. Reception Side Chairs

Painted tubular steel frame. Molded cap arms. Stackable up to four high. Mesh back with fabric waterfall seat. 250 lb. capacity. Covered by Lorell Limited 5-Year Warranty.

23¾"Wx23½"Dx33"H
LLR 69506

Black

LIST PRICE
~~\$110.00 ea~~

C. Stackable Chair

Plastic back and fabric seat chair with chrome finish base. Stackable and gangable. 250 lb. capacity. Covered by Lorell Limited 5-Year Warranty. **Four per carton.**

24"Wx23½"Dx32¼"H
LLR 60543

Black

LIST PRICE
~~\$650.00 ct~~

C.



A.



A. Millenia Task Stools 

Molded seat and back. Adjustable height stool with adjustable chrome footring. Covered by Lorell Limited 5-Year Warranty.

1 2 3 5*

24"Wx24"Dx40½"-50½"H
LLR 80008
LLR 80009
LLR 80010

Black
Gray
Blue

LIST PRICE

~~\$241.00~~ ea

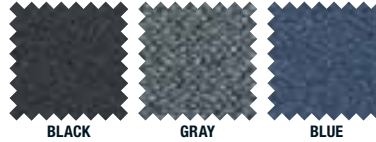

Gray

B.



B. Pneumatic Height Medical Stools

Dual wheel casters. Chrome base. 16" round vinyl covered seat. Back is 10"Hx 16"W. Covered by Lorell Limited 5-Year Warranty.

1 2 3 5*

24"Wx24"Dx36"H
LLR 69511
LLR 69512

Black
Beige

LIST PRICE

~~\$177.00~~ ea

C.



C. Pneumatic Height Medical Stools

Dual wheel casters. Chrome base. 16" round vinyl covered seat. Covered by Lorell Limited 5-Year Warranty.

1 5*

24"Wx24"Dx23"H
LLR 69513
LLR 69514

Black
Beige

LIST PRICE

~~\$140.00~~ ea

*For a complete listing of chair features, see page 29

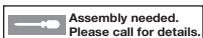

‡Cannot be shipped UPS.

CHAIR ACCESSORIES

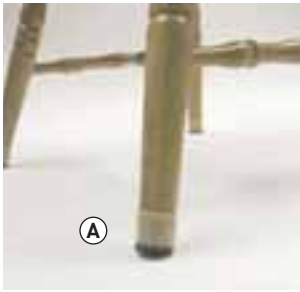

NEW!



A. Clear Sleeve Floor Protectors

Transparent sleeve blends in with most furniture. Flexible sleeve securely forms to size and shape of chair or table leg. Cushioned felt tip lasts longer than standard felt pads. Perfect for restaurants, hotels and areas where esthetics are essential. 8 per pack.

		LIST PRICE
LLR 49320	Fits 7/8" - 1 1/8" round legs, 3/4" square legs	\$17.00 pk
LLR 49321	Fits 1 1/8" - 1 1/4" round legs, 1" square legs	\$19.00 pk



B.



NEW!

B. Chair Tips with Felt

Easy to install. No adhesive required. Protect floor surfaces from scratches and rust stains. Help keep rooms quiet by reducing noise. Reduce chair damage by alleviating stress on joints. Perfect for straight tubular leg furniture. Folding chairs and tables. 16 per bag.

		LIST PRICE
LLR 49322	3/4"	\$30.00 bg
LLR 49323	7/8"	\$34.00 bg
LLR 49324	1"	\$36.00 bg



NEW!



C. Slip-On Floor Savers

Easy to install, extremely durable and no adhesive required. Protect floor surfaces from scratches and rust stains. Help keep rooms quiet by reducing noise when moving chairs and tables. Reduce furniture damage by alleviating stress on joints. Re-engineered to grip leg tighter with a passive locking system. 8 per pack.

		LIST PRICE
LLR 49318	Fits 1"-1 1/8" Round Legs	\$25.00 pk



NEW!

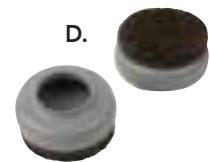

D. Slip Over Floor Saver

Ultra durable, no adhesive is required and easy to install. Protect floor surfaces from scratches and rust stains. Help keep rooms quiet by reducing noise when moving chairs and tables. Reduce furniture damage by alleviating stress on joints. 8 per pack.

		LIST PRICE
LLR 49317	Recommended For Glides 1"-1 1/8" Diameter	\$23.00 pk



NEW!



E. Caster Tire Floor Savers

Fits over existing hard plastic caster wheels. Prevents floor damage and reduces maintenance costs. Casters roll smoothly and quietly. 10 per pack.

		LIST PRICE
LLR 49325	One Size Fits 1 1/4" - 2 1/4" Plastic Casters	\$23.00 pk



NEW!



F. Warp Around Floor Saver

Protect floor surfaces from scratches and rust stains. Dramatically reduces noise and are extremely durable. Easy to apply, peel and stick application. Floor savers conform to the rail for perfect fit and wings attach to themselves for long lasting hold. Recommended for most size rails and can be applied directly to rail or over existing glide. 16 per pack.

		LIST PRICE
LLR 49319	Fits Most Stack Chairs	\$33.00 pk

How To... SELECT THE RIGHT LORELL® CHAIRMAT

Here's what you need to consider:

Determine Your Flooring Type

Once you realize you need a Lorell chairmat, choosing the right one is extremely important. The proper chairmat for your environment will provide years of protection.

Low Pile

1/4"-3/8" thick, including padding such as commercial, rubber backed or Berber

Medium Pile

1/2"-3/4" thick, including padding such as plush carpets

High Pile

Over 3/4" thick, including padding such as deep pile and shag

STEP 1

Floor Type



CARPETED FLOORS

Require a chairmat with bottom studs



HARD FLOORS

Require a non-studded chairmat

	THICKNESS	THICKNESS	THICKNESS	THICKNESS	THICKNESS
HIGH PILE	✓	✓			
MEDIUM PILE			✓	✓	
LOW PILE				✓	✓
HARD FLOOR			✓		✓

← THICKNESS

For best performance, select a thicker mat for heavier weight or high usage



- Extremely durable and resilient
- Designed for any carpet thickness
- Exceptional clarity



- Designed for any carpet thickness

STEP 2 Workspace

SIZE & SHAPE

Measure your allowable rolling distance and pick the shape that best fits your area.

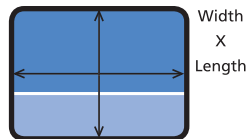

RECTANGLE	LIPPED	WORKSTATION	CONTOUR
Versatile for use with most desks	For use under desks with smaller openings	For use with L-configuration and corner workstations	For use in modern offices



Studded/ Gripper Back

Notched studs grip carpet, but won't pierce or damage carpet backing.



Smooth Edge

Smooth edge for easy-on/easy-off chair movement.

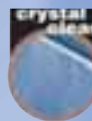

Crystal Clear

Transparent mats let the beauty of your flooring shine through.



Anti-Static

Designed for use with sensitive electronic equipment. Chemically formulated to dissipate static electricity before it has a chance to damage sensitive equipment.

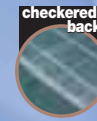

Checked Back

Premium mat features innovative checkered grid on bottom for optimum carpet grip.

A Quick Tip For Measuring Carpet Thickness:

- Straighten the end of a paper clip.
- Sink straightened end of paper clip into the carpet so that it penetrates the carpet backing and reaches to the floor below. (You may have to wiggle the paper clip to force it through the carpet backing).
- Grab the paper clip with your thumb and index finger at the point where it is flush with the top of the carpet. Be sure that you are not matting down the carpet with your hand. Then measure the distance between your fingers and the end of the paper clip.



Why You Need A LORELL® Chairmat...

Extends Carpet Life

Protects carpeting from pulls, tears, wear and divots caused by casters.

Protects Fine Hard Floors

Safeguard wood, tile and ceramic floors from marks caused by casters.

Ergonomic

Provides smooth mobility, reducing the amount of stress on your back.



A. Bamboo Roll-Up Chairmats

- Versatile mats are perfect for both carpet and hard floors
- Felt backing with non-skid gripper dots keeps mat in place
- Rounded edges for easy access on and off the mat
- Rolls up so it's easy to ship and carry
- Finished with premium, eco-preferable, UV-cured coating for ultimate protection
- 100% Moso bamboo is sustainably harvested and supremely durable
- Soft floor casters recommended
- Covered by Lorell Limited 5-Year Warranty



Natural

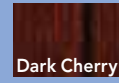

Dark Cherry

Deluxe: 8 mm Thick For Berber Carpet And Hard Floors

Product No.	Color	Description	Size	LIST PRICE
LLR 69526	Natural	Rectangular	48" x 60"	\$298.00 ea
LLR 69527	Dark Cherry	Rectangular	48" x 60"	

Standard: 5 mm Thick For Commercial Carpet And Hard Floors

LLR 69521	Dark Cherry	Wide Lip	55" x 57" 9½" x 23½"	\$299.00 ea
LLR 69520	Natural	Wide Lip	55" x 57" 9½" x 23½"	\$299.00 ea
LLR 69523	Dark Cherry	Wide Lip	44" x 52" 9½" x 23½"	\$276.00 ea
LLR 69522	Natural	Wide Lip	44" x 52" 9½" x 23½"	\$276.00 ea
LLR 69525	Dark Cherry	Rectangular	42" x 48"	\$255.00 ea
LLR 69524	Natural	Rectangular	42" x 48"	

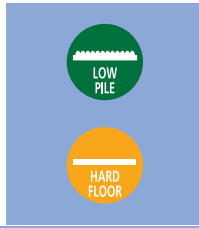

L-Workstation or Corner Chairmat

B. Medium Pile Chairmats

- Smooth edge for easy on-off chair movement
- Crystal clear design and optimal protection
- Covered by Lorell Limited Lifetime Warranty



Product No.	Description	Size	LIST PRICE
LLR 25754‡	Rectangular Lip	46" x 60"	\$140.00 ea
LLR 25757‡	Standard Lip	36" x 48" 19" x 10"	\$98.00 ea
LLR 25756‡	Wide Lip	45" x 53" 25" x 12"	\$105.00 ea
LLR 25755‡	Wide Lip	46" x 60" 25" x 12"	\$132.00 ea
LLR 69156‡	L-Workstation Mat Lip	60" x 66" 20" x 12"	\$195.00 ea



C. Medium Plush Pile Chairmats

Designed for medium pile carpets – thicker mat for better performance
Textured top makes mat slip and scuff resistant
Covered by Lorell Limited Lifetime Warranty



Product No.	Description	Size	LIST PRICE
LLR 69164‡	Rectangular Lip	46" x 60"	\$193.00 ea
LLR 69166‡	Wide Lip	45" x 53" 25" x 12"	\$150.00 ea
LLR 69165‡	Wide Lip	46" x 60" 25" x 12"	\$190.00 ea

A. Low Pile Antistatic Mats

- Reduces risk of shock due to static
- Covered by Lorell Limited Lifetime Warranty



Product No.	Description	Size	LIST PRICE
LLR 25753‡	Rectangular Lip	46" x 60"	\$215.00 ea
LLR 25750‡	Standard Lip	36" x 48" 19" x 10"	\$160.00 ea
LLR 25751‡	Wide Lip	45" x 53" 25" x 12"	\$175.00 ea
LLR 25752‡	Wide Lip	46" x 60" 25" x 12"	\$195.00 ea

B. Economy Chairmats

- Lightweight vinyl construction
- For use on low pile carpet
- Studded with beveled edge
- Covered by Lorell Limited Lifetime Warranty



Product No.	Description	Size	LIST PRICE
LLR 02158‡	Rectangular Lip	46" x 60"	\$92.00 ea
LLR 02156‡	Standard Lip	36" x 48" 19" x 10"	\$62.00 ea
LLR 02157‡	Wide Lip	45" x 53" 25" x 12"	\$73.00 ea

C. Low Pile Chairmats

- Designed and properly weighted for firm, low pile carpets with little or no padding
- Slip- and scuff-resistant
- Beveled edge
- Covered by Lorell Limited Lifetime Warranty



Product No.	Description	Size	LIST PRICE
LLR 69160‡	Rectangular Lip	46" x 60"	\$109.00 ea
LLR 69157‡	Standard Lip	36" x 48" 19" x 10"	\$68.00 ea
LLR 69158‡	Wide Lip	45" x 53" 25" x 12"	\$84.00 ea
LLR 69159‡	Wide Lip	46" x 60" 25" x 12"	\$116.00 ea

D. Hard Floor Chairmat

- Ideal for wood, vinyl and tile floors
- Protects floors from chair scuffs and caster damage
- Straight edge
- No studs
- Covered by Lorell Limited Lifetime Warranty



Product No.	Description	Size	LIST PRICE
LLR 69169‡	Rectangular Lip	46" x 60"	\$105.00 ea
LLR 69167‡	Wide Lip	45" x 53" 25" x 12"	\$91.00 ea
LLR 69168‡	Wide Lip	46" x 60" 25" x 12"	\$109.00 ea

E. Chairmats For Low Pile, Medium Pile And Hard Floors

- Free and Clear formula produces an exceptionally clear vinyl mat that is non-phthalate, non-cadmium and BPA-free
- Protects carpets from wear and tear caused by casters
- Slip- and scuff-resistant
- Rolled and individually boxed to ship UPS
- Covered by Lorell Limited Lifetime Warranty



NEW!

Product No.	Description	Size	Lip	LIST PRICE
For Low Pile Carpeted Floors				
LLR 82821	Rectangular	46" x 60"	-	\$138.00 ea
LLR 82819	Standard Lip	36" x 48"	19" x 10"	\$83.00 ea
LLR 82820	Wide Lip	45" x 53"	25" x 12"	\$106.00 ea
For Medium Pile Carpeted Floors				
LLR 82824	Rectangular	46" x 60"	-	\$157.00 ea
LLR 82822	Standard Lip	36" x 48"	19" x 10"	\$93.00 ea
LLR 82823	Wide Lip	45" x 53"	25" x 12"	\$119.00 ea
For Hard Floors				
LLR 82827	Rectangular	46" x 60"	-	\$82.00 ea
LLR 82825	Rectangular	36" x 48"	-	\$60.00 ea
LLR 82826	Wide Lip	45" x 53"	25" x 12"	\$71.00 ea

Assembly needed. Please call for details. ‡Cannot be shipped UPS.

METAL STORAGE CABINETS



FORTRESS SERIES

- Contemporary three-point recessed locking handle with keys
- Three sets of hinges per door
- Welded steel construction
- Powder coat finish
- 180 lb. capacity per shelf, evenly distributed
- Meets or exceeds ANSI/BIFMA standards
- Covered by Lorell Limited Lifetime Warranty
- Ships assembled

B. 78"H Cabinets

36"Wx24"Dx78"H, Shpg. Wt. 160 lbs.
 LLR 41311‡ Black
 LLR 41310‡ Putty
 LLR 41309‡ Light Gray

LIST PRICE

~~\$703.00~~ ea

72"H Cabinets

36"Wx18"Dx72"H, Shpg. Wt. 131 lbs.
 LLR 41307‡ Putty
 LLR 41308‡ Black
 LLR 41306‡ Light Gray

~~\$574.00~~ ea

42"H Cabinets

36"Wx18"Dx42"H, Shpg. Wt. 84 lbs.
 LLR 41303‡ Light Gray
 LLR 41304‡ Putty
 LLR 41305‡ Black

~~\$434.00~~ ea

B.



78"H Cabinets, Light Gray

NEW!

B.



72"H Cabinets, Black

B.



42"H Cabinets, Putty



FORTRESS SERIES ♻️

- Designed for end tab files, hanging files and three-ring binder filing
- Heavy-duty, three-piece, ball-bearing slide drawer suspension
- Ball-bearing suspension on receding drawer front except on bottom drawer which has a standard fixed front
- Top two drawers on 5-drawer models are binder-height
- Core removable locks. Hang rails included
- Meets/exceeds applicable ANSI/BIFMA standards
- Contains 30% recycled content
- Covered by Lorell Limited Lifetime Warranty.

A.



Black

A.



Putty

A.



Putty

A. Roll-Out Shelf Files With Receding Drawer Fronts

5-Drawer Files

42"Wx18"Dx68"H, Shpg. Wt. 230 lbs.
LLR 43516‡ Putty
LLR 43517‡ Black

LIST PRICE

~~\$1390.00~~ ea

5-Drawer Files

36"Wx18"Dx68"H, Shpg. Wt. 210 lbs.
LLR 43512‡ Putty
LLR 43513‡ Black

~~\$1300.00~~ ea

4-Drawer Files

42"Wx18"Dx52½"H, Shpg. Wt. 195 lbs.
LLR 43514‡ Putty
LLR 43515‡ Black

LIST PRICE

~~\$1100.00~~ ea

4-Drawer Files

36"Wx18"Dx52½"H, Shpg. Wt. 171 lbs.
LLR 43510‡ Putty
LLR 43511‡ Black

~~\$999.00~~ ea

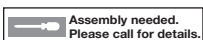

Assembly needed. Please call for details.

‡ Cannot be shipped UPS.

LATERAL FILING



Lateral Filing Units

Hanging file rails included for side-to-side filing in letter, legal, or A4 size. Interlock system allows only one drawer to open at a time. Integrated full steel pull. Counter weight to prevent tipping. Ball-bearing slide suspension. Core removable locks. Adjustable leveling guides. Meets/exceeds applicable ANSI/BIFMA standards. Contains 30% recycled content. Covered by Lorell Limited Lifetime Warranty.



Without Laminate Tops



With (Optional) Laminate Tops



Filing Technique – Advance planning is the key to creating a successful filing and storage system. To determine which system will best meet your filing needs, consider the following three filing options.

How Do You File?	How Can We Help?	What You Need	Where It's Used
Standing Files	Standing files are less expensive, allowing you to use existing folder inventory.	Compressor or following block	<ul style="list-style-type: none"> Vertical files (front-to-back only) Lateral files (side-to-side only in drawers or roll-out shelves) Shelf files (side-to-side only)
Hanging Files	Because hanging files can be viewed from the top, they allow easier organization and identification of file folders. Remaining files hold their place when folders are removed.	Hangrails or high-drawer sides	<ul style="list-style-type: none"> Vertical files (front-to-back only) Lateral files (front-to-back or side-to-side in drawers or roll-out shelves)
End-Tab Files	End-tab files can be viewed from the side, providing the easiest and fastest file identification. Is the preferred solution for healthcare, insurance and other critical files with frequent retrieval.	Front-access shelves to accommodate end-tab files	<ul style="list-style-type: none"> Lateral files (side-to-side only in roll-out shelves or fixed shelves) Shelf files (side-to-side only – ideal for high density)

Ways To Use Lateral Files – Lateral filing is the ideal solution for active workstations, where higher capacity is necessary and retrieval is frequent. The two-drawer steel lateral files are also space-efficient, fitting under standard-height workspaces when used with panel systems.

<p>Front-to-back filing: 30" wide files: 30½" of filing with letter/letter rows 36" wide files: 30½" of filing with letter/letter, legal/legal or letter/legal rows (30" and 36" filing requires LLR 60565 hangrails)</p>	<p>42" wide files: 45¼" of filing with three rows letter or 30½" of two rows legal or two standard printout rows (requires LLR 60565 hangrails)</p>	<p>Side-to-side filing: 30" wide files: 27" of filing with letter or legal 36" wide files: 33" of filing with letter or legal 42" wide files: 39" of filing with letter or legal</p>	<p>Combination filing: (front-to-back with side-to-side in one drawer) 30" wide files: not recommended 36" wide files: 15¼" of front-to-back letter filing and 20¼" of side-to-side legal filing 42" wide files: 15¼" of front-to-back letter filing and 26¼" of side-to-side legal filing</p>
--	---	---	---

LORELL
FORTRESS SERIES

A. Lateral Files

Reinforced base construction for extra strength and rigidity. Dual locking bars. Roll-out binder storage and posting shelf on 5-drawer models. Magnetic label holder for each drawer provided. 36" and 42" wide files feature full-width pull.

5-Drawer

42"Wx18"Dx67½"H, Shpg. Wt. 230 lbs.		LIST PRICE
LLR 60432‡	Putty	\$1461.20 ea
LLR 60433‡	Light Gray	
LLR 60550‡	Black	
36"Wx18"Dx67½"H, Shpg. Wt. 202 lbs.		
LLR 60441‡	Putty	\$1336.40 ea
LLR 60442‡	Light Gray	
LLR 60551‡	Black	

4-Drawer

42"Wx18"Dx52½"H, Shpg. Wt. 195 lbs.		LIST PRICE
LLR 60435‡	Putty	\$1002.56 ea
LLR 60436‡	Light Gray	
LLR 60552‡	Black	
36"Wx18"Dx52½"H, Shpg. Wt. 175 lbs.		
LLR 60444‡	Putty	\$894.40 ea
LLR 60445‡	Light Gray	
LLR 60553‡	Black	

3-Drawer

42"Wx18"Dx40¼"H, Shpg. Wt. 173 lbs.		LIST PRICE
LLR 88030‡	Putty	\$860.00 ea
LLR 88032‡	Light Gray	
LLR 88031‡	Black	
36"Wx18"Dx40¼"H, Shpg. Wt. 153 lbs.		
LLR 88027‡	Putty	\$810.00 ea
LLR 88029‡	Light Gray	
LLR 88028‡	Black	

2-Drawer

42"Wx18"Dx28"H, Shpg. Wt. 148 lbs.		LIST PRICE
LLR 60438‡	Putty	\$669.76 ea
LLR 60439‡	Light Gray	
LLR 60554‡	Black	
36"Wx18"Dx28"H, Shpg. Wt. 123 lbs.		
LLR 60447‡	Putty	\$577.20 ea
LLR 60448‡	Light Gray	
LLR 60555‡	Black	

NEW!



Putty

B. Value Lateral Files

Ball-bearing slide suspension. Core removable locks. Interlock system prohibits the extension of more than one drawer at a time. Meets/exceeds ANSI/BIFMA standards. Contains 30% recycled content. Covered by Lorell Limited Lifetime Warranty.

4-Drawer

30"Wx18"Dx52½"H, Shpg. Wt. 140 lbs.		LIST PRICE
LLR 60559‡	Putty	\$752.00 ea
LLR 60561‡	Light Gray	
LLR 60560‡	Black	

2-Drawer

30"Wx18"Dx28"H, Shpg. Wt. 96 lbs.		LIST PRICE
LLR 60556‡	Putty	\$499.00 ea
LLR 60558‡	Light Gray	
LLR 60557‡	Black	



Light Gray

C.



C. Lateral Files Laminate Tops

Laminate tops for lateral files. Two strips of double-stick laminate tape applied to backside of top to secure to existing file. 3mm edge. Lateral file units sold separately.

42"Wx18"Dx1"H		LIST PRICE
LLR 69025	Mahogany	\$73.00 ea
LLR 69026	Cherry	
36"Wx18"Dx1"H		
LLR 69027	Mahogany	\$65.00 ea
LLR 69028	Cherry	

D. Front-To-Back Rails

For use with lateral files. Front-to-back rails convert side-to-side files to accommodate front-to-back filing and includes four rails per kit. One kit will convert two drawers into front-to-back filing.

		LIST PRICE
LLR 60565	Black	\$32.00 bx

D.



E. Divider Kit

For use with lateral files. Divider kit holds free standing files or binders upright and includes ten dividers per box.

LLR 60564	Black	\$52.00 bx
-----------	-------	-------------------

E.



Assembly needed. Please call for details. ‡Cannot be shipped UPS.



**FORTRESS SERIES
COMMERCIAL GRADE
VERTICAL FILES**

- Steel ball-bearing suspension provides smooth and quiet drawer performance
- Even fully loaded drawers open with ease
- Heavy-gauge steel
- Factory installed core-removable lock
- High-side drawers
- 26½" deep units have an adjustable wire follower
- 28½" deep units feature a full metal follower block and double wall drawer front
- Meets or exceeds ANSI/ BIFMA industry standards
- Recycled with 30% post-consumer materials
- Covered by Lorell Limited Lifetime Warranty



Steel Ball-Bearing Suspension Detail

Putty

Black

Light Gray

A. 26½" Files

Legal-Size 5-Drawer

18"Wx26½"Dx61¾"H, Shpg. Wt. 108 lbs.
LLR 48500‡ Putty
LLR 48501‡ Black
LLR 48502‡ Light Gray

LIST PRICE

\$590.00 ea

Legal-Size 4-Drawer

18"Wx26½"Dx52"H, Shpg. Wt. 86 lbs.
LLR 60197‡ Putty
LLR 60198‡ Black
LLR 60199‡ Light Gray

\$457.60 ea

Legal-Size 2-Drawer

18"Wx26½"Dx28¾"H, Shpg. Wt. 50 lbs.
LLR 60660‡ Putty
LLR 60661‡ Black
LLR 60662‡ Light Gray

\$312.00 ea

Letter-Size 5-Drawer

15"Wx26½"Dx61¾"H, Shpg. Wt. 101 lbs.
LLR 48497‡ Putty
LLR 48498‡ Black
LLR 48499‡ Light Gray

\$525.00 ea

Letter-Size 4-Drawer

15"Wx26½"Dx52"H, Shpg. Wt. 83 lbs.
LLR 60193‡ Putty
LLR 60191‡ Black
LLR 60192‡ Light Gray

\$350.00 ea

Letter-Size 2-Drawer

15"Wx26½"Dx28¾"H, Shpg. Wt. 48 lbs.
LLR 60196‡ Putty
LLR 60194‡ Black
LLR 60195‡ Light Gray

\$239.00 ea

B. 28½" Files

Legal-Size 5-Drawer

18"Wx28½"Dx61¾"H, Shpg. Wt. 111 lbs.
LLR 88048‡ Putty
LLR 88049‡ Black
LLR 88050‡ Light Gray

NEW!

LIST PRICE

\$903.00 ea

Legal-Size 4-Drawer

18"Wx28½"Dx52"H, Shpg. Wt. 91 lbs.
LLR 88045‡ Putty
LLR 88046‡ Black
LLR 88047‡ Light Gray

\$697.00 ea

Legal-Size 2-Drawer

18"Wx28½"Dx28¾"H, Shpg. Wt. 52 lbs.
LLR 88042‡ Putty
LLR 88043‡ Black
LLR 88044‡ Light Gray

\$472.00 ea

Letter-Size 5-Drawer

15"Wx28½"Dx61¾"H, Shpg. Wt. 101 lbs.
LLR 88039‡ Putty
LLR 88040‡ Black
LLR 88041‡ Light Gray

\$772.00 ea

Letter-Size 4-Drawer

15"Wx28½"Dx52"H, Shpg. Wt. 86 lbs.
LLR 88036‡ Putty
LLR 88037‡ Black
LLR 88038‡ Light Gray

\$641.00 ea

Letter-Size 2-Drawer

15"Wx28½"Dx28¾"H, Shpg. Wt. 49 lbs.
LLR 88033‡ Putty
LLR 88034‡ Black
LLR 88035‡ Light Gray

\$436.00 ea

LORELL®
FORTRESS SERIES

A. Commercial Grade Vertical Files

Steel ball-bearing suspension provides smooth and quiet drawer performance. Even fully loaded drawers open with ease. Heavy-gauge steel. Factory installed core-removable lock. Adjustable wire follower keeps files upright. High-side drawers. Meets or exceeds ANSI/BIFMA industry standards. 30% recycled content. Covered by Lorell Limited Lifetime Warranty.

Letter-Size 4-Drawer

15"Wx25"Dx52"H, Shpg. Wt. 78 lbs. LIST PRICE
LLR 60652‡ Putty
LLR 60650‡ Black
LLR 60651‡ Light Gray **\$338.00 ea**

Letter-Size 2-Drawer

15"Wx25"Dx28½"H, Shpg. Wt. 43 lbs.
LLR 60655‡ Putty
LLR 60653‡ Black
LLR 60654‡ Light Gray **\$221.00 ea**



Putty

Light Gray

Black

B.



Putty

Black



Steel Ball-Bearing Suspension Detail

B. 22" Deep Commercial Grade Vertical File Cabinets

Steel ball-bearing suspension provides smooth and quiet drawer performance. High side drawers are ready to accept hanging file folders. Core removable lock. Adjustable wire follower. Meets ANSI/BIFMA industry standards. Contains 30% recycled content. Covered by Lorell Limited Lifetime Warranty.

Letter-Size 4-Drawer

15"Wx22"Dx52"H, Shpg. Wt. 72 lbs. LIST PRICE
LLR 42293‡ Putty
LLR 42294‡ Black
LLR 42295‡ Light Gray **\$284.00 ea**

Letter-Size 2-Drawer

15"Wx22"Dx28½"H, Shpg. Wt. 40 lbs.
LLR 42290‡ Putty
LLR 42291‡ Black
LLR 42292‡ Light Gray **\$180.00 ea**

C.



C. Commercial Grade File Caddy

Make a 2-, 3- or 4-drawer file mobile. Adjusts to fit letter- or legal-size cabinets from 18" to 26½" deep. Easy rolling casters. Contains 30% post-consumer content.

11¾"Wx16"Dx4"H LIST PRICE
LLR 17573 Black **\$59.00 ea**

D.

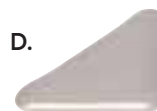

D. File Cabinet Sliders

Slide file cabinets, book cases, safes and other heavy objects effortlessly across carpet and tile surfaces. Sliders are great to reduce rust stains and floor damage associated with moving the item. 4 per bag.

LLR 49326 LIST PRICE
\$22.00 bg



Assembly needed. Please call for details.

‡ Cannot be shipped UPS.

LORELL FORTRESS SERIES

Mobile Pedestal Files

- Pedestal files feature full extension and high-side drawers
- Factory-installed, core-removable locks
- Steel, ball-bearing drawer suspension
- Hidden casters
- Available with recessed or full-width integral drawer pulls
- Meets or exceeds applicable ANSI/BIFMA standards
- Contains 30% recycled content with 30% post-consumer recycled materials
- Covered by Lorell Limited Lifetime Warranty



Black



Putty



Black



Light Gray

Full-Width Integral Pull

A. File/File Pedestals

15"Wx19"Dx27"H, Shpg. Wt. 61 lbs.	LIST PRICE
LLR 49523‡ Putty	
LLR 49524‡ Black	
LLR 49525‡ Light Gray	\$360.00 ea

B. Box/Box/File Pedestals

15"Wx19"Dx27"H, Shpg. Wt. 66 lbs.	
LLR 49520 Putty	
LLR 49521‡ Black	
LLR 49522‡ Light Gray	\$384.00 ea

C. File/File Pedestals

15"Wx22"Dx27"H, Shpg. Wt. 80 lbs.	
LLR 49529‡ Putty	
LLR 49530‡ Black	
LLR 49531‡ Light Gray	\$384.00 ea

D. Box/Box/File Pedestals

15"Wx22"Dx27"H, Shpg. Wt. 86 lbs.	
LLR 49526‡ Putty	
LLR 49527‡ Black	
LLR 49528‡ Light Gray	\$414.00 ea

Recessed Pull

E. File/File Pedestals

15"Wx19"Dx27"H, Shpg. Wt. 61 lbs.	LIST PRICE
LLR 67738‡ Putty	
LLR 67741‡ Black	
LLR 67739‡ Light Gray	\$320.00 ea

F. Box/Box/File Pedestals

15"Wx19"Dx27"H, Shpg. Wt. 66 lbs.	
LLR 67742‡ Putty	
LLR 67745‡ Black	
LLR 67743‡ Light Gray	\$320.00 ea

G. File/File Pedestals

15"Wx22"Dx27"H, Shpg. Wt. 80 lbs.	
LLR 67730‡ Putty	
LLR 67733‡ Black	
LLR 67731‡ Light Gray	\$320.00 ea

H. Box/Box/File Pedestals

15"Wx22"Dx27"H, Shpg. Wt. 86 lbs.	
LLR 67734‡ Putty	
LLR 67737‡ Black	
LLR 67735‡ Light Gray	\$345.00 ea

I.



I. Standard File

Letter-size filing with sliding cover and key lock. Bottom shelf storage. Four dual-wheel casters. Covered by Lorell Limited 5-Year Warranty.

	LIST PRICE
13½"Wx24¾"Dx28¾"H	
LLR 60177 Black, Locking	\$116.00 ea



A. Wire Mail Cart

Top basket can accommodate letter- and legal-size hanging folders. Sturdy bottom basket for larger packages and bulk goods. Heavy-duty steel tubing and wire withstands constant use. Covered by Lorell Limited 5-Year Warranty. **Assembly Required.**

34¼"Wx12½"Dx40"H
LLR 84857

LIST PRICE
\$189.00 ea



B. 3-Tier Rolling Carts

Easy to assemble, no tools required. Two adjustable shelves and one basket with pull handle. Four casters (two locking), provide mobility.

16"Wx26"Dx40"H
LLR 84859
30"Wx18"Dx40"H
LLR 84858

LIST PRICE
\$162.00 ea
\$182.00 ea



C. Mesh Rolling File

Perforated steel rollaway file with open top holds letter-size hanging folders. Bottom shelf for storage. Four casters. Covered by Lorell Limited 5-Year Warranty.

12½"Wx25"Dx28¼"H
LLR 60175

Black

LIST PRICE
\$116.00 ea



D. Letter/Legal Mobile File Cart

Steel wire shelf at bottom with casters, two locking. Covered by Lorell Limited 5-Year Warranty.

12½"Wx25¾"Dx20½"H
LLR 45651

Black

LIST PRICE
\$52.00 ea



E. Compact Mobile Cart

Compact mobile wire filing cart. Holds letter-size hanging files. Powder coated finish. Four swivel dual wheel casters. Includes bottom shelf for additional storage. Covered by Lorell Limited 5-Year Warranty.

15½"Wx14"Dx19½"H
LLR 62950

Black

LIST PRICE
\$45.00 ea



F. 2-Tier Wire File Cart

Letter-size folders can be placed in two rows for front to back filing or one lengthwise row on each file frame. The bottom shelf can be used for storage if additional filing is not needed. Accommodates both letter- and legal-size hanging file folders. Sturdy steel construction with a scratch-resistant powder coat finish. Four swivel casters, two locking. Covered by Lorell Limited 5-Year Warranty.

26"Wx12½"Dx30"H
LLR 45650

Black

LIST PRICE
\$79.00 ea

Assembly needed. Please call for details.

‡Cannot be shipped UPS.

STEEL SHELVING

LORELL
FORTRESS SERIES 

- Riveted Steel Shelving
- Each unit holds a total capacity of 3,800 lbs. of evenly distributed weight
- Heavy-duty riveted steel construction
- Assembles vertically or horizontally to fit most any space
- Sleek black styling with riveted shelf attachments
- Smooth and rust-resistant finish
- Covered by Lorell Limited Lifetime Warranty

A.



48" 5-Shelf

NEW!

B.



36" 5-Shelf

A. 48"Wx24"Dx84"H 

5-Shelf Unit, Shpg. Wt. 116 lbs.
 LLR 60648†

Black

LIST PRICE

\$274.00 ea

48"Wx24"Dx72"H 

5-Shelf Unit, Shpg. Wt. 115 lbs.
 LLR 60624†

Black

\$268.00 ea

48"Wx18"Dx72"H 

5-Shelf Unit, Shpg. Wt. 98 lbs.
 LLR 61622†

Black

\$223.00 ea

B. 36"Wx18"Dx72"H 

5-Shelf Unit, Shpg. Wt. 78 lbs.
 LLR 61621†

Black

LIST PRICE

\$191.00 ea

36"Wx16"Dx72"H 

5-Shelf Unit, Shpg. Wt. 72 lbs.
 LLR 61620†

Black

\$187.00 ea



Shown with Add-On Unit



A. Industrial Wire Shelving

Starter unit includes four shelves and four posts. Ten-gauge shelf surface, three-gauge frame, and six-gauge wave pattern. Supports up to 1,000 lbs. evenly distributed per shelf. 1" shelf adjustments. Units can be expanded with use of add-on units and extra shelves. Uses collar and sleeve lock. Assembly requires no tools. Powder coated paint. Covered by Lorell Limited 5-Year Warranty.

		LIST PRICE
48"Wx24"Dx72"H		
Starter Unit – 4 Shelves/4 Posts LLR 69140‡	Black	\$282.00 ea
Add-On Unit – 4 Shelves/2 Posts LLR 69137‡	Black	\$250.00 ea
2 Extra Shelves LLR 69136‡	Black	\$132.00 ct
48"Wx18"Dx72"H		
Starter Unit – 4 Shelves/4 Posts LLR 70061	Black	\$219.00 ea
Add-On Unit – 4 Shelves/2 Posts LLR 69138‡	Black	\$210.00 ea
2 Extra Shelves LLR 69139‡	Black	\$104.00 ct
36"Wx24"Dx72"H		
Starter Unit – 4 Shelves/4 Posts LLR 69145‡	Black	\$244.00 ea
Add-On Unit – 4 Shelves/2 Posts LLR 69142‡	Black	\$233.00 ea
2 Extra Shelves LLR 69143‡	Black	\$112.00 ct
36"Wx18"Dx72"H		
Starter Unit – 4 Shelves/4 Posts LLR 70060	Black	\$203.00 ea
Add-On Unit – 4 Shelves/2 Posts LLR 69147‡	Black	\$180.00 ea
2 Extra Shelves LLR 69146‡	Black	\$86.00 ct



B. Chrome Wire Shelving

Supports up to 1000 lbs. evenly distributed per shelf. Each shelf adjusts in 1" increments. Shelving is made of steel with a powder coat finish. Covered by Lorell Limited 5-Year Warranty.

		LIST PRICE
48"Wx24"Dx72"H		
Starter Unit – 4 Shelves/4 Posts LLR 84178‡	Chrome	\$357.00 ea
Add-On Unit – 4 Shelves/2 Posts LLR 84179‡	Chrome	\$311.00 ea
2 Extra Shelves LLR 84180‡	Chrome	\$159.00 ct
48"Wx18"Dx72"H		
Starter Unit – 4 Shelves/4 Posts LLR 84181‡	Chrome	\$232.00 ea
Add-On Unit – 4 Shelves/2 Posts LLR 84182‡	Chrome	\$247.00 ea
2 Extra Shelves LLR 84183‡	Chrome	\$122.00 ct
36"Wx24"Dx72"H		
Starter Unit – 4 Shelves/4 Posts LLR 84184‡	Chrome	\$294.00 ea
Add-On Unit – 4 Shelves/2 Posts LLR 84185‡	Chrome	\$256.00 ea
2 Extra Shelves LLR 84186‡	Chrome	\$131.00 ct
36"Wx18"Dx72"H		
Starter Unit – 4 Shelves/4 Posts LLR 84187‡	Chrome	\$222.00 ea
Add-On Unit – 4 Shelves/2 Posts LLR 84188‡	Chrome	\$207.00 ea
2 Extra Shelves LLR 84189‡	Chrome	\$101.00 ct



C. Caster Kit

5" wheel set. Two locking, two non-locking. Includes bumper guards. Covered by Lorell Limited 5-Year Warranty.

		LIST PRICE
LLR 84861‡	Black	\$101.00 st

Assembly needed. Please call for details.

‡Cannot be shipped UPS.

PORCELAIN/HEAVY USE BOARDS



SOPHISTICATED MARKER BOARDS

- Porcelain or heavy use boards
- Solid wood or metal frame
- Covered by Lorell Limited 5-Year Warranty

A. Porcelain Boards

Solid wood trim is a sophisticated blend of materials, adding richness to any environment. Magnetic porcelain steel surface is engineered for superior color contrast with markers and provides smooth writability and easy erasability with no ghosting. TAA compliant. Covered by Lorell Limited 5-Year Warranty.

		LIST PRICE
Cherry Frame		
LLR 55622†	8' x 4'	\$678.00 ea
LLR 55621†	6' x 4'	\$518.00 ea
LLR 55620	4' x 3'	\$259.00 ea
Mahogany Frame		
LLR 55625†	8' x 4'	\$678.00 ea
LLR 55624†	6' x 4'	\$518.00 ea
LLR 55623	4' x 3'	\$259.00 ea
Satin Aluminum Frame		
LLR 55628†	8' x 4'	\$678.00 ea
LLR 55627†	6' x 4'	\$518.00 ea
LLR 55626	4' x 3'	\$259.00 ea

A.



B. Superior Surface Boards

NEW!

Superior wear-resistant surface without ghosting or staining. Smooth writability and easy erasability. Permanently adhered to an insulation board substrate. Covered by Lorell Limited 5-Year Warranty.

		LIST PRICE
Cherry Finish		
LLR 60630†	8' x 4'	\$600.00 ea
LLR 60631†	6' x 4'	\$465.00 ea
LLR 60632†	4' x 3'	\$230.00 ea
Mahogany Finish		
LLR 60633†	8' x 4'	\$600.00 ea
LLR 60634†	6' x 4'	\$465.00 ea
LLR 60635†	4' x 3'	\$230.00 ea
Satin Finish		
LLR 60636†	8' x 4'	\$600.00 ea
LLR 60637†	6' x 4'	\$465.00 ea
LLR 60638†	4' x 3'	\$230.00 ea

B.

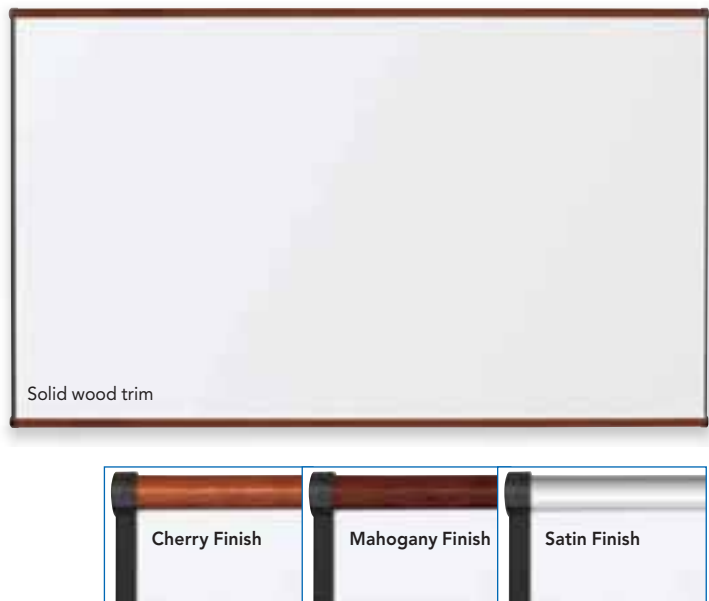

C. Signature Series Heavy-Duty Steel Marker Boards

Magnetic dry erase board with grid lines on 4' x 3' size only. Hanging hardware included. Marker tray included. Covered by Lorell Limited 5-Year Warranty.

		LIST PRICE
Silver/Ebony		
LLR 69654†	8' x 4'	\$580.00 ea
LLR 69653†	6' x 4'	\$450.00 ea
LLR 69652†	4' x 3'	\$242.00 ea

C.





A. Natural Cork Boards

NEW!

Naturally renewable cork surface is durable, self-healing and environmentally responsible. Trim is a sophisticated blend of materials, adding richness to any environment. Covered by Lorell Limited 5-Year Warranty.

		LIST PRICE
Cherry Finish		
LLR 60639‡	8' x 4'	\$345.00 ea
LLR 60640‡	6' x 4'	\$275.00 ea
LLR 60641‡	4' x 3'	\$138.00 ea
Mahogany Finish		
LLR 60642‡	8' x 4'	\$345.00 ea
LLR 60643‡	6' x 4'	\$275.00 ea
LLR 60644‡	4' x 3'	\$138.00 ea
Satin Finish		
LLR 60645‡	8' x 4'	\$345.00 ea
LLR 60646‡	6' x 4'	\$275.00 ea
LLR 60647‡	4' x 3'	\$138.00 ea

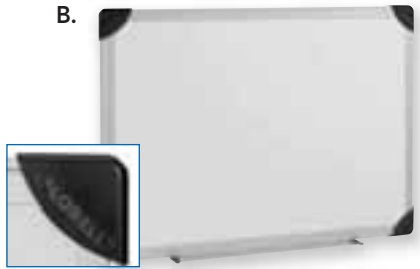

B. Dry-Erase Boards

Laminated styrene dry-erase boards with sturdy aluminum frame. The 4-corner mounting system makes installation simple. Surface resists scratching and ghosting. Marker tray included. Covered by Lorell Limited 5-Year Warranty.

		LIST PRICE
LLR 55654‡	8' x 4'	\$309.75 ea
LLR 55653‡	6' x 4'	\$242.25 ea
LLR 55652‡	4' x 3'	\$109.20 ea
LLR 55651	3' x 2'	\$52.50 ea
LLR 55650	2' x 1½'	\$39.90 ea



C. Aluminum Frame Cork Boards

Thick cork is laminated to sturdy fiberboard with sealed back to provide long-lasting service and prevent warping. Push pins and tacks penetrate easily and hold firmly. Mounting hardware included. Covered by Lorell Limited 5-Year Warranty.

		LIST PRICE
LLR 19194‡	8' x 4'	\$304.50 ea
LLR 19193‡	6' x 4'	\$225.75 ea
LLR 19192‡	4' x 3'	\$93.45 ea
LLR 19191	3' x 2'	\$52.50 ea
LLR 19190	2' x 1½'	\$35.70 ea



D. Combo Boards

Combination board made of half non-magnetic dry-erase and half cork bulletin board. Includes marker tray. Aluminum frame with rounded black corners. Covered by Lorell Limited 5-Year Warranty.

Product No.	Size	LIST PRICE
LLR 19291	3' x 2'	\$55.00 ea
LLR 19290‡	2' x 1½'	\$59.95 ea



E. Mesh Covered Cork Boards

Fabric bulletin board with dense fiberboard back. Aluminum satin anodized frame. Includes hanging hardware. Covered by Lorell Limited 5-Year Warranty.

Aluminum Frame		LIST PRICE
LLR 19203‡	6' x 4'	\$257.25 ea
LLR 19202‡	4' x 3'	\$99.00 ea
LLR 19201‡	3' x 2'	\$63.00 ea
LLR 19200‡	2' x 1½"	\$47.25 ea

Assembly needed. Please call for details. ‡Cannot be shipped UPS.

MARKER & CORK BOARDS & ACCESSORIES

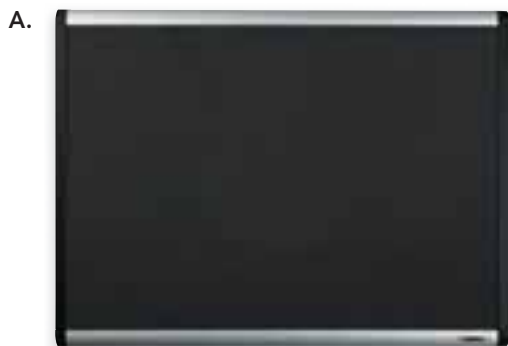

A. Black Mesh Bulletin Boards

Fabric bulletin board with dense fiberboard back. Aluminum satin anodized frame. Includes hanging hardware. Covered by Lorell Limited 5-Year Warranty.

Product No.	Size	LIST PRICE
LLR 75695†	4'x6'	\$285.00 ea
LLR 75696	3'x4'	\$141.00 ea
LLR 75697	3'x2'	\$77.00 ea



NEW!

B. Wood Frame Dry-Erase Boards

Feature Brown wood frames and melamine surface. Marker tray included. Covered by Lorell Limited 5-Year Warranty.

Product No.	Size	LIST PRICE
LLR 84170†	8'x4'	\$324.00 ea
LLR 84169†	6'x4'	\$250.00 ea
LLR 84168†	4'x3'	\$99.00 ea
LLR 84167†	3'x2'	\$53.00 ea



NEW!

C. Combo Dry-Erase Boards

Half non-magnetic dry erase, half cork bulletin board. Includes marker tray. Mahogany frame. Covered by Lorell Limited 5-Year Warranty.

Product No.	Size	LIST PRICE
LLR 84171†	4'x3'	\$114.00 ea
LLR 84270†	24" x 18"	\$38.00 ea



NEW!

D. Cork Rolls & Panels

Natural cork. Covered by Lorell Limited 5-Year Warranty.

Product No.	Description	Size	Packed	LIST PRICE
LLR 84173	Roll	24" x 48"	1	\$14.00 ea
LLR 84172	Panel	12" x 12"	4	\$12.00 pk



E. Dry-Erase Board Eraser

Black plastic top with non-woven cloth. Covered by Lorell Limited 5-Year Warranty.

Product No.	Size	LIST PRICE
LLR 24850	2 $\frac{3}{8}$ "W x 5 $\frac{3}{8}$ "D x 1 $\frac{1}{8}$ "H	\$4.85 ea

F. Assorted Magnets

Clear plastic tub full of 12 small, 12 medium and 6 large magnets in assorted colors (Red, Yellow, Blue and Green). Covered by Lorell Limited 5-Year Warranty.

Product No.	LIST PRICE
LLR 21557	\$6.00 pk





A. Dry-Erase Board Easel

Dry-erase writing surface with accessory tray. Use it as a tabletop or floor standing easel. Rubber feet. Covered by Lorell Limited 5-Year Warranty.

Product No.	Color	Size	LIST PRICE
LLR 75684	Black	40" - 70"H	\$230.00 ea

B.



B. Telescoping Aluminum Easel

Adjustable tubular legs with twist lock design to hold legs in place. Locking cross brace ensures rigidity. Rubber anti-skid feet. Covered by Lorell Limited 5-Year Warranty.

Product No.	Color	Size	LIST PRICE
LLR 75683	Black	66"H	\$86.00 ea

C.



C. Folding Easel

Folds into zip cord satchel for storage and travel. Adjustable display holders lock into place anywhere on easel legs. LLR75680 holds materials up to 10 lbs. LLR75682 holds materials up to 5 lbs. Covered by Lorell Limited 5-Year Warranty.

Product No.	Color	Size	LIST PRICE
LLR 75680	Black	63"H	\$70.00 ea
LLR 75682	Black	63"H	\$46.00 ea

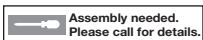

‡Cannot be shipped UPS.

WOOD DESK ORGANIZERS

BAMBOO DESK ACCESSORIES

- Decorate your desk with beautiful accessories that are functional, as well as environmentally-friendly
- These organizers are made of durable bamboo, which is more sustainable and regenerative than traditional hardwood
- Since bamboo is one of the world's fastest growing plants and has a tensile strength comparable to steel, it makes the perfect alternative to hardwood accessories
- Covered by Lorell Limited 5-Year Warranty

A.



A. Front-Load Stackable Letter Trays

Product No. LLR 96528
Size 9½"Wx12½"Dx2"H

LIST PRICE
~~\$63.00~~ **st**

B.



B. Desk Organizer

Product No. LLR 96527
Size 8"Wx7"Dx5"H

LIST PRICE
~~\$41.00~~ **ea**

C.



C. Organizer Sorter

Product No. LLR 96526
Size 8"Wx7"Dx6"H

LIST PRICE
~~\$39.00~~ **ea**

D.



D. Organizer With Drawer

Product No. LLR 96530
Size 13"Wx10¼"Dx5½"H

LIST PRICE
~~\$73.00~~ **ea**

E.



E. Pencil Cup

Product No. LLR 96525
Size 3¼"Wx3¼"Dx4¼"H

LIST PRICE
~~\$21.50~~ **ea**





A.-H. Acrylic Desk Accessories

NEW!

Durable, lightweight design with polished edges that feature a hint of green to emulate the look of real glass. Smooth, curved edges and non-skid feet. Made of durable acrylic. Covered by Lorell Limited 5-Year Warranty.

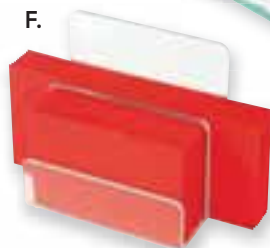
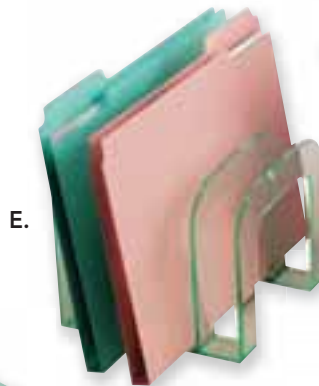
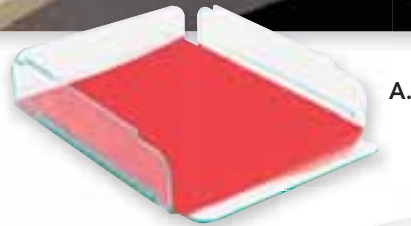
Product No.	Key	Description	LIST PRICE
LLR 80654	A	Stacking Letter Tray	\$27.00 ea
LLR 80655	B	Stacking Letter Tray, 2Pk	\$48.00 ea
LLR 80656	C	Pencil Cup	\$12.00 ea
LLR 80657	D	Business Card Holder	\$8.00 ea
LLR 80658	E	Incline Sorter	\$29.00 ea
LLR 80659	F	Mini Sorter	\$17.00 ea
LLR 80660	G	Paperclip Holder	\$8.00 ea
LLR 80661	H	Phone Stand	\$39.00 ea



 Assembly needed. Please call for details.

‡ Cannot be shipped UPS.

MESH DESKTOP COLLECTIONS



NEW!

BLACK MESH/WIRE DESK ACCESSORIES

Steel mesh or durable wire design. Smooth edges and black powder coat finish. Surface protectors on units where needed. Covered by Lorell Limited 5-Year Warranty.



A. Magazine Holder

10"Wx3½"Dx12¼"H
LLR 84152

LIST PRICE
\$15.00 ea



B.

B. Front-Load Letter Tray

10¾"Wx14¾"Dx11"H
LLR 90206

LIST PRICE
\$27.00 ea



C.

C. Phone Stand

11"Wx10¼"Dx5¼"H
LLR 84155

LIST PRICE
\$13.00 ea



D.

D. Letter Tray

2 per set.
14¼"Wx10¾"Dx3"H
LLR 84154

LIST PRICE
\$22.00 st



E.

E. Sorter

5"Wx3¾"Dx5¼"H
LLR 84153

LIST PRICE
\$9.00 ea



F.

F. Business Card Holder

3¾"Wx2¼"Dx1¼"H
LLR 84151

LIST PRICE
\$5.00 ea



G.

G. Pencil Cup

3½"Wx3¾"H
LLR 84149

LIST PRICE
\$5.00 ea



H.

H. Paper Clip Holder

3¾"Wx3¾"H
LLR 84150

LIST PRICE
\$5.00 ea

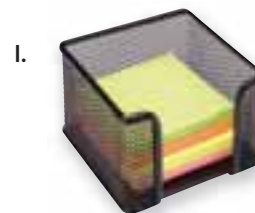

I.

I. Memo Holder

Holds 3x3 notes.

3¾"H
LLR 84156

LIST PRICE
\$6.00 ea



J.

J. Round Waste Bin

12"Wx14¾"H
LLR 52770

LIST PRICE
\$25.00 ea



BLACK MESH/WIRE DESK ACCESSORIES

Steel mesh or durable wire design. Smooth edges and black powder coat finish. Surface protectors on units where needed. Covered by Lorell Limited 5-Year Warranty.



B. Letter File
16½"Wx10"Dx8"H
LLR 84145
LIST PRICE
\$39.00 ea



C. Desk Drawer Organizer
5"Wx2"Dx10¼"H
LLR 84146
LIST PRICE
\$13.00 ea



A. Rectangular Waste Bin
17"Wx10"Dx15¼"H
LLR 52771
LIST PRICE
\$40.00 ea



D. Monitor Stand
20"Wx12"Dx5½"H
LLR 84148
LIST PRICE
\$45.00 ea



E. 6-Vein Sorter
16¼"Wx9"Dx6¼"H
LLR 84157
LIST PRICE
\$34.00 ea



F. Wall Pocket
14"Wx3¾"Dx8¾"H
LLR 84144
LIST PRICE
\$13.00 ea

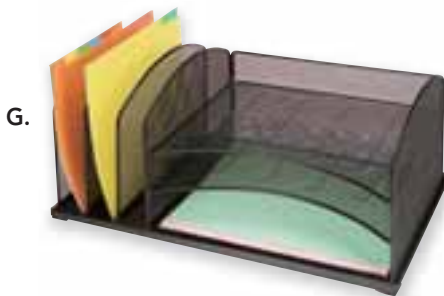

G. Horizontal/Vertical Desktop Organizer
Three 2" horizontal and three 2" vertical upright compartments.
19¾"Wx11¼"Dx8¾"H
LLR 95253
LIST PRICE
\$52.00 ea

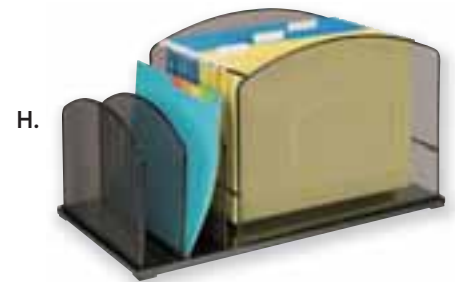

H. Vertical Hanging Organizer
Hanging file frame for letter-size folders with two 2" vertical sorting pockets.
19¾"Wx11¼"Dx11¾"H
LLR 95254
LIST PRICE
\$53.00 ea



I. Multipurpose Desktop Organizer
Features two slide-out baskets to store miscellaneous items and three vertical compartments for files, notebooks and folders.
17"Wx6¾"Dx7¾"H
LLR 21560
LIST PRICE
\$38.00 ea

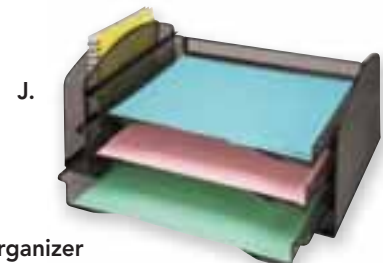

J. Desktop Organizer With Sliding Trays
Features sliding trays for letter-size documents and an upright compartment to fit file folders and slender binders.
16¼"Wx9"Dx8"H
LLR 21562
LIST PRICE
\$56.00 ea

Assembly needed. Please call for details. ‡Cannot be shipped UPS.

MESH DESKTOP COLLECTIONS



BLACK MESH DESK ORGANIZERS

Steel mesh construction with a powder coat finish. Recyclable. Covered by Lorell Limited 5-Year Warranty. Black.

A. Desktop Organizer

Two horizontal letter-size trays and two vertical organizers for folders and binders.

17"Wx10½"Dx8"H
LLR 37526

LIST PRICE
~~\$34.00~~ ea

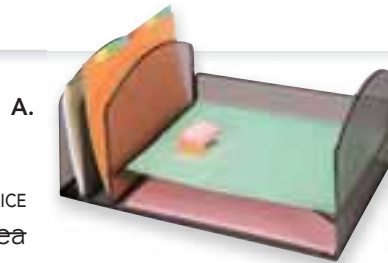

B. 2 & 6 Desk Organizer

B. 2 & 6 Desk Organizer

Two horizontal letter-size compartments and six vertical compartments.

13½"Wx11¼"Dx13¾"H
LLR 37523

LIST PRICE
~~\$50.00~~ ea

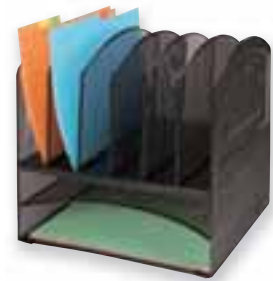

C. Hanging File With Tray Organizer

C. Hanging File With Tray Organizer

Letter-size hanging file with two horizontal letter-size trays.

13½"Wx11¼"Dx15½"H
LLR 37525

LIST PRICE
~~\$47.50~~ ea

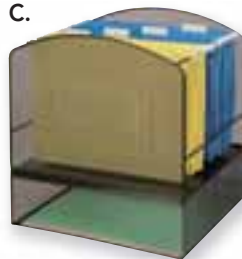

D. 3 & 5 Desk Organizer

D. 3 & 5 Desk Organizer

Three 1" horizontal letter-size pockets and five vertical 1" file compartments.

9½"Wx11¾"Dx13"H
LLR 95255

LIST PRICE
~~\$54.00~~ ea



E. Mini Organizer

Two pockets hold items like pencils, pens, scissors and rulers. Also features a vertical organizer and an open area in front to store small items.

4¾"Wx5½"Dx5¼"H
LLR 37522

LIST PRICE
~~\$10.00~~ ea



F. Deluxe Organizer

F. Deluxe Organizer

Compartments hold items like scissors, pencils, rulers and more. Side compartments hold items like pads, folders and notebooks.

10"Wx5½"Dx5¼"H
LLR 95256

LIST PRICE
~~\$17.00~~ ea



G. Valet

G. Valet

Store cell phones, keys and other items on your desktop. Features a horizontal storage area for notebooks, files and folders.

12¼"Wx6¼"Dx4½"H
LLR 21561

LIST PRICE
~~\$22.00~~ ea



H. Corner Organizer

H. Corner Organizer

Can be used in vertical or horizontal position. Four shelves with two side pockets.

10½"Wx10½"Dx13"H
LLR 95252

LIST PRICE
~~\$39.00~~ ea



I. Organizer With 3 Drawers

I. Organizer With 3 Drawers

Letter tray organizer with one vertical section for files. Three drawers to organize pens, pads and other accessories.

15¼"Wx10¾"Dx7¾"H
LLR 95257

LIST PRICE
~~\$51.00~~ ea



J. Desk Pads

Superior writing surface that will not indent, scratch or stain. The smooth surface reduces writing fatigue. The unique non-glare, non-slip surface provides a perfect way to protect your personal photographs. Resists copy lifting. Clear.

Product No.	Color	Size	LIST PRICE
LLR 39650	Clear	36"Wx20"D	\$39.00 ea
LLR 39651	Matte	36"Wx20"D	
LLR 39652	Clear	24"Wx19"D	\$30.00 ea
LLR 39653	Matte	24"Wx19"D	



NEW!



- Fits all size computers
- From backpack to catalog cases
- Covered by Lorell Limited 5-Year Warranty



A. Laptop Two-Gusset Portfolio

Two file compartments • Lightweight and easy to carry • Front pocket organizer • Made of tough polyester fabric

Product No. LLR 61616	Color Black	Size 16"Wx3"Dx12"H	LIST PRICE \$70.00 ea
--------------------------	----------------	-----------------------	-------------------------------------



B. Laptop Backpack

Lightweight, padded pack holds laptop, files and accessories • Outside zip front pocket organizer • Adjustable padded shoulder straps

Product No. LLR 61615	Color Black	Size 12½"Wx5"Dx17½"H	LIST PRICE \$70.00 ea
--------------------------	----------------	-------------------------	-------------------------------------



C. Expandable Attaché

Expands from 4" to 5" deep • Dual combination locks for security • Full organizer and file pocket • Made of durable vinyl

Product No. LLR 61614	Color Black	Size 17½"Wx4"Dx12½"H	LIST PRICE \$60.00 ea
--------------------------	----------------	-------------------------	-------------------------------------



D. Oversized Rolling Catalog Case

Accommodates ledger books and oversized items • Sturdy push button telescoping handle and built-in wheels • Outside pocket for files and accessories • Made of durable vinyl

Product No. LLR 61613	Color Black	Size 22"Wx14"Dx8"H	LIST PRICE \$160.00 ea
--------------------------	----------------	-----------------------	--------------------------------------



E. Rolling Laptop Catalog Case

Sturdy push-button telescoping handle and built-in wheels • Holds catalogs, binders and files • Outside pockets for files and accessories • Made of durable black vinyl

Product No. LLR 61612	Color Black	Size 18"Wx9"Dx14"H	LIST PRICE \$207.00 ea
--------------------------	----------------	-----------------------	--------------------------------------

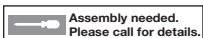

Assembly needed. Please call for details.

‡Cannot be shipped UPS.

PROJECTOR & TV MOUNTS



PROJECTOR & TV MOUNTS

- Fits all size TV's
- Fits VESA and non-VESA mounting patterns
- Covered by Lorell Limited 5-Year Warranty

A.

NEW!

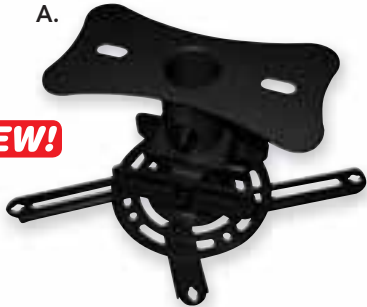

A. Flush Projector Mount

Fits multimedia projectors up to 40 lbs. Flush mounting, only 5.5" from the ceiling. Shift 1.58" left or right. Pitch 0-20° up or down. Roll 0-20° side to side. Rotate 0-60° left or right. Black finish. Covered by Lorell Limited 5-Year Warranty.

Product No.
LLR 39033

LIST PRICE
\$69.00 ea

B.

NEW!



B. Telescopic Projector Mount

Fits multimedia projectors up to 40 lbs. Adjustable drop from 22.6" to 32.5". Ceiling bracket tilts up to 90° for flat or sloped ceiling mounting, or wall mounting. Shift 1.58" left or right. Pitch 0-20° up or down. Roll 0-20° side to side. Rotate 0-60° left or right. Black finish. Covered by Lorell Limited 5-Year Warranty.

Product No.
LLR 39034

LIST PRICE
\$101.00 ea

Projector Not Included

C.



NEW!

C. Large Tilt Mount Combo Pack

The versatile combo pack fits most TV's from 32" to 60" screens up to 77 lbs. The tilt is continuously adjustable from +5° to -15° to create the ideal viewing angle. The universal design fits all VESA and non-VESA mounting patterns up to 600x400 mm. The flush/tilt design allows use as tilt or low profile mount, as it mounts to your TV only 2.05" from wall. Combo pack includes: 6' high speed HDMI with Ethernet, 4 oz screen cleaning solution and microfiber cloth and corner cleaning brush. Covered by Lorell Limited 5-Year Warranty.

Product No.
LLR 39029

LIST PRICE
\$129.00 ea

D.

NEW!

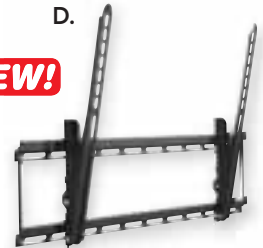

D. Large Tilt Mount

Sleek design will hold most TV's between 32" and 70" (up to 150 lbs.) and features a versatile flush/tilt design that allows it to be used as a tilt or low profile mount. Universal design fits all VESA and non-VESA mounting patterns up to 700x500 mm. Tilt continuously adjustable from 0° to 12°. Mounts only 2.5" from wall. TV interface arms hook on wall bracket for easy installation. Wall bracket dimensions: 31½"Wx9½"H. Open wall bracket design provides easy cable access and routing. Covered by Lorell Limited 5-Year Warranty.

Product No.
LLR 39030

LIST PRICE
\$129.00 ea

E.

NEW!



E. Medium Tilt Mount

Medium low-profile (less than 1.8") tilt mount holds most TV's from 22" to 46" (up to 66 lbs.). The MDST is sturdy, easy-to-install and features double-stud mounting for greater strength and security. Mount tilts from +5° to -15° to give you the ideal viewing angle. May also be used with brick/concrete walls and other wall types. TV interface arms hook onto wall bracket for easy installation, mounting hardware included. Attractive Black finish, universal design fits all VESA and non-VESA mounting patterns up to 400x400 mm. Covered by Lorell Limited 5-Year Warranty.

Product No.
LLR 39027

LIST PRICE
\$79.00 ea



A. Medium Low Profile Mount

Medium low-profile (less than 1") mount holds most TV's from 22" to 46" (up to 66 lbs.). Sturdy, easy-to-install and features double-stud mounting for greater strength and security, yet mounts your TV less than 1" from the wall for a slim sleek look. May also be used with brick/concrete walls and other wall types. TV interface arms hook onto wall bracket for easy installation, mounting hardware included. Attractive Black finish, universal design fits all VESA and non-VESA mounting patterns up to 400x400 mm. Covered by Lorell Limited 5-Year Warranty.

Product No.
LLR 39026

LIST PRICE
\$59.00 ea

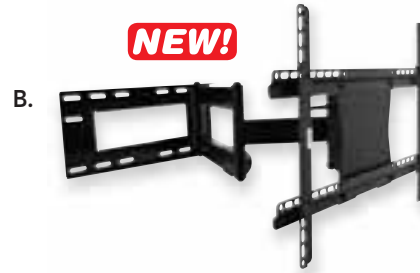

B. Large Double Articulated Mount

Fits most 37"-61" screens (up to 150 lbs.). Low profile design folds flat to wall to save space, yet offers a maximum 28.3" arm extension to allow mounting anywhere, even in or near corners. Large Full Motion Mount offers a tilt angle -15° to +5° so you can create the perfect non-glare viewing angle. Swivels 180° at wall bracket, center pivot and screen. Will fit all VESA mounting patterns from 100x100 mm to 600x400 mm and offers integrated cable management. Completely assembled for fast and easy installation. Covered by Lorell Limited 5-Year Warranty.

Product No.
LLR 39031

LIST PRICE
\$249.00 ea

C. Medium Double Articulated Mount

Value-priced mount with real extension and full motion for 26"-46" flat panel TV's up to 80 lbs. Maximum 20.1" arm extension allows mounting anywhere, even in or near corners, yet folds flat to wall to save space. Tilt angle -15° to +5° allows you to set your ideal viewing angle. Fits all VESA and non-VESA mounting patterns from 100 mm x 100 mm to 400 mm x 400 mm. Screen level adjustment after installation +/-3.5°. Cable management included. Fully assembled with mounting hardware included for fast and easy installation. Covered by Lorell Limited 5-Year Warranty.

Product No.
LLR 39028

LIST PRICE
\$159.00 ea



D. Small/Medium Double Articulated Mount

Value-priced mount with real extension and full motion for 15"-32" flat panel TV's up to 44 lbs. Maximum 15.7" arm extension allows mounting anywhere, even in or near corners, yet folds flat to wall (only 1.38") to save space. Flexible multi-angle position includes 180° swivel at wall bracket, 180° at center pivot and 180° at screen. Tilt angle -15° to +5°. Fits 75x75 mm, 100x100 mm, 200x100 mm and 200x200 mm VESA mounting patterns. Screen level adjustment after installation +/-3°. Fully assembled with mounting hardware included for fast and easy installation. Covered by Lorell Limited 5-Year Warranty.

Product No.
LLR 39025

LIST PRICE
\$89.00 ea

E. Large Ceiling Mount

Perfect for schools, lobbies, conference rooms and many commercial locations where wall mounting is not an option, or ceiling mounting is required to provide high visibility in specific locations. Fits 32"-60" screens up to 125 lbs. Includes many versatile features such as adjustable drop from 37.5" to 60", a ceiling bracket that tilts up to 90° for flat or sloped ceiling mounting or wall mounting, 60° left or right swivel, tilt adjustable from 0° to 12°, and screen leveling adjustment after installation +/-2.5°. Universal design fits all VESA and non-VESA mounting patterns up to 700x500 mm. Heavy-duty construction, easy installation with mounting hardware included and attractive Black finish. Covered by Lorell Limited 5-Year Warranty.

Product No.
LLR 39032

LIST PRICE
\$189.00 ea

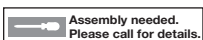

‡ Cannot be shipped UPS.



DESK AND WALL CLOCKS

- Multiple Face Options
- Battery Operated
- Covered by Lorell Limited 5-Year Warranty



A. 14 3/4" Military 12/24 Hour Wall Clock

Radio control movement. Black case with easy to read White dial. Black and Red Arabic numerals. Inside minute track and Red second hand step movement. Runs on one AA battery EVE E91BP2 (not included).

Product No. LLR 60993	Color Black	Size 14 3/4"	LIST PRICE \$52.30 ea
--------------------------	----------------	-----------------	-------------------------------------



B. 10" Quartz Wall Clock

Round Black frame with quartz movement. Black face with White Arabic numerals and Red second hand sweep. Runs on one AA battery EVE E91BP2 (not included).

Product No. LLR 60995	Color Black	Size 10"	LIST PRICE \$21.33 ea
--------------------------	----------------	-------------	-------------------------------------

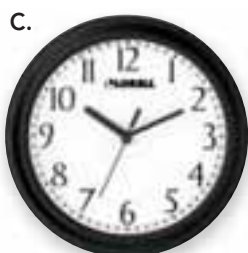

C. 9" Profile Wall Clock

Quartz movement. Black case with easy to read White dial. Arabic numerals, Black second hand sweep. Runs on one AA battery EVE E91BP2 (not included).

Product No. LLR 60987	Color Black	Size 9"	LIST PRICE \$15.99 ea
--------------------------	----------------	------------	-------------------------------------



D. LCD Wall/Alarm Clock

Weekday and weekend alarm with snooze function. Temperature display in C or F with bar chart and 12 hour history. Moon phase and week of the year. Silver ABS casing and Black printed PMMA front lens. Runs on one AA battery EVE E91BP2 (not included).

Product No. LLR 60998	Color Silver & Black	Size 10 1/2"	LIST PRICE \$81.66 ea
--------------------------	-------------------------	-----------------	-------------------------------------

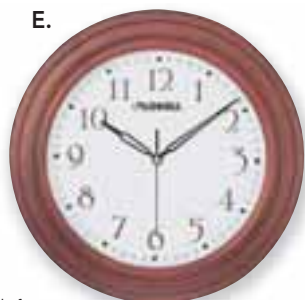

E. 13 1/4" Woodgrain Wall Clock

Quartz movement clock. Mahogany finish frame. Easy-to-read White dial. Arabic numerals, Black second hand sweep. Runs on one AA battery EVE E91BP2 (not included).

Product No. LLR 60988	Color Mahogany	Size 13 1/4"	LIST PRICE \$72.54 ea
--------------------------	-------------------	-----------------	-------------------------------------

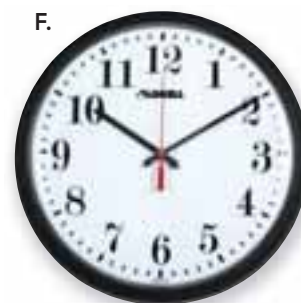

F. 13 1/4" Quartz Wall Clock

Round Black frame with quartz movement. Easy to read White dial, Arabic numerals, Red second hand. Runs on one AA battery EVE E91BP2 (not included).

Product No. LLR 60989	Color Black	Size 13 1/4"	LIST PRICE \$30.99 ea
--------------------------	----------------	-----------------	-------------------------------------



G. Analog Temperature/Humidity Wall Clock

Plastic wall clock with analog temperature and humidity display. Silver ABS hand, Arabic letter face place dimension.

Product No. LLR 61000	Color Silver	Size 12"	LIST PRICE \$80.46 ea
--------------------------	-----------------	-------------	-------------------------------------

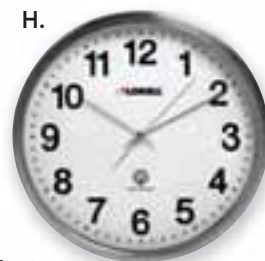

H. Brushed Chrome Frame Atomic Clock

Chrome, nickel-plated iron frame with glass front lens. Silver hands, Silver second hand step. White.

Product No. LLR 61001	Color Chrome	Size 11 3/4"	LIST PRICE \$71.77 ea
--------------------------	-----------------	-----------------	-------------------------------------

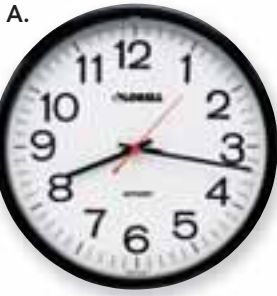

A. 13 1/4" Wall Clock

Round, Black frame. Automatically set by the atomic clock. Easy to read White dial. Arabic numerals. Red second hand sweep. Runs on one AA battery EVE E91BP2 (not included).

Product No. LLR 60994	Color Black	Size 13 1/4"	LIST PRICE \$49.58 ea
--------------------------	----------------	-----------------	-------------------------------------

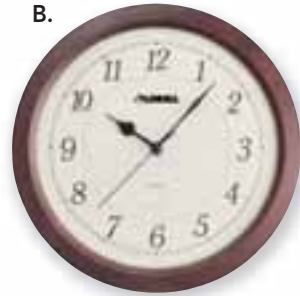

B. 13 1/2" Wood Tone Wall Clock

Round profile wall clock with woodgrain frame. Easy to read White dial. Arabic numerals, Black second hand sweep. Automatically set by the atomic clock. Runs on one AA battery EVE E91BP2 (not included).

Product No. LLR 60986	Color Mahogany	Size 13 1/2"	LIST PRICE \$46.49 ea
--------------------------	-------------------	-----------------	-------------------------------------



C. 12" Wall Clock

Round profile wall clock. Plastic case with White dial, Black numerals and Black second hand sweep. Automatically set by the atomic clock. Runs on one AA battery EVE E91BP2 (not included).

Product No. LLR 60996	Color Silver	Size 12"	LIST PRICE \$42.15 ea
Product No. LLR 60997	Color Black	Size 12"	LIST PRICE \$44.70 ea



E. Atomic Set Alarm Desk Clock

Snooze/light, step second hand. Silver ABS casing and Black printed PMMA front lens. Green luminant PC dial. Runs on one AA battery EVE E91BP2 (not included).

Product No. LLR 60999	Color Silver & Black	Size 5 1/2"W x 2 3/4"D x 5 3/4"H	LIST PRICE \$59.56 ea
--------------------------	-------------------------	-------------------------------------	-------------------------------------



D. 9" Profile Wall Clock

White dial. Arabic numerals, Red second hand sweep. Automatically set by the atomic clock. Runs on one AA battery EVE E91BP2 (not included).

Product No. LLR 60990	Color Black Case With White Dial Black With White Dial	Size 9"	LIST PRICE \$24.42 ea
Product No. LLR 60985	Color White Case, Easy-To-Read White Dial, Black Numerals, Red Second Hand Sweep White With White Dial	Size 9"	LIST PRICE \$25.99 ea



F. Free-Standing, 3-Hook Coat Rack

Sturdy tubular base with hooks.

Assembly required.

Product No. LLR 01580	Color Chrome	Size 69"H	LIST PRICE \$56.00 ea
--------------------------	-----------------	--------------	-------------------------------------

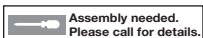

Assembly needed. Please call for details.

‡Cannot be shipped UPS.

CERTIFICATE & PICTURE FRAMES



Walnut

Mahogany



A. Award-A-Plaque

Traditional plaque features protective styrene face and decorative gold tacks. Wood grain look with beveled edges. Includes a usable certificate. Pre-drilled hangers for vertical or horizontal wall display. Holds documents up to 11" x 8½". Covered by Lorell Limited 5-Year Warranty.

Product No.	Color	Size	LIST PRICE
LLR 31886	Walnut	8½" x 11"	\$24.99 ea
LLR 31887	Mahogany	8½" x 11"	



B. Connoisseur Wood Frame

Solid wood document frame with protective plastic front face. Two-way easel back with hangers for convenient desktop or wall display. Usable certificate included. Covered by Lorell Limited 5-Year Warranty.

Product No.	Color	Size	LIST PRICE
LLR 31883	Walnut	8½" x 11"	\$21.99 ea

C. Certificate Of Achievement

Black with gold line. Plastic frame and face. Includes a ready-to-use certificate. Easy in-and-out assembly. Vertical or horizontal display. Covered by Lorell Limited 5-Year Warranty.

Product No.	Color	Size	LIST PRICE
LLR 31885	Black	8½" x 11"	\$7.79 ea



NEW!

D. Multipurpose Frames

Black and gold multipurpose frame with clear protective plastic face. Easy in-and-out assembly. Usable certificate included. Covered by Lorell Limited 5-Year Warranty.

Product No.	Color	Size	LIST PRICE
LLR 31880	Black	8½" x 11"	\$8.49 ea
LLR 31881	Black	8" x 10"	\$7.79 ea



NEW!

E. Floating Frame

Make documents look like they are floating. Each frame hangs vertically or horizontally and contains a Certificate of Excellence. Glass face with black trim. Covered by Lorell Limited 5-Year Warranty.

Product No.	Color	Size	LIST PRICE
LLR 31888	Black	11" x 14"	\$19.29 ea



- Multi speed fans
- Small to large sizes

A. 12" Oscillating Tabletop Fan

Push button control with high, medium and low settings. Oscillation on/off control. High-impact plastic construction with metal safety grill. Super quiet operation. ETL certified. Light Gray.

Product No. LLR 44551 Size 13³/₈"Wx11¹/₂"Dx19¹/₂"H LIST PRICE ~~\$75.45~~ ea



B.

B. 6" Tilt Two Speed Fan

Adjustable tilt head. Metal grill. Three plastic blades UL and cUL approved. 6' cord length 110V AC. Some assembly required. White.

Product No. LLR 49257 Size 7"Wx7³/₈"Dx9¹/₈"H LIST PRICE ~~\$22.00~~ ea



C.

C. 18" Oscillating Pedestal Fan

Powerful motor with large 18" blades for maximum air flow. Push button control with three speed settings and oscillation control. Super quiet operation. Sturdy steel stand with safety grill. UL approved. Light Gray. **Assembly Required.**

Product No. LLR 44550 Size 25³/₈"Wx9³/₈"Dx44"-54"H LIST PRICE ~~\$100.87~~ ea



E.

E. Heavy-Duty Pedestal Fan

Heavy-duty all metal construction with three speed push button control. 20" blade span. 180 degree tilt adjustment. UL Listed. **Assembly required.** Black/Chrome.

Product No. LLR 44555 Size 25"Wx12"Dx51"-63"H LIST PRICE ~~\$231.31~~ ea

Tilts 180°



D.

D. Floor Fan with Remote

Oscillating fan with three speed choices. Infrared ray battery operated remote control four hour timer. Round floor base. Three plastic ABS blades. Batteries included with remote. 16" blade span. ETL approved. White. **Assembly Required.**

Product No. LLR 49251 Size 16"Wx18¹/₄"Dx41"-48"H LIST PRICE ~~\$89.29~~ ea

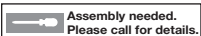

Assembly needed. Please call for details. ‡Cannot be shipped UPS.

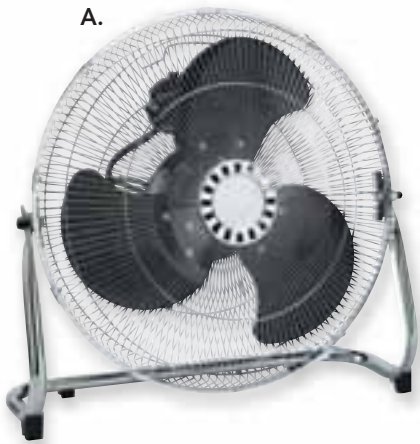

A. Heavy-Duty Floor Fan

Heavy-duty all metal construction with three speed push button control. 18" blade span. 90° tilt adjustment. UL Listed. **Assembly required.** Chrome.

Product No.	Size	LIST PRICE
LLR 44554	23¾"Wx8½"Dx22"H	\$81.52 ea



B. 16" Box Fan

Fan with three speeds. Tilting angle adjustment. 7' power cord. Plastic base and housing. UL/ETL approved. Black.

Product No.	Size	LIST PRICE
LLR 84551	16"Wx19"H	\$81.44 ea



C. 6" Personal Clip-on Fan

Mounts wherever needed. Strong, easy-to-open clamp with rubber grips holds tight while preventing scratches. Two-speed operation. Adjustable tilt mechanism. UL listed. Light Gray.

Product No.	Size	LIST PRICE
LLR 44552	7¾"Wx6"Dx9½"H	\$34.66 ea



D. 16" Wall Mount Fan with Pull Chain

Three speed settings. Single pull chain switch. Oscillating and adjustable tilt head. UL and cUL approved. 6' power cord. 110V AC hardware included for installation. Must be mounted to wood or metal support when attached to drywall. **Assembly required.** White.

Product No.	Size	LIST PRICE
LLR 49256	16"Wx18"H	\$59.00 ea

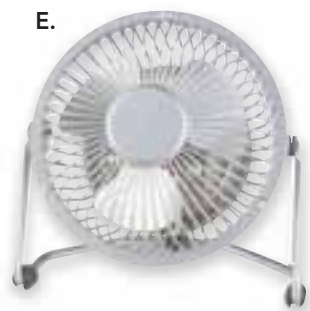

E. 4" High Velocity Fan

Aluminum blades with silver powder coat finish. One speed setting and adjustable tilt head. Rubber feet for quiet operation. Rotary switch. Three wing blades. ETL certified. 6' cord length. 110V AC. Silver.

Product No.	Size	LIST PRICE
LLR 49252	3¾"Wx6¾"Dx7"H	\$32.38 ea

NEW!



F. Adjustable Footrest

Adjustable footrest with large 18" x 14" platform. Elevates feet for personal comfort and to improve circulation. Easy glide design adjusts easily, even when in use. Surface bumps help massage tired feet. Covered by Lorell Limited 5-Year Warranty.

Product No.	Color	Size	LIST PRICE
LLR 42158	Black	18"Wx14"Dx6"H	\$47.00 ea



A. 14" Desktop Oscillating Tower Fan

Three push button speed control. High impact ABS Plastic. ETL certified. White.

Product No.	Size	LIST PRICE
LLR 44557	7½"Wx7½" Dx15" H	\$65.27 ea



B. 32" Oscillating Tower Fan with Remote Control

Space saving three speed tower oscillating fan with remote control. Control your air flow from your chair. Eight hour timer. ETL Certified. Charcoal.

Product No.	Size	LIST PRICE
LLR 44556	9½"Wx9½" Dx32"H	\$102.71 ea



C. 30" Oscillating Tower Fan

Space saving tower design moves air efficiently and quietly. 60° oscillation. Three speeds. Two hour timer. UL listed. Light Gray.

Product No.	Size	LIST PRICE
LLR 44553	9"Wx7"Dx30"H	\$106.65 ea



D. High Velocity Fan

Workshop/utility fan. Three speed. Vertical adjustment with oscillation. Manual control. Plastic injection molded frame. ETL listed.

Product No.	Size	LIST PRICE
LLR 84166	11½"Wx12"Dx18¾"H	\$109.95 ea

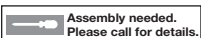

Assembly needed. Please call for details.

‡Cannot be shipped UPS.

LORELL®
HEATERS

- Multiple size heaters
- Fixed and Oscillating

A.



NEW!

A. Ceramic Heater

Radiant digital heater. Two settings plus fan. Good for round year use. Auto shut-off/overheat safety protection. Cool to the touch housing. LED display to show three settings. Blue for fan only. Orange for low. Red for high. White.

Product No.
LLR 84162

Size
9½"Wx6½"Dx11"H

LIST PRICE
~~\$59.99~~ ea

B.



B. PTC Ceramic Heater

Efficient and reliable PTC (Positive Temperature Coefficient) ceramic heater provides instant heat when turned on. After initial startup, heating element becomes virtually self-heating, requiring little electrical current to heat an entire room. Adjustable thermostat maintains desired temperature. Two heat settings plus fan-only setting. Built-in thermal cut-off. Light Gray.

Product No.
LLR 33556

Size
6½"Wx6½"Dx8"H

LIST PRICE
~~\$111.95~~ ea

C.

Recessed
Carrying Handle



NEW!

C. Thermostat Heater

Oscillating for wide heating area. Fan only setting. Adjustable thermostat with fan only. Safety overheat protection. Safety tip over protection. Recessed carry handle. Power indicator light. 900 and 1500 watt settings. Black.

Product No.
LLR 84163

Size
7½"Wx6½"Dx9½"H

LIST PRICE
~~\$49.99~~ ea

D. Four-Setting Portable Heater Fan

Features 500, 1000, 1500-watt and fan only settings. Adjustable thermostat maintains desired temperature. Built-in thermal cut-off. Built-in carrying handle. UL approved. Light Gray.

Product No.
LLR 33551

Size
7½"Wx8½"Dx11"H

LIST PRICE
~~\$55.02~~ ea

D.

Built-in
Carrying Handle





A. Ceramic Tower Heater

Tower unit. Oscillation. Digital thermostat. Safety over-heat protection. Tip over switch. Motion sensor. Remote control. LED display. 12 hour clock. 120V/60hz. Ceramic 23". Black.

Product No.
LLR 84161

Size
8¹⁵/₆₄"Wx8¹⁵/₆₄"Dx23³⁹/₆₄"H

LIST PRICE
~~\$199.00~~ ea

Includes
Remote Control

NEW!



B.



B. Three setting Oil Filled Heater

1500 watt. Adjustable thermostat. Safety overheat protection and casters. Carrying handles. UL approved. Three prong US plug.

Product No.
LLR 29552

Size
14¹/₈"Wx9¹/₂"Dx26"H

LIST PRICE
~~\$149.00~~ ea

C.



C. Microthermic Heater

1500 watt with two heat settings. Digital control with LED display. Temperature settings from 40-95°. 24 hour timer. Remote control. Auto shut off overheat protection. Safety tip over switch. Silent operation. Can be wall mounted (hardware not included). ETL approved. Black/White.

Product No.
LLR 29554

Size
35¹/₈"Wx4¹/₂"Dx22¹/₂"H

LIST PRICE
~~\$162.80~~ ea

D.



NEW!

D. Oscillating Heater

120V/60HZ 900/1500 watt setting heater. 6' power cord. Oscillating for wide area. Fan only setting. Adjustable thermostat. Safety overheat protection. Safety tip over protection. Recessed carry handle. Power indicator light.

Product No.
LLR 84380

Size
7¹/₄"Wx6¹/₈"Dx9¹/₈"H

LIST PRICE
~~\$54.99~~ ea

Assembly needed. Please call for details.

‡ Cannot be shipped UPS.

A.



NEW!



A. 3.3 CU. FT. Compact Refrigerator

Reversible door. Adjustable leveling glides. Recessed handle. Non-locking. Manual defrost. Chiller section. Built in can dispenser. Three interior shelf. Three door shelves. Full range thermo dial control. Flush back. UL approved. Energy star rated.

Product No.
LLR 84379†
LLR 84378†

Color
Black
White

Size
18½" W x 17¾" D x 33¼" H
18½" W x 17¾" D x 32¼" H

LIST PRICE
\$399.00 ea

B.



NEW!

B. 1.6 CU. FT. Compact Refrigerator

Reversible door. Adjustable leveling glides. Recessed handle. Non-locking, manual defrost. Refrigerant R134A. Chiller section. 2 liter bottle rack. Interior shelf. Full range thermo dial control. Flush back. UL approved. Energy Star rated.

Product No.
LLR 84376†
LLR 84377†

Color
White
Black

Size
18½" W x 17¾" D x 19½" H
20¾" W x 18½" D x 20¾" H

LIST PRICE
\$249.99 ea

A

Accessories, Furniture 48
Alarm Clocks 74-75
Attache Cases 71
Award
 Frames 76
 Plaques 76

B

Backpacks, Computer 71
Bases, Table 3, 11, 17, 23-24
Boards
 Bulletin 63-64
 Cork 63-64
 Dry-Erase Easel 65
 Easel 65
 Fabric 64
 Marker 62-64
 Message 64
 Tack 10
Bookcases 3, 5, 7, 11, 15, 18-20, 52
Breakroom Tables 24-25
Bridges 2, 4, 7, 10, 12, 14
Briefcases 71
Bulletin Boards 63-64
Business
 Card Holders 67-68
 Cases 71

C

Cabinet
 Dividers 55
 Doors 14
Cabinets
 Filing 3, 5, 7, 53, 55-58
 Lateral File 3, 55
 Storage 5-6, 52-53
 Vertical File 56-57
Cans, Trash 68-69
Card Holders, Business 67-68
Carts
 File 58-59
 Mail 59
 Service 59
 Utility 59
Cases
 Attache 71
 Book 3, 5, 7, 15, 18-20, 52
 Brief 71
 Business 71
 Computer 71
 Notebook Computer 71
 Travel 71
Casters 61
Center Drawers 14
Certificate Frames 76
Chairmats 50-51
Chairs 37-38
 Conference 3, 23, 27-28, 31,
 34, 37-40, 44-45

Drafting 47
 Executive 3, 30, 32-43
 Folding 26
 Guest 3, 22-24, 26-28, 31,
 33-34, 37-40, 44-46
 Managerial 31, 34-35, 37-39, 41
 Mesh 23, 30, 32, 43
 Reception Room 3, 23, 28, 44-45
 Side 3, 23, 27-28, 31, 34, 37-40, 44-45
 Stacking 22, 24, 26-27, 31, 44-46
 Task 23, 33, 41-43

Clip Dispensers 67-68
Clocks
 Alarm 74-75
 Wall 74-75
Coat Racks 75
Computer
 Cases 71
 Desks 10, 13, 21
 Monitor Risers & Stands 69
 Workstations 9-10, 13, 21
Conference
 Chairs 3, 23, 28, 31, 34, 37-40, 44-45
 Room Furniture 3, 11, 16-17, 22
 Tables 3, 11, 16-17, 22
Cork Boards 63-64
Costumers 75
Counters, Reception 2
Credenzas 2, 6, 9, 12, 14
Cups, Pencil 66
Cushions, Chair 5

D

Desk
 Accessories 66-70
 Connectors 4
 Drawer Organizers 69
 Drawers 14
 Pads 70
 Trays 66-70
Desks 9
 Computer 9-10, 13, 21
 Metal 15
 Wood 2, 4, 6, 9, 14
 Workstation 5
Desktop
 Organizers 66-70
 Sorters 67-70
Dispensers, Paper Clip 67-68
Display Easels 65
Document Frames 76
Doors, Cabinet 14
Drafting Chairs 47
Drawer Organizers 69
Drawers
 Center 14
 Desk 14
Dry-Erase
 Boards 62-64
 Easel Boards 65

E

Easels 65
Ergonomic
 Footrests 78
 Seating 41-43
 Stools 47
Examination Stools 47

F

Fabric Bulletin Boards 64
Fans 77-78, 80
File
 Cabinet Dividers 55
 Cabinet Tops 55
 Cabinets 3, 5, 7, 53, 55-58
 Carts 58-59
 Pockets, Wall 69
 Wall Pockets 69
Files
 Lateral 3, 11, 55
 Magazine 68
 Mobile 58-59
 Pedestal 3, 5, 7, 10, 12-13, 58
 Portable 58-59
 Shelf 53
 Vertical 56-57
 Wall 69
Filing
 Cabinets 3, 5, 7, 53, 55-58
 Desktop 68-70
 Wall Pockets 69
Floor Saver 48
Folding
 Chairs 26
 Tables 25
Footrests 78
Frames
 Award & Certificate 76
 Picture/Document 76
Furniture
 Accessories 48
 Bookcases 3, 5, 7, 15, 18-20, 52
 Cabinet Doors 5, 14
 Chairs 3, 23-24, 26-28, 30-47
 Conference Room 3, 11, 16-17, 22
 Credenzas 2, 6, 9, 14
 Desks 2, 4, 6, 9-10, 13-15, 21
 Filing Cabinets 3, 5, 7, 53, 55-57
 Folding Tables 25
 Hutches 3, 5, 9-10, 14
 Mobile Pedestals 58
 Pedestal Files 3, 5, 7, 10, 58
 Peninsulas 10
 Reception 2
 Reception Room 3, 23, 28, 44-45
 Returns 2, 4, 6-7, 10, 14
 Seating 3, 23-24, 26-28, 30-47
 Shelving 60-61
 Storage Cabinets 3, 5-7, 52-53, 55-57
 Tables 3, 11, 16-17, 22-25

INDEX

- Training Room 23-24
Workstations 2, 7, 10, 13-14, 21
- ## G
- Garment Racks** 75
Guest Chairs 3, 23-24, 26-28, 31, 34, 37-40, 44-46
- ## H
- Heaters** 79, 81
Holders
Business Card 67-68
Memo 68
Note 68
Paper Clip 67-68
Pencil 66
Telephone 67-68
Hutches 3, 5-6, 9-10, 12, 14
- ## I
- Industrial Shelving** 60-61
- ## L
- Lab/Task Stools** 47
Laptop Computer Cases 71
Lateral Files 3, 11, 55
Leg Supports, Furniture 4
Letter Trays 66-69
Literature Files 68
Lobby Boards 64
- ## M
- Magazine Files** 68
Magnetic Bulletin Boards 64
Magnets 64
Mail Carts 59
Markerboards 62-65
Mats, Chair 50-51
Memo Holders 68
Message Boards 64
Metal Desks 15
Mobile
Files 58-59
Utility Carts 59
Monitor Risers & Stands 69
Mounts, Flat Panel TV 72-73
- ## N
- Note Holders** 68
Notebook Computer Cases 71
- ## O
- Office Furnishings**
Computer 10, 13, 21
Credenzas 2, 6, 14
Desks 2, 4, 6, 9-10, 13-15, 21
- Hutches 3, 5, 9-10, 14
Reception Room 3, 23, 28, 44-45
Tables 3, 11, 16-17, 22-25
Workstations 2, 4, 7, 10, 13-14, 21
- ## Organizers
- Desktop 66-70
Drawer 69
- ## P
- Pads, Desk** 70
Paper Clip Dispensers 67-68
Pedestal Files 3, 5, 7, 10, 12-13, 58
Pencil Cups 66-68
Peninsulas 10, 12
Phone Stands 67-68
Photo Frames 76
Picture/Document Frames 76
Plaques, Award 76
Pockets, Wall File 69
Portable Files 58-59
Presentation Easels 65
Projector Stands 72
- ## R
- Racks**
Coat 75
Garment 75
Receptacles, Trash 68-69
Reception Room Furniture 28
Reception Room Seating 3, 23, 28, 44-45
Reception Shelves 2
Recycled Furniture 55-56
Refrigerators 82
Rests, Foot 78
Returns 2, 4, 6-7, 10, 14
Risers, Monitor 69
- ## S
- Seat Cushions** 5
Seating, Reception Room 3, 23, 28, 44-45
Service Carts 59
Shelf Files 53
Shelves
Book 3, 5, 7, 15, 18-20, 52
Reception 2
Storage 3, 5, 9-10, 14
Shelving 60-61
Side Chairs 3, 23, 27-28, 31, 34, 37-40, 44-45
Slide Casters 57
Sofas 28
Sorters Desktop 66-70
Stack-On Shelves 3, 5, 9-10, 14
Stackable Desk Trays 66-69
Stacking Chairs 22, 24, 26-27, 31, 44-46
Stands
Monitor 69
Projector 72
Telephone 67-68
- ## Stools
- 23, 43, 47
- ## Storage
- Cabinets 3, 5-7, 52-53, 55-57
Shelves 3, 5, 9-10, 14, 60-61
- ## T
- Table Bases** 3, 11, 17, 23-24
Tables
Breakroom 24-25
Conference 3, 11, 16-17, 22
Folding 25
Training Room 22-24
Utility 25
Work 24
Tack Boards 10, 63-64
Task
Chairs 23, 41-43
Stools 47
Telephone
Holders 67-68
Stands 67-68
Tops, File Cabinet 55
Training Room Tables 22-24
Trash Cans 68-69
Travel Cases 71
Trays
Desk 66-70
Drawer 69
Stackable 66-68
TV
Mounts 72-73
Wall Mounts 72-73
- ## U
- Utility**
Carts 59
Tables 25
- ## V
- Vertical File Cabinets** 56-57
- ## W
- Wall**
Clocks 74-75
File Pockets 69
Mounts, TV 72-73
Warehouse Shelving 60-61
Waste Containers 68-69
Wastebaskets 68-69
Wheeled Cases 71
Whiteboards 62-64
Wood Desks 2, 4, 6, 9, 14
Workstations 2, 4, 7, 10, 13-14, 21

LORELL® TURNS ANYPLACE INTO A WORKSPACE!

Add a finished look to your Lorell® lateral files with our 69000 series laminate counter tops.



 **LORELL®**

CREATING WHAT WORKS FOR YOU.

Visit our website @www.lorellfurnituredealer.com

LORELL® SEATING.
MAKING ANYWHERE YOU WORK
A LITTLE BETTER.



CREATING WHAT WORKS FOR YOU.

Visit our website @www.lorellfurnituredealer.com

